



US00D943558S

(12) **United States Design Patent** (10) **Patent No.:** **US D943,558 S**  
**Lantz et al.** (45) **Date of Patent:** **\*\* Feb. 15, 2022**

- (54) **HOUSING FOR CEILING ARRAY MICROPHONE**
- (71) Applicant: **Shure Acquisition Holdings, Inc.**,  
Niles, IL (US)
- (72) Inventors: **Gregory William Lantz**, Aurora, IL (US); **John Matthew Miller**, Grayslake, IL (US); **Benjamin Neal Huyck**, Chicago, IL (US)
- (73) Assignee: **Shure Acquisition Holdings, Inc.**,  
Niles, IL (US)
- (\*\*) Term: **15 Years**
- (21) Appl. No.: **29/711,728**
- (22) Filed: **Nov. 1, 2019**
- (51) **LOC (13) Cl.** ..... **14-01**
- (52) **U.S. Cl.**  
USPC ..... **D14/225**; D14/229; D14/209
- (58) **Field of Classification Search**  
USPC ... D14/229, 225, 209, 209.1, 126, 204, 214, D14/210, 211, 219, 221, 250, 224, 224.1,  
(Continued)

- (56) **References Cited**  
**U.S. PATENT DOCUMENTS**  
1,535,408 A \* 4/1925 Fricke ..... G09F 27/00  
40/716  
1,540,788 A \* 6/1925 McClure ..... E04C 2/422  
52/799.12  
(Continued)

- FOREIGN PATENT DOCUMENTS**  
CA 2838856 A1 12/2012  
CA 2846323 A1 9/2014  
(Continued)

- OTHER PUBLICATIONS**  
Order, Conduct of the Proceeding, *Clearone, Inc. v. Shure Acquisition Holdings, Inc.*, Nov. 2, 2020, 10 pp.  
(Continued)

*Primary Examiner* — Paula Allen Greene  
(74) *Attorney, Agent, or Firm* — Neal, Gerber & Eisenberg LLP

(57) **CLAIM**

The ornamental design for a housing for a ceiling array microphone, as shown and described.

**DESCRIPTION**

FIG. 1 is a front perspective view of a housing for a ceiling array microphone;  
 FIG. 2 is a rear perspective view thereof;  
 FIG. 3 is a side elevation view thereof, the other side elevation view and two end elevation views being identical thereto;  
 FIG. 4 is a rear plan view thereof;  
 FIG. 5 is a front plan view thereof;  
 FIG. 6 is an enlarged cross-sectional view thereof taken in the direction of line 6-6 of FIG. 2, shown in an environment of use;  
 FIG. 7 is a front perspective view of the housing in FIG. 1, shown in an environment of use;  
 FIG. 8 is a rear perspective view thereof, shown in an environment of use;  
 FIG. 9 is a side elevation view thereof, the other side elevation view and two end elevation views being identical thereto, shown in an environment of use;  
 FIG. 10 is a rear plan view thereof, shown in an environment of use;  
 FIG. 11 is a front plan view thereof, shown in an environment of use; and,  
 FIG. 12 is an enlarged cross-sectional view taken in the direction of line 12-12 of FIG. 8, shown in an environment of use.  
 The broken lines in FIGS. 1 through 12 that show portions of the housing for ceiling array microphone form no part of the claimed design. The broken lines in FIGS. 6 through 12 that represent the ceiling form no part of the claimed design.

**1 Claim, 12 Drawing Sheets**

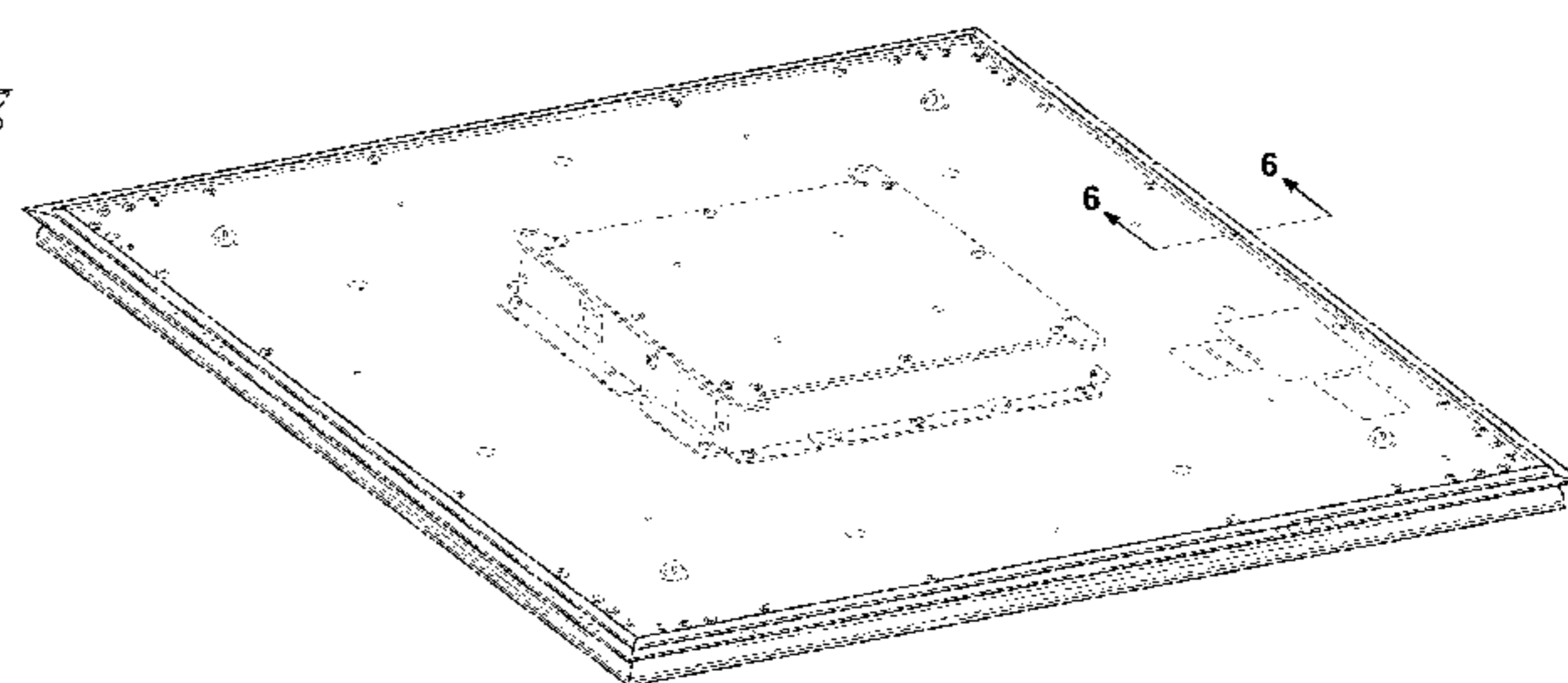
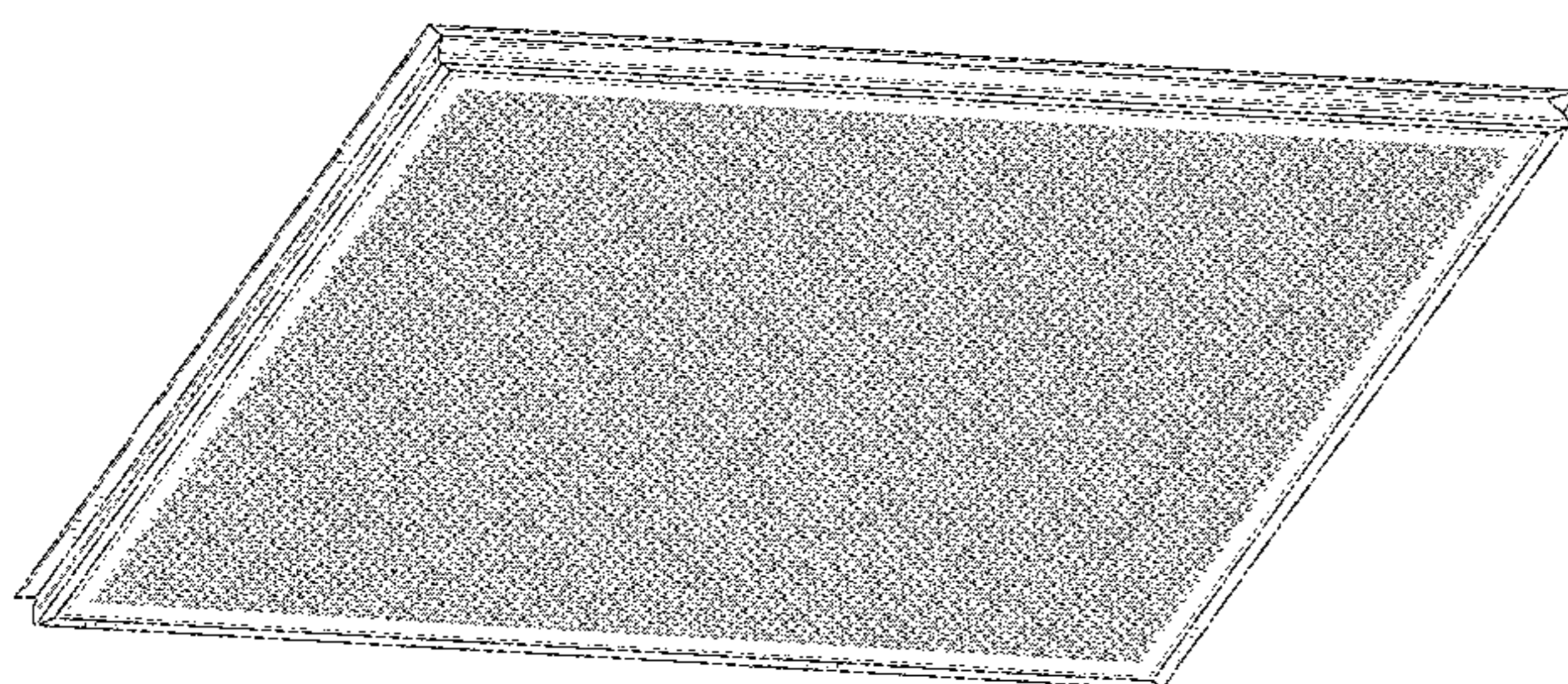

# US D943,558 S

<p>(58) <b>Field of Classification Search</b>          USPC ..... D14/226; D23/388; D6/300, 308;                            D20/43; 181/150; 381/391, 189;                            248/250, 220.22; 312/114; 40/793, 647,                                            40/790; 52/764          CPC . H04R 1/02; H04R 25/00; H04R 5/02; H04R                    1/20; H04R 9/06; H04R 1/24; H04R                    7/18; H05K 5/00; G10K 11/00; G09F                                            3/00          See application file for complete search history.</p>	<p>D345,346 S    3/1994 Alfonso          D345,379 S    3/1994 Chan          5,322,979 A    6/1994 Cassity          5,359,374 A   10/1994 Schwartz          5,383,293 A    1/1995 Royal          5,400,413 A    3/1995 Kindel          D363,045 S   10/1995 Phillips          5,509,634 A *  4/1996 Gebka ..... G09F 3/204            24/336          5,645,257 A *  7/1997 Ward ..... A47B 57/565            108/108          5,717,171 A *  2/1998 Miller ..... H04R 1/023            181/150</p>	<p>D392,977 S    3/1998 Kim          D394,061 S    5/1998 Fink          5,870,482 A    2/1999 Loeppert          5,888,412 A    3/1999 Sooriakumar          5,888,439 A *  3/1999 Miller ..... H04R 1/023            264/248          6,035,962 A    3/2000 Lin          6,039,457 A *  3/2000 O'Neal ..... F21S 8/00            362/217.16          D424,538 S    5/2000 Hayashi          D432,518 S   10/2000 Muto          6,144,746 A   11/2000 Azima          6,198,831 B1   3/2001 Azima          6,205,224 B1   3/2001 Underbrink          6,266,427 B1   7/2001 Mathur          6,285,770 B1   9/2001 Azima          D453,016 S    1/2002 Nevill          6,393,129 B1   5/2002 Conrad          6,488,367 B1   12/2002 Debesis          D480,923 S *  10/2003 Neubourg ..... D7/554.3          6,665,971 B2 * 12/2003 Lowry ..... G09F 3/20            40/642.02          D489,707 S    5/2004 Kobayashi          D504,889 S    5/2005 Andre          6,944,312 B2 * 9/2005 Mason ..... H04R 1/025            381/189          6,993,145 B2   1/2006 Combest          D526,643 S    8/2006 Ishizaki          D527,372 S    8/2006 Allen          D542,543 S    5/2007 Bruce          D546,318 S    7/2007 Yoon          D547,748 S    7/2007 Tsuge          D549,673 S    8/2007 Niitsu          D552,570 S   10/2007 Niitsu          D559,553 S    1/2008 Mischel          D566,685 S    4/2008 Koller          7,387,151 B1 * 6/2008 Payne ..... E06B 5/006            160/371          D587,709 S    3/2009 Niitsu          D589,605 S    3/2009 Reedy          7,536,769 B2   5/2009 Pedersen          D595,736 S    7/2009 Son          7,565,949 B2   7/2009 Tojo          D613,338 S    4/2010 Marukos          7,701,110 B2   4/2010 Fukuda          D614,871 S    5/2010 Tang          D636,188 S    4/2011 Kim          D642,385 S    8/2011 Lee          8,064,629 B2   11/2011 Jiang          D656,473 S *  3/2012 Laube ..... D14/126          8,213,634 B1   7/2012 Daniel          8,286,749 B2   10/2012 Stewart          8,297,402 B2   10/2012 Stewart          8,403,107 B2   3/2013 Stewart          D685,346 S    7/2013 Szymanski          8,479,871 B2   7/2013 Stewart          8,631,897 B2   1/2014 Stewart          8,670,581 B2   3/2014 Harman          8,672,087 B2   3/2014 Stewart          D717,272 S    11/2014 Kim          D718,731 S *  12/2014 Lee ..... D14/126          D725,059 S *  3/2015 Kim ..... D14/126          D725,631 S    3/2015 McNamara          D726,144 S    4/2015 Kang          D729,767 S    5/2015 Lee</p>
<p>(56) <b>References Cited</b>          U.S. PATENT DOCUMENTS</p>	<p>1,965,830 A    7/1934 Hammer          2,075,588 A *  3/1937 Meyers ..... A47G 1/0605            40/790          2,164,655 A *  7/1939 Kleerup ..... G03D 15/10            156/492          D122,771 S *  10/1940 Doner ..... D6/300          2,233,412 A *  3/1941 Hill ..... E06B 9/52            160/378          2,343,037 A *  2/1944 Adelman ..... E06B 9/52            160/381          2,377,449 A *  6/1945 Prevette ..... E06B 9/52            160/106          2,481,250 A *  9/1949 Schneider ..... F02N 15/063            74/7 R          2,521,603 A    9/1950 Prew          2,533,565 A *  12/1950 Eichelman ..... G09F 15/0025            40/603          2,840,181 A *  6/1958 Wildman ..... H04R 1/288            181/199          2,882,633 A *  4/1959 Howell ..... G09F 15/0018            40/793          2,912,605 A   11/1959 Tibbetts          2,938,113 A    5/1960 Schnell          3,019,854 A    2/1962 OBryant          3,143,182 A    8/1964 Sears          3,160,225 A *  12/1964 Sechrist ..... H04R 1/2857            181/151          3,161,975 A   12/1964 McMillan          3,205,601 A    9/1965 Gawne          3,310,901 A *  3/1967 Sarkisian ..... A47G 1/0611            40/793          3,509,290 A    4/1970 Mochida          3,696,885 A *  10/1972 Grieg ..... H04R 1/42            181/141          3,828,508 A *  8/1974 Moeller ..... E04B 9/245            52/506.08          3,857,191 A   12/1974 Sadorus          D237,103 S *  10/1975 Fisher ..... D25/119          3,938,617 A    2/1976 Forbes          3,941,638 A *  3/1976 Horkey ..... H04R 1/02            156/196          4,008,408 A    2/1977 Kodama          4,029,170 A    6/1977 Phillips          4,032,725 A    6/1977 McGee          4,127,156 A *  11/1978 Brandt ..... E06B 9/01            160/179          D255,234 S    6/1980 Wellward          D256,015 S    7/1980 Doherty          4,212,133 A    7/1980 Lufkin          4,244,096 A    1/1981 Kashichi          4,429,850 A *  2/1984 Weber ..... A47F 5/0846            108/108          4,518,826 A    5/1985 Caudill          4,566,557 A    1/1986 Lemaitre          4,866,868 A *  9/1989 Kass ..... G09F 3/201            40/661          4,969,197 A   11/1990 Takaya          5,038,935 A    8/1991 Wenkman          D329,239 S    9/1992 Hahn          D340,718 S   10/1993 Leger</p>	<p>D392,977 S    3/1998 Kim          D394,061 S    5/1998 Fink          5,870,482 A    2/1999 Loeppert          5,888,412 A    3/1999 Sooriakumar          5,888,439 A *  3/1999 Miller ..... H04R 1/023            264/248          6,035,962 A    3/2000 Lin          6,039,457 A *  3/2000 O'Neal ..... F21S 8/00            362/217.16          D424,538 S    5/2000 Hayashi          D432,518 S   10/2000 Muto          6,144,746 A   11/2000 Azima          6,198,831 B1   3/2001 Azima          6,205,224 B1   3/2001 Underbrink          6,266,427 B1   7/2001 Mathur          6,285,770 B1   9/2001 Azima          D453,016 S    1/2002 Nevill          6,393,129 B1   5/2002 Conrad          6,488,367 B1   12/2002 Debesis          D480,923 S *  10/2003 Neubourg ..... D7/554.3          6,665,971 B2 * 12/2003 Lowry ..... G09F 3/20            40/642.02          D489,707 S    5/2004 Kobayashi          D504,889 S    5/2005 Andre          6,944,312 B2 * 9/2005 Mason ..... H04R 1/025            381/189          6,993,145 B2   1/2006 Combest          D526,643 S    8/2006 Ishizaki          D527,372 S    8/2006 Allen          D542,543 S    5/2007 Bruce          D546,318 S    7/2007 Yoon          D547,748 S    7/2007 Tsuge          D549,673 S    8/2007 Niitsu          D552,570 S   10/2007 Niitsu          D559,553 S    1/2008 Mischel          D566,685 S    4/2008 Koller          7,387,151 B1 * 6/2008 Payne ..... E06B 5/006            160/371          D587,709 S    3/2009 Niitsu          D589,605 S    3/2009 Reedy          7,536,769 B2   5/2009 Pedersen          D595,736 S    7/2009 Son          7,565,949 B2   7/2009 Tojo          D613,338 S    4/2010 Marukos          7,701,110 B2   4/2010 Fukuda          D614,871 S    5/2010 Tang          D636,188 S    4/2011 Kim          D642,385 S    8/2011 Lee          8,064,629 B2   11/2011 Jiang          D656,473 S *  3/2012 Laube ..... D14/126          8,213,634 B1   7/2012 Daniel          8,286,749 B2   10/2012 Stewart          8,297,402 B2   10/2012 Stewart          8,403,107 B2   3/2013 Stewart          D685,346 S    7/2013 Szymanski          8,479,871 B2   7/2013 Stewart          8,631,897 B2   1/2014 Stewart          8,670,581 B2   3/2014 Harman          8,672,087 B2   3/2014 Stewart          D717,272 S    11/2014 Kim          D718,731 S *  12/2014 Lee ..... D14/126          D725,059 S *  3/2015 Kim ..... D14/126          D725,631 S    3/2015 McNamara          D726,144 S    4/2015 Kang          D729,767 S    5/2015 Lee</p>

(56)

References Cited

U.S. PATENT DOCUMENTS

D737,245 S 8/2015 Fan  
 9,126,827 B2 9/2015 Hsieh  
 D743,376 S 11/2015 Kim  
 D743,939 S 11/2015 Seong  
 9,226,088 B2 12/2015 Pandey  
 D754,103 S 4/2016 Fischer  
 9,319,799 B2 4/2016 Salmon  
 9,403,670 B2 8/2016 Schelling  
 9,565,493 B2\* 2/2017 Abraham ..... H04R 31/00  
 D784,299 S \* 4/2017 Cho ..... D14/225  
 D864,136 S \* 10/2019 Kim ..... D14/126  
 D865,723 S \* 11/2019 Cho ..... H04R 31/00  
 ..... D14/225  
 D900,070 S \* 10/2020 Lantz ..... D14/229  
 D900,071 S \* 10/2020 Lantz ..... D14/229  
 D900,072 S \* 10/2020 Lantz ..... D14/229  
 D900,073 S \* 10/2020 Lantz ..... D14/229  
 D900,074 S \* 10/2020 Lantz ..... D14/229  
 D924,189 S \* 7/2021 Park ..... D14/126  
 11,109,133 B2\* 8/2021 Lantz ..... H04R 1/406  
 2002/0146282 A1\* 10/2002 Wilkes ..... A47F 5/0068  
 ..... 403/331  
 2002/0149070 A1 10/2002 Sheplak  
 2003/0063762 A1 4/2003 Tajima  
 2005/0286729 A1\* 12/2005 Harwood ..... H04R 7/04  
 ..... 381/152  
 2006/0159293 A1 7/2006 Azima  
 2006/0192976 A1 8/2006 Hall  
 2006/0198541 A1 9/2006 Henry  
 2006/0215866 A1\* 9/2006 Francisco ..... H04R 1/025  
 ..... 381/345  
 2007/0120029 A1 5/2007 Keung  
 2009/0087001 A1 4/2009 Jiang  
 2009/0173030 A1 7/2009 Gulbrandsen  
 2009/0173570 A1 7/2009 Levit  
 2010/0011644 A1 1/2010 Kramer  
 2010/0314513 A1 12/2010 Evans  
 2011/0007921 A1 1/2011 Stewart  
 2011/0311085 A1 12/2011 Stewart  
 2012/0002835 A1 1/2012 Stewart  
 2012/0080260 A1 4/2012 Stewart  
 2012/0177219 A1 7/2012 Mullen  
 2012/0294472 A1 11/2012 Hudson  
 2013/0004013 A1 1/2013 Stewart  
 2013/0015014 A1 1/2013 Stewart

2013/0039504 A1 2/2013 Pandey  
 2013/0094689 A1 4/2013 Tanaka  
 2013/0101141 A1 4/2013 McElveen  
 2013/0251181 A1 9/2013 Stewart  
 2013/0264144 A1 10/2013 Hudson  
 2013/0336516 A1 12/2013 Stewart  
 2014/0072151 A1 3/2014 Ochs  
 2014/0233777 A1 8/2014 Tseng  
 2014/0264654 A1 9/2014 Salmon  
 2014/0265774 A1 9/2014 Stewart  
 2014/0270271 A1 9/2014 Dehe  
 2014/0286518 A1 9/2014 Stewart  
 2014/0301586 A1 10/2014 Stewart  
 2014/0357177 A1 12/2014 Stewart  
 2015/0070188 A1 3/2015 Aramburu  
 2015/0078582 A1 3/2015 Graham  
 2015/0118960 A1 4/2015 Petit  
 2016/0031700 A1 2/2016 Sparks  
 2018/0338205 A1 11/2018 Abraham  
 2020/0288237 A1 9/2020 Abraham

FOREIGN PATENT DOCUMENTS

CN 102833664 A 12/2012  
 CN 104080289 A 10/2014  
 CN 306391029 \* 3/2021  
 EM 007754643-0001 \* 3/2020  
 EP 2721837 A1 4/2014  
 EP 2778310 A1 9/2014  
 WO 2010144148 A2 12/2010  
 WO 2012174159 A1 12/2012

OTHER PUBLICATIONS

Petitioner's Motion for Sanctions, *Clearone, Inc. v. Shure Acquisition Holdings, Inc.*, Aug. 24, 2020, 20 pp.  
 Arnold, et al., "A directional acoustic array using silicon micromachined piezoresistive microphones," *Journal of Acoustical Society of America*, 113 (1), pp. 289-298, Jan. 2003 (10 pp.).  
 Chou, "Frequency-Independent Beamformer with Low Response Error," 1995 International Conference on Acoustics, Speech, and Signal Processing, pp. 2995-2998, May 9, 1995, 4 pp.  
 International Search Report and Written Opinion for PCT/US2016/029751 dated Nov. 28, 2016, 21 pp.  
 Office Action issued for Japanese Patent Application No. 2015-023781 dated Jun. 20, 2016. cited by applicant.

\* cited by examiner

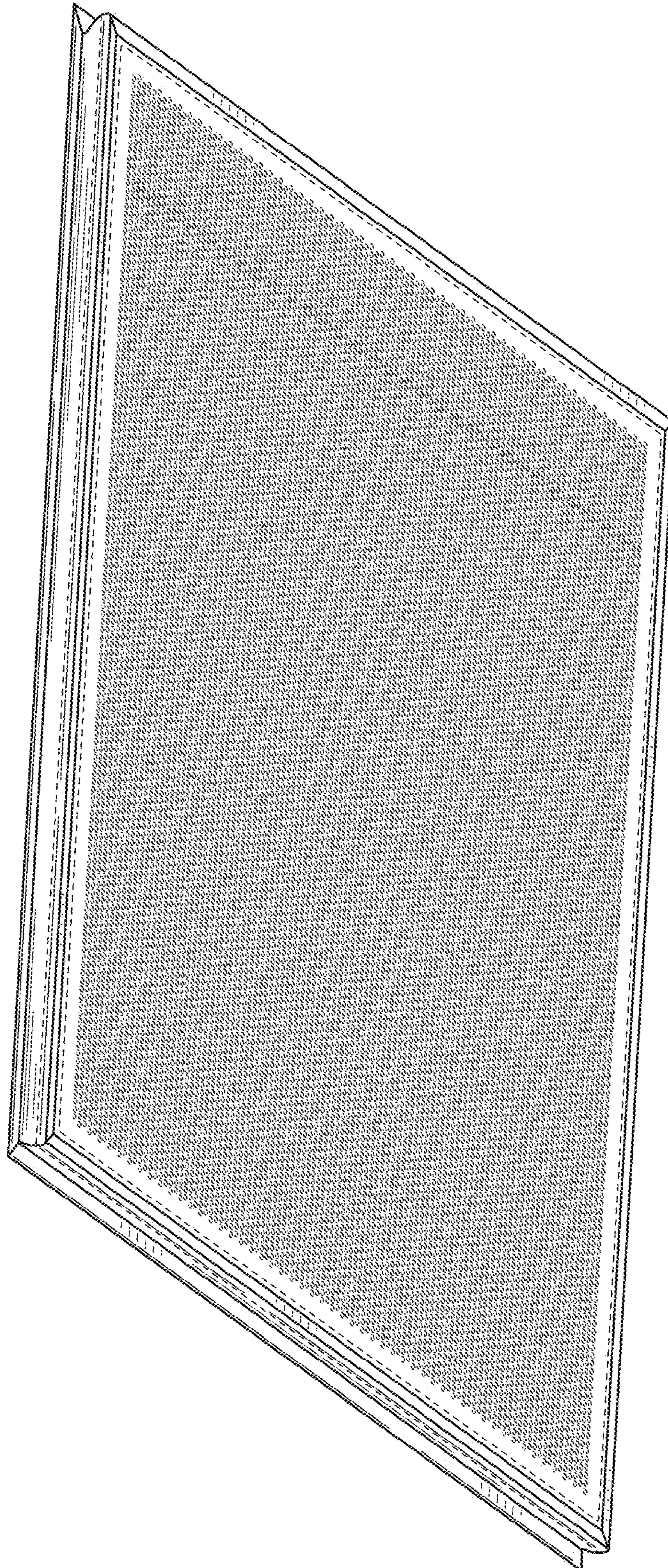

FIG. 1

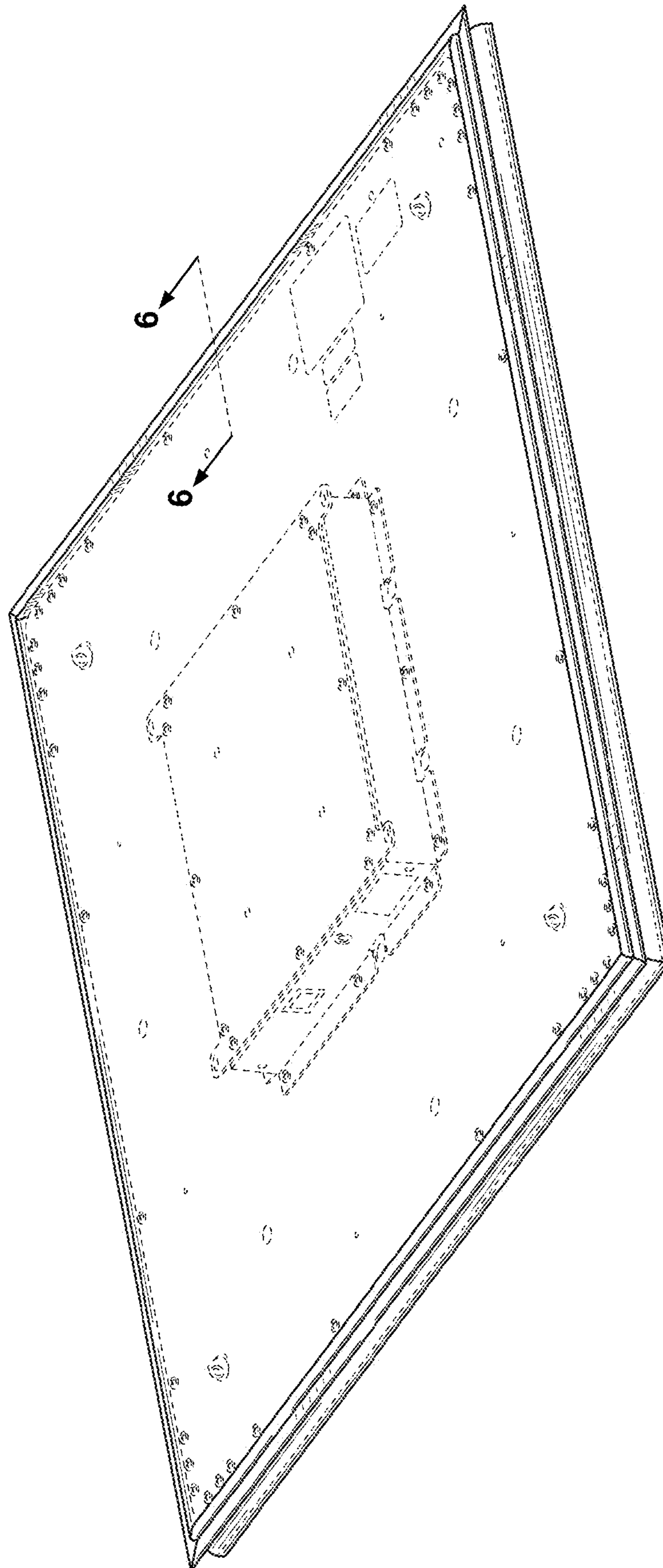

FIG. 2

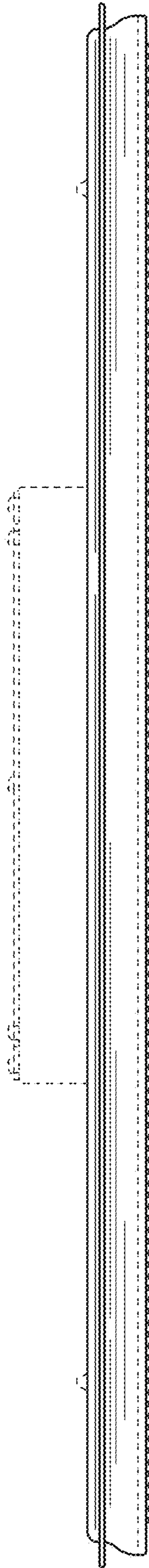

FIG. 3

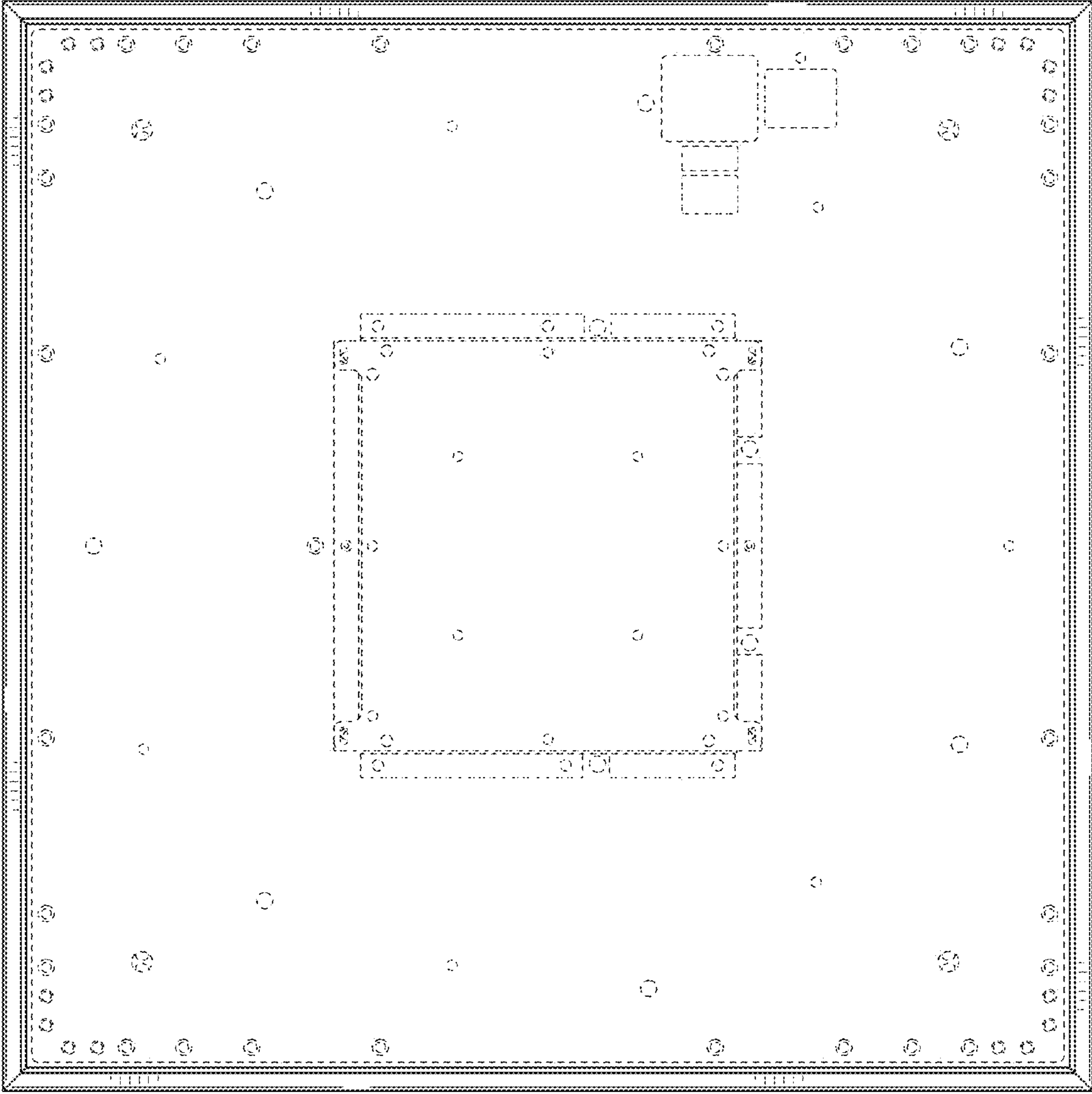

FIG. 4

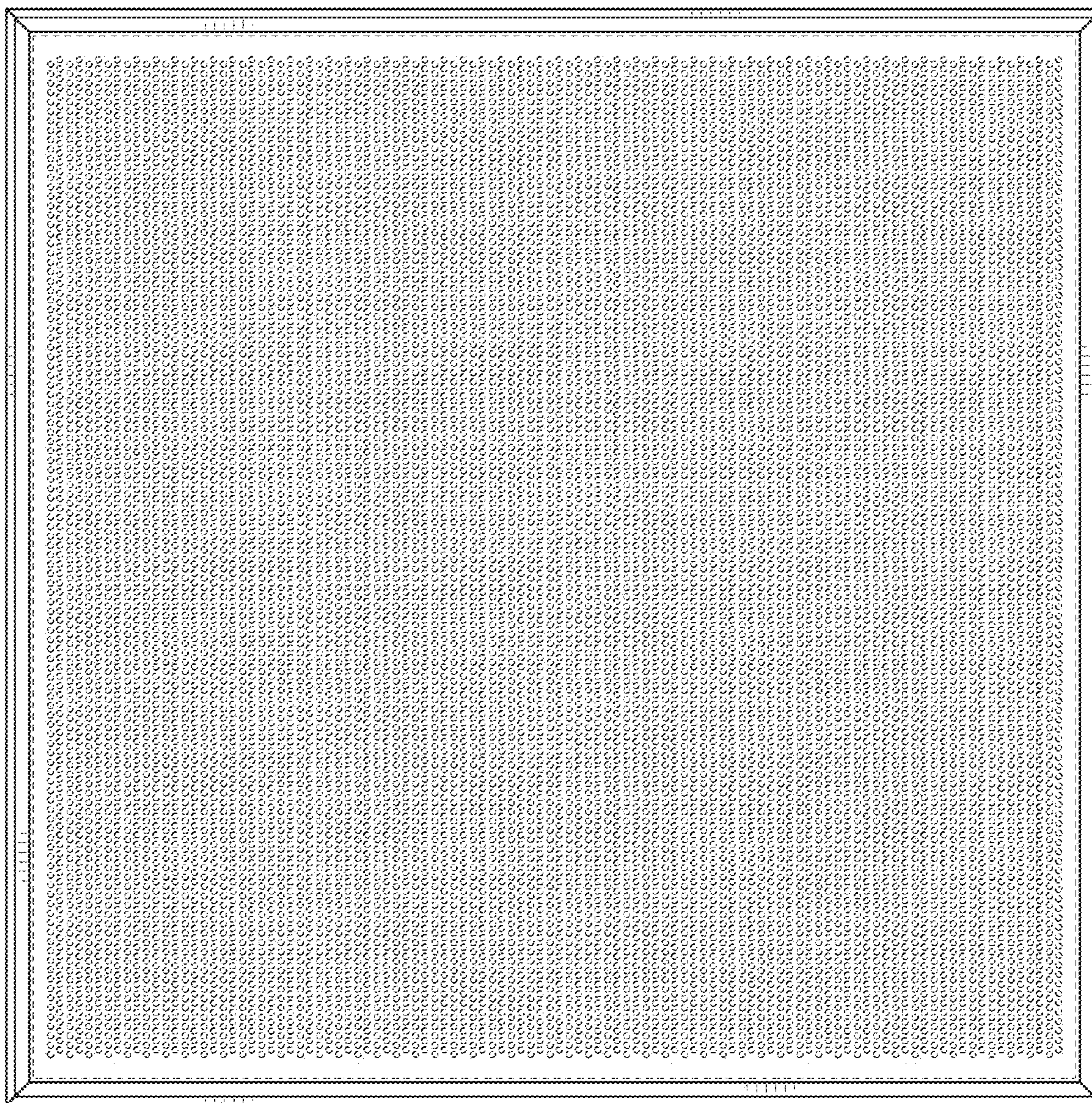

FIG. 5



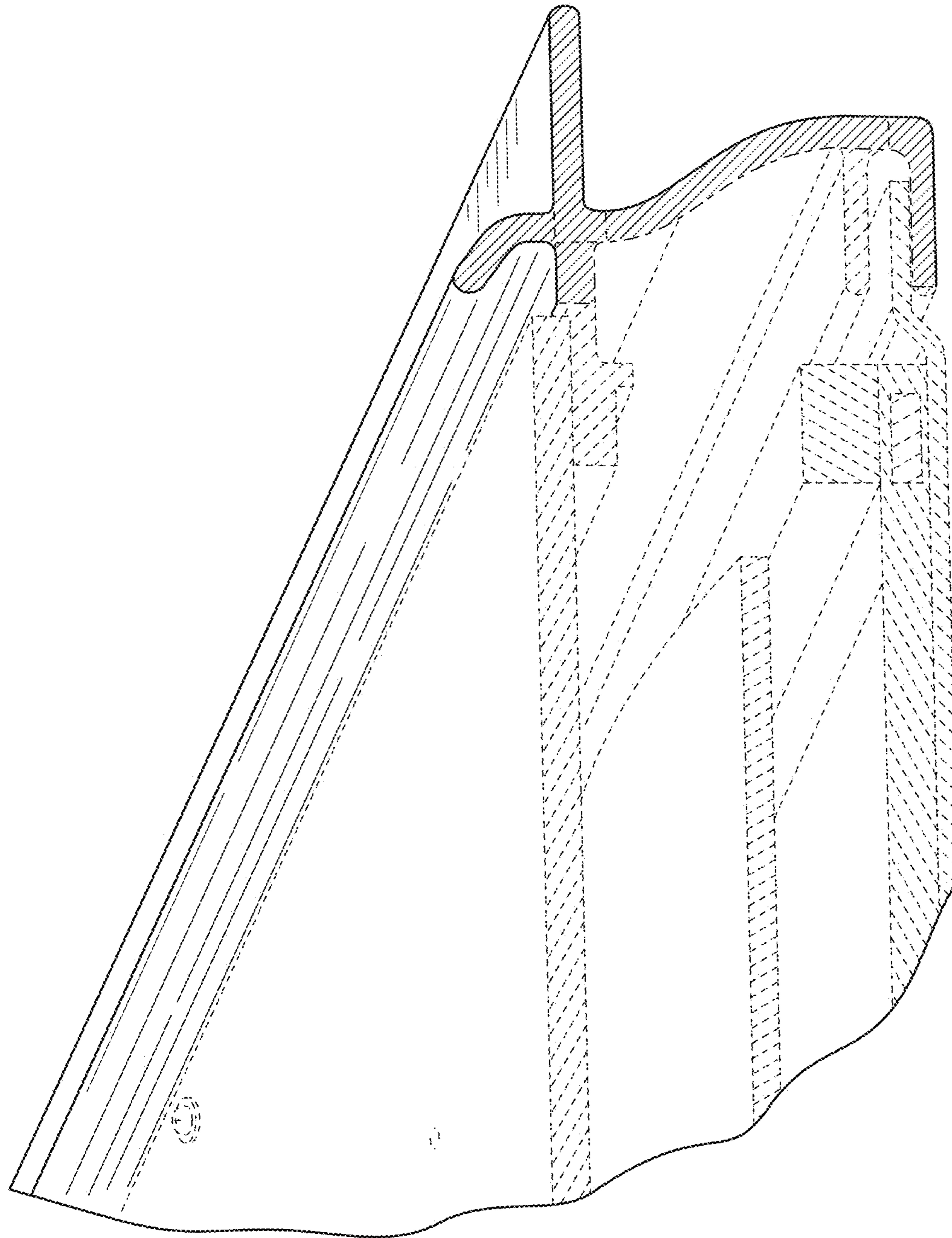

FIG. 6

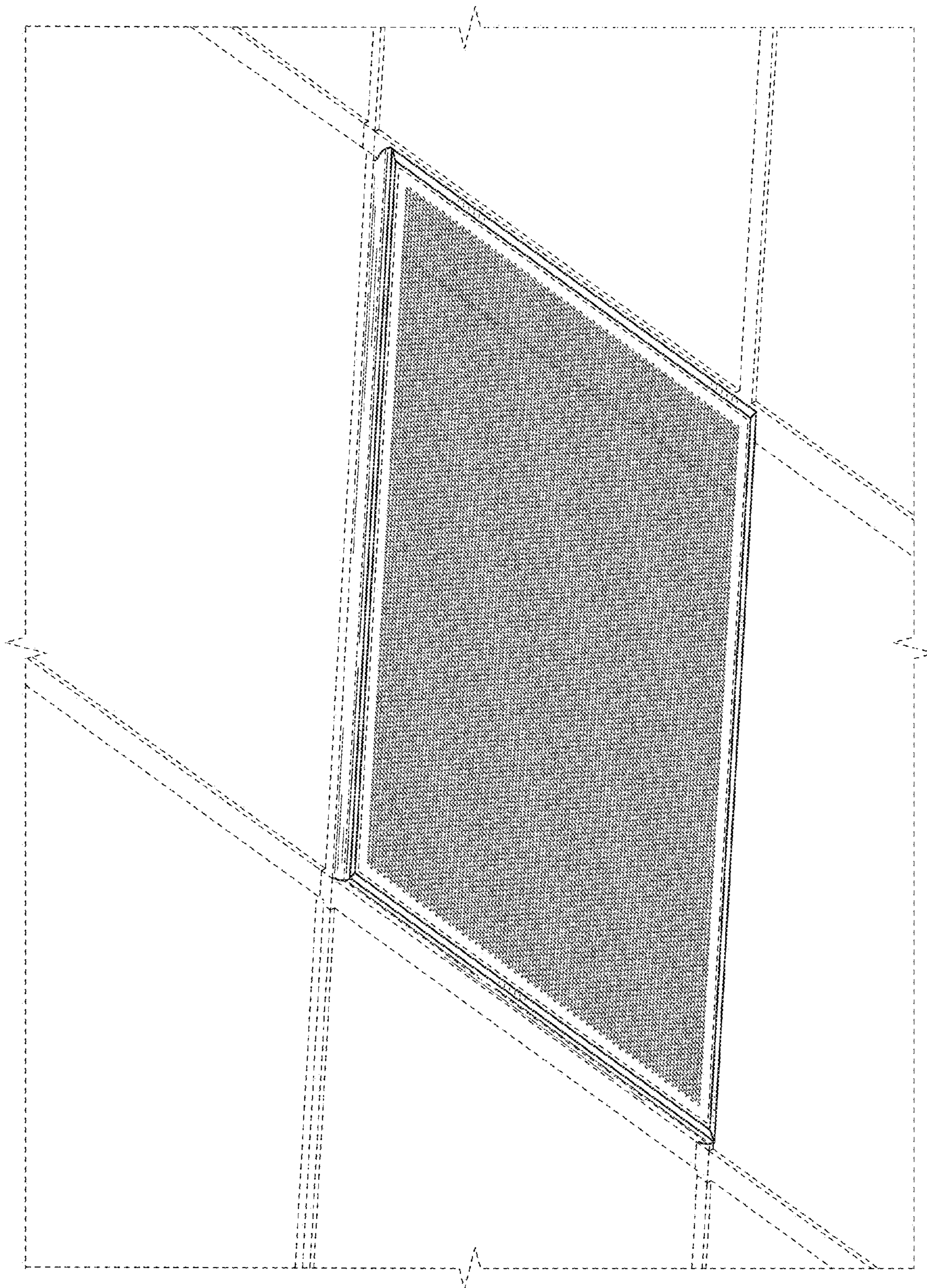

FIG. 7

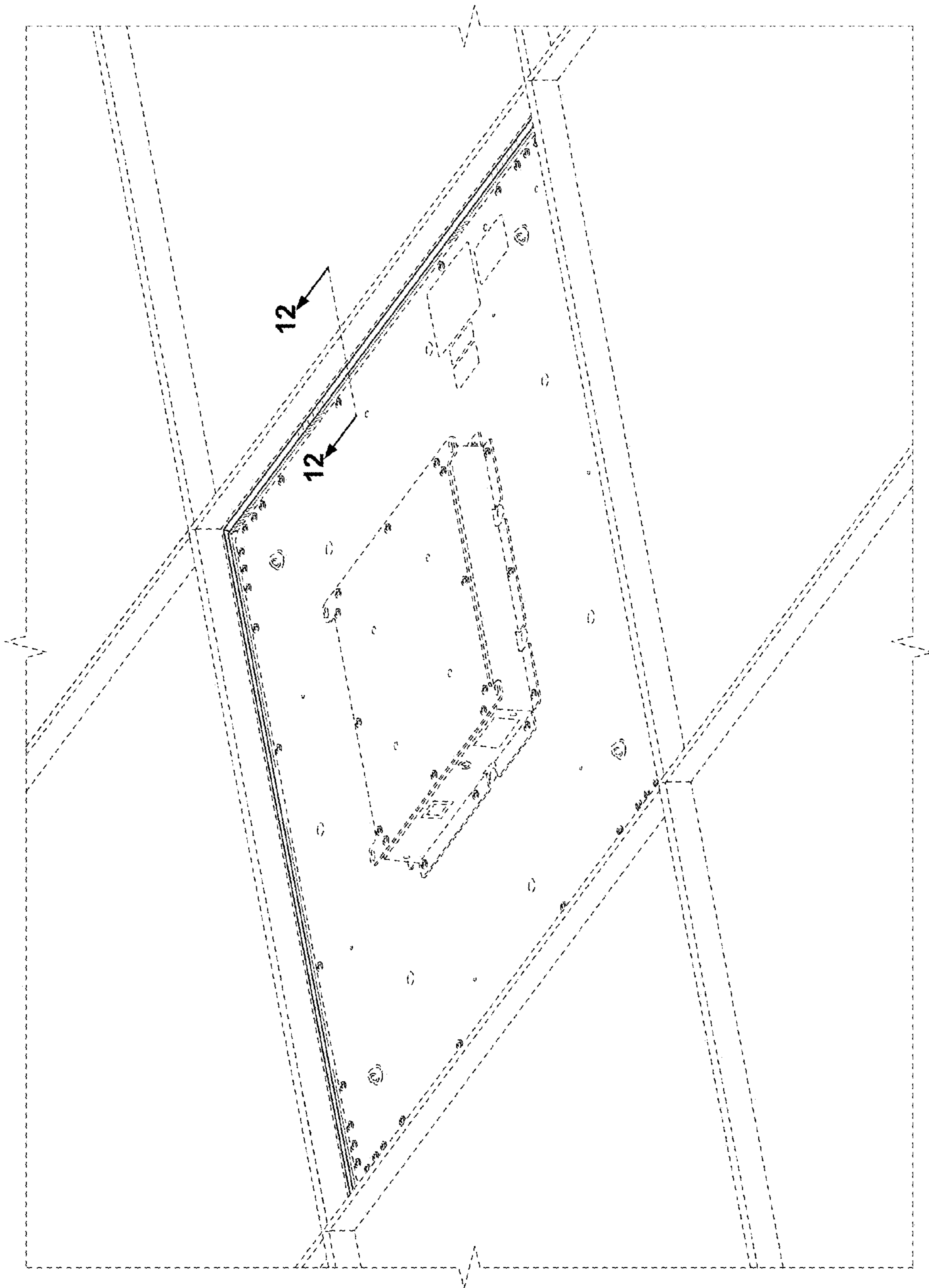

FIG. 8

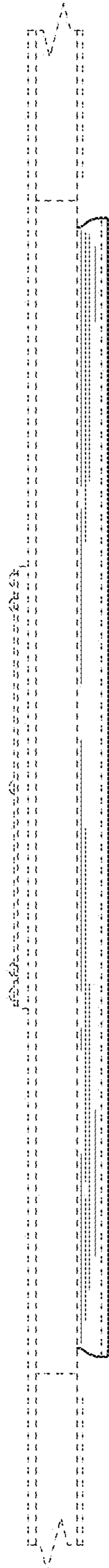

FIG. 9

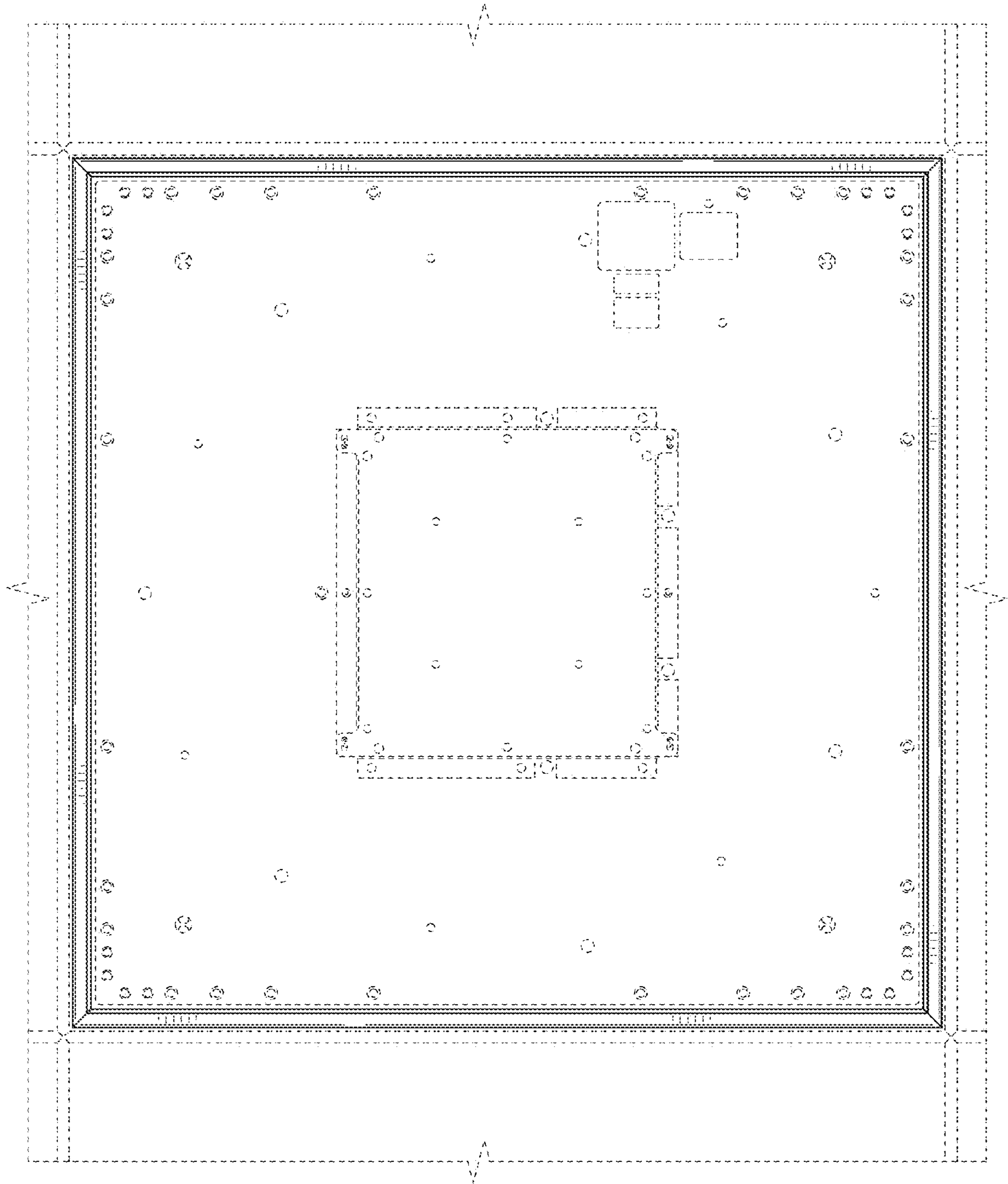

FIG. 10

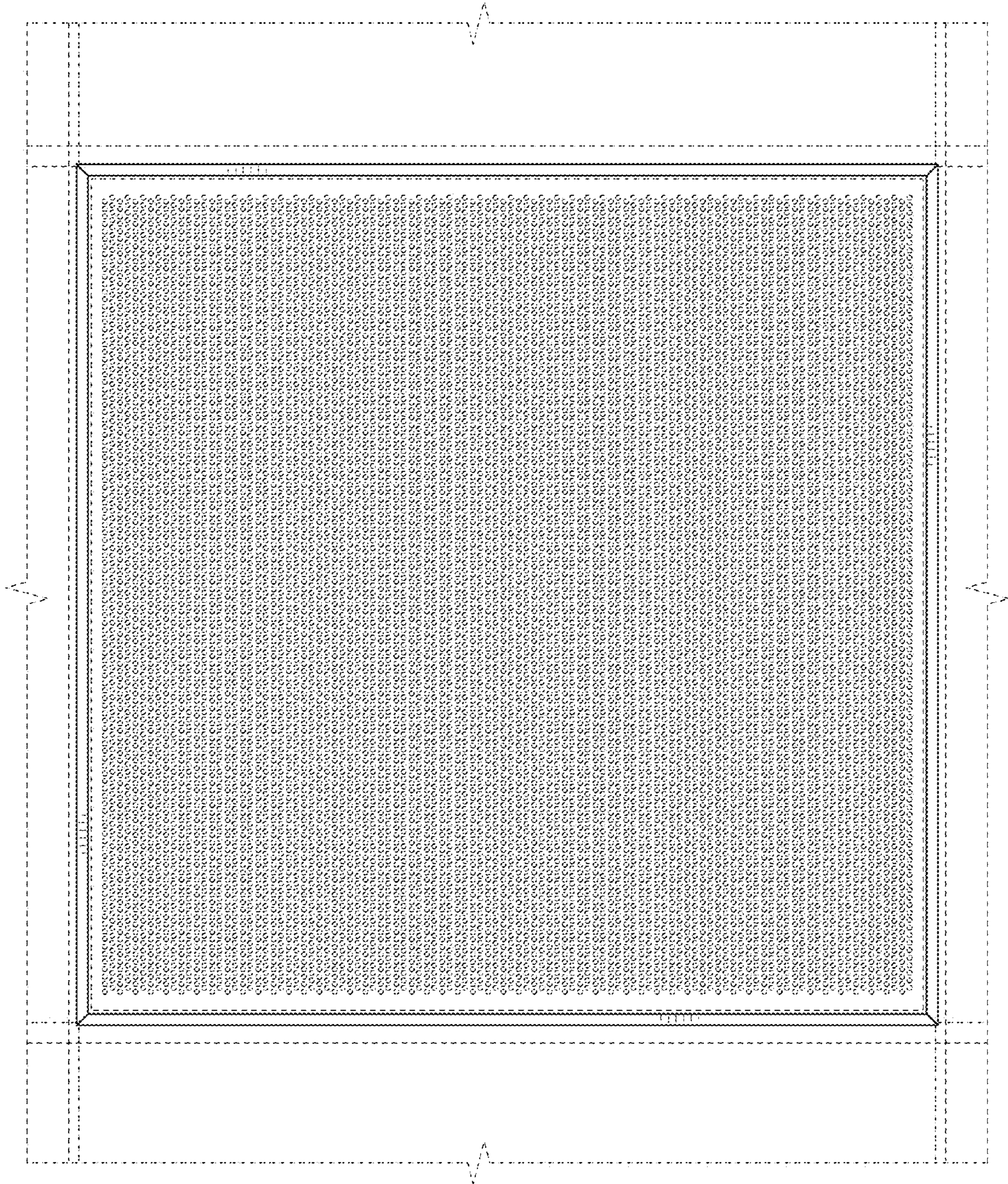

FIG. 11

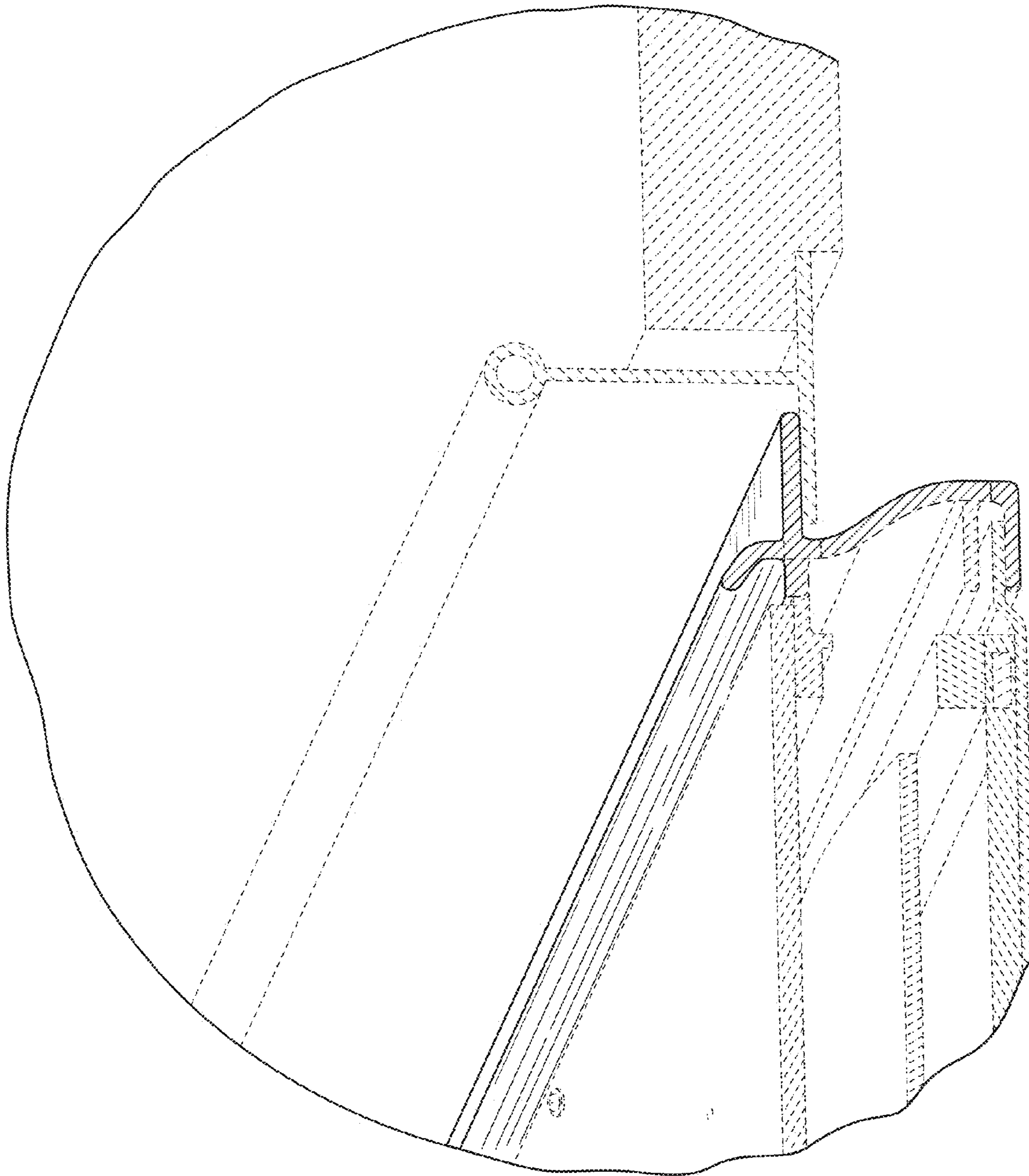

FIG. 12