



US00D943462S

(12) **United States Design Patent** (10) **Patent No.:** **US D943,462 S**
Cattaneo et al. (45) **Date of Patent:** **** Feb. 15, 2022**

(54) **MOTOR SCOOTER**
(71) Applicant: **PIAGGIO & C. S.P.A.**, Pontedera (IT)
(72) Inventors: **Davide Cattaneo**, Pontedera (IT);
Marco Lambri, Pontedera (IT)
(73) Assignee: **PIAGGIO & C. S.P.A.**, Pontedera (IT)
(**) Term: **15 Years**
(21) Appl. No.: **35/510,510**
(22) Filed: **Apr. 3, 2020**

D503,908 S * 4/2005 Tomomatsu D12/110
D610,490 S * 2/2010 Wong D12/110
D622,636 S * 8/2010 Cheng D12/110
D622,637 S * 8/2010 Schneider D12/110
D632,227 S * 2/2011 Lambri D12/110
D642,497 S * 8/2011 Lin D12/110
D643,782 S * 8/2011 Maccioni D12/110
D644,570 S * 9/2011 Chuang D12/110
D647,006 S * 10/2011 Hung D12/110
D654,402 S * 2/2012 Lambri D12/110
D664,898 S * 8/2012 Van Hooydonk D12/110
D669,395 S * 10/2012 Lambri D12/110
D669,396 S * 10/2012 Sawatsutipan D12/110
D673,882 S * 1/2013 Tartarini D12/110
D678,128 S * 3/2013 Lambri D12/110
D678,129 S * 3/2013 Kubota D12/110

(Continued)

(80) **Hague Agreement Data**

Int. Filing Date: **Apr. 3, 2020**
Int. Reg. No.: **DM/207487**
Int. Reg. Date: **Apr. 3, 2020**
Int. Reg. Pub. Date: **Oct. 9, 2020**

(30) **Foreign Application Priority Data**

Oct. 18, 2019 (EM) 007059126

(51) **LOC (13) Cl.** **12-11**

(52) **U.S. Cl.**
USPC **D12/110**

(58) **Field of Classification Search**
USPC D12/110, 111, 117; D21/432, 538
CPC B62K 11/00; B62K 11/02; B62K 11/04;
B62K 11/10; B62K 17/00; B62K 19/00;
B62K 2202/00

See application file for complete search history.

(56) **References Cited**

U.S. PATENT DOCUMENTS

4,487,283 A * 12/1984 Suzuki B62J 17/00
180/219
4,715,465 A * 12/1987 Takahashi B62J 17/00
180/219
D475,950 S * 6/2003 Kawano D12/110
D490,750 S * 6/2004 Hoshino D12/110

OTHER PUBLICATIONS

Janaki Jitchotvisut. "Piaggio Beverly Scooters Get Euro 5 And Styling Update." RideApart., Dec. 28, 2020 [online], [retrieved on Dec. 6, 2021]. Retrieved from the Internet <URL: <https://www.rideapart.com/news/462647/piaggio-beverly-scooters-euro-5-update/>>.*

(Continued)

Primary Examiner — Darlington Ly
(74) *Attorney, Agent, or Firm* — Cantor Colburn LLP

(57) **CLAIM**

The ornamental design for a motor scooter, as shown and described.

DESCRIPTION

2.1 is a front and right side perspective view of a motor scooter embodying our new design;
2.2 : is a front elevation view thereof;
2.3 : is a rear elevation view thereof;
2.4 : is a left side elevation view thereof;
2.5 : is a right side elevation view thereof;
2.6 : is a top plan view thereof; and
2.7 : is a front and left side perspective view thereof.

1 Claim, 7 Drawing Sheets

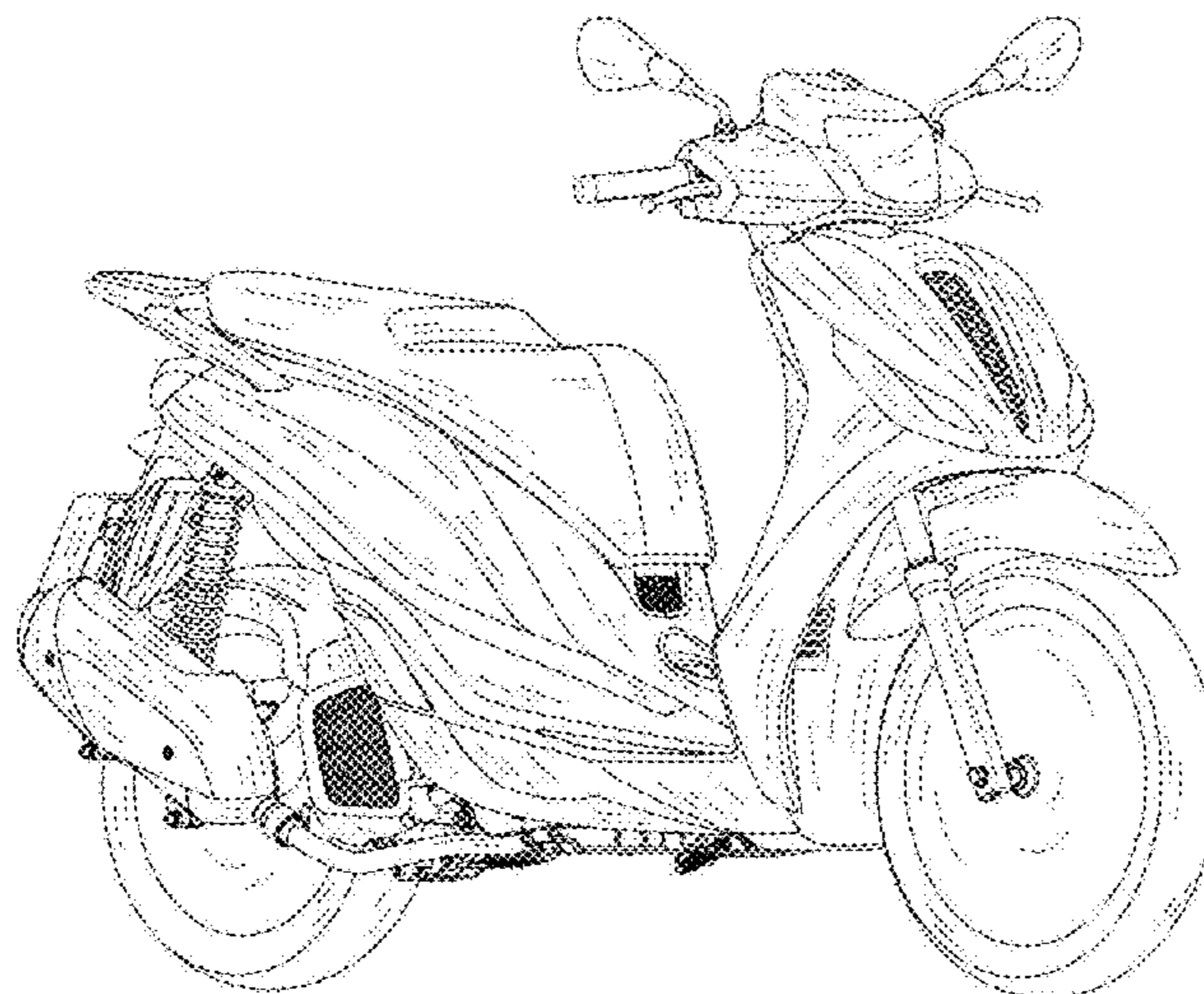

(56)

References Cited

U.S. PATENT DOCUMENTS

D680,911 S * 4/2013 Wu D12/110
D697,835 S * 1/2014 Kito D12/110
D726,076 S * 4/2015 Arai D12/110
D727,799 S * 4/2015 Castrucci D12/110
9,216,787 B2 * 12/2015 Duncan B62K 19/46

OTHER PUBLICATIONS

Don Williams. "2021 Piaggio Beverly Scooter Lineup First Look (10 Fast Facts)." Ultimate Motorcycling., Dec. 26, 2020 [online], [retrieved on Dec. 6, 2021]. Retrieved from the Internet <URL: <https://ultimatemotorcycling.com/2020/12/26/2021-piaggio-beverly-scooter-lineup-first-look-10-fast-facts/>>.*

"Motorcycles / Scooters—2018." Honda., Jan. 3, 2018 [online], [retrieved on Dec. 6, 2021]. Retrieved from the Internet <URL: <https://powersports.honda.com/-/media/products/family/nm4/brochures/2018/2018-nm4-brochure.pdf>>.*

* cited by examiner

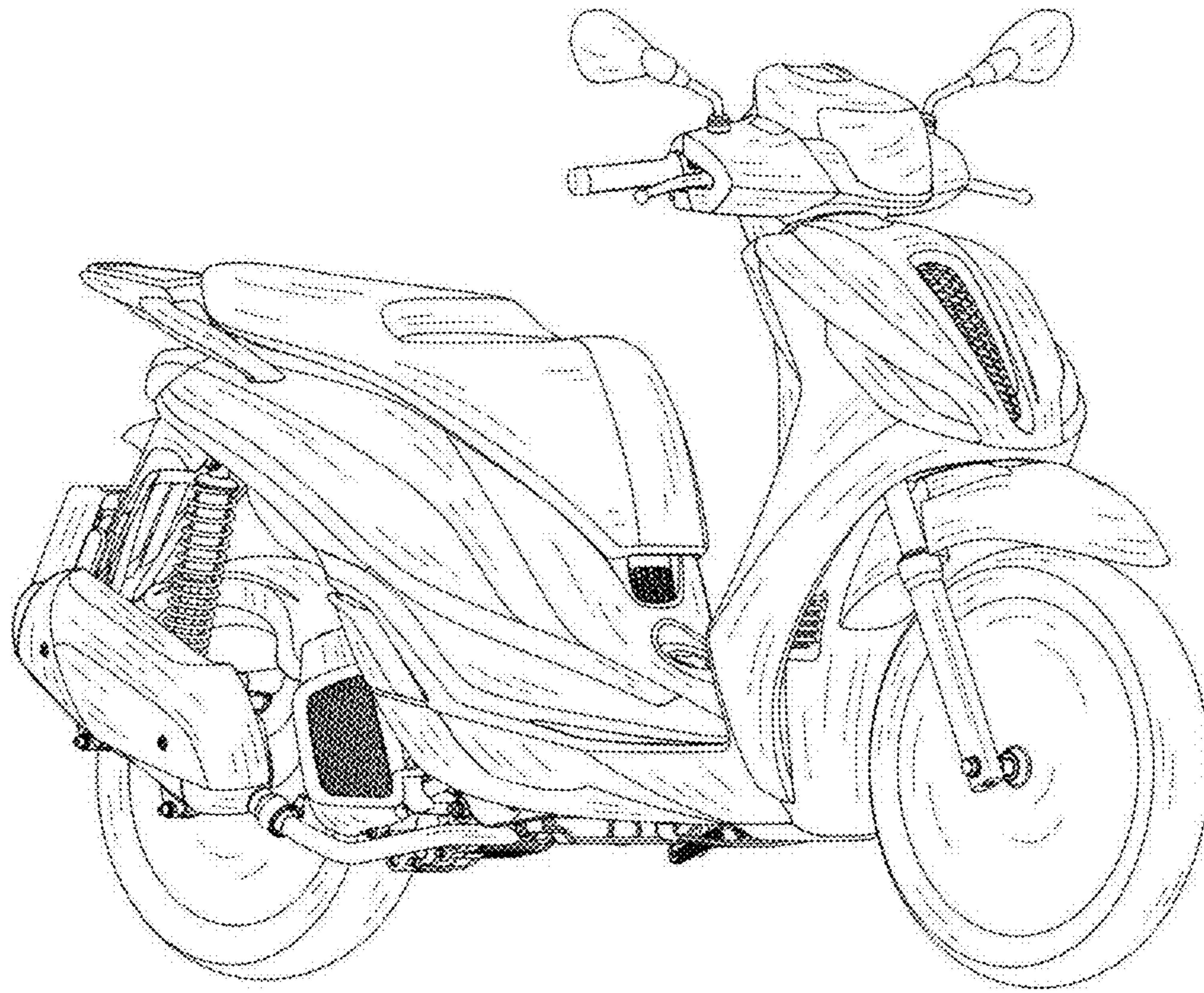

2.1

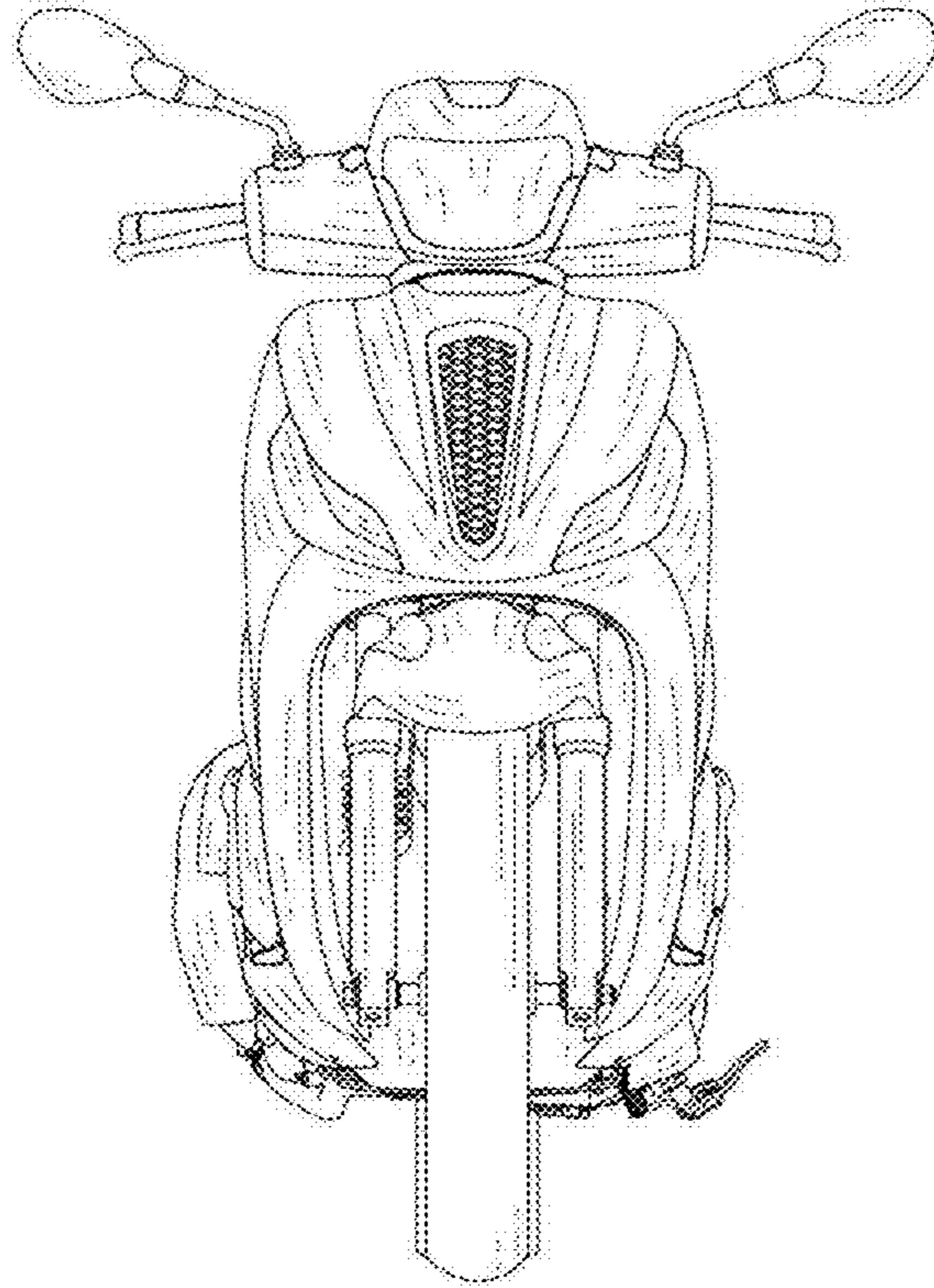

2.2

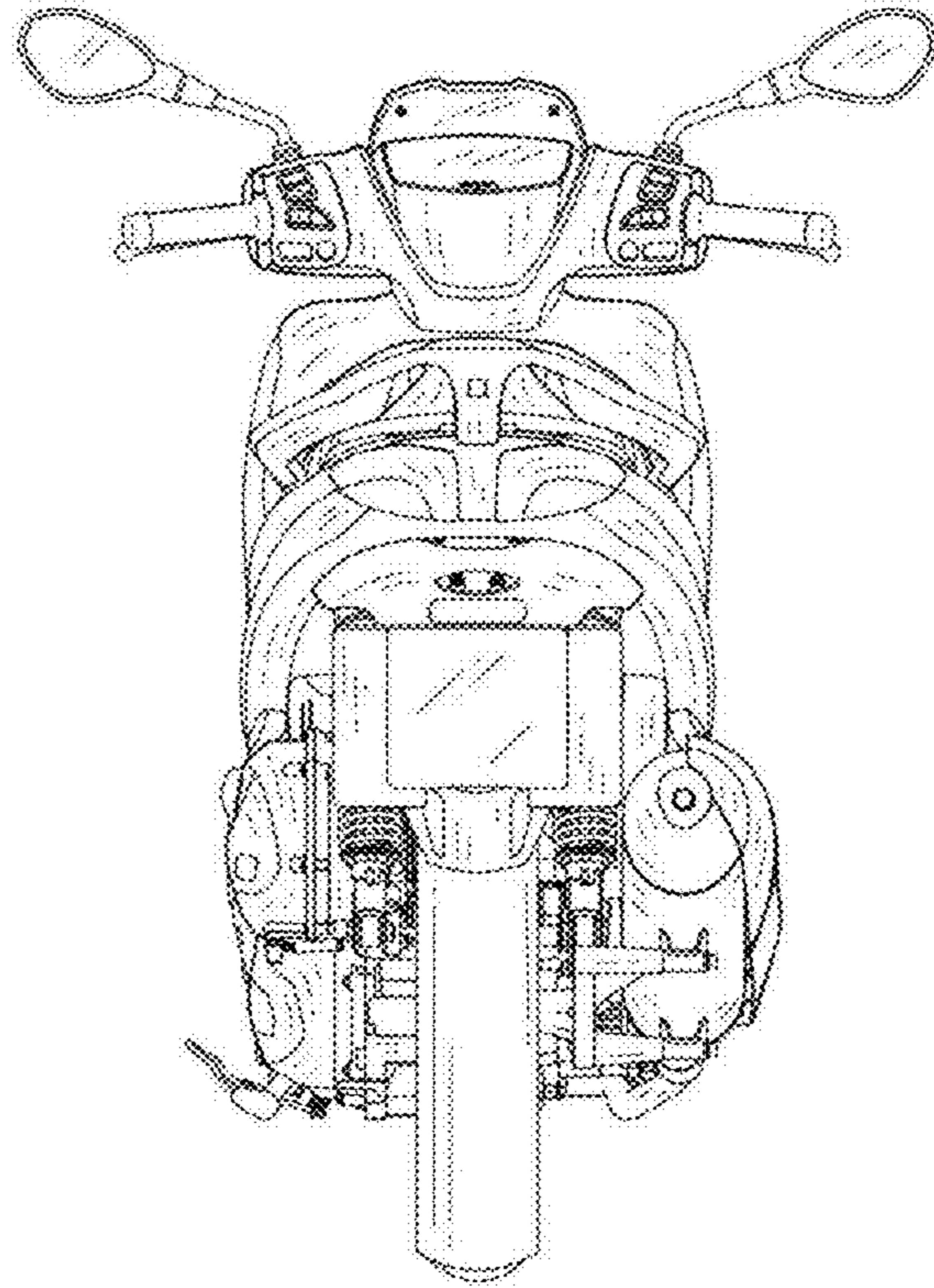

2.3

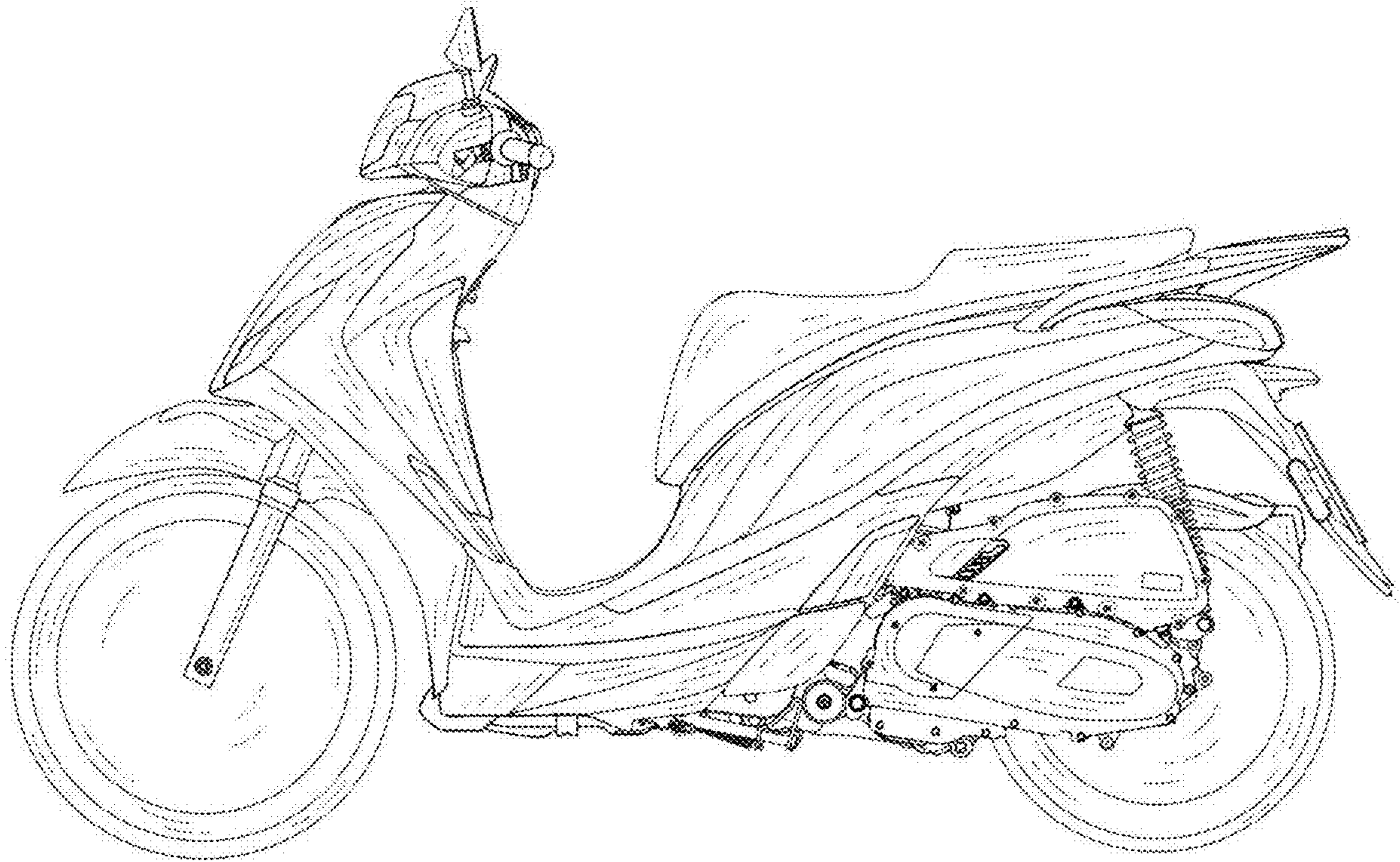

2.4

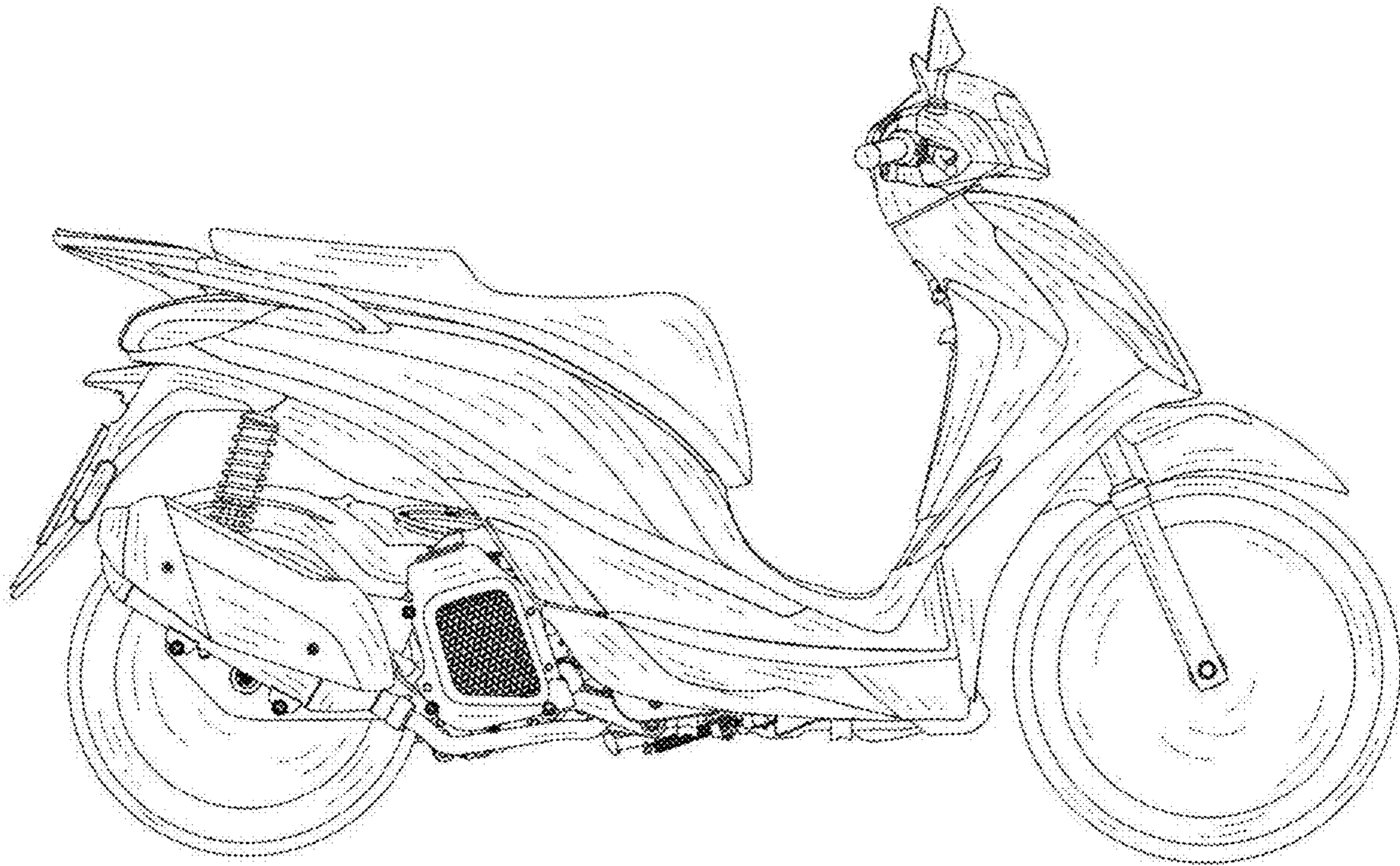

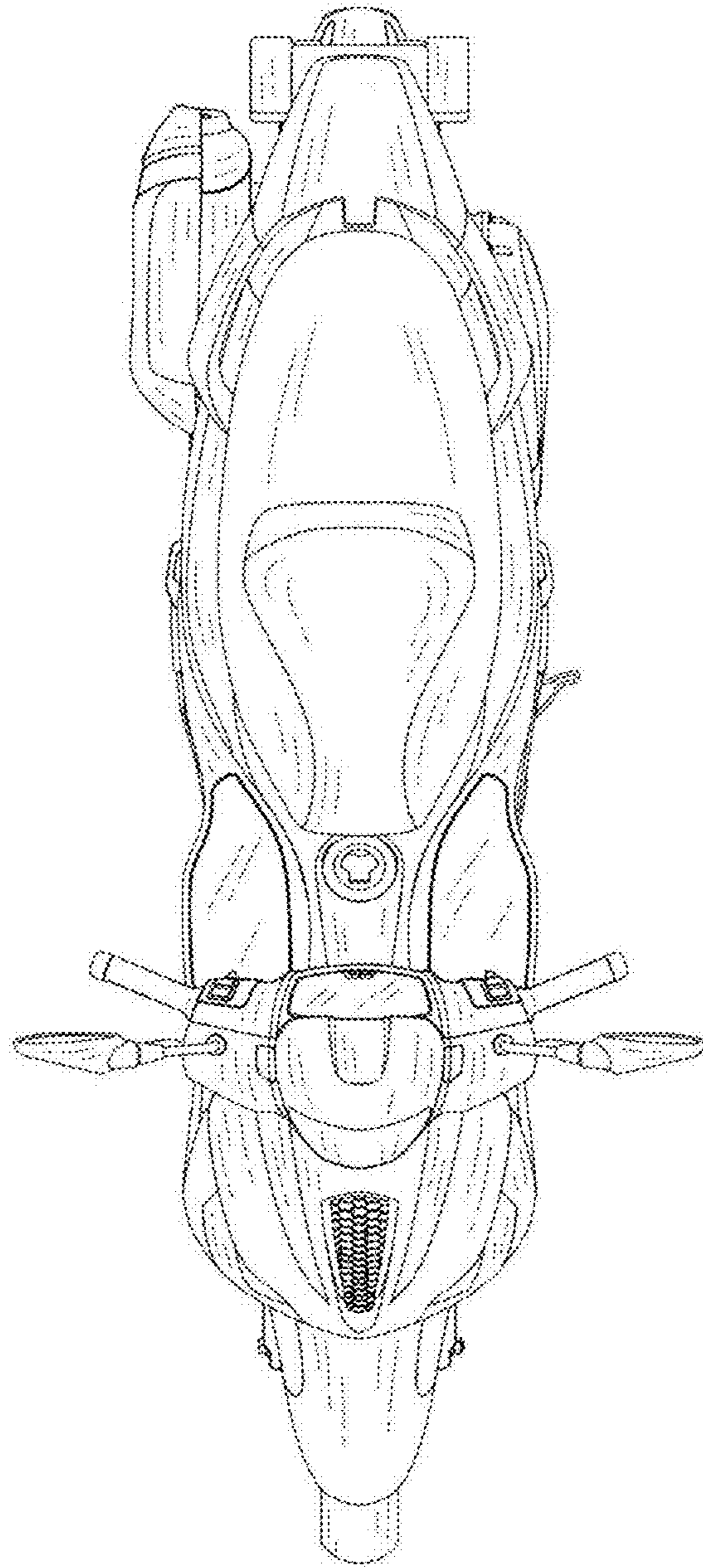

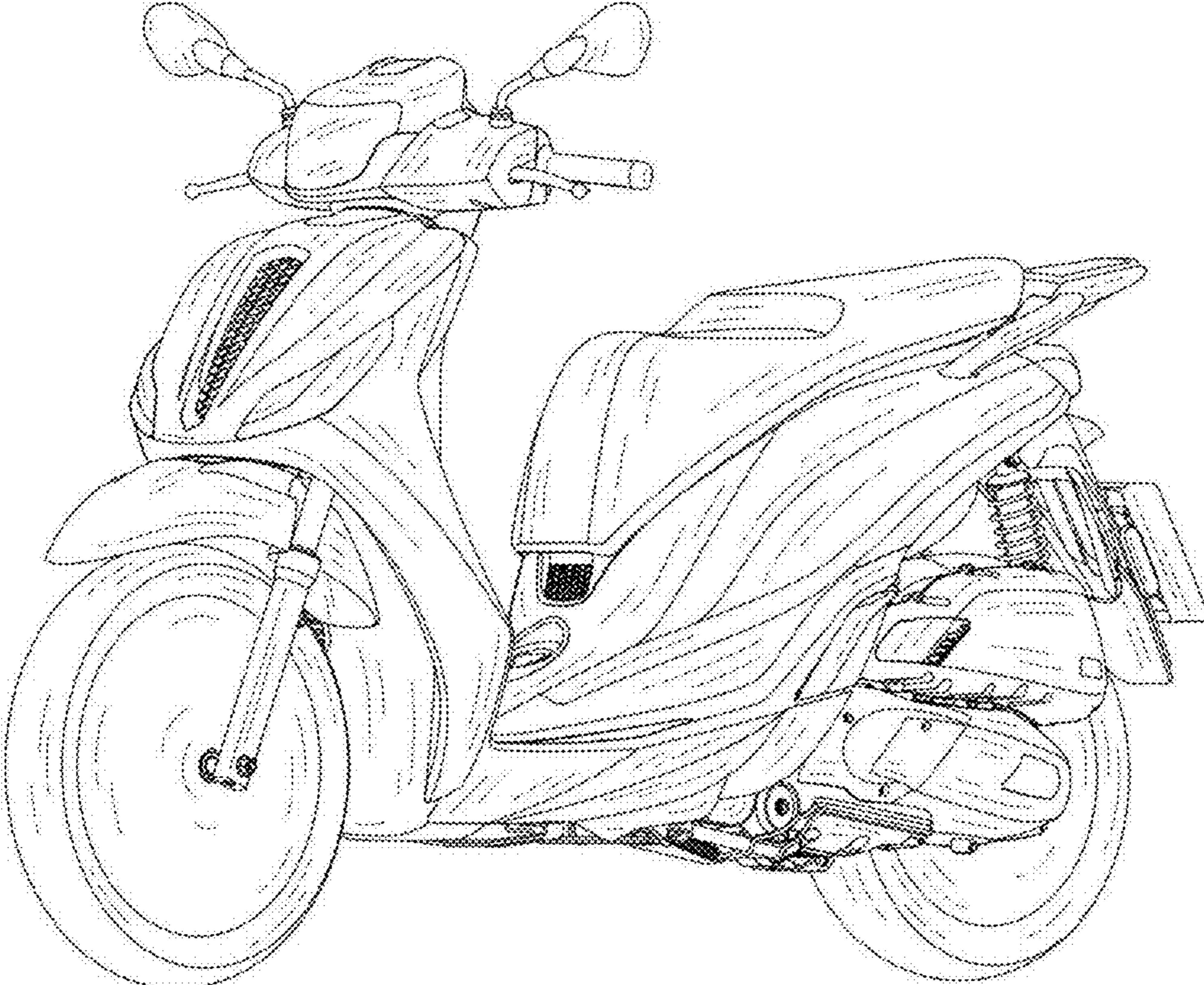

2.7