



US00D943380S

(12) **United States Design Patent** (10) **Patent No.:** **US D943,380 S**  
**Hu** (45) **Date of Patent:** **\*\* Feb. 15, 2022**

(54) **CABLE FASTENER CLAMP**  
(71) Applicant: **Chaolan Hu**, Nanchang (CN)  
(72) Inventor: **Chaolan Hu**, Nanchang (CN)  
(\*\*) Term: **15 Years**  
(21) Appl. No.: **29/770,002**  
(22) Filed: **Feb. 9, 2021**  
(51) **LOC (13) Cl.** ..... **08-05**  
(52) **U.S. Cl.**  
USPC ..... **D8/72**  
(58) **Field of Classification Search**  
USPC ..... D8/71-74, 394-399, 59; 248/63, 72,  
248/74.1, 689, 124.2; 81/487, 385, 386,  
81/388-390; 269/3, 4, 6, 143, 165, 240,  
269/243, 246-249, 254 R, 147-149;  
29/256, 257, 276; 408/103, 104-109  
CPC ..... B25B 1/00; B25B 5/00  
See application file for complete search history.

D823,103 S \* 7/2018 Glasscock ..... D8/395  
D836,072 S 12/2018 Gray  
D850,247 S \* 6/2019 Sillitoe ..... D8/394  
D871,191 S 12/2019 Mogensen  
D876,212 S \* 2/2020 Waldman ..... A61H 7/001  
D877,604 S \* 3/2020 Sillitoe ..... D8/394  
D889,254 S \* 7/2020 Copete Vilella ..... D8/394  
D891,241 S \* 7/2020 Buczynski ..... D8/395  
D892,607 S \* 8/2020 Boscarello ..... D8/394  
D911,158 S \* 2/2021 Jenkins ..... D8/394  
D933,467 S \* 10/2021 Von Fange ..... D8/396  
D934,515 S \* 10/2021 Wendling ..... D30/199

\* cited by examiner

*Primary Examiner* — David G Muller

(57) **CLAIM**

The ornamental design for a cable fastener clamp, as shown and described.

**DESCRIPTION**

FIG. 1 is a perspective view of a cable fastener clamp showing my new design;  
FIG. 2 is a front elevation view thereof;  
FIG. 3 is a rear elevation view thereof;  
FIG. 4 is a left side elevation view thereof;  
FIG. 5 is a right side elevation view thereof;  
FIG. 6 is a top plan view thereof; and,  
FIG. 7 is a bottom plan view thereof.  
The broken lines depict portions of the cable fastener clamp which form no part of the claimed design.

(56) **References Cited**

U.S. PATENT DOCUMENTS

D484,400 S 12/2003 Blake  
D507,481 S 7/2005 Blake  
D675,509 S \* 2/2013 Gary ..... D8/395  
D706,225 S 6/2014 deLoache  
D709,359 S 7/2014 Symons  
D717,159 S 11/2014 Lindberg  
D722,490 S \* 2/2015 Lyons ..... D8/395  
D741,699 S \* 10/2015 Barker ..... D8/395  
D789,779 S \* 6/2017 Asai ..... B60R 16/0215  
D8/396  
D794,438 S \* 8/2017 Davis ..... D8/395

**1 Claim, 7 Drawing Sheets**

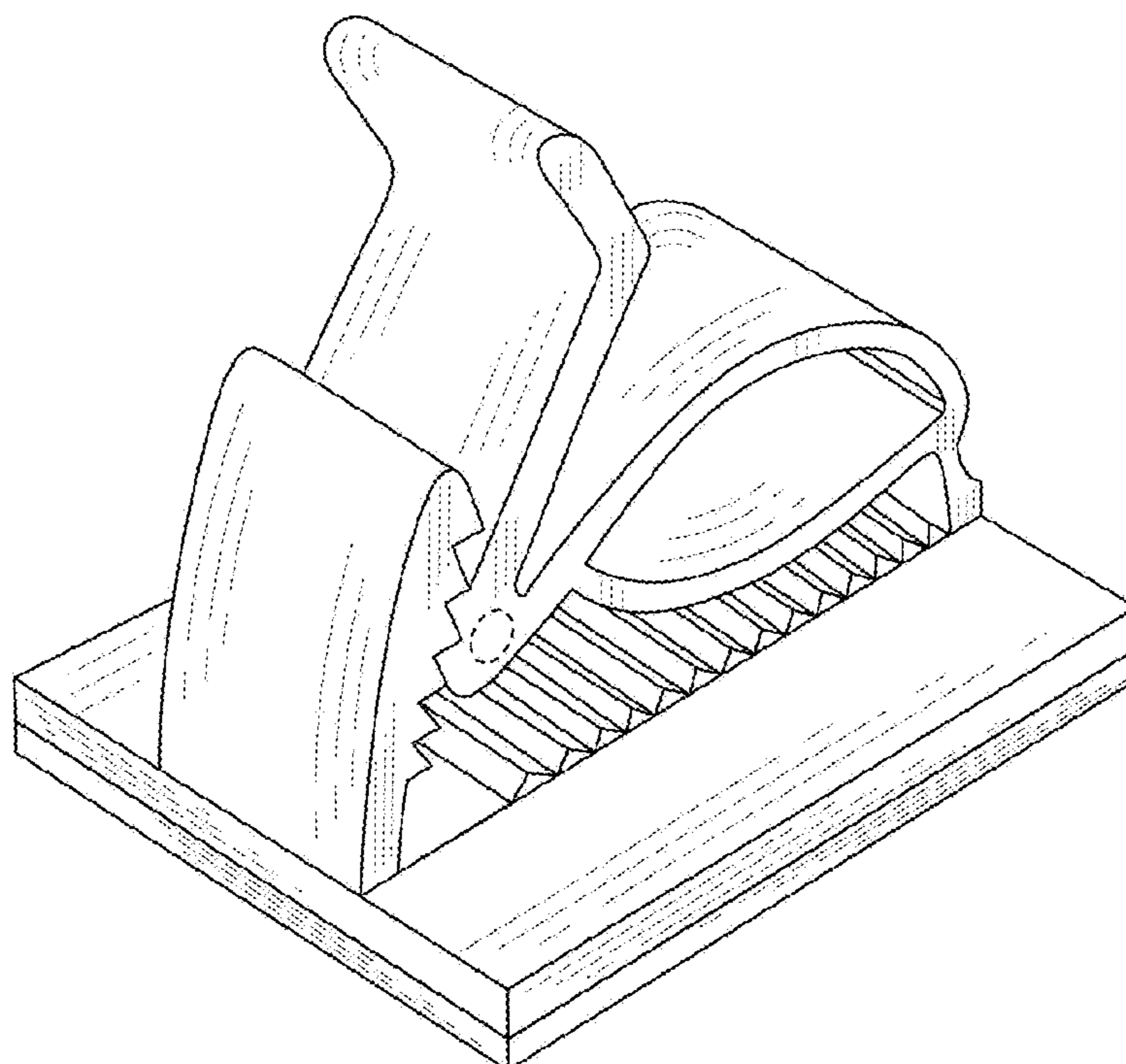

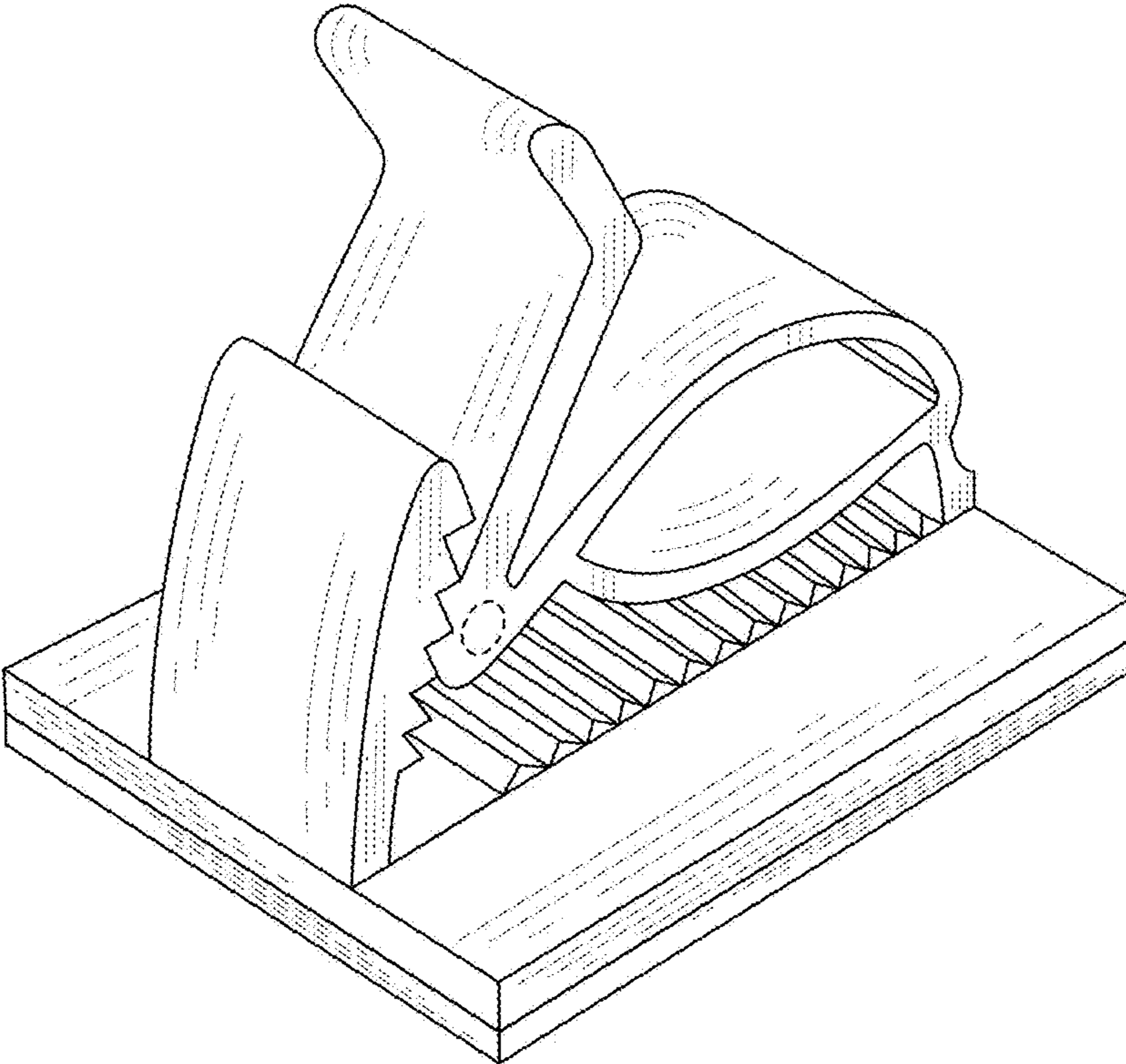

FIG.1

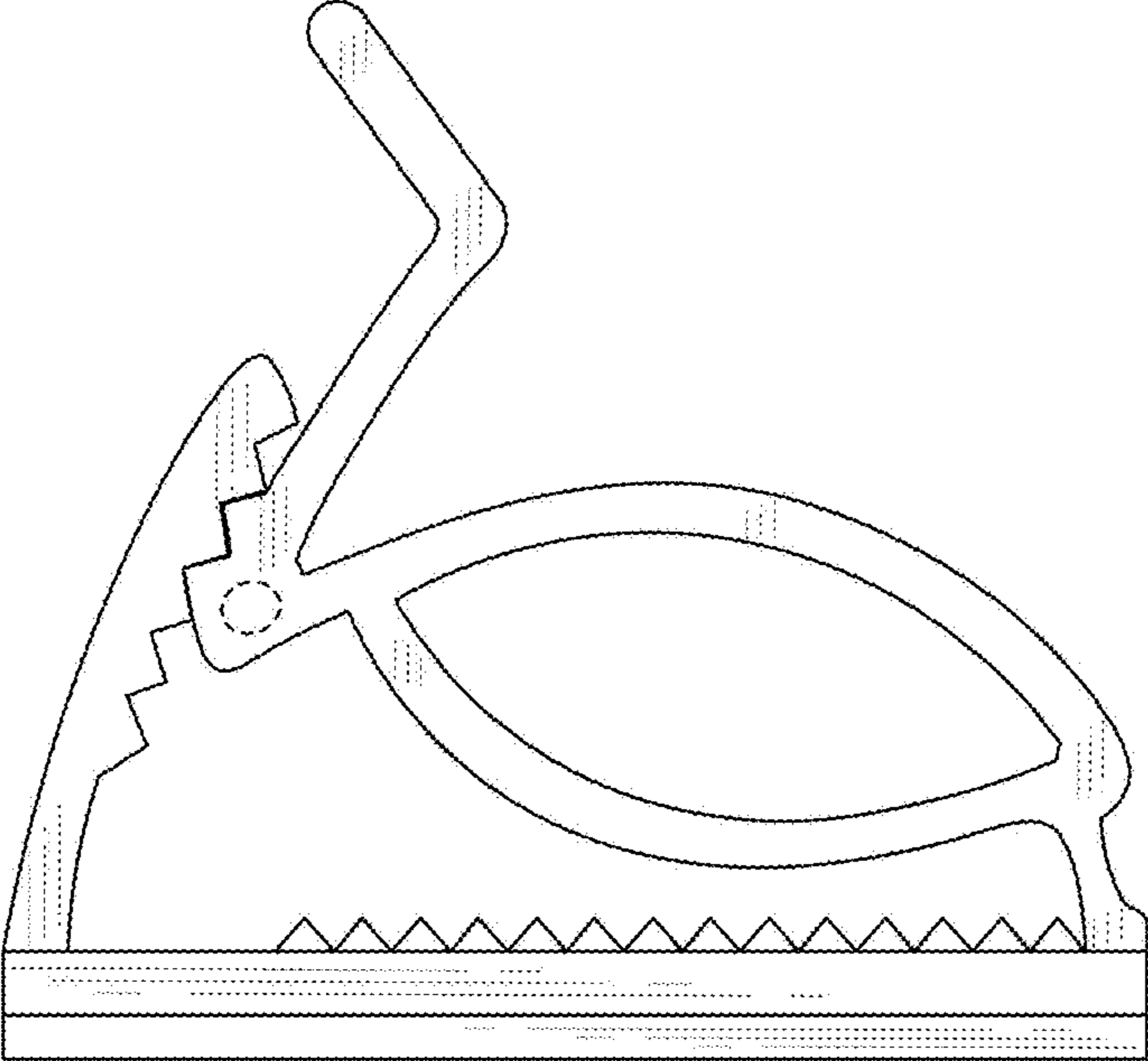

FIG.2

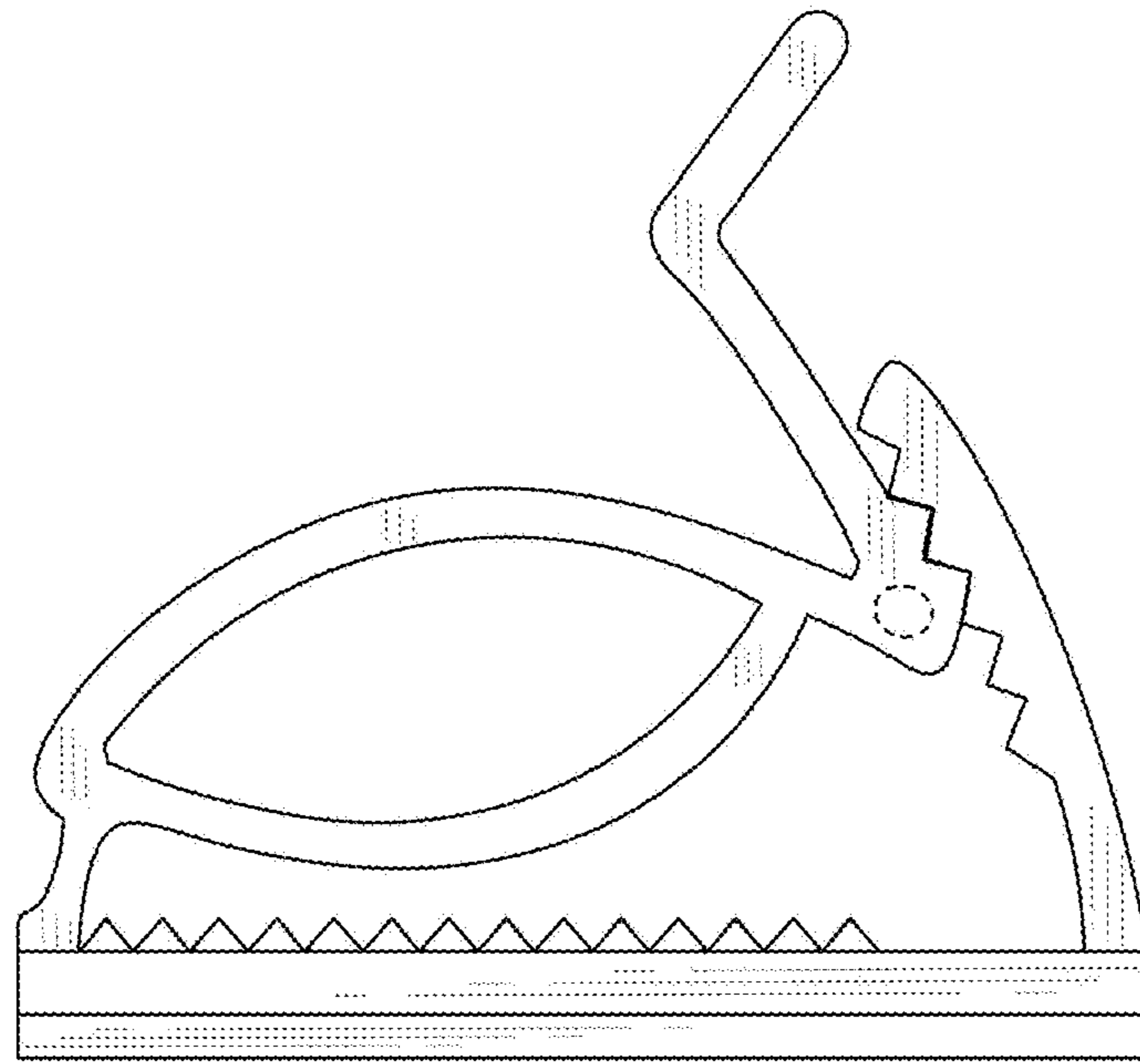

FIG.3

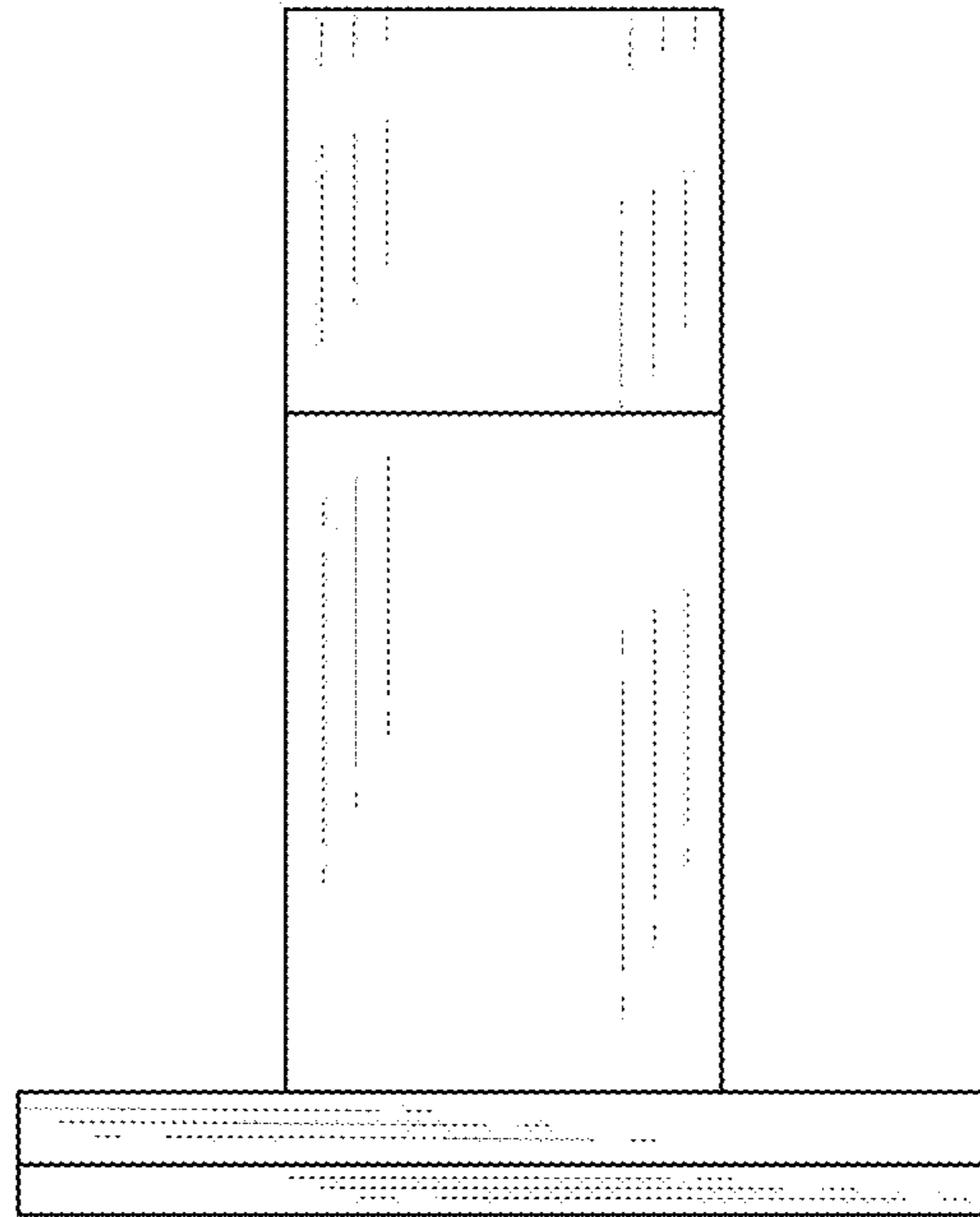

FIG. 4

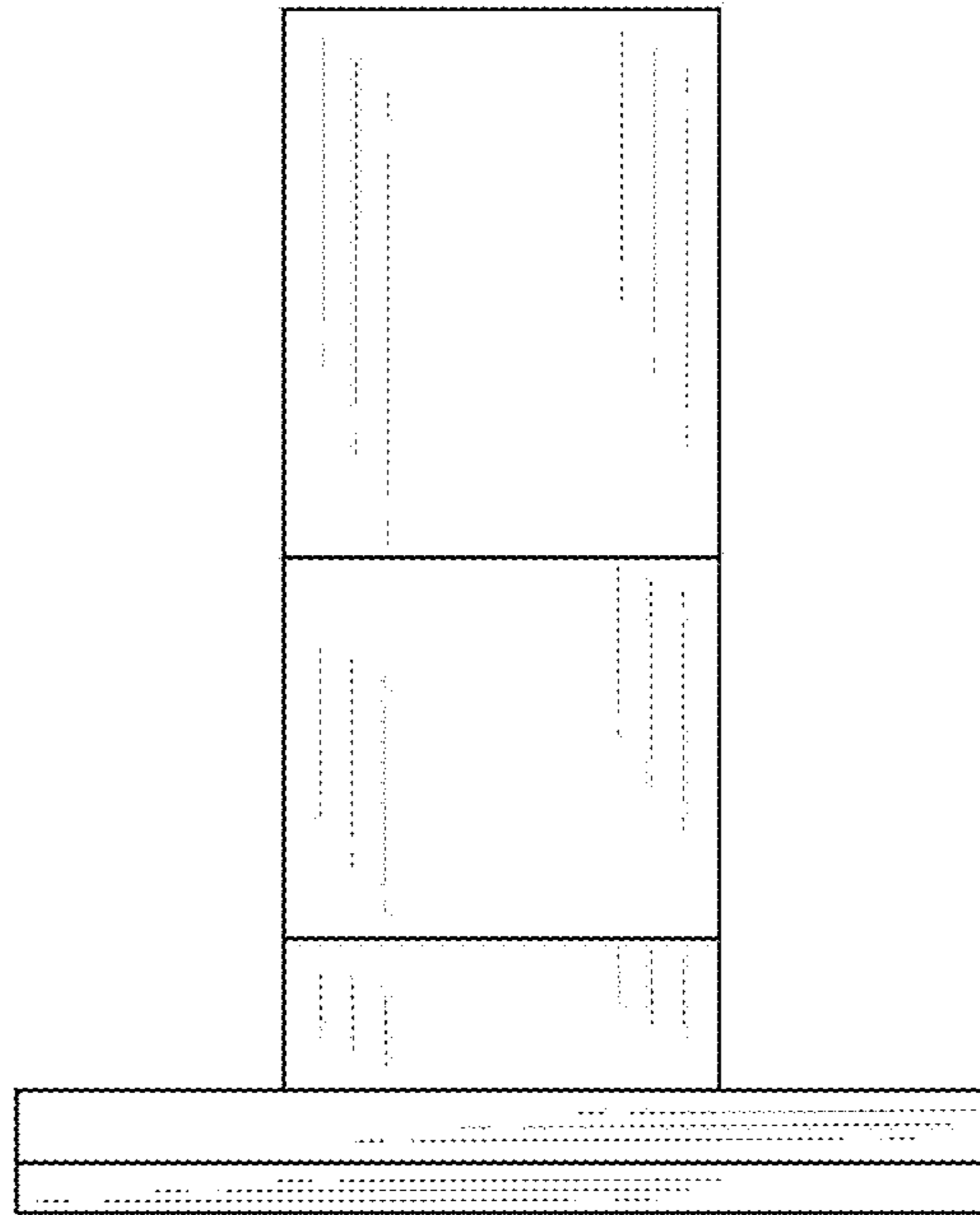

FIG.5

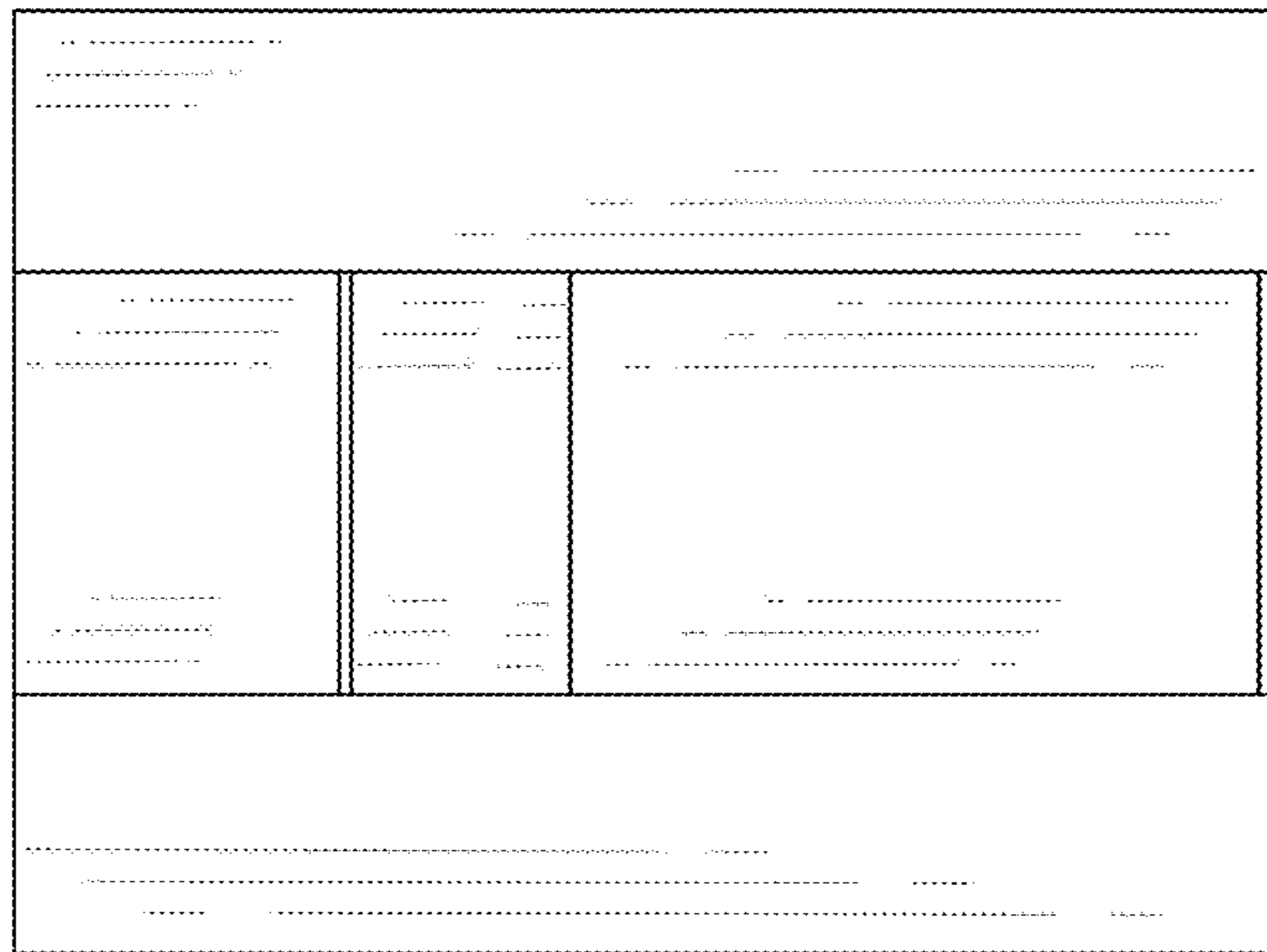

FIG.6



FIG. 7