



US00D943266S

(12) **United States Design Patent** (10) **Patent No.:** **US D943,266 S**
Knapp (45) **Date of Patent:** **** Feb. 15, 2022**

(54) **UMBRELLA**
(71) Applicant: **Paul Knapp**, Lauderdale Lakes, FL (US)
(72) Inventor: **Paul Knapp**, Lauderdale Lakes, FL (US)
(**) Term: **15 Years**
(21) Appl. No.: **29/712,614**
(22) Filed: **Nov. 9, 2019**
(51) **LOC (13) Cl.** **03-03**
(52) **U.S. Cl.**
USPC **D3/5**
(58) **Field of Classification Search**
USPC D3/5, 6, 10
CPC ... A45B 11/00; A45B 2011/005; A45B 15/00;
A45B 17/00; A45B 2017/005; A45B
19/00; A45B 2019/001; A45B 2019/004;
A45B 2019/026; A45B 19/08; A45B
23/00; A45B 2023/0006; A45B 2023/012;
A45B 2023/0025; A45B 2023/0031;
A45B 2023/0093; A45B 25/00; A45B
25/18; A45B 25/20; A45B 25/22
See application file for complete search history.

(56) **References Cited**
U.S. PATENT DOCUMENTS
6,305,394 B1 * 10/2001 Reese A45B 11/00
135/20.1
D516,294 S * 3/2006 Olson D3/5
D546,551 S * 7/2007 de Oliveira Santos D3/5
D586,550 S * 2/2009 Hermanson D3/10
7,503,336 B2 * 3/2009 Labarbera A45B 25/18
135/16

(Continued)

OTHER PUBLICATIONS

Simply Shade Umbrella, Outdoor Umbrellas, houzz.com, <https://www.houzz.com/products/simply-shade-amelia-9-half-polyester-patio-umbrella-in-stone-prvw-vr~168173819> (Year: 2021).*

(Continued)

Primary Examiner — Steven J Czyz

(74) *Attorney, Agent, or Firm* — Lott & Fischer, P.L.

(57) **CLAIM**

The ornamental design for an umbrella, as shown and described.

DESCRIPTION

FIG. 1 is a side elevation view of an umbrella showing my new design;
FIG. 2 is a bottom perspective view thereof;
FIG. 3 is a second bottom perspective view thereof;
FIG. 4 is a top perspective view thereof;
FIG. 5 is a top plan view thereof;
FIG. 6 is a bottom plan view thereof;
FIG. 7 is a side elevation view of the umbrella shown in a closed configuration;
FIG. 8 is a top plan view thereof;
FIG. 9 is a bottom plan view thereof;
FIG. 10 is a top perspective view thereof;
FIG. 11 is a side elevation view of a second embodiment of the umbrella showing my new design;
FIG. 12 is a bottom perspective thereof;
FIG. 13 is a second bottom perspective view thereof;
FIG. 14 is a top perspective view thereof;
FIG. 15 is a top plan view thereof;
FIG. 16 is a bottom plan view thereof;
FIG. 17 is a side elevation view of the umbrella shown in a closed configuration;
FIG. 18 is a top plan view thereof;
FIG. 19 is a bottom plan view thereof; and,
FIG. 20 is a top perspective view thereof.
The broken lines depict portions of the article that form no part of the claimed design.

1 Claim, 18 Drawing Sheets

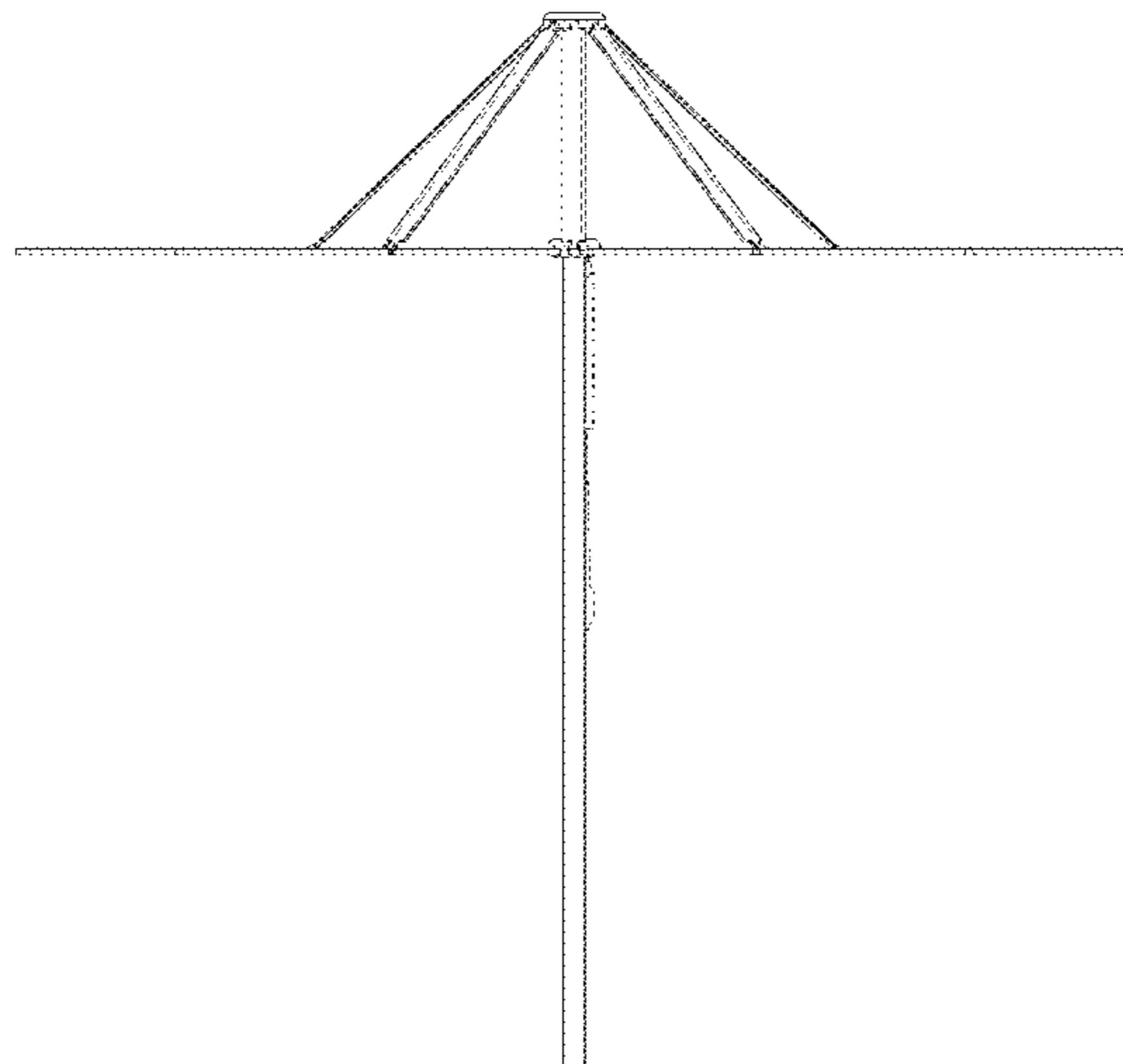

(56)

References Cited

U.S. PATENT DOCUMENTS

D600,439 S * 9/2009 Zonsius D3/5
 D613,492 S * 4/2010 van Genugten D3/5
 D638,622 S * 5/2011 He D3/5
 D649,617 S * 11/2011 Bandini D21/837
 D668,443 S * 10/2012 Sims, II D3/5
 D707,037 S * 6/2014 Tetsuro D3/5
 8,807,513 B2 * 8/2014 Volin A45B 17/00
 248/521
 9,232,836 B1 * 1/2016 Zaccaro E02D 5/801
 D759,367 S * 6/2016 Zaccaro A45B 25/10
 D3/5
 10,548,378 B2 * 2/2020 Mundt A45B 25/02
 10,609,994 B2 * 4/2020 Vanderminden F16M 13/00
 D899,069 S * 10/2020 Holbrook F16M 13/00
 D3/5
 D899,070 S * 10/2020 Holbrook A45B 17/00
 D3/5

D899,761 S * 10/2020 Holbrook A45B 25/02
 D3/5
 D899,762 S * 10/2020 Holbrook A45B 11/00
 D3/5
 D907,355 S * 1/2021 Akin A45B 25/18
 D3/5
 10,881,176 B1 * 1/2021 Holbrook A45B 11/00
 D911,018 S * 2/2021 Fisher D3/5
 10,959,500 B1 * 3/2021 Holbrook A45B 25/10
 2008/0006313 A1 * 1/2008 Wang A45B 25/02
 135/31

OTHER PUBLICATIONS

Extremis Inumbrina 380 Umbrella, casadesigngroup.com, <https://casadesigngroup.com/products/inumbrina-380-umbrella> (Year: 2021).*
 Inumbrina Umbrella, contemporist.com, <https://www.contemporist.com/the-abachus-table-by-dirk-wynants-of-extremis/> (Year: 2010).*

* cited by examiner

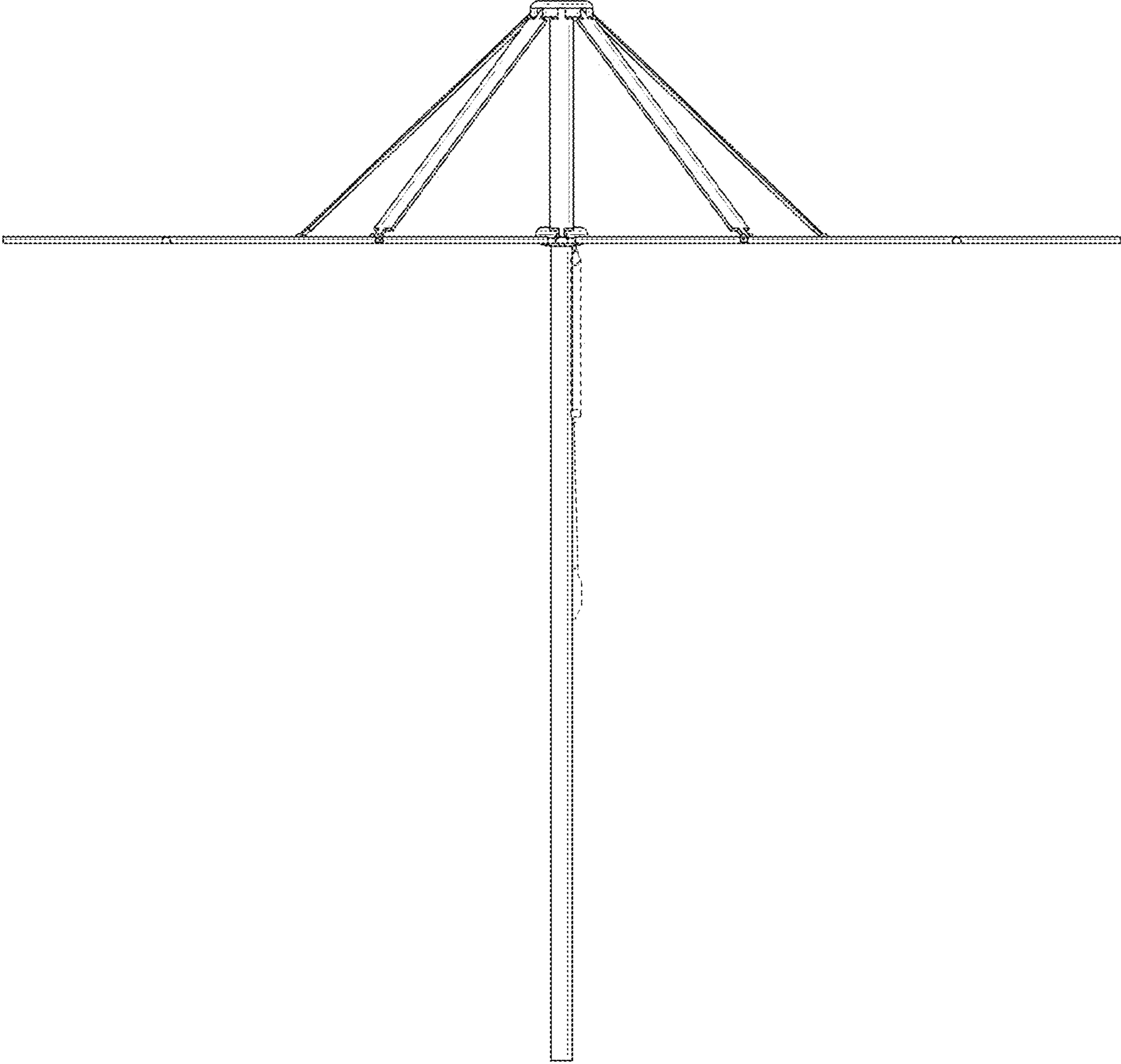

FIG. 1



FIG. 2

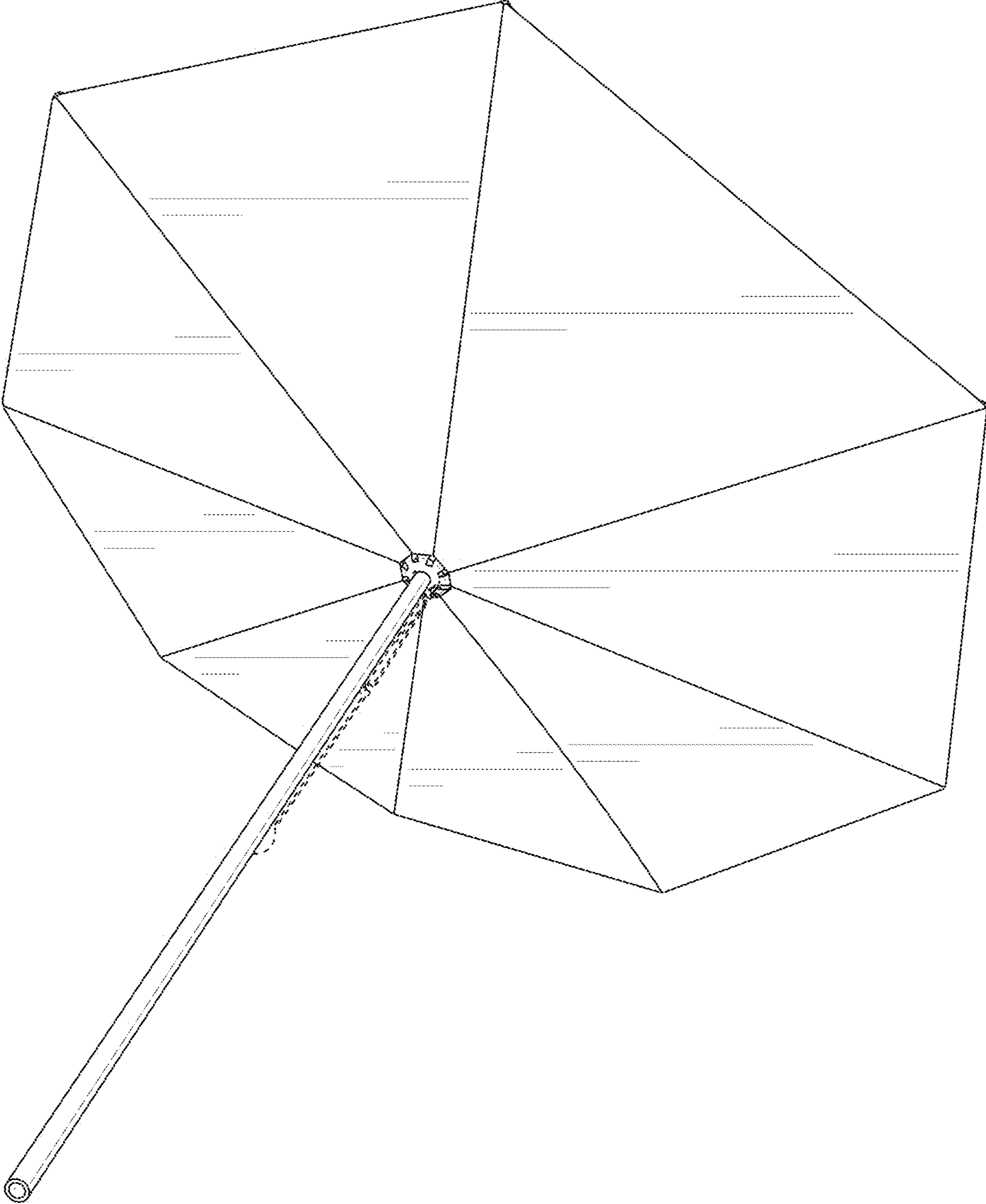

FIG. 3

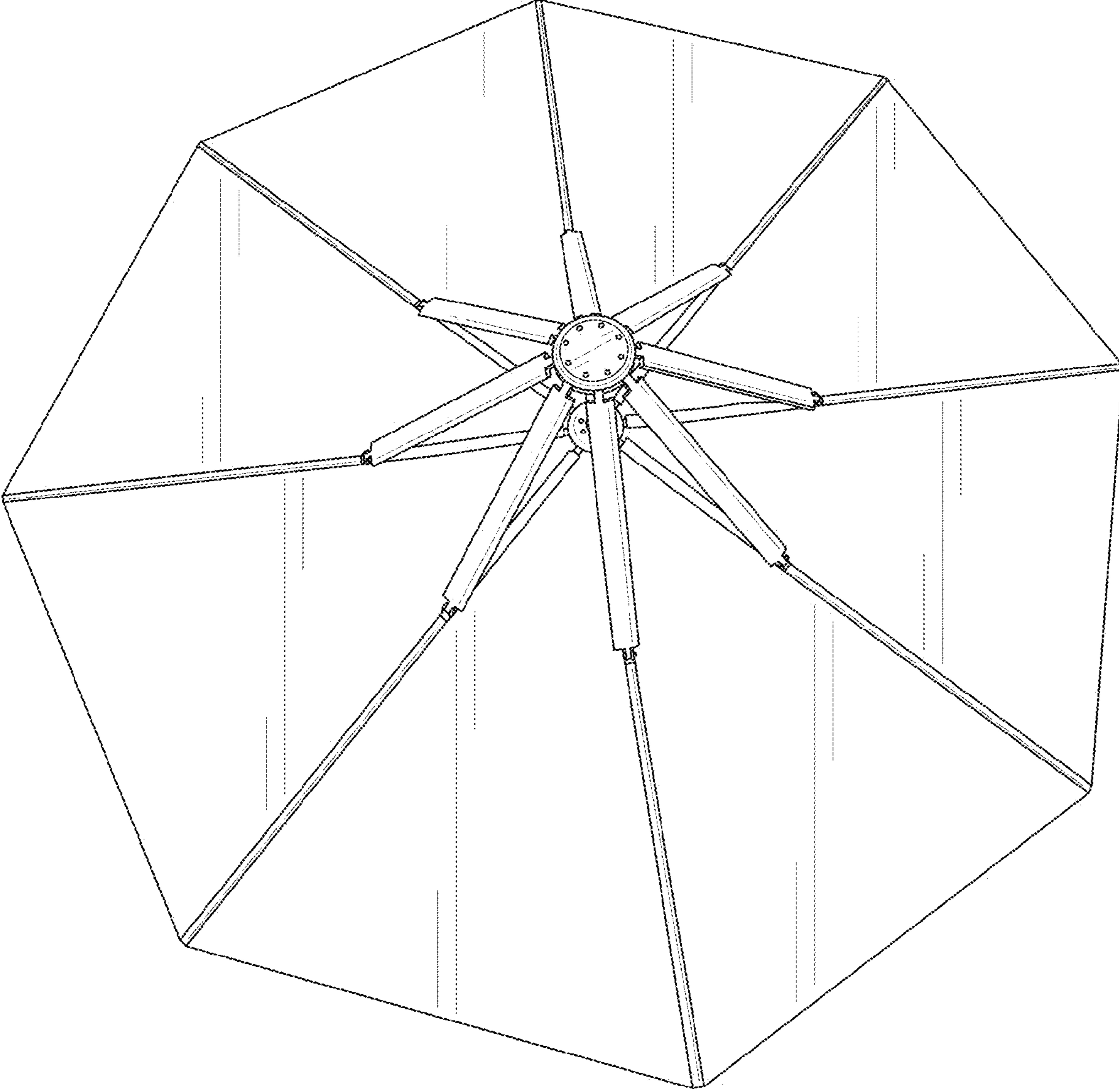

FIG. 4

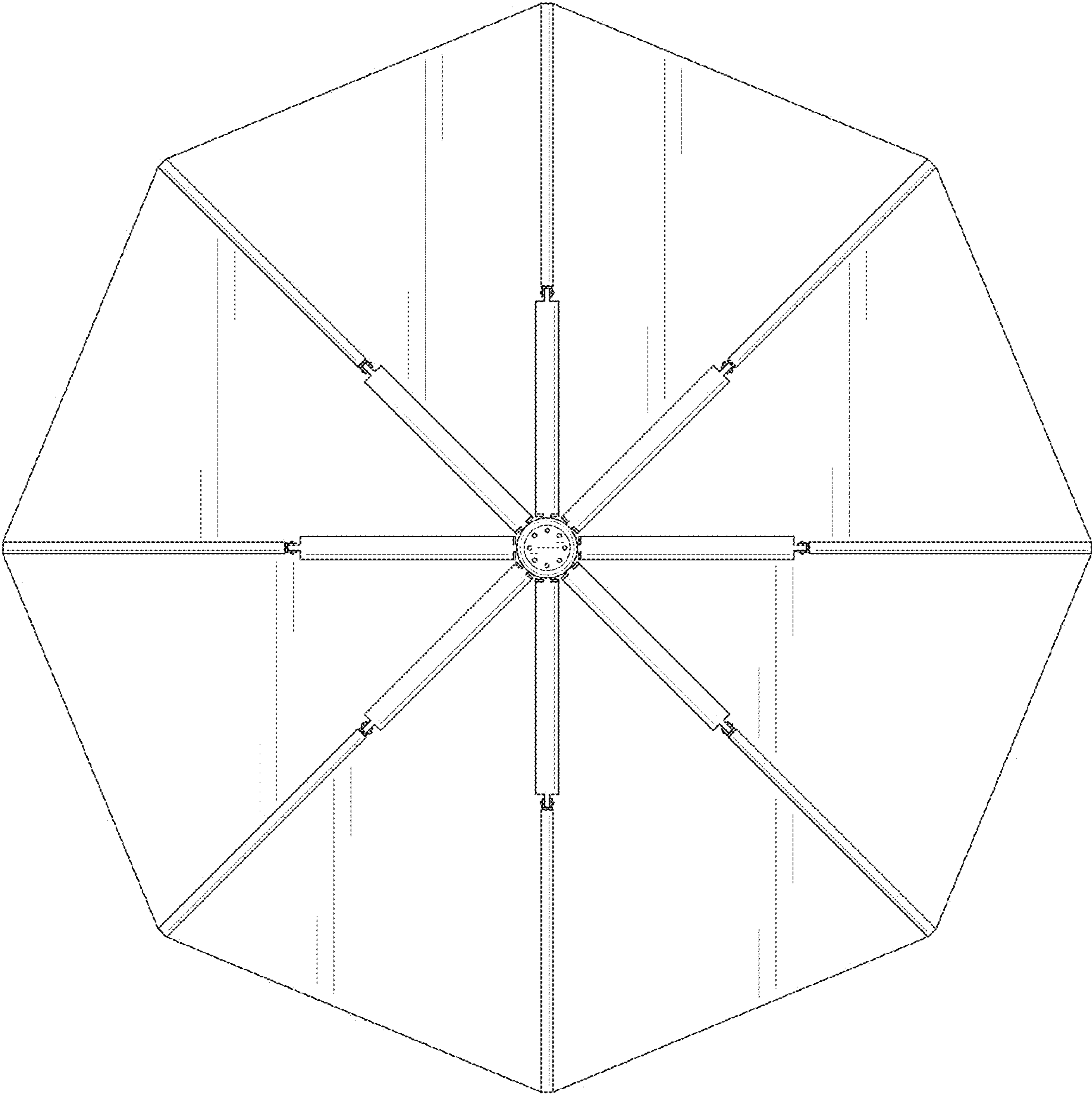

FIG. 5

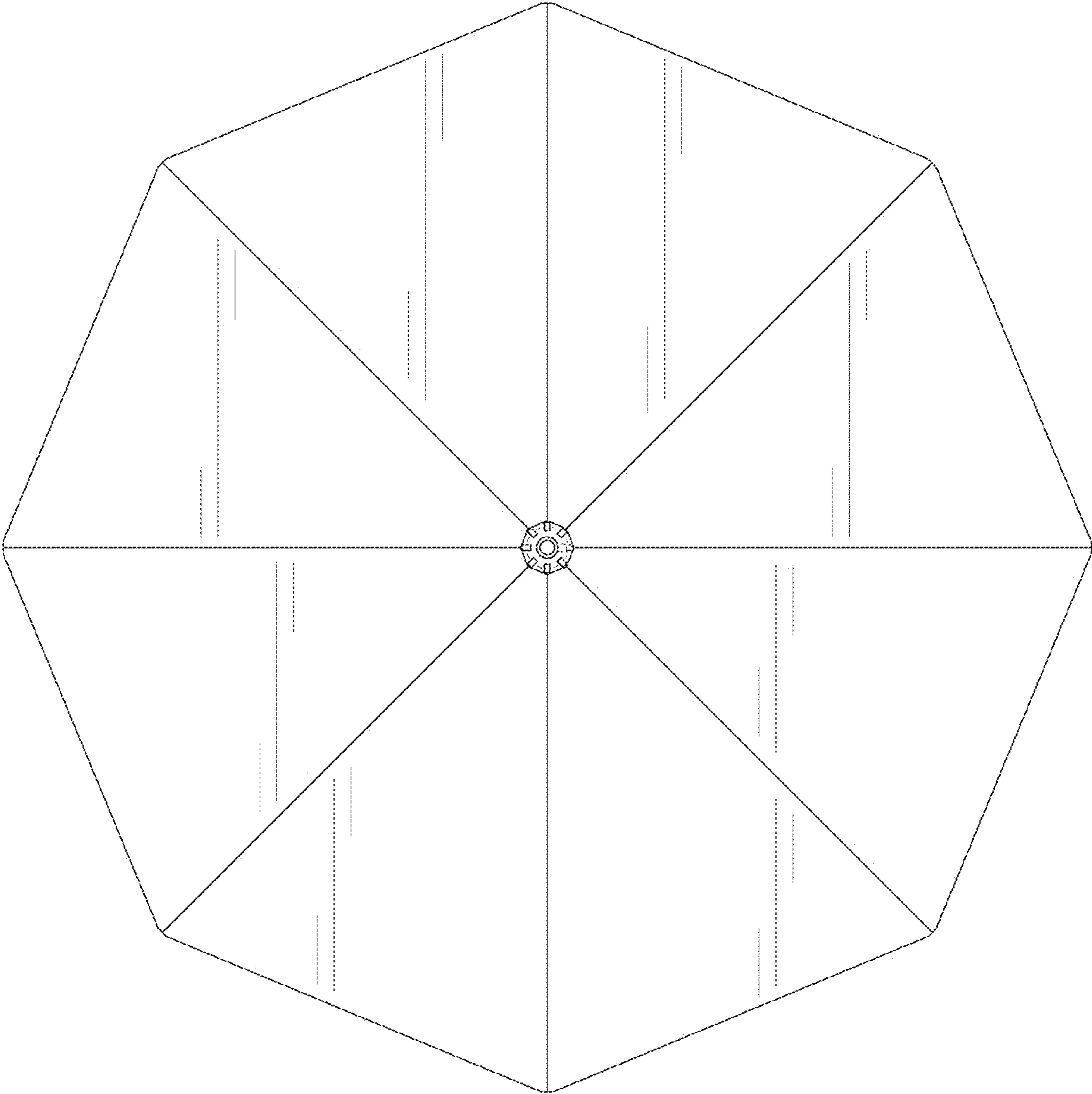

FIG. 6



FIG. 7

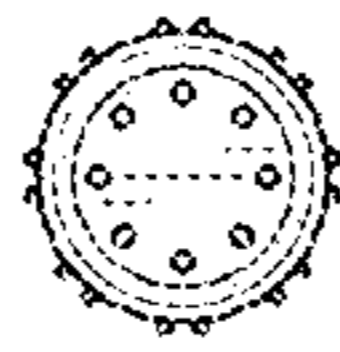

FIG. 8

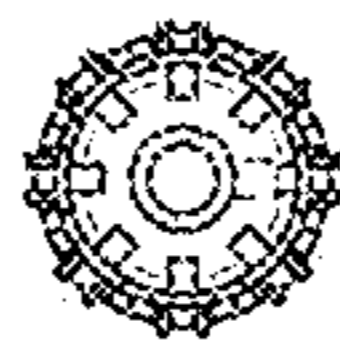

FIG. 9

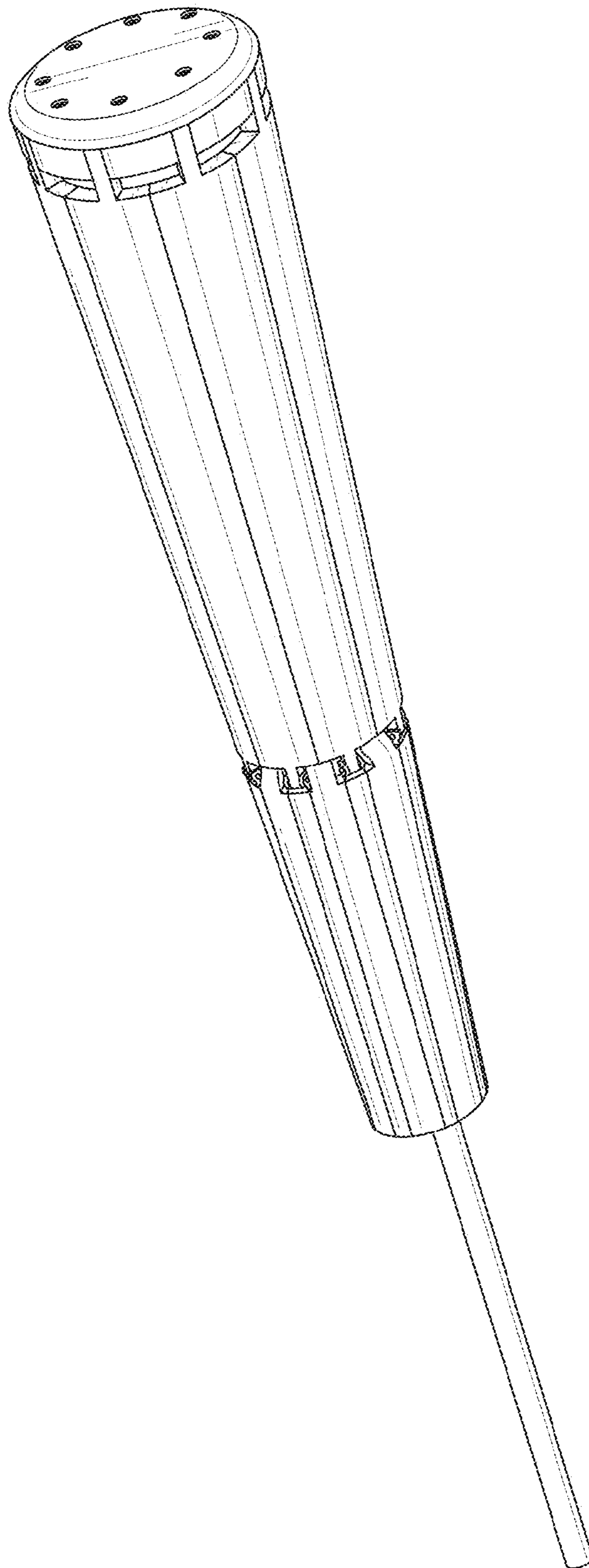

FIG. 10

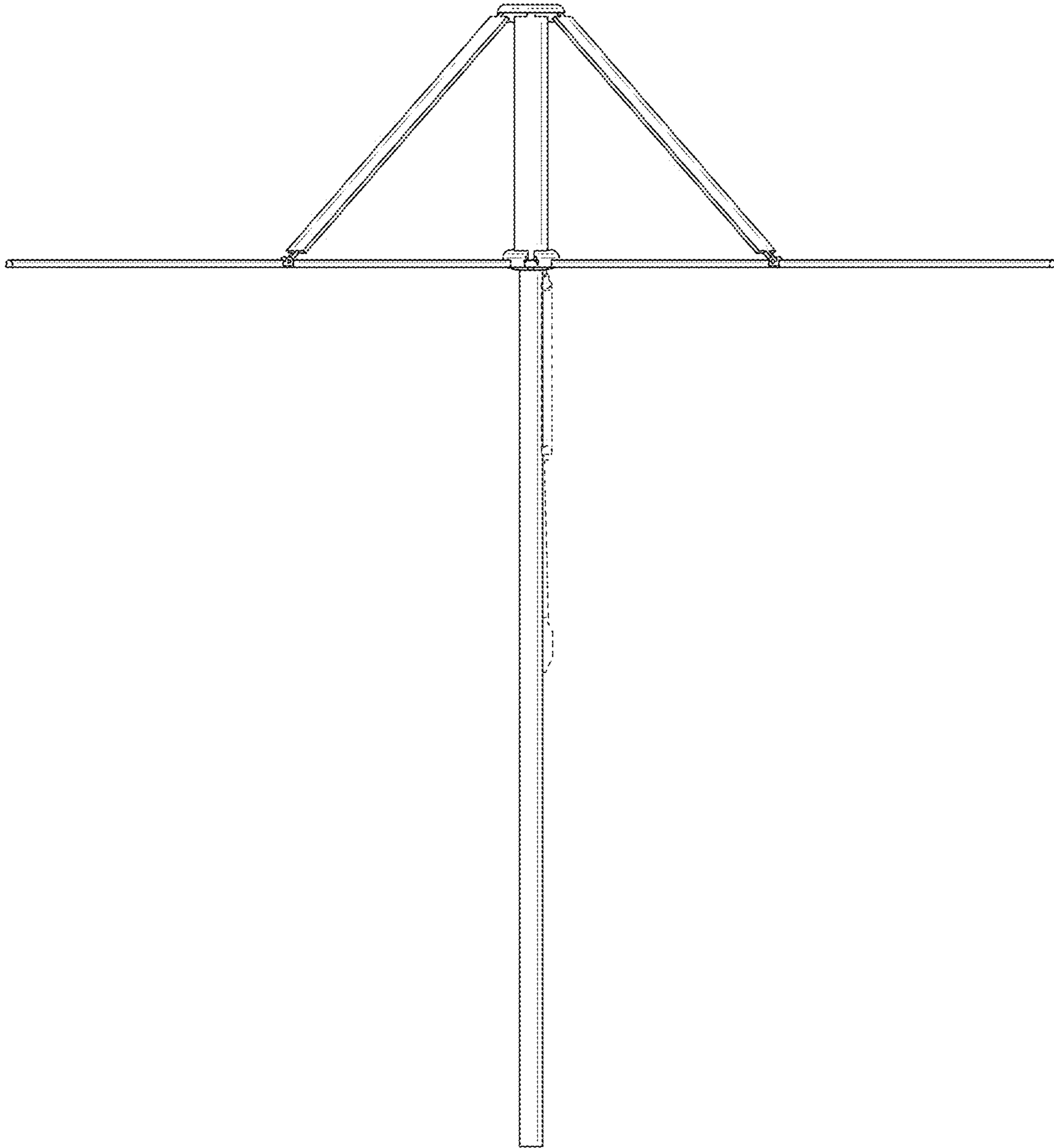

FIG. 11



FIG. 12

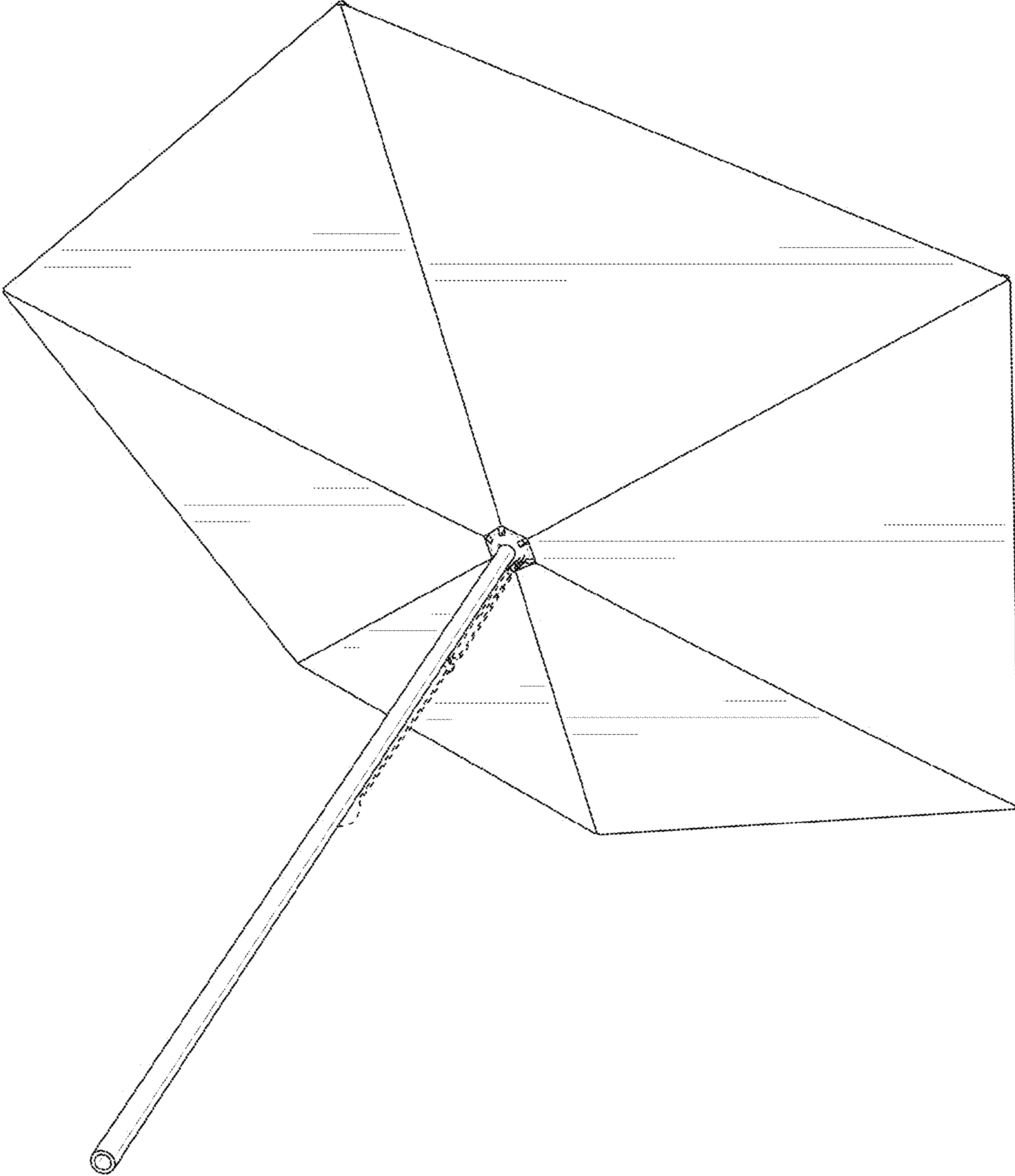

FIG. 13

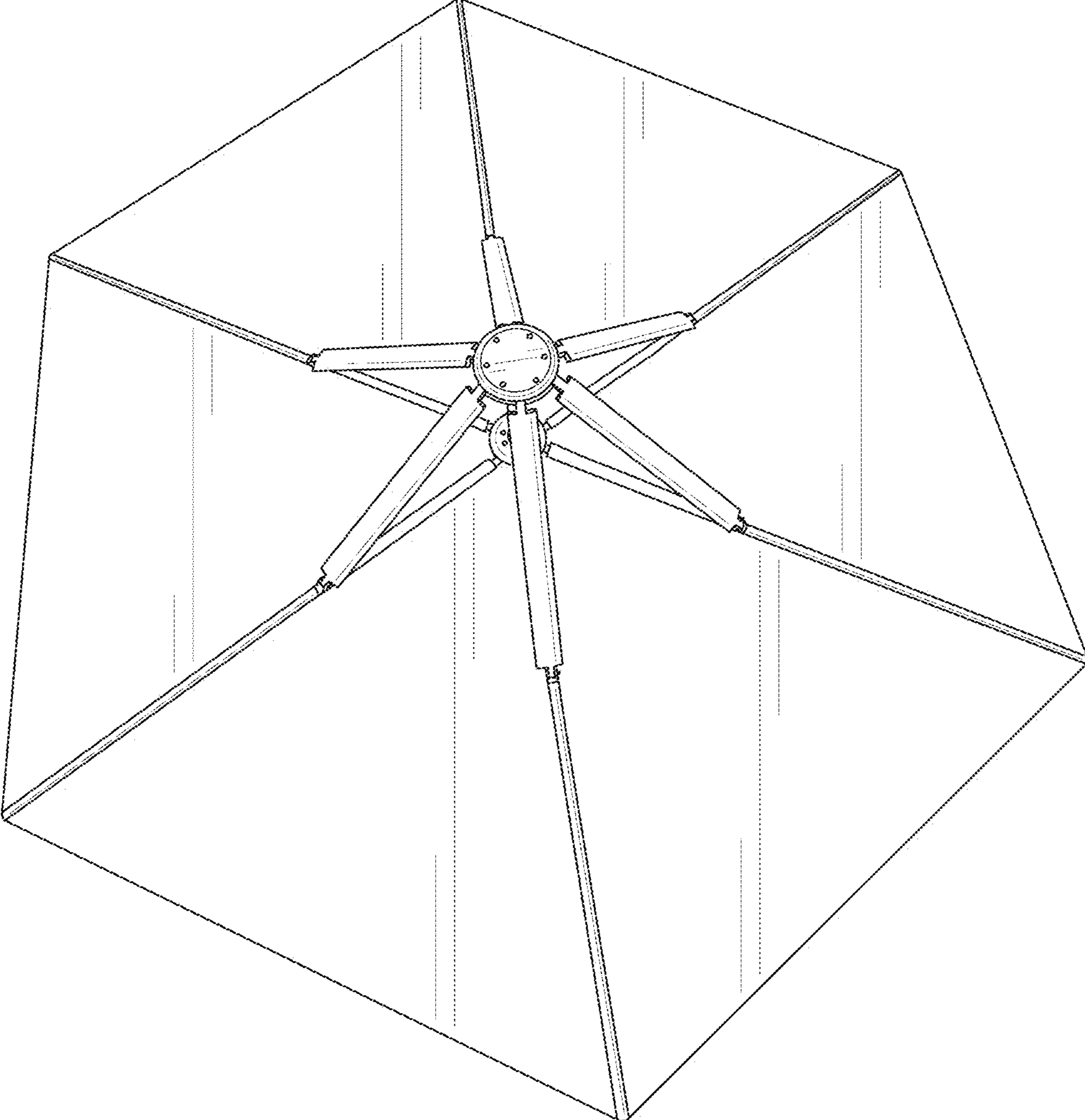

FIG. 14

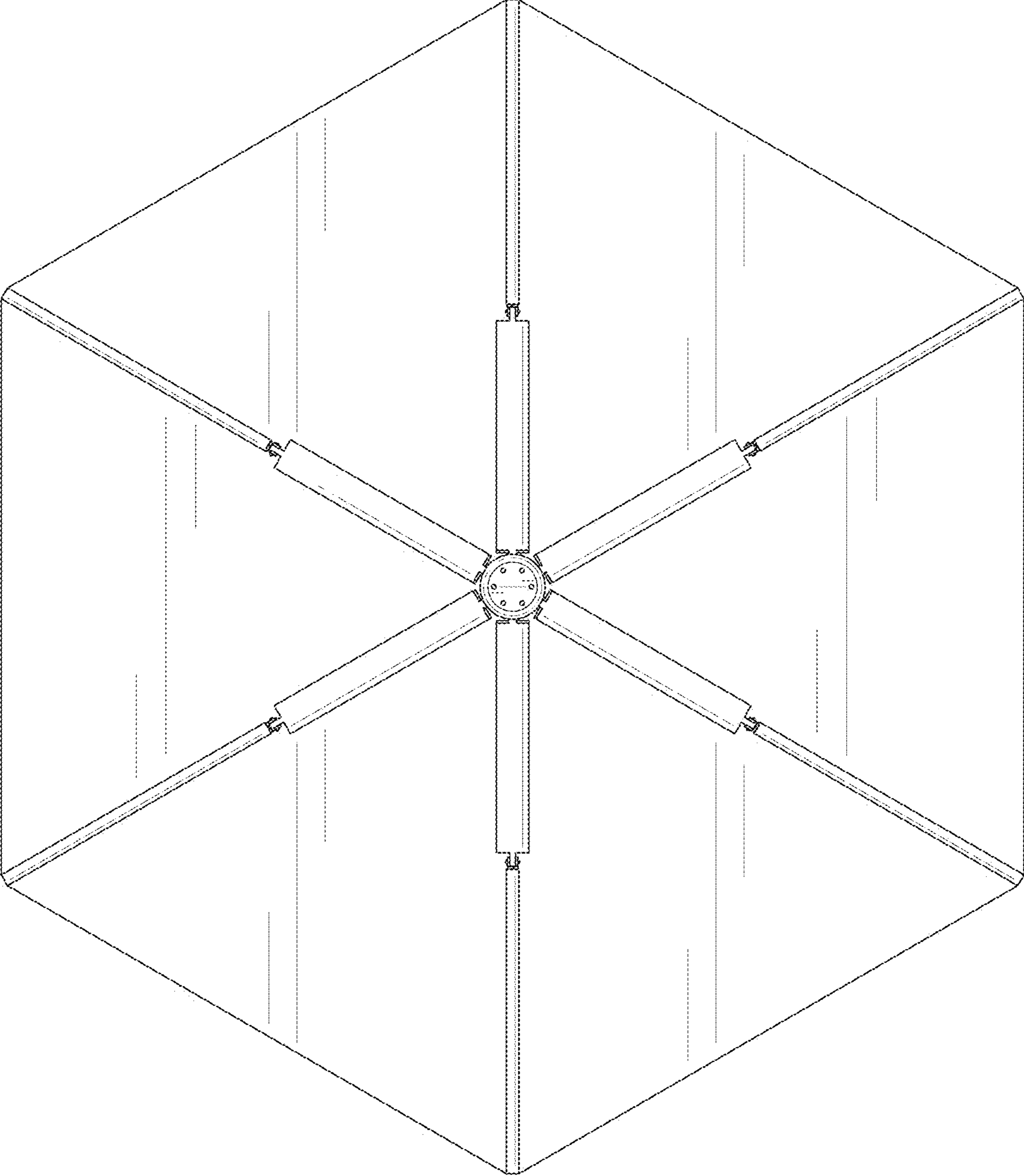

FIG. 15

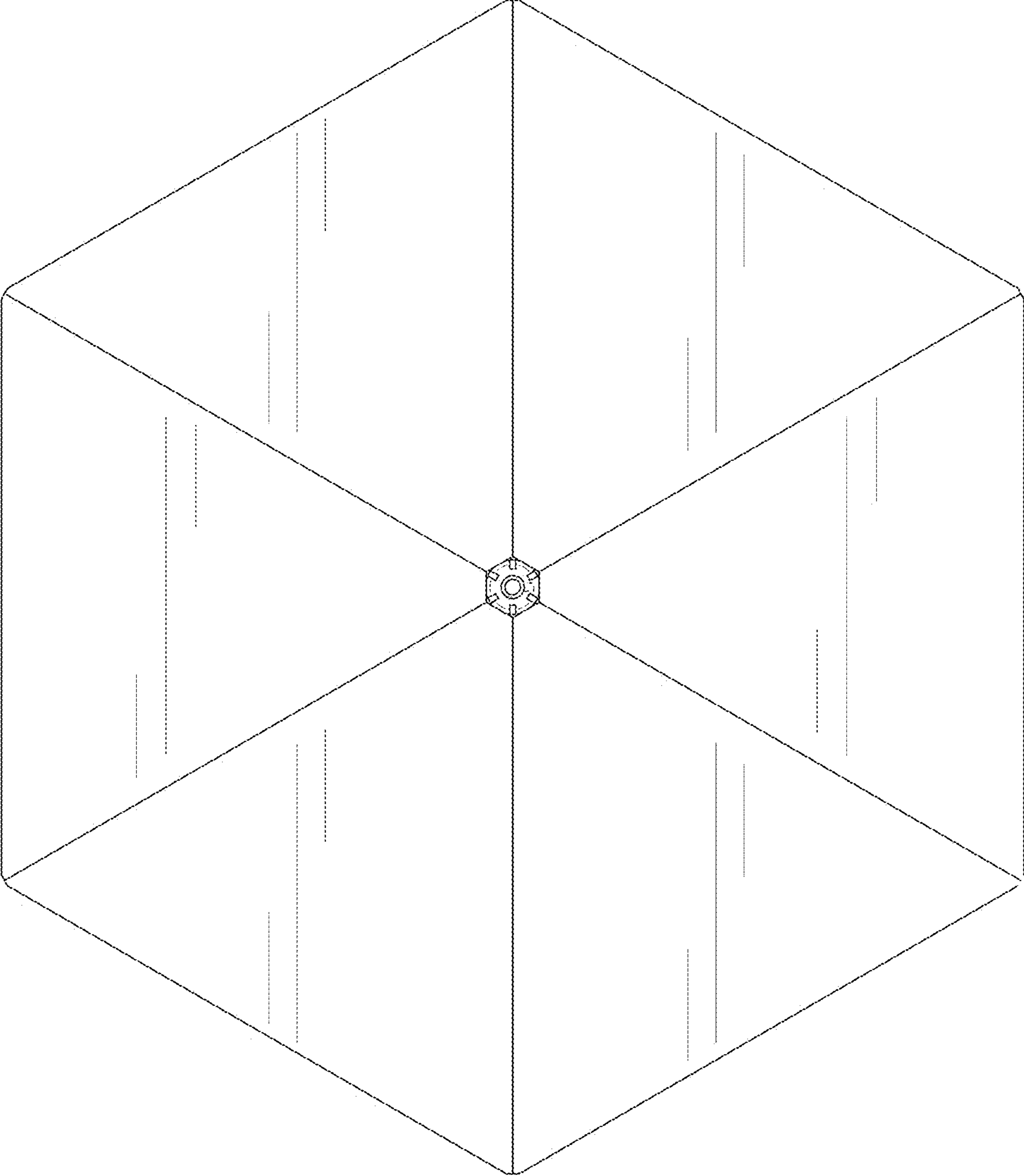

FIG. 16

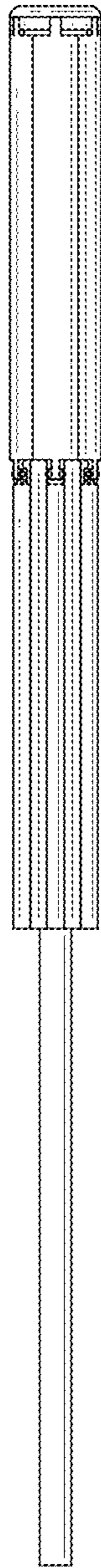

FIG. 17



FIG. 18

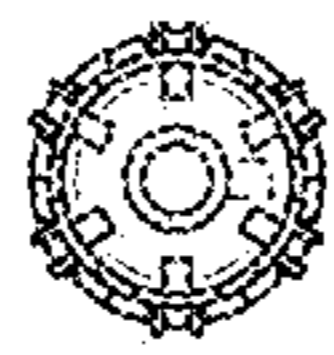

FIG. 19

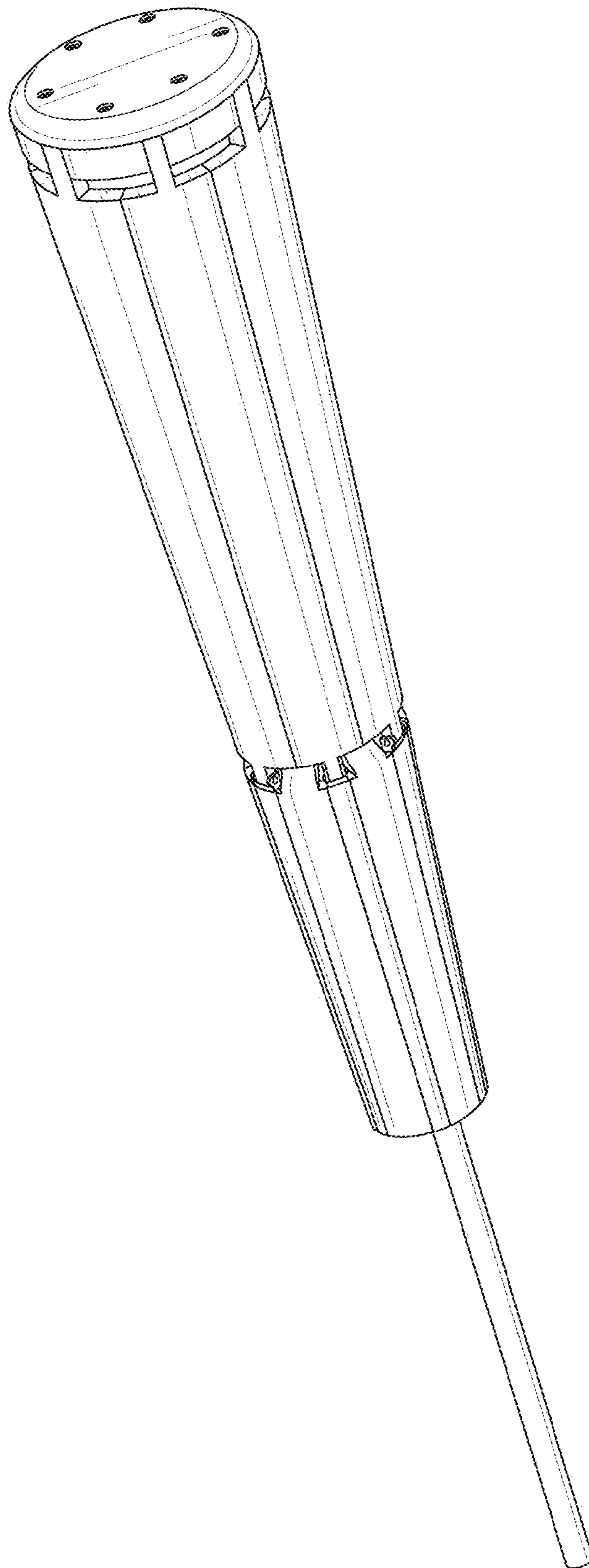

FIG. 20