



US00D943209S

(12) **United States Design Patent** (10) **Patent No.:** **US D943,209 S**
Miller (45) **Date of Patent:** **** Feb. 8, 2022**

(54) **HAIR CLIPPER**

(71) Applicant: **Andis Company**, Sturtevant, WI (US)

(72) Inventor: **Jassen R. Miller**, Trevor, WI (US)

(73) Assignee: **Andis Company**, Sturtevant, WI (US)

(**) Term: **15 Years**

(21) Appl. No.: **29/709,923**

(22) Filed: **Oct. 18, 2019**

(51) **LOC (13) Cl.** **28-03**

(52) **U.S. Cl.**
USPC **D28/53**

(58) **Field of Classification Search**
USPC D28/49-54

(Continued)

(56) **References Cited**

U.S. PATENT DOCUMENTS

D720,887 S * 1/2015 Gross D28/53
D787,746 S * 5/2017 Werner D28/53

(Continued)

Primary Examiner — Jennifer Rivard

(74) *Attorney, Agent, or Firm* — Reinhart Boerner Van Deuren s.c.

(57) **CLAIM**

I claim the ornamental design for a hair clipper, as shown and described.

DESCRIPTION

FIG. 1 is a top perspective view of a hair clipper according to an embodiment of the invention;

FIG. 2 is a bottom perspective view of the hair clipper of FIG. 1;

FIG. 3 is a top side view of the hair clipper of FIG. 1;

FIG. 4 is a bottom side view of the hair clipper of FIG. 1;

FIG. 5 is a left side view of the hair clipper of FIG. 1;

FIG. 6 is a right side view of the hair clipper of FIG. 1;

FIG. 7 is a front side view of the hair clipper of FIG. 1;

FIG. 8 is a back side view of the hair clipper of FIG. 1;

FIG. 9 is a top perspective view of a hair clipper according to an embodiment of the invention;

FIG. 10 is a bottom perspective view of the hair clipper of FIG. 9;

FIG. 11 is a top side view of the hair clipper of FIG. 9;

FIG. 12 is a bottom side view of the hair clipper of FIG. 9;

FIG. 13 is a left side view of the hair clipper of FIG. 9;

FIG. 14 is a right side view of the hair clipper of FIG. 9;

FIG. 15 is a front side view of the hair clipper of FIG. 9;

FIG. 16 is a back side view of the hair clipper of FIG. 9;

FIG. 17 is a top perspective view of a hair clipper according to an embodiment of the invention;

FIG. 18 is a bottom perspective view of the hair clipper of FIG. 17;

FIG. 19 is a top side view of the hair clipper of FIG. 17;

FIG. 20 is a bottom side view of the hair clipper of FIG. 17;

FIG. 21 is a left side view of the hair clipper of FIG. 17;

FIG. 22 is a right side view of the hair clipper of FIG. 17;

FIG. 23 is a front side view of the hair clipper of FIG. 17;

FIG. 24 is a back side view of the hair clipper of FIG. 17;

FIG. 25 is a top perspective view of a hair clipper according to an embodiment of the invention;

FIG. 26 is a bottom perspective view of the hair clipper of FIG. 25;

FIG. 27 is a top side view of the hair clipper of FIG. 25;

FIG. 28 is a bottom side view of the hair clipper of FIG. 25;

FIG. 29 is a left side view of the hair clipper of FIG. 25;

FIG. 30 is a right side view of the hair clipper of FIG. 25;

FIG. 31 is a front side view of the hair clipper of FIG. 25;

and,

FIG. 32 is a back side view of the hair clipper of FIG. 25.

The ornamental design which is claimed is shown in solid lines in the drawings. The broken lines shown in the drawings illustrate portions of the hair clipper and form no part of the claimed design.

1 Claim, 28 Drawing Sheets

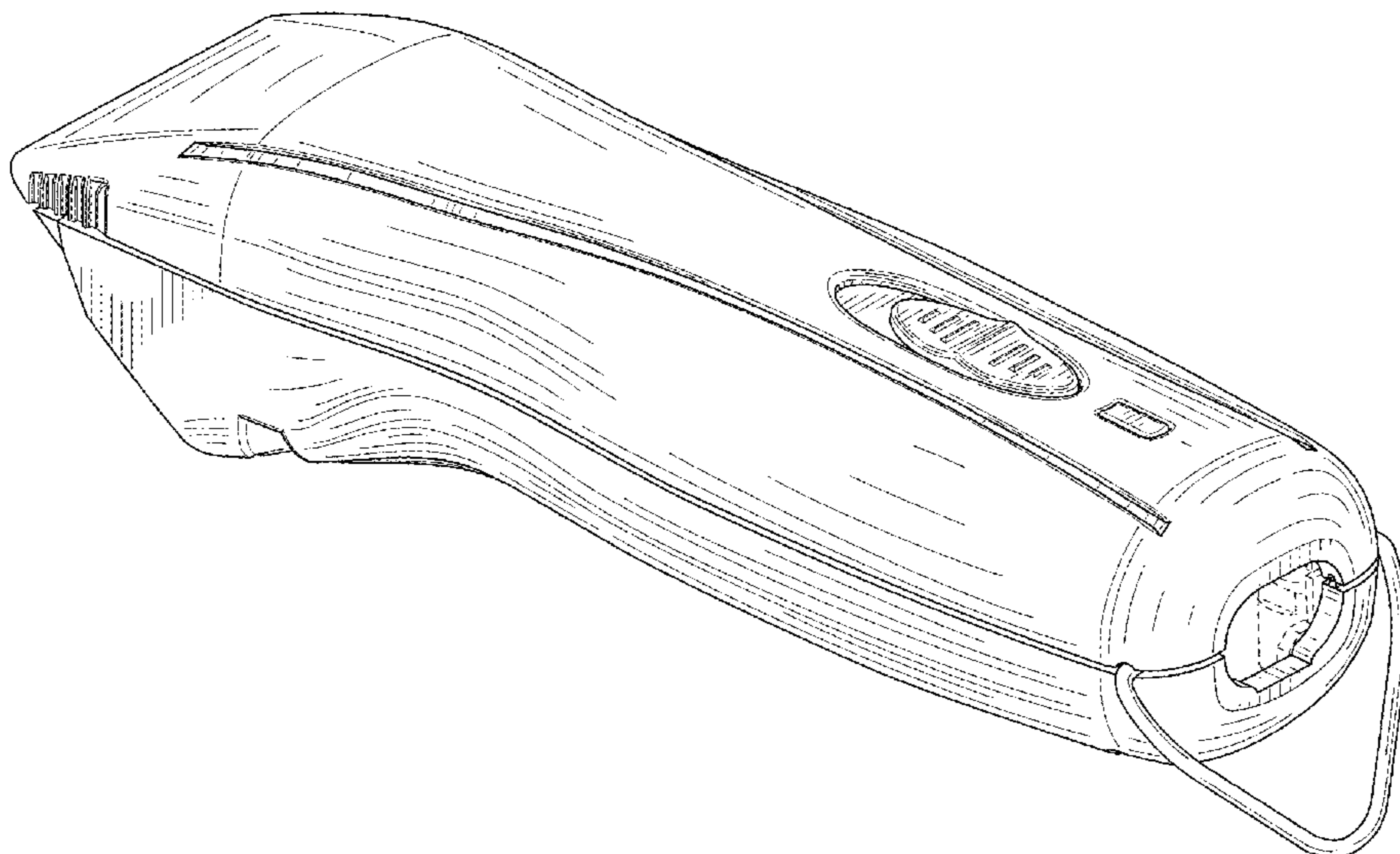

(58) **Field of Classification Search**

CPC .. B26B 19/38-3826; B26B 19/384-48; B26B
19/12; B26B 19/20-24; B26B 19/00-107
See application file for complete search history.

(56) **References Cited**

U.S. PATENT DOCUMENTS

D800,965	S	*	10/2017	Aulwes	D28/53
D844,244	S	*	3/2019	Wu	D28/53
D851,834	S	*	6/2019	Peterson, Jr.	D28/53
D859,743	S	*	9/2019	Lambrecht	D28/53
D864,483	S	*	10/2019	Chen	D28/53
D865,292	S	*	10/2019	Peterson, Jr.	D28/53
D866,859	S	*	11/2019	Chen	D28/53
D880,067	S	*	3/2020	Hu	D28/53
D898,998	S	*	10/2020	Werner	D28/53
2016/0303749	A1	*	10/2016	Ziegler	B26B 19/28

* cited by examiner

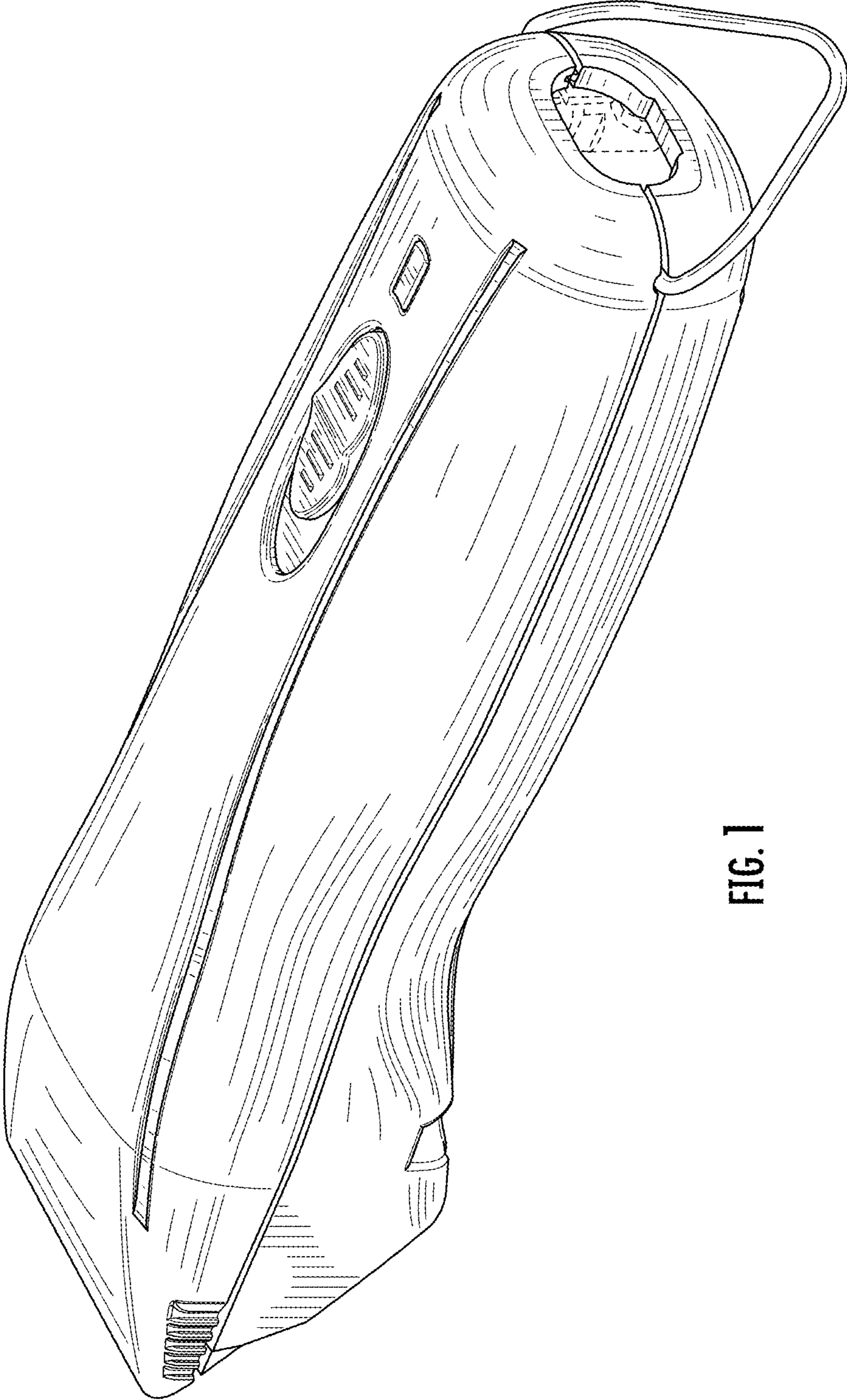

FIG. 1

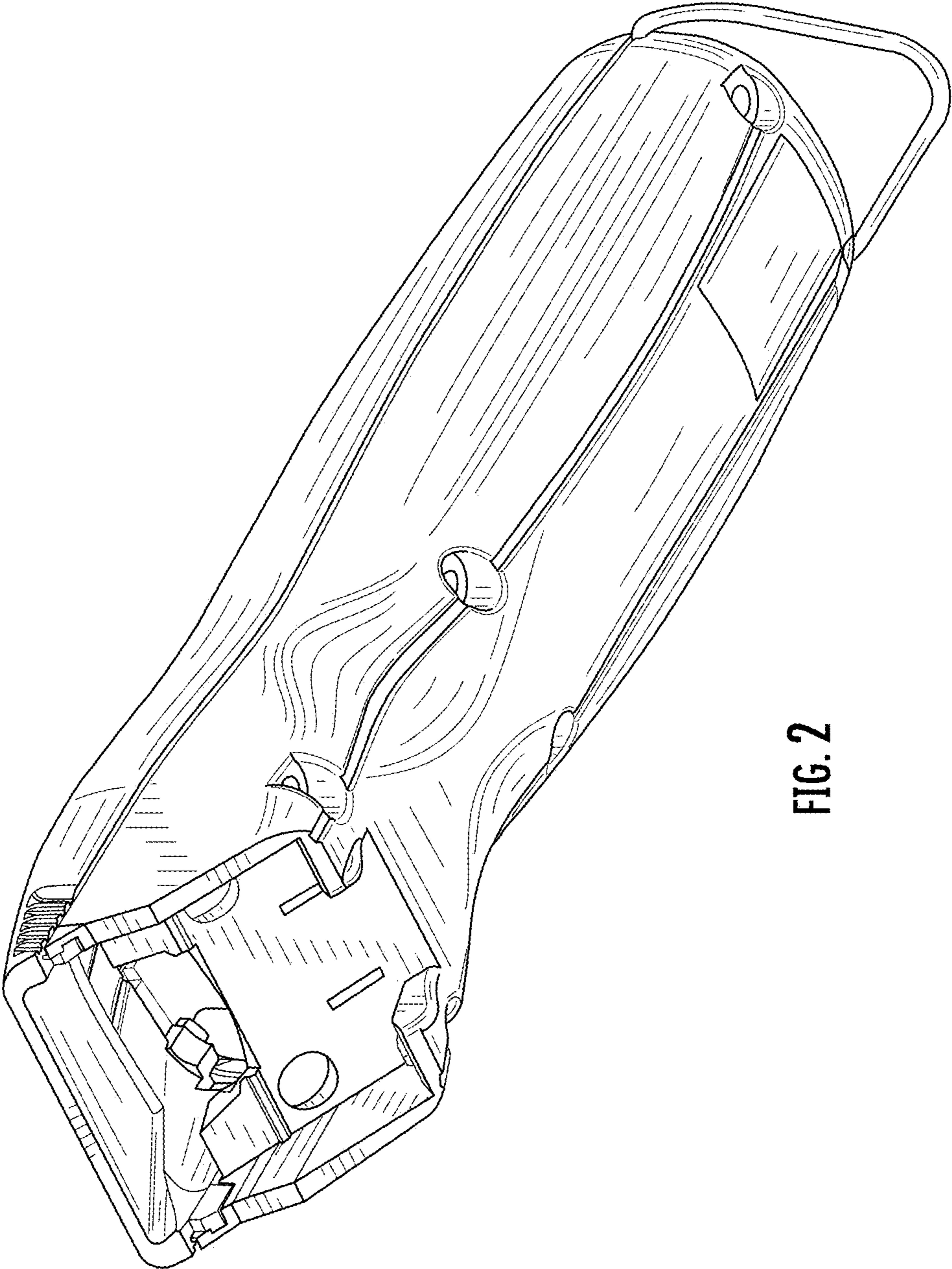

FIG. 2

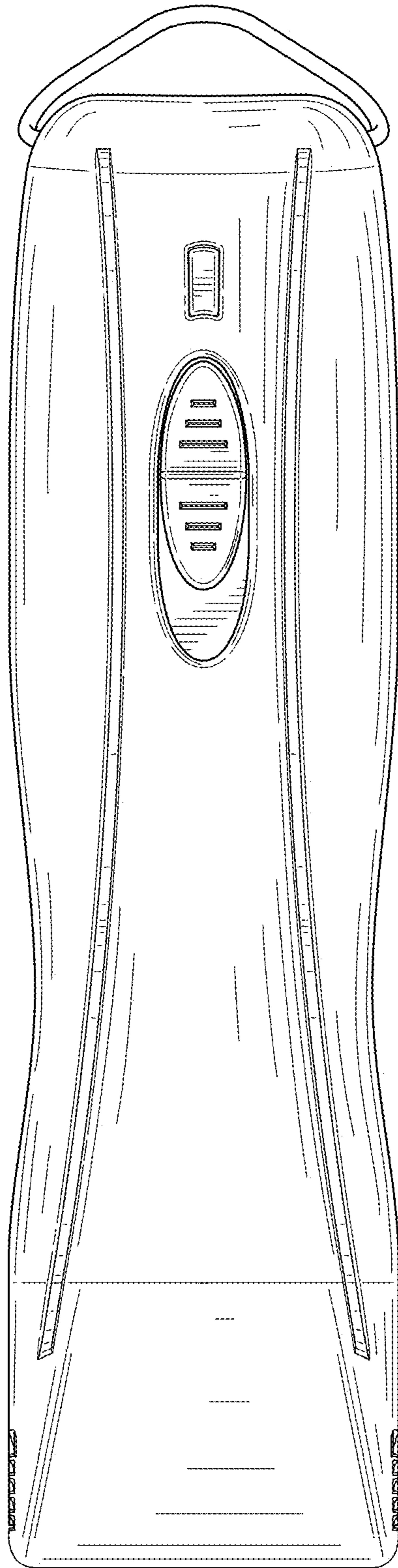

FIG. 3

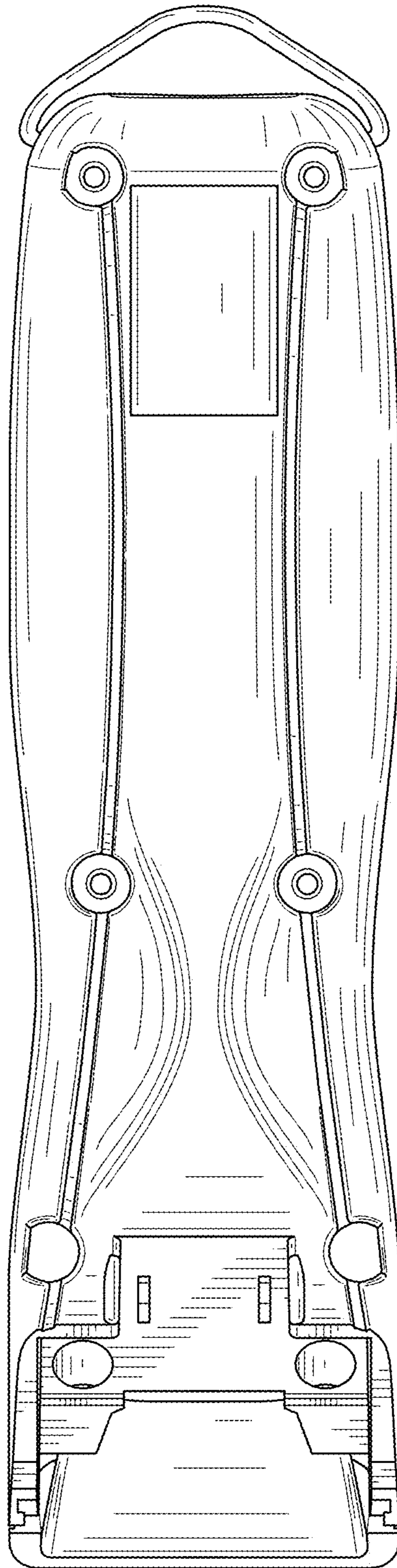

FIG. 4

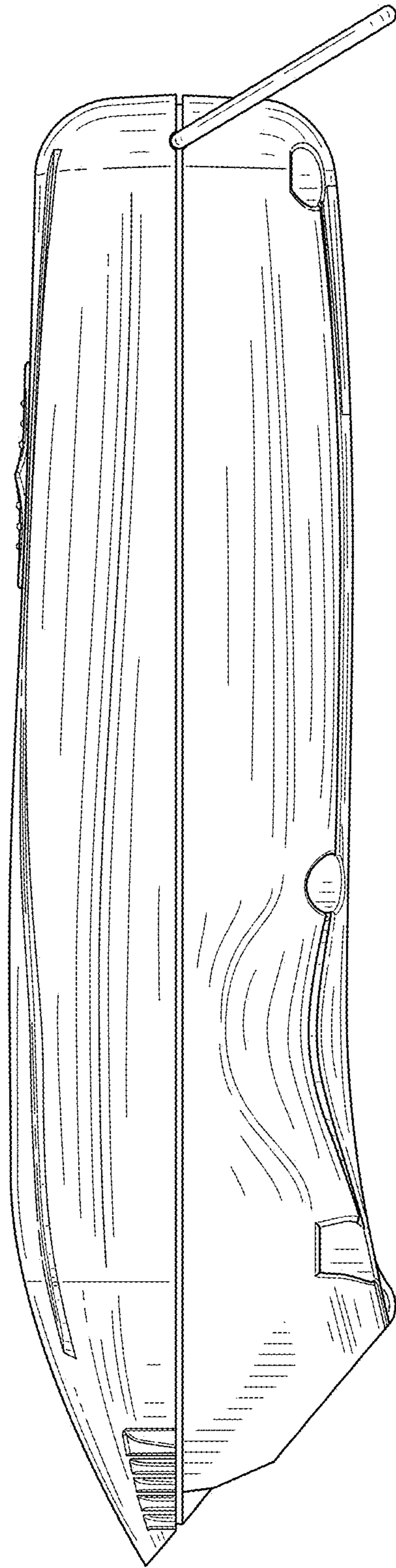

FIG. 5

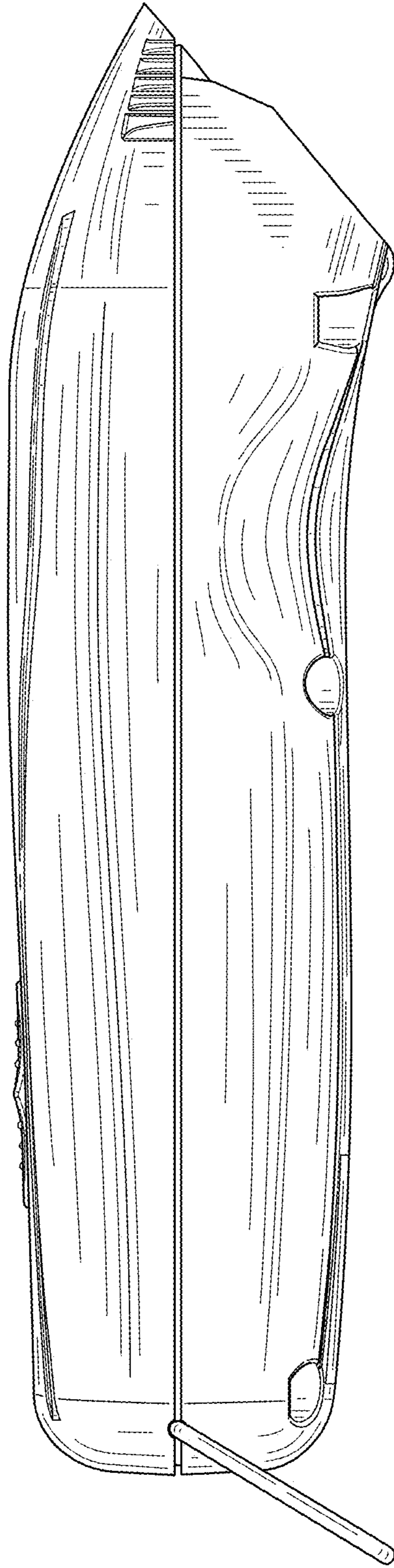

FIG. 6

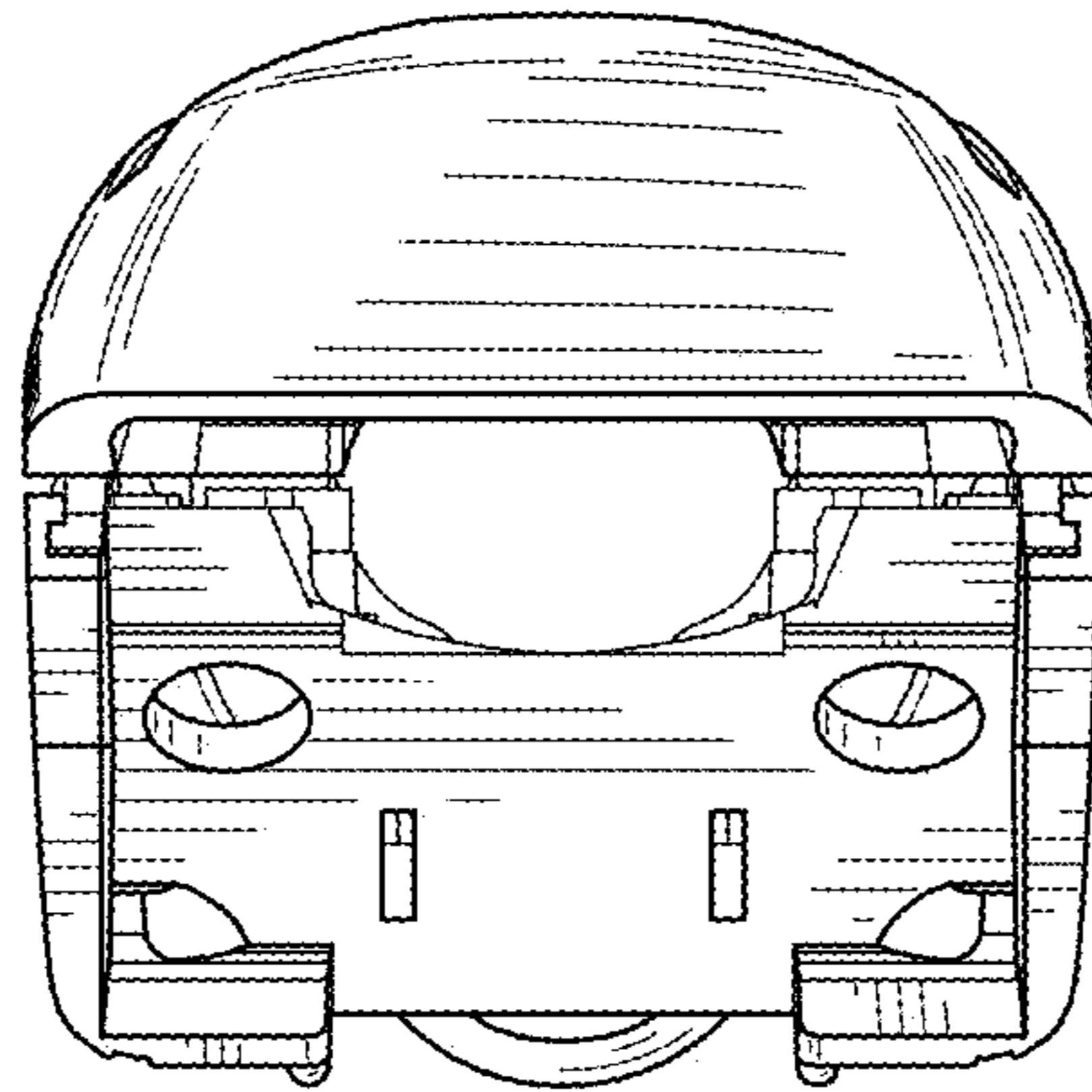

FIG. 7

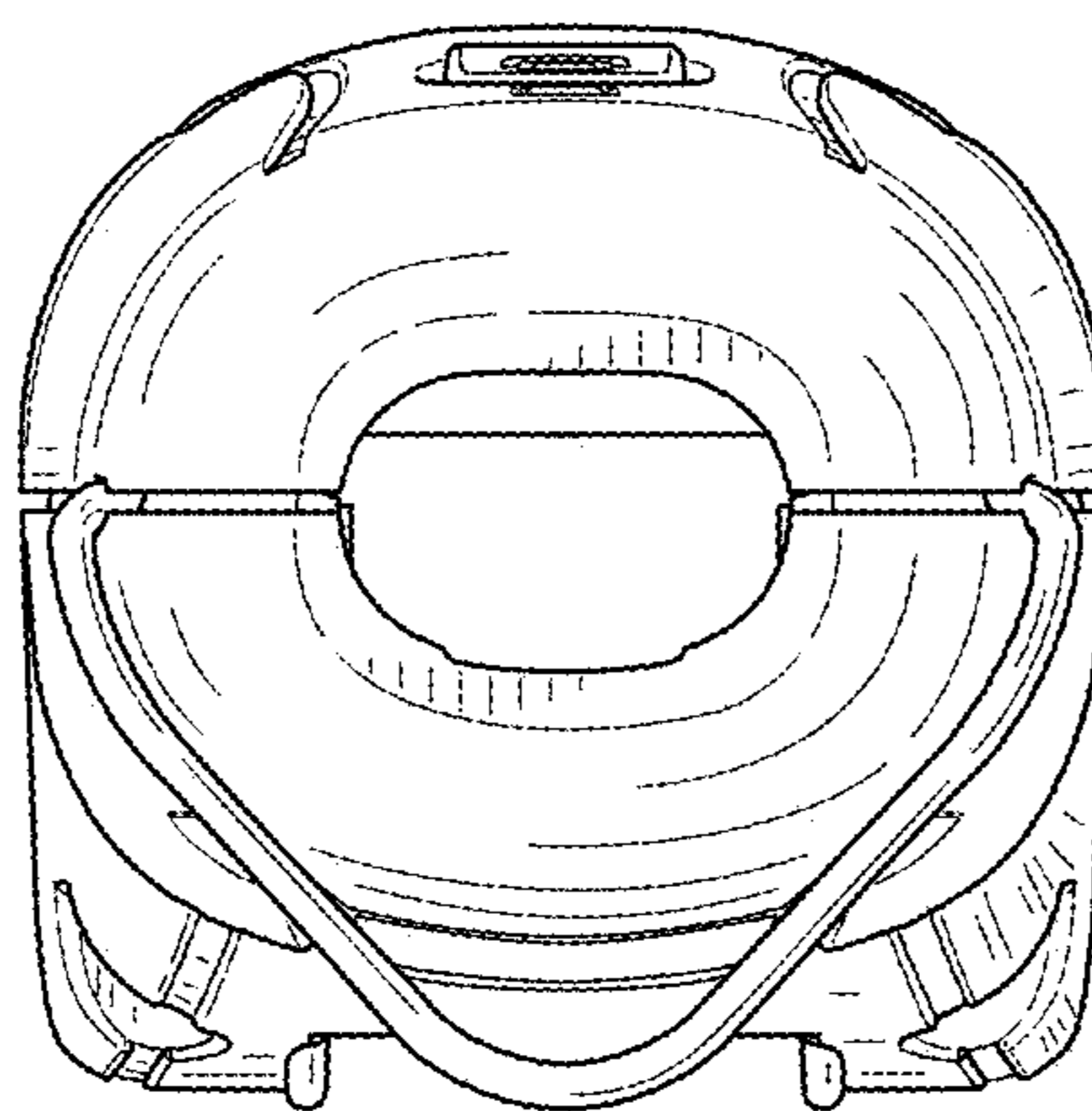

FIG. 8

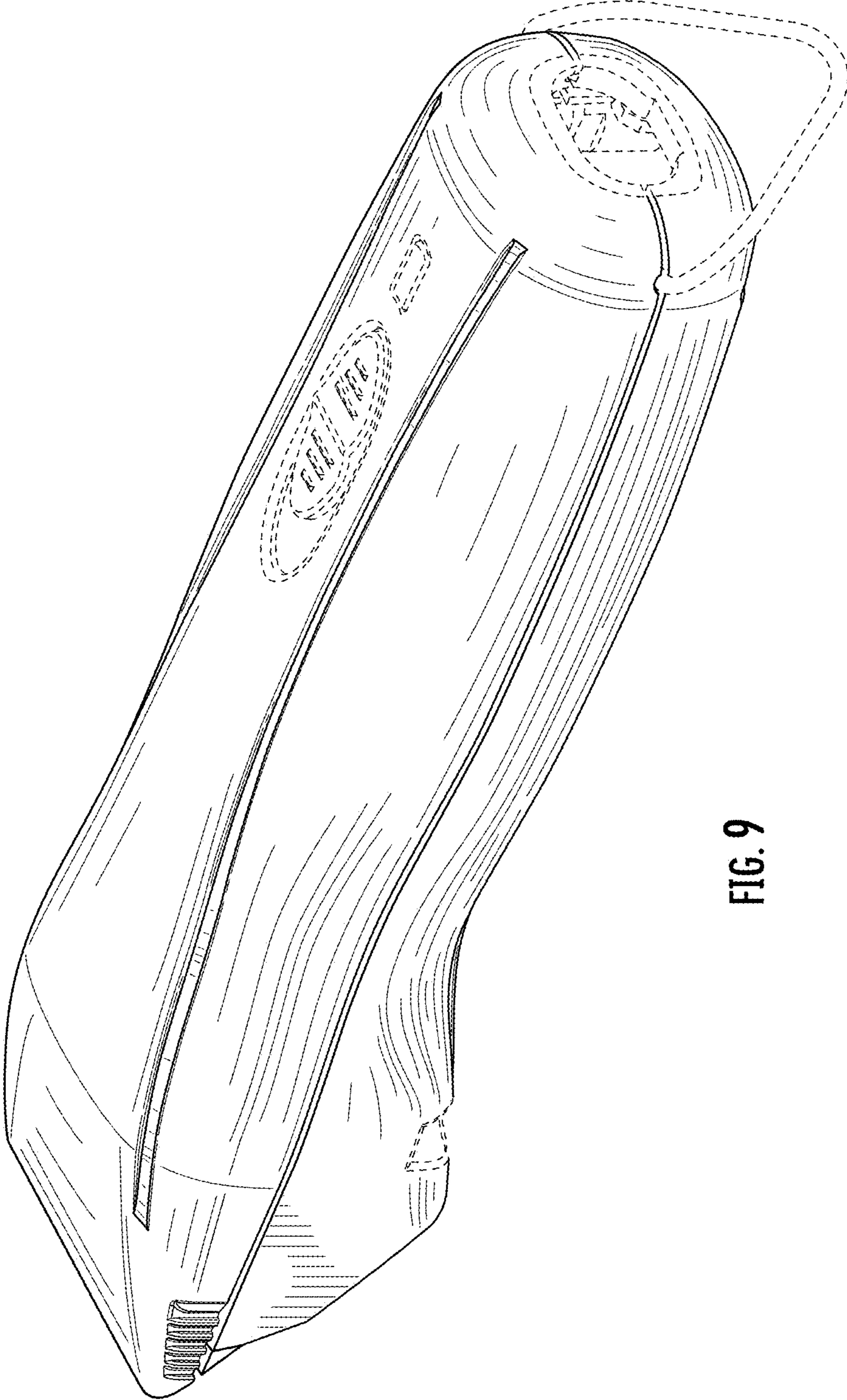

FIG. 9

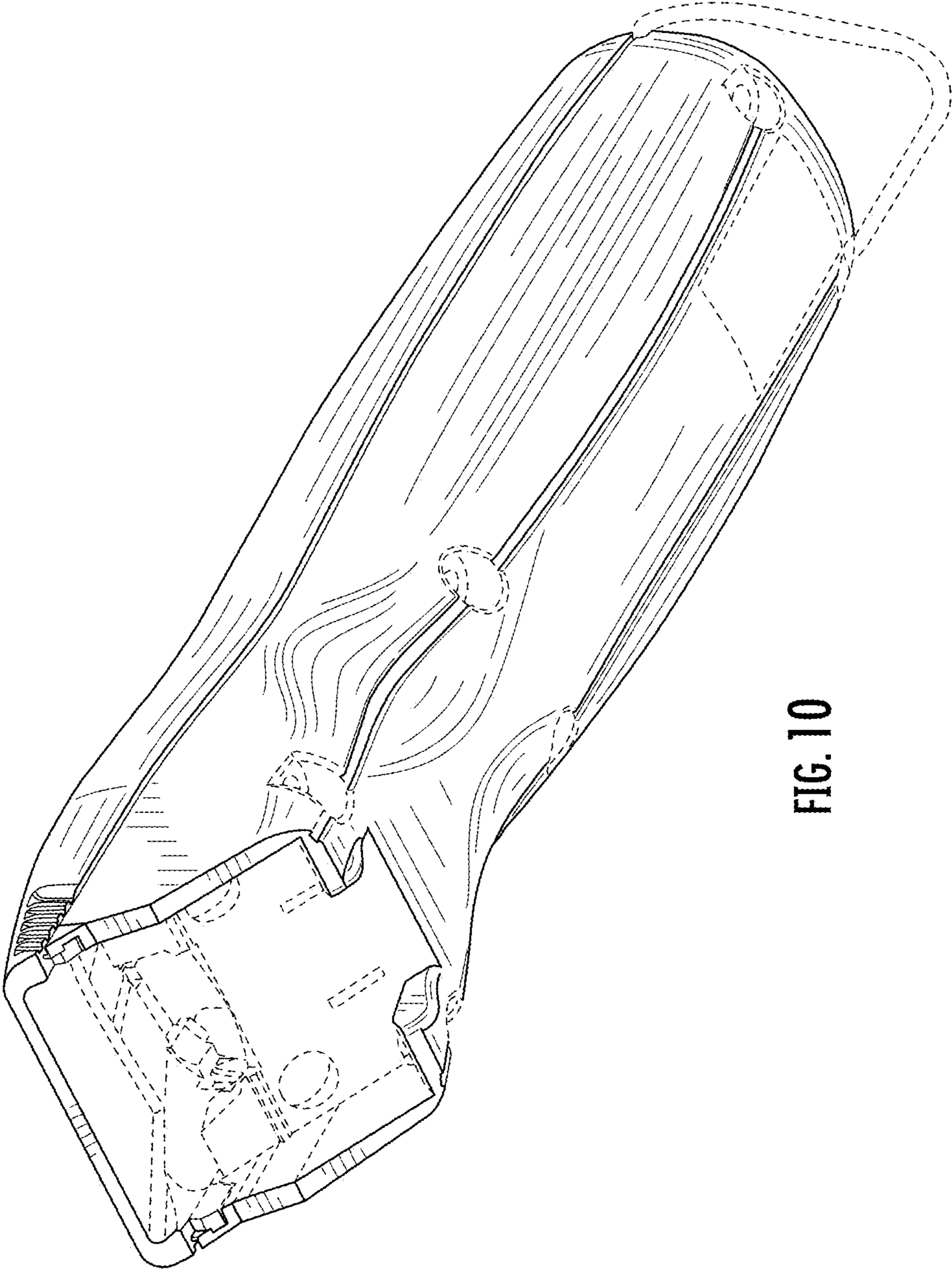

FIG. 10

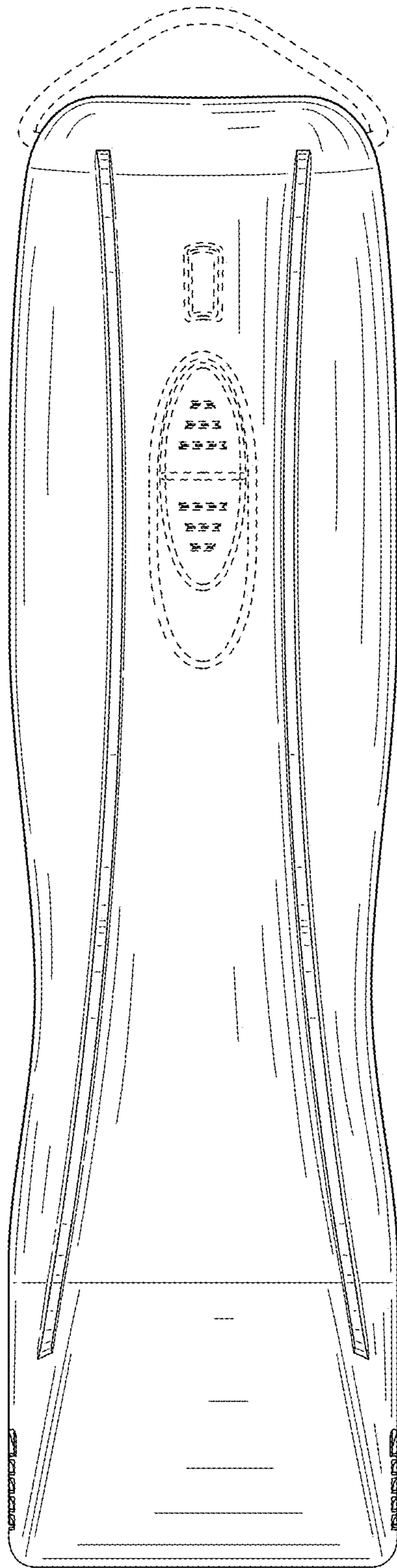

FIG. 11

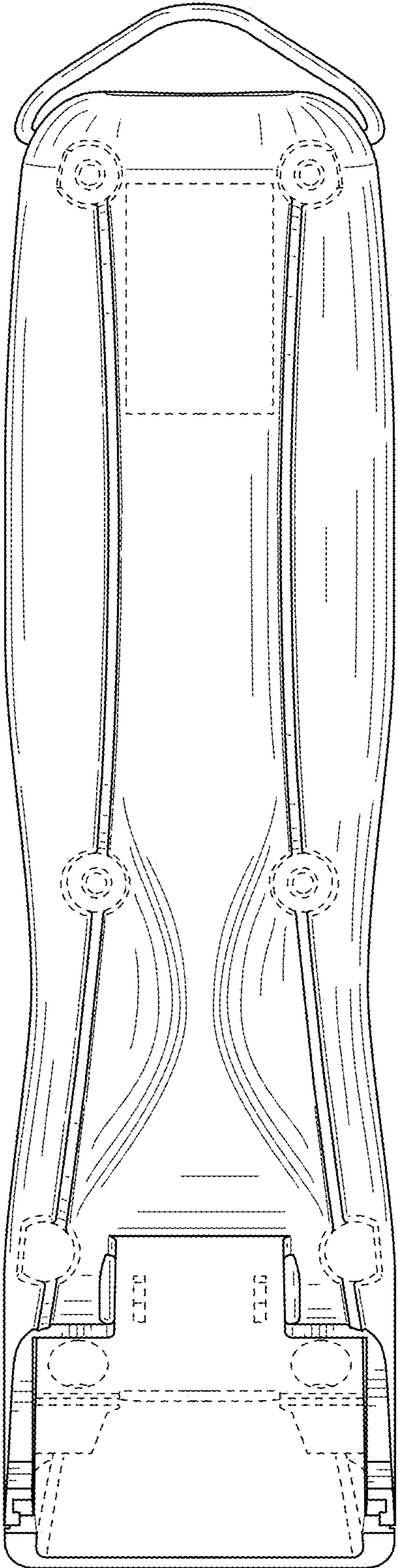

FIG. 12

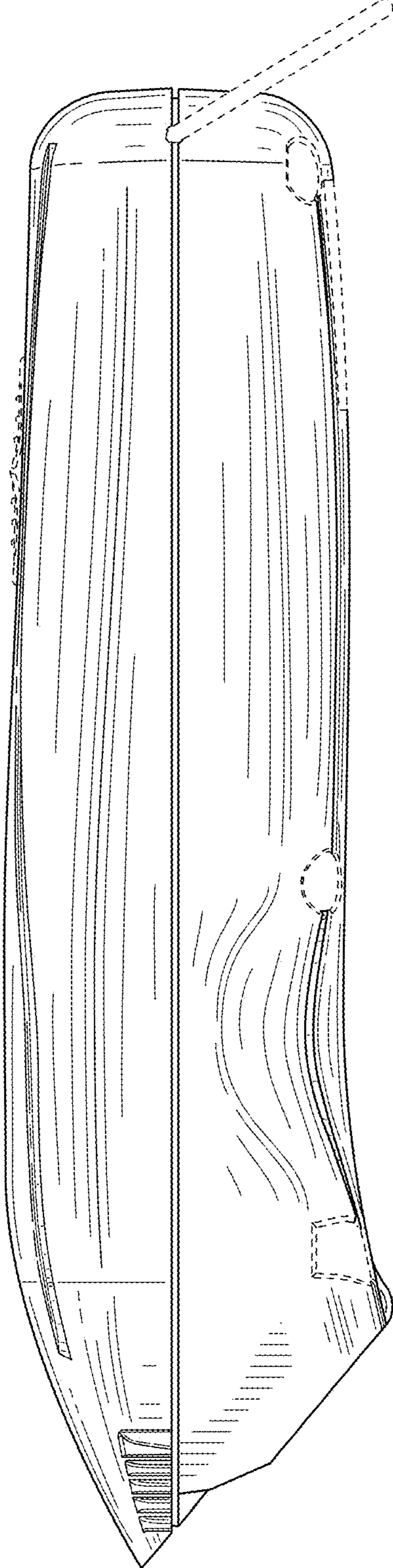

FIG. 13

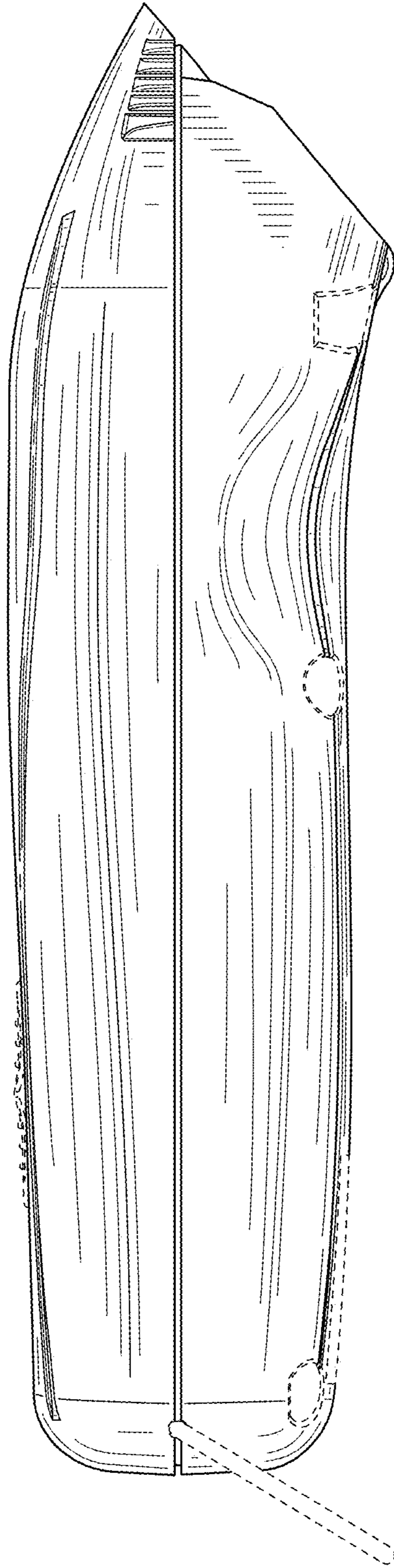

FIG. 14

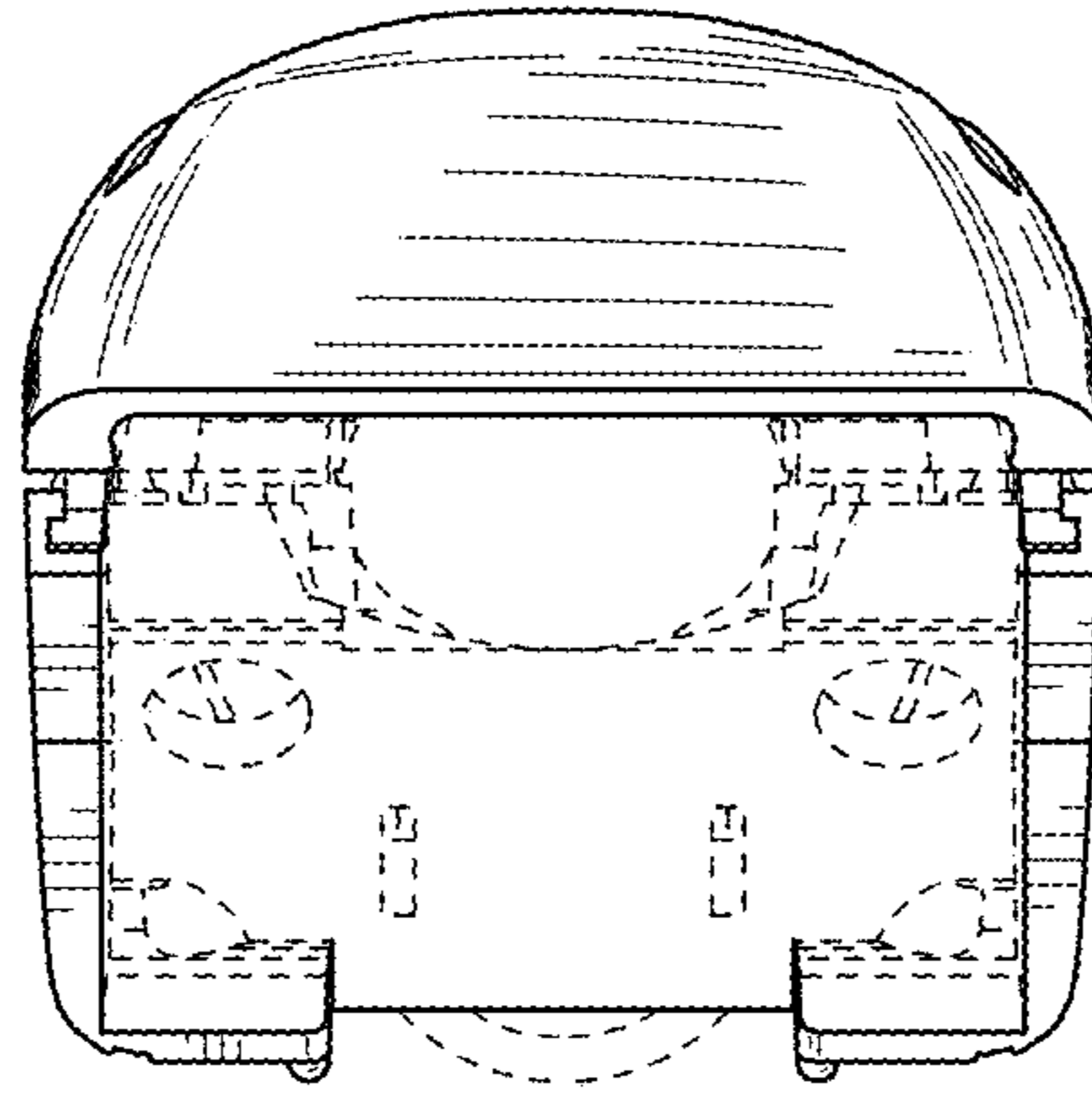

FIG. 15

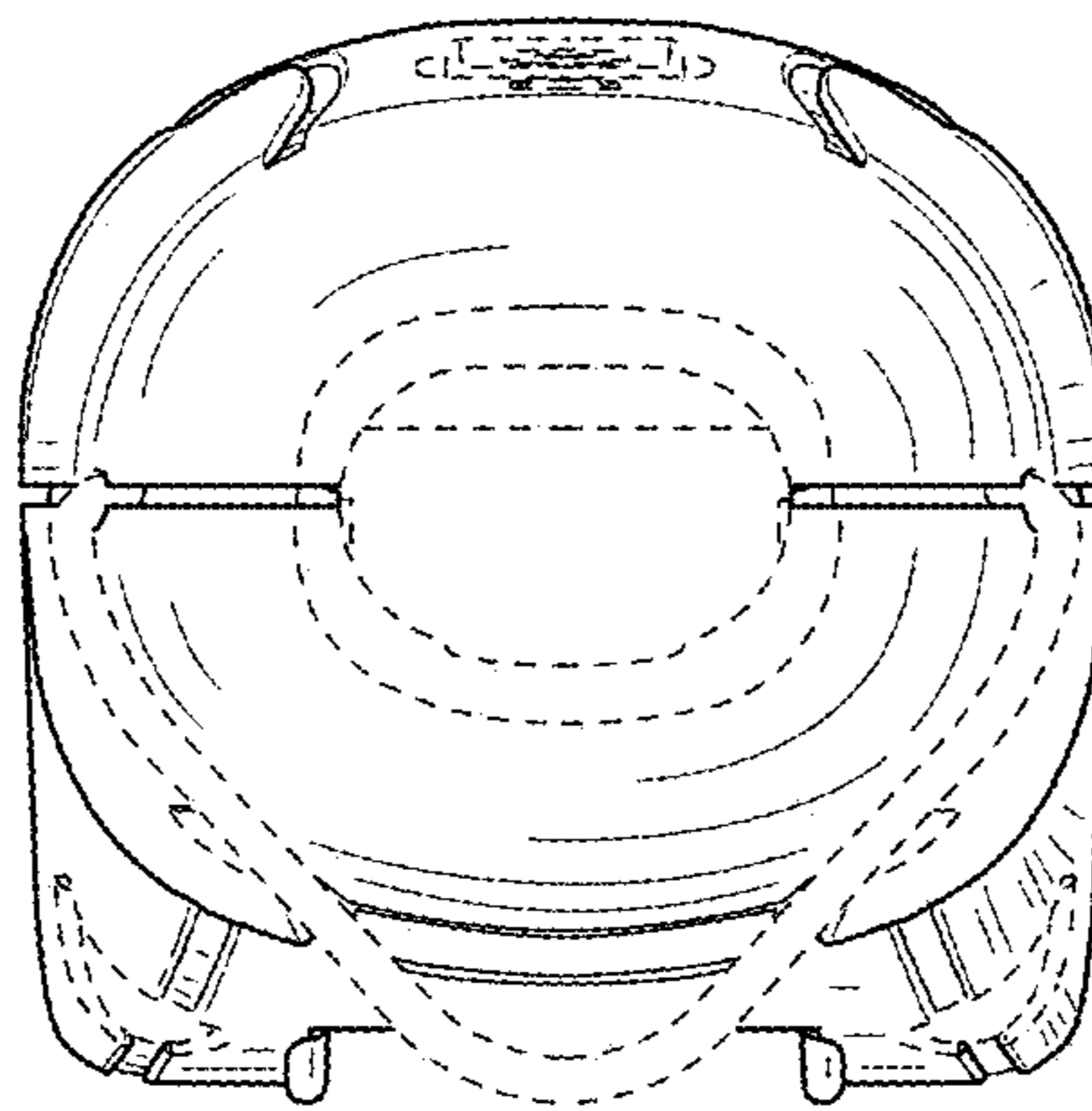

FIG. 16

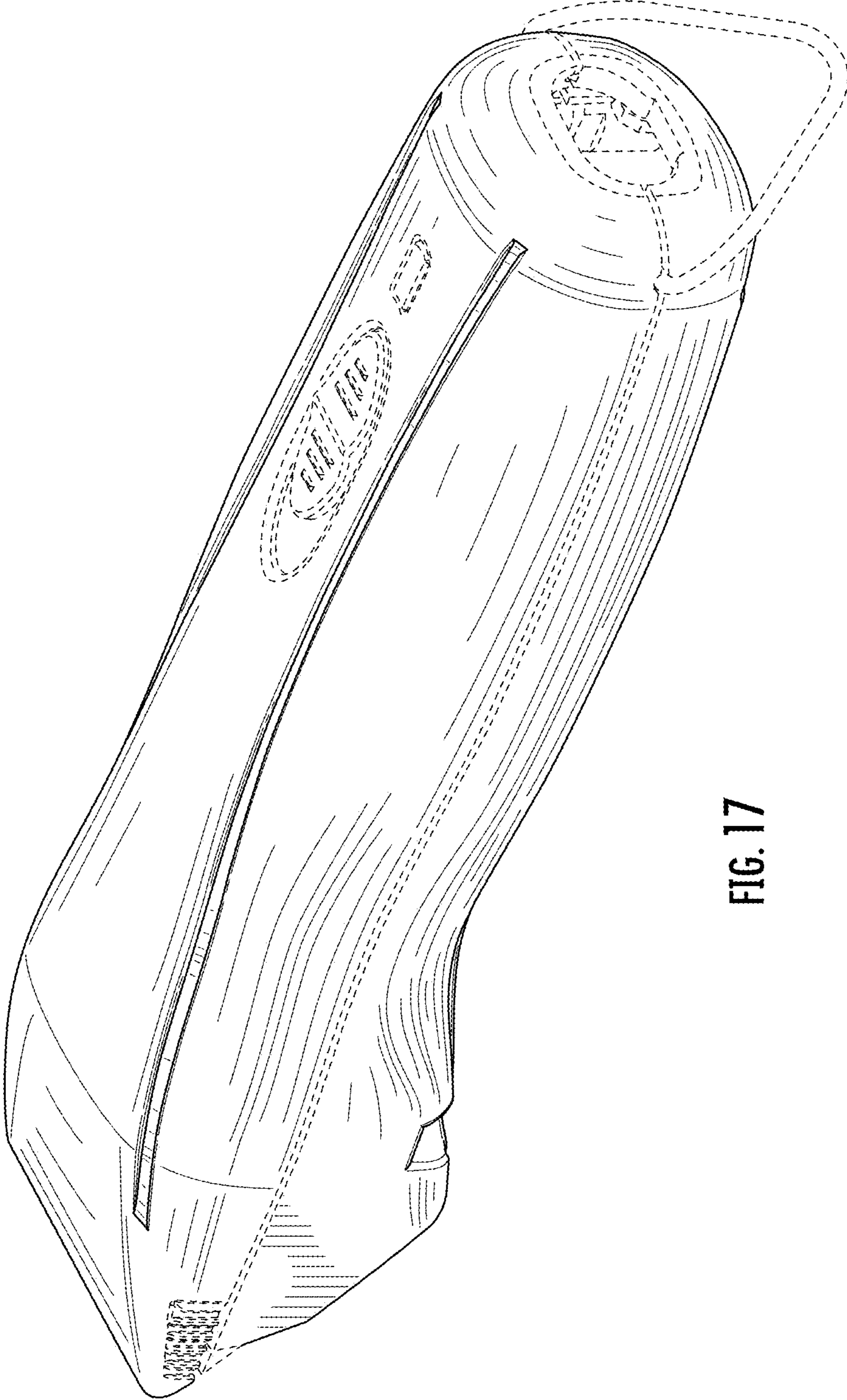

FIG. 17

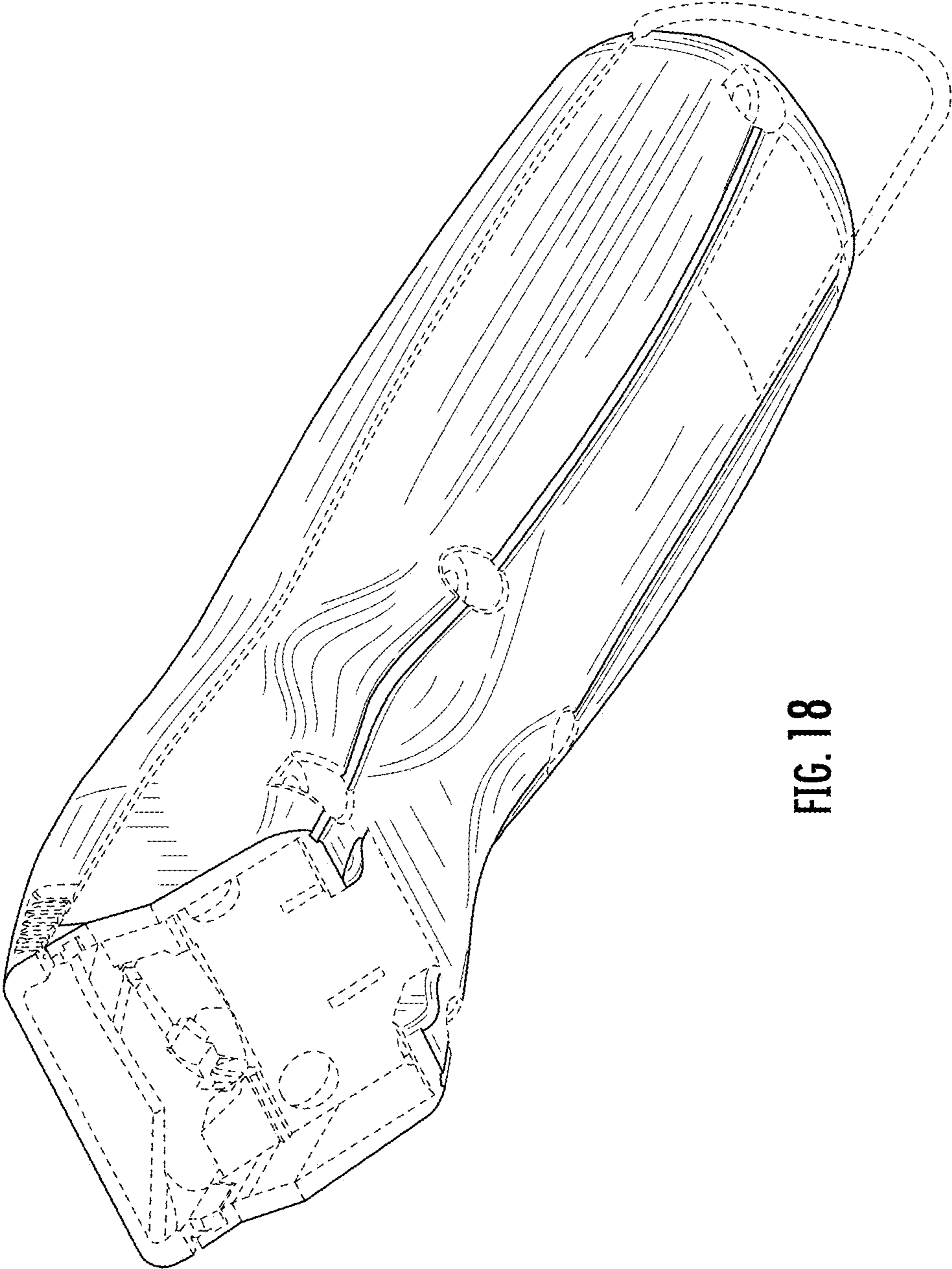

FIG. 18

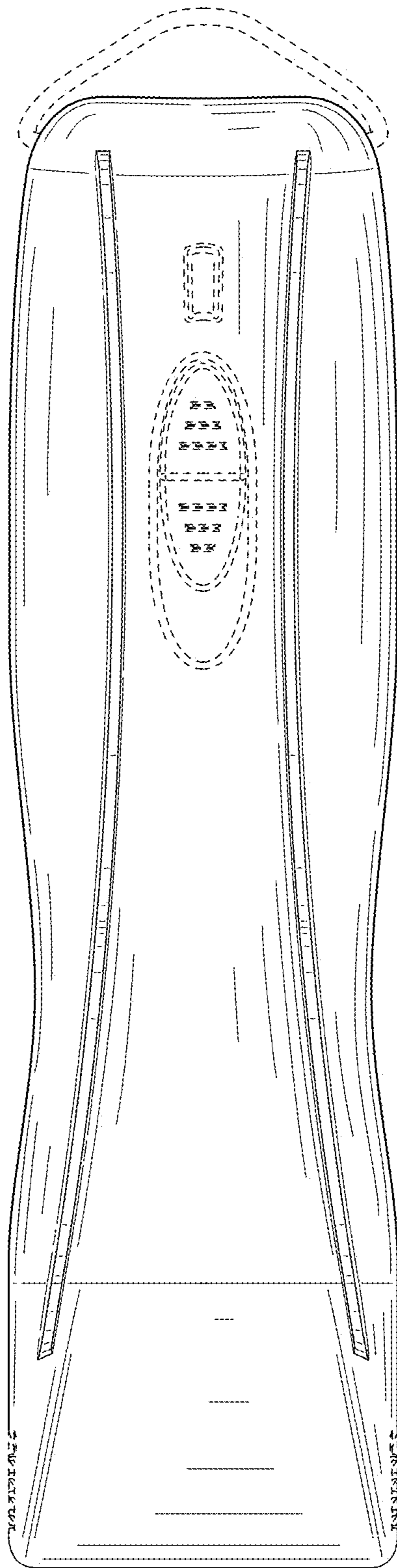

FIG. 19

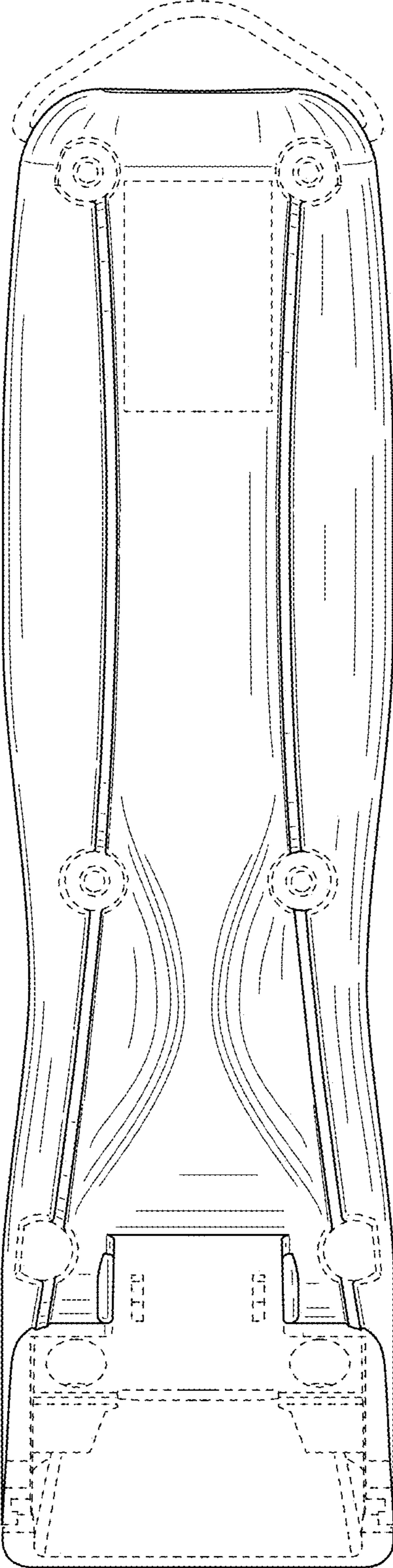

FIG. 20

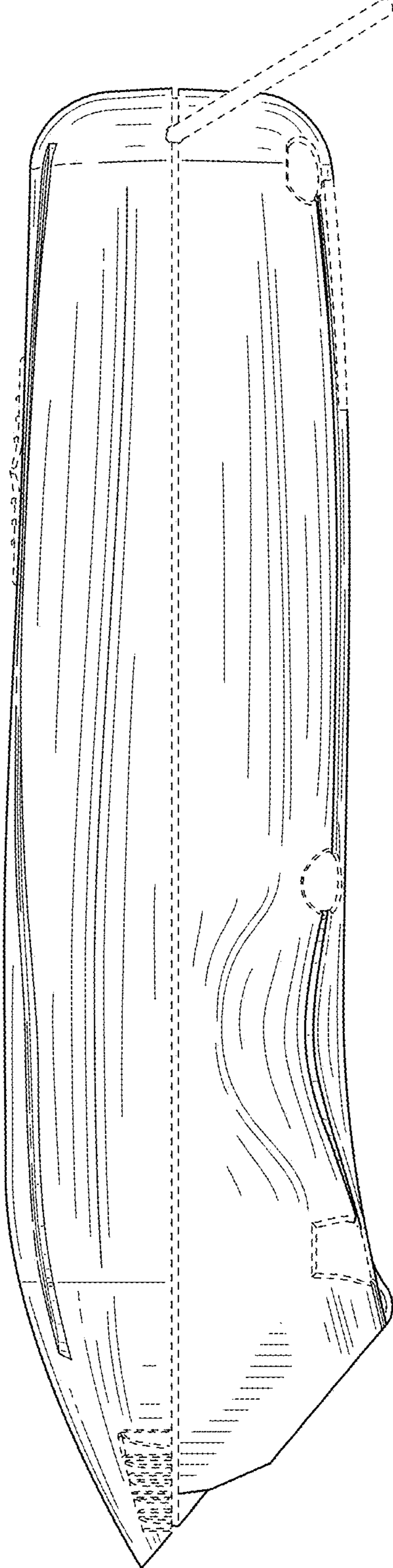

FIG. 21

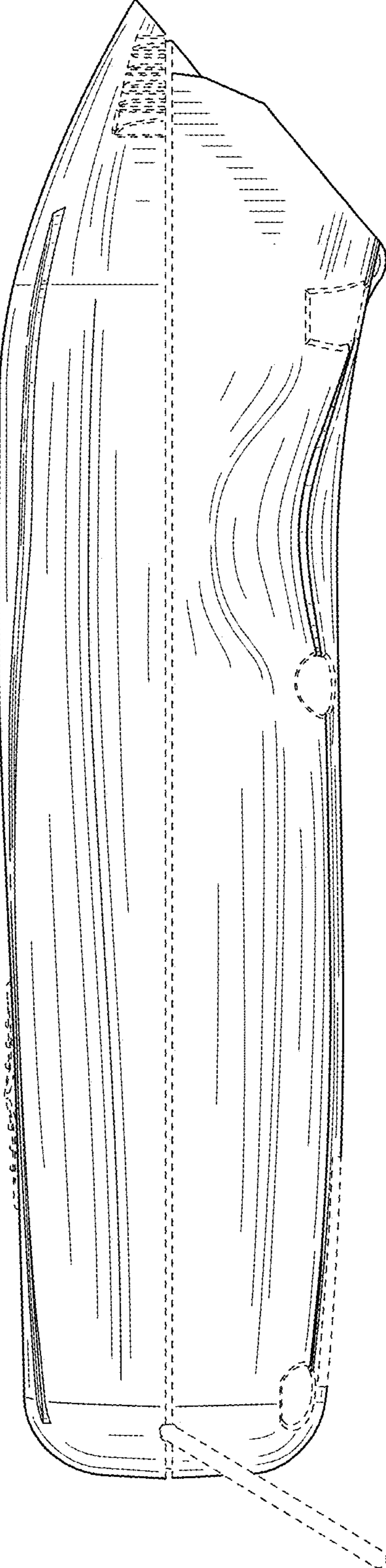

FIG. 22

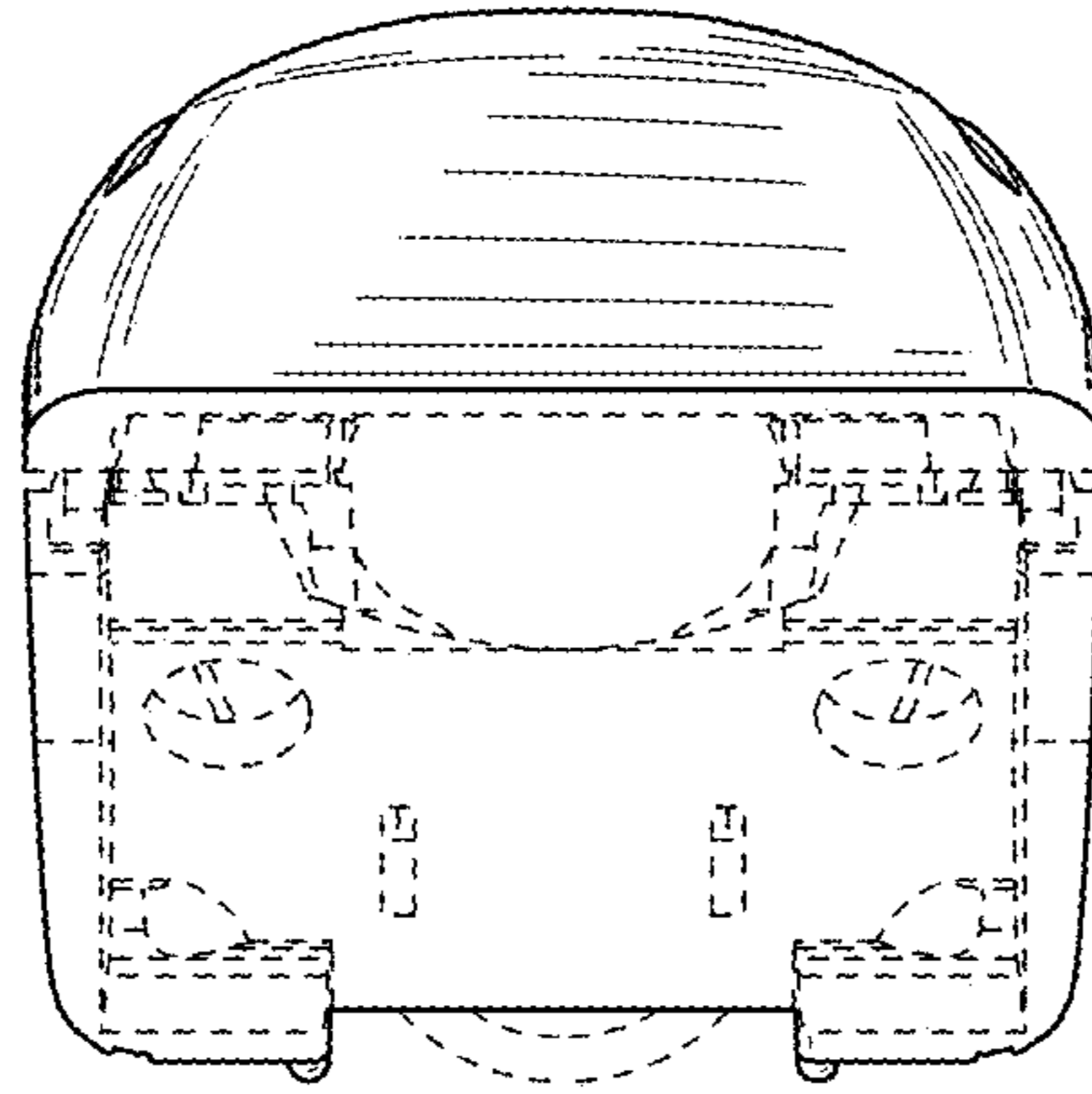

FIG. 23

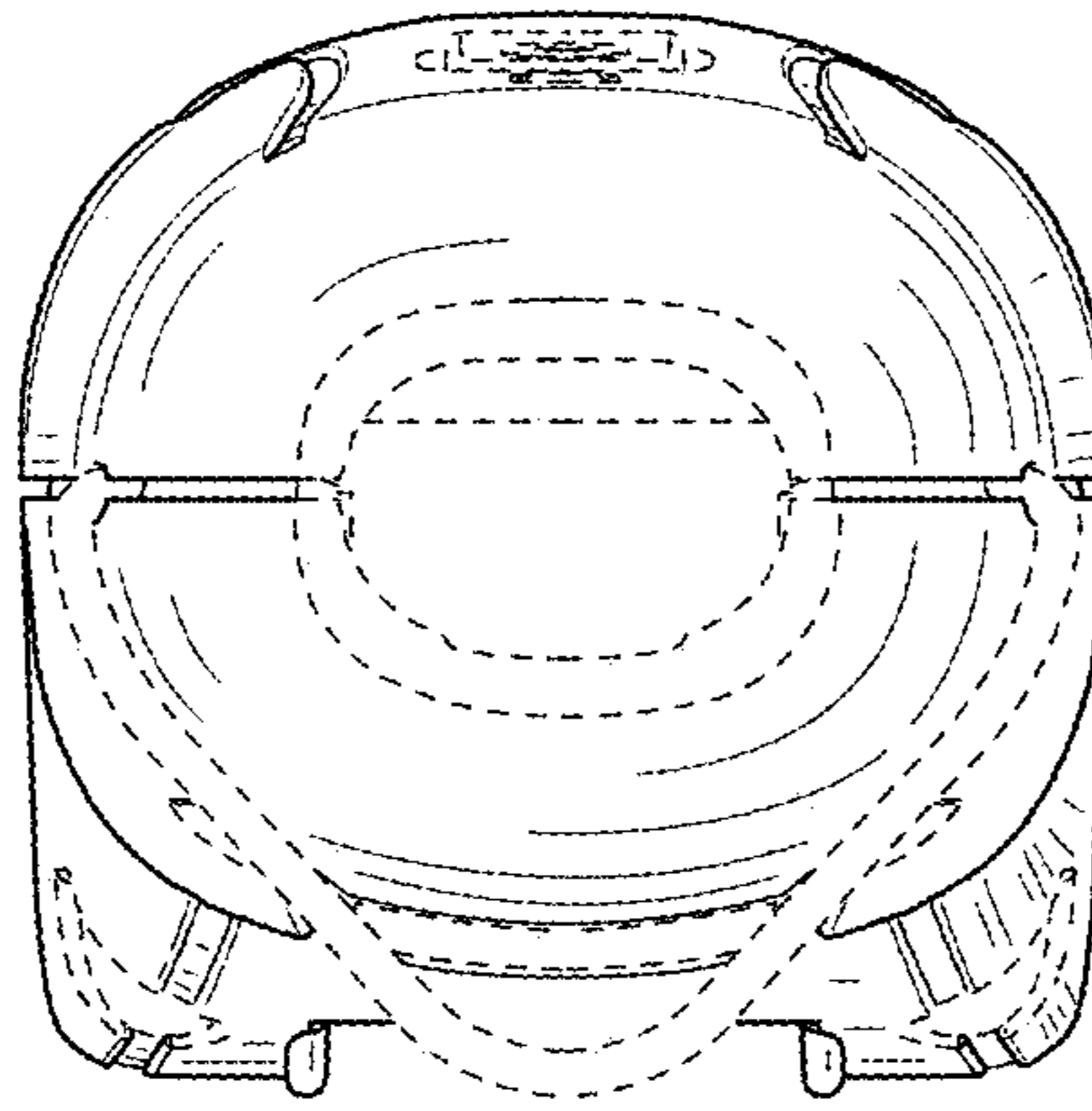

FIG. 24

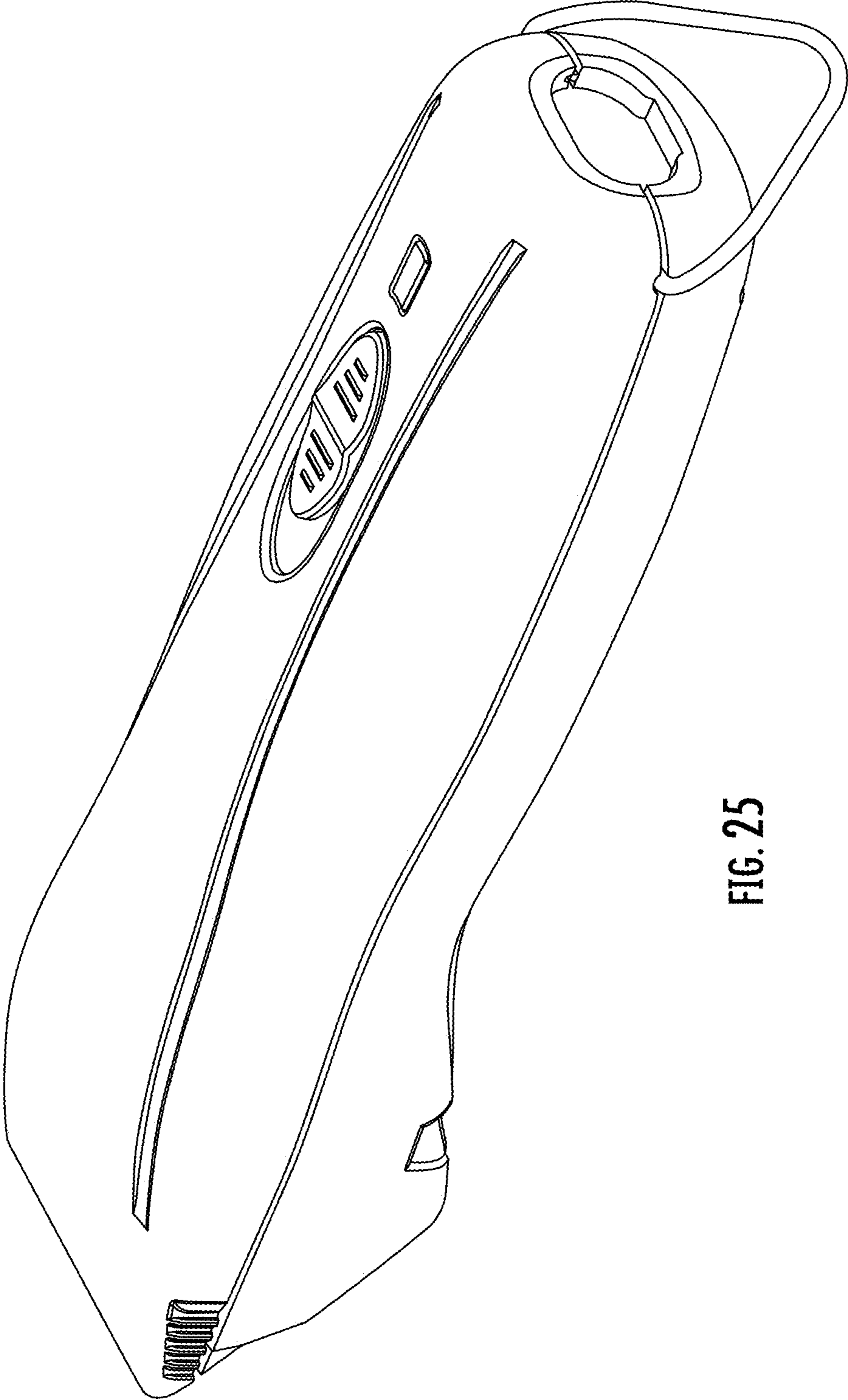

FIG. 25

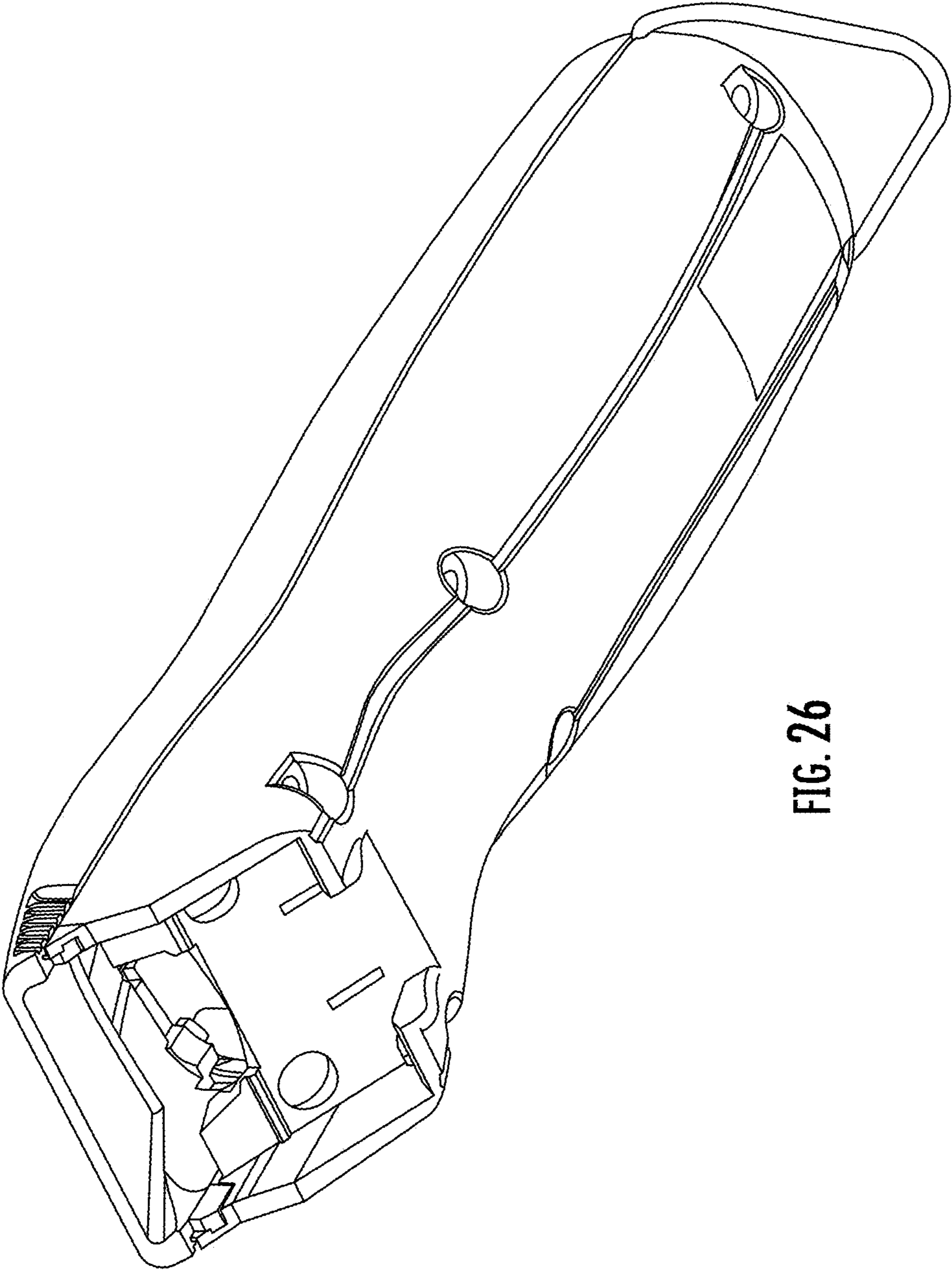

FIG. 26

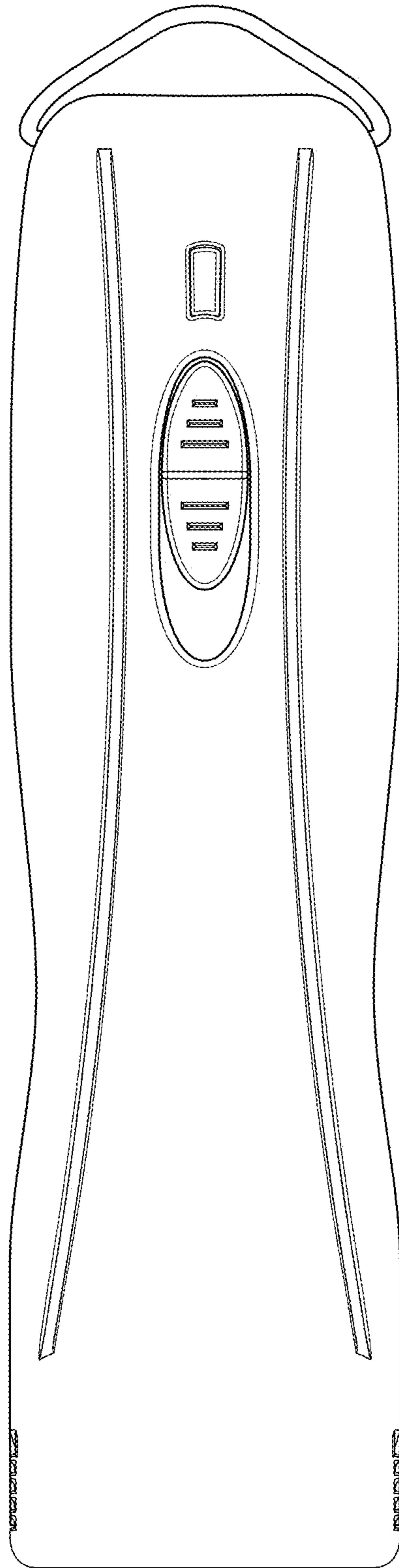

FIG. 27

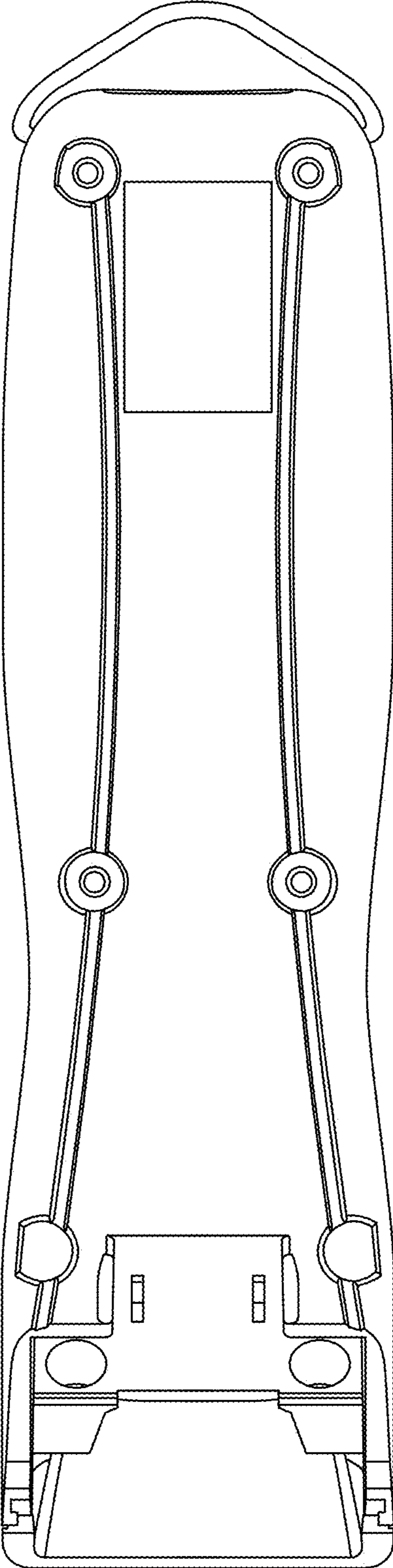

FIG. 28

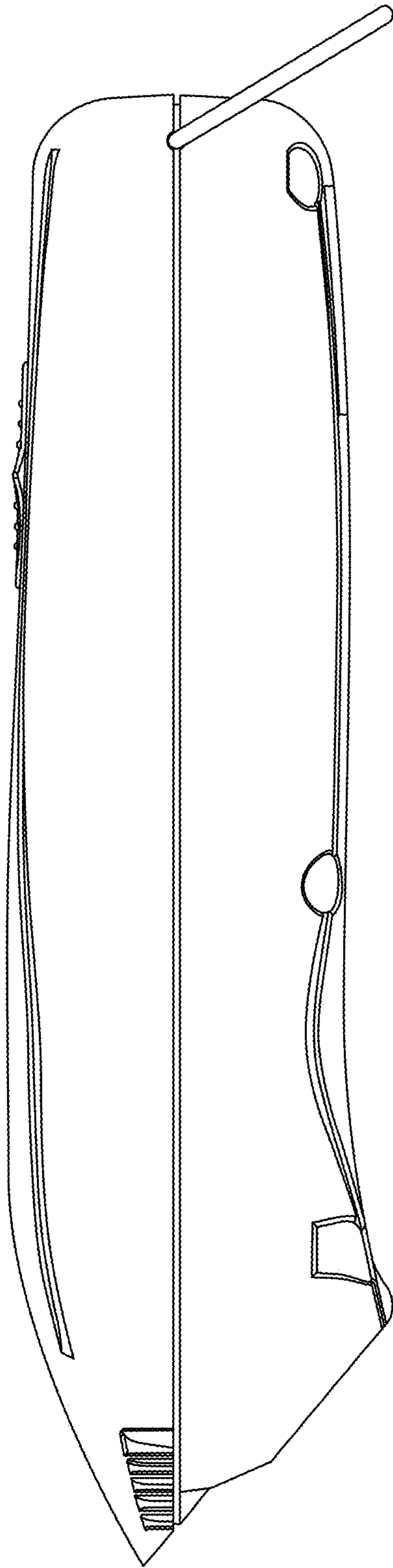

FIG. 29

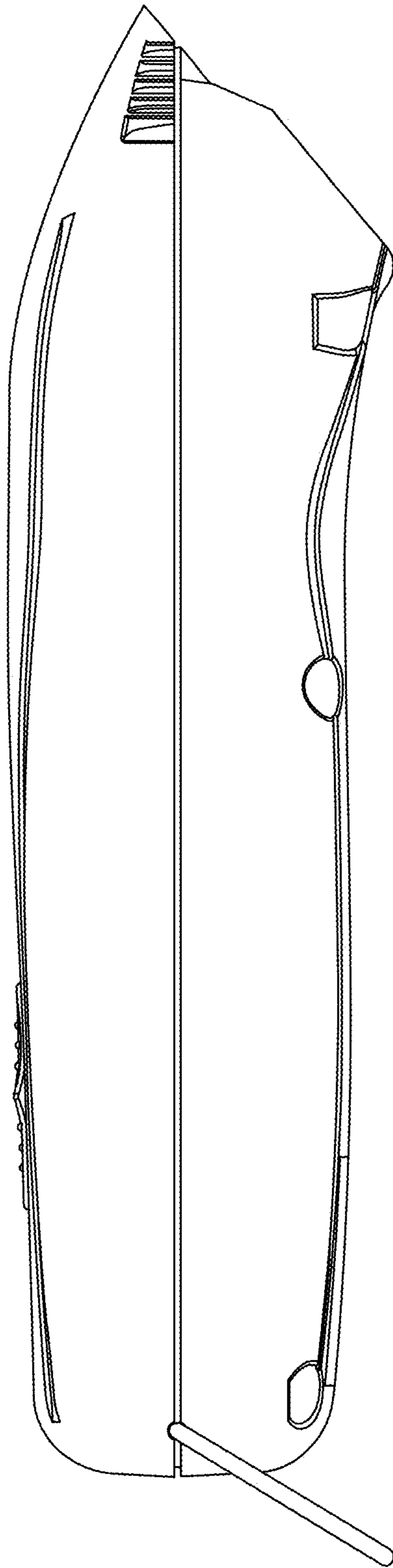

FIG. 30

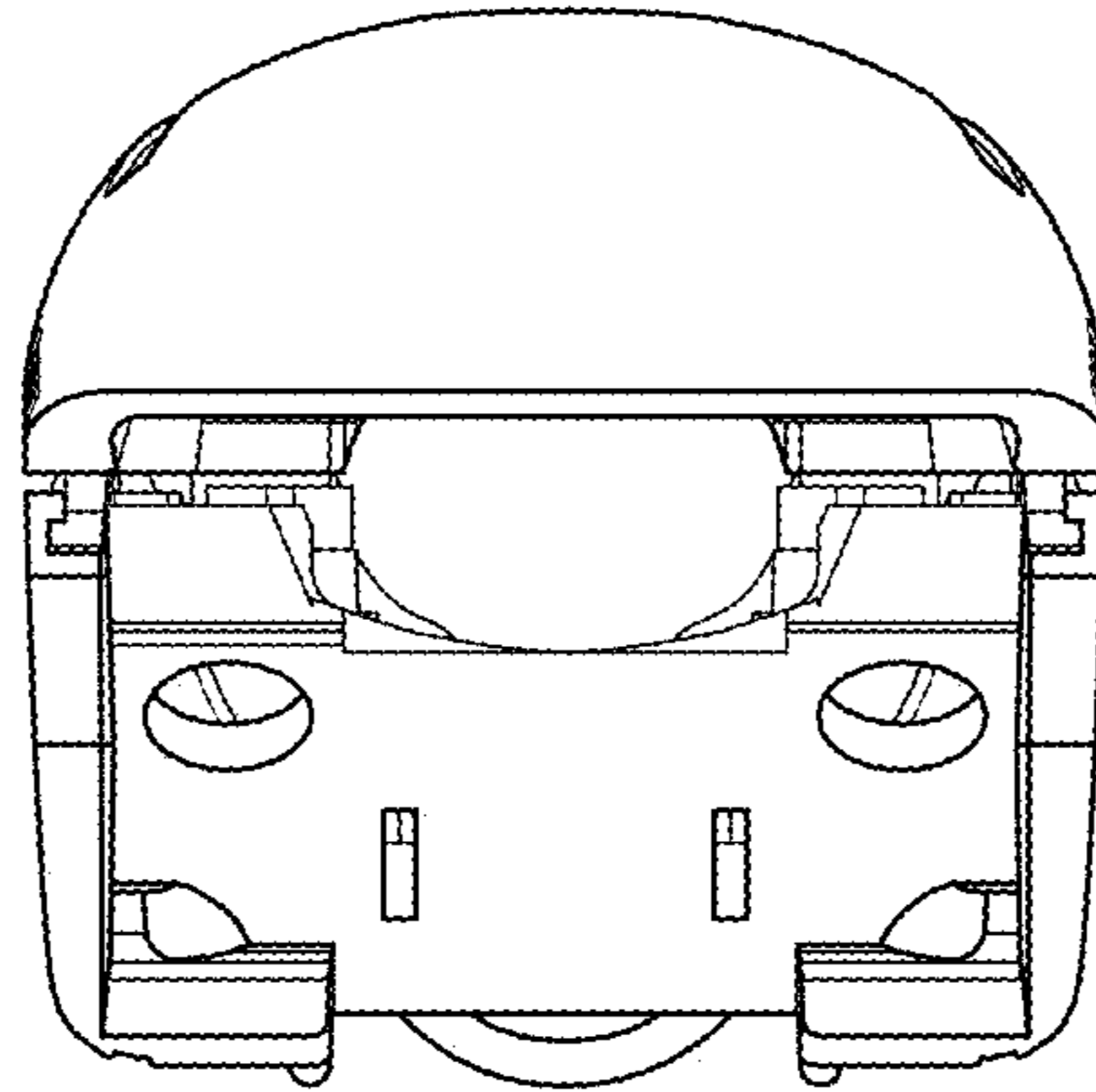

FIG. 31

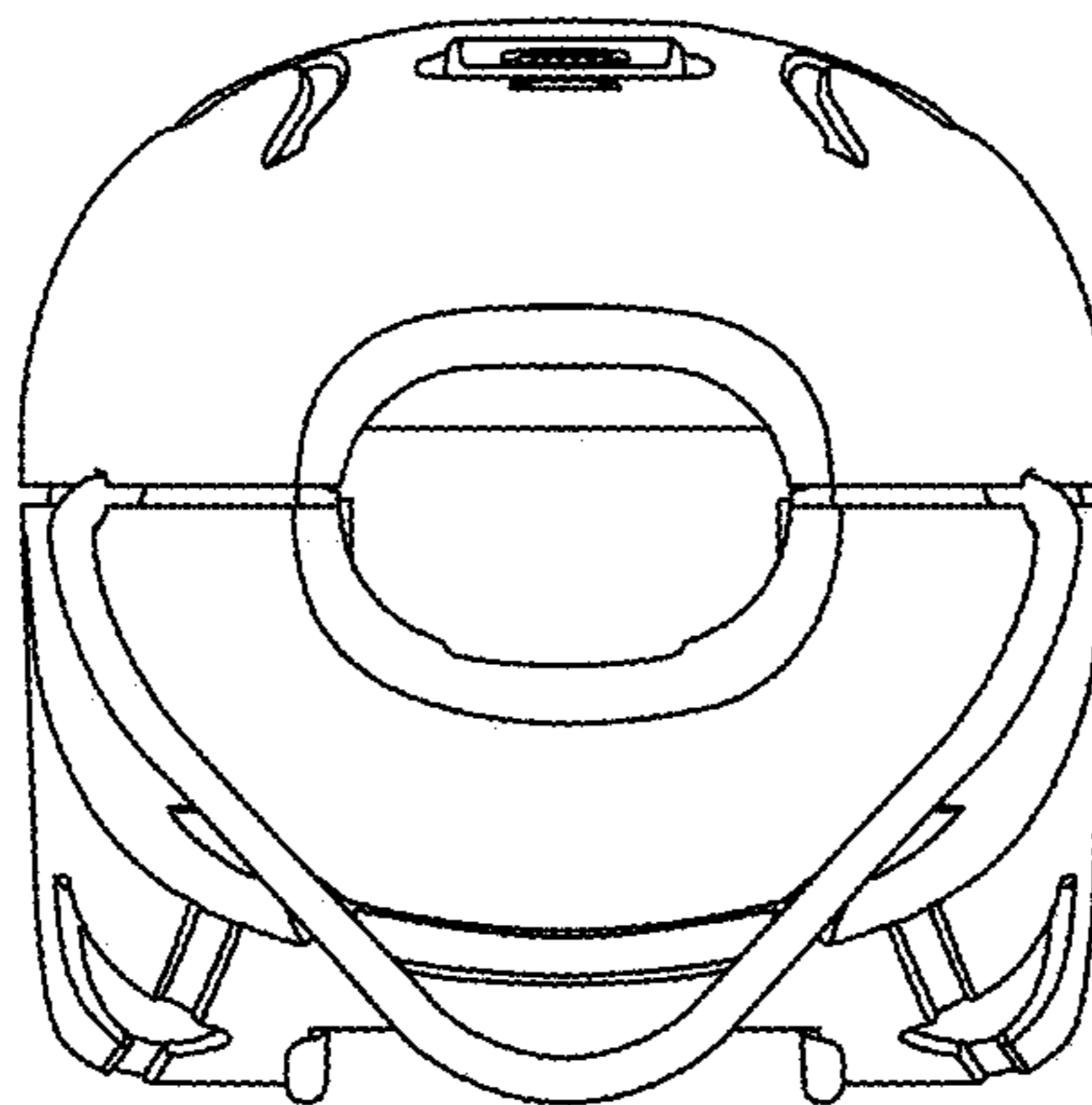

FIG. 32