



US00D943163S

(12) **United States Design Patent**  
**Gibson**

(10) **Patent No.:** **US D943,163 S**

(45) **Date of Patent:** **\*\* Feb. 8, 2022**

- (54) **ELECTRONIC VAPORIZER ASSEMBLY**
- (71) Applicant: **Kandypens Inc**, Santa Barbara, CA (US)
- (72) Inventor: **Graham D Gibson**, Phoenix, AZ (US)
- (73) Assignee: **Kandypens, Inc.**, Santa Barbara, CA (US)

D844,231 S *	3/2019	Klimczyk .....	D27/162
D846,187 S *	4/2019	Hoch .....	D27/162
10,271,579 B2	4/2019	Garay et al.	
D854,740 S *	7/2019	Opp .....	D27/162
10,517,334 B1	12/2019	Volodarsky et al.	
D882,867 S *	4/2020	Volodarsky .....	D27/170
D885,191 S *	5/2020	Thompson .....	D9/544
D885,549 S *	5/2020	Cui .....	D23/366
D895,894 S	9/2020	Bajpai et al.	

- (\*\*) Term: **15 Years**
- (21) Appl. No.: **29/721,310**

- (22) Filed: **Jan. 20, 2020**
- (51) **LOC (13) Cl.** ..... **27-02**
- (52) **U.S. Cl.**  
USPC ..... **D27/162**
- (58) **Field of Classification Search**  
USPC ..... D27/100, 101, 163-165, 172, 180-183,  
D27/185-194; D24/110, 110.5; D9/455,  
D9/456, 544, 549, 558, 574, 548;  
D23/366  
CPC ..... A24F 1/30; A24F 1/00; A24F 1/14; A24F  
1/12; A24F 1/02; F21V 29/506; F21S  
8/00

See application file for complete search history.

(56) **References Cited**

U.S. PATENT DOCUMENTS

D368,325 S *	3/1996	Heine .....	D27/162
D608,879 S *	1/2010	Colombo .....	D23/366
D624,823 S *	10/2010	Brown .....	D9/544
D632,425 S *	2/2011	Badawi .....	D27/162
D649,705 S *	11/2011	Mehio .....	D27/162
D680,684 S *	4/2013	Enshiwat .....	D27/162
D685,646 S *	7/2013	DeMarco .....	D9/558
D686,775 S *	7/2013	Mehio .....	D27/162
D731,705 S *	6/2015	Nadeem .....	D27/162
D754,392 S *	4/2016	Helou .....	D27/162
D755,439 S *	5/2016	Helou .....	D27/162
D780,586 S *	3/2017	Ginders .....	D9/544

OTHER PUBLICATIONS

Hose MYA QT Sky Blue Hookah with Carrying cage and Free Charcoal By: Texas Hookah found on line Feb. 28, 2013 <https://www.amazon.com/Hose-Blue-Hookah-Carrying-Charcoal/dp/B009LO7NMO>.\*

\* cited by examiner

*Primary Examiner* — Rebecca Tsehaye

(74) *Attorney, Agent, or Firm* — KW Law, LLP

(57) **CLAIM**

The ornamental design of an electronic vaporizer assembly, substantially as shown and described.

**DESCRIPTION**

FIG. 1 is a top front perspective view of an electronic vaporizer assembly comprising a base and a glass mouth-piece portion in accordance with the present design; FIG. 2 is a left side view thereof; FIG. 3 is a right side view thereof; FIG. 4 is a front view thereof; FIG. 5 is a back view thereof; FIG. 6 is a top view thereof; and, FIG. 7 is a bottom view thereof.

The broken lines in the Figures show portions of the electronic vaporizer assembly which form no part of the claimed design. The oblique lines in the drawings indicate transparency.

**1 Claim, 7 Drawing Sheets**

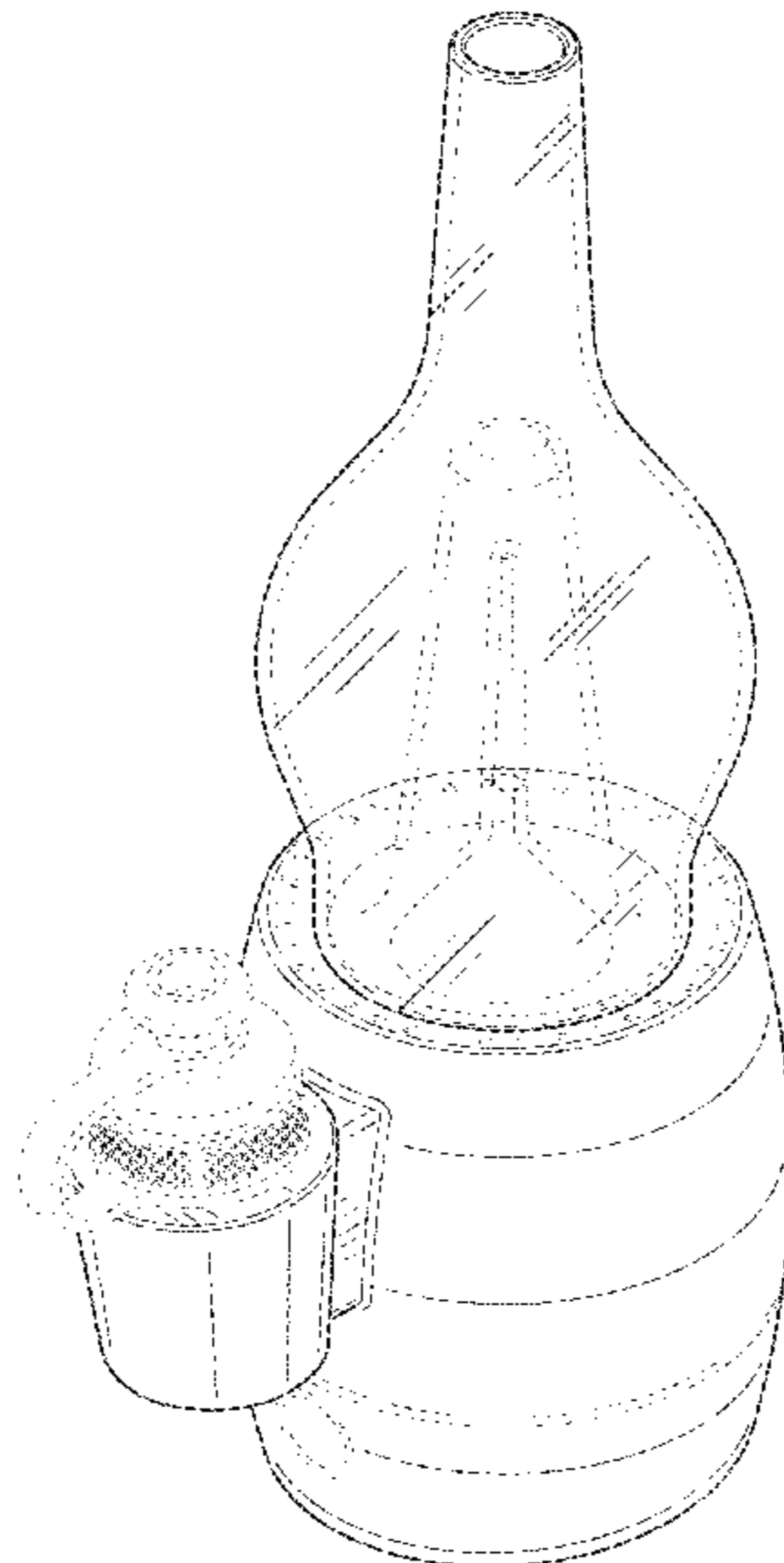

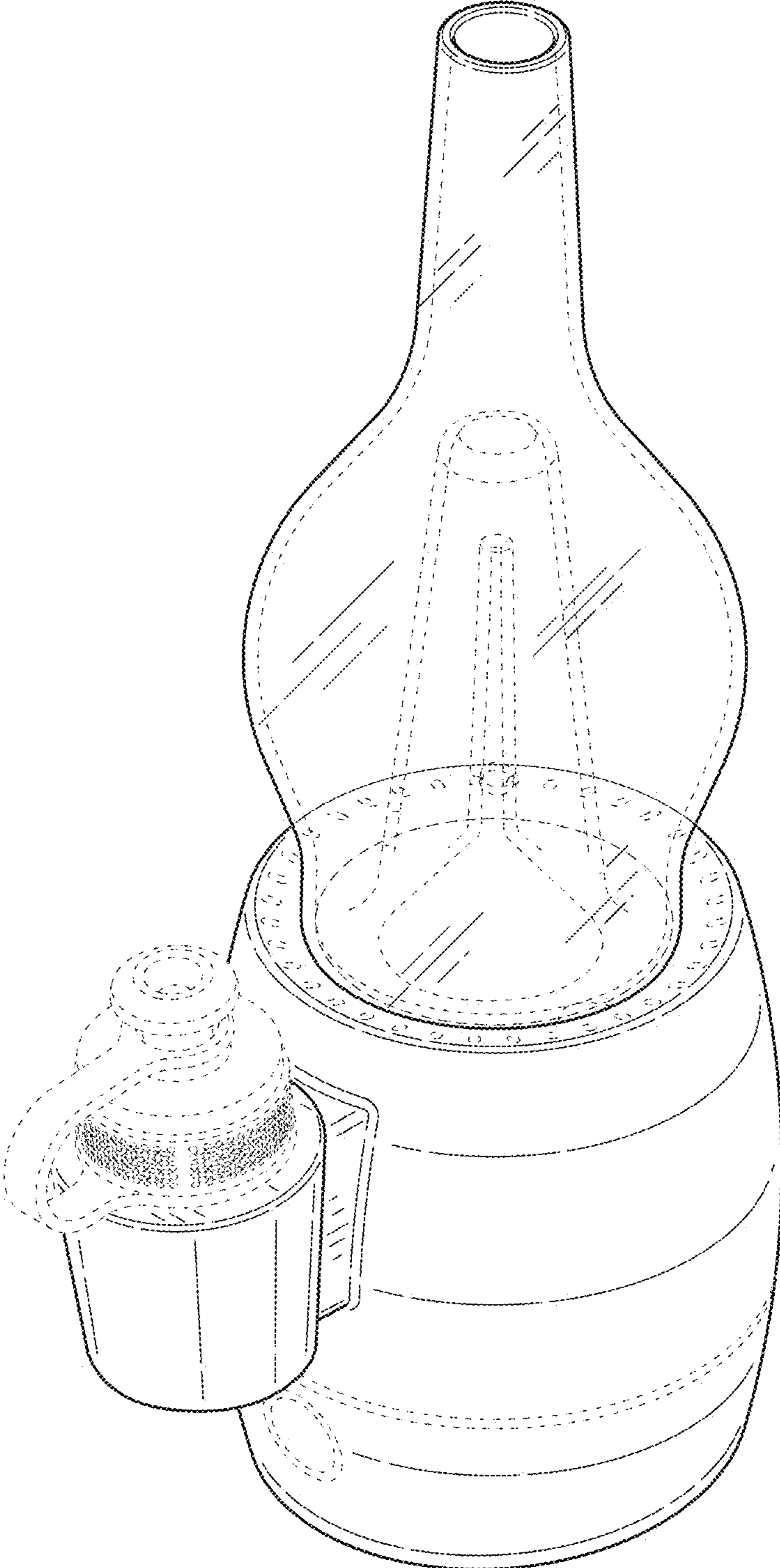

FIG. 1

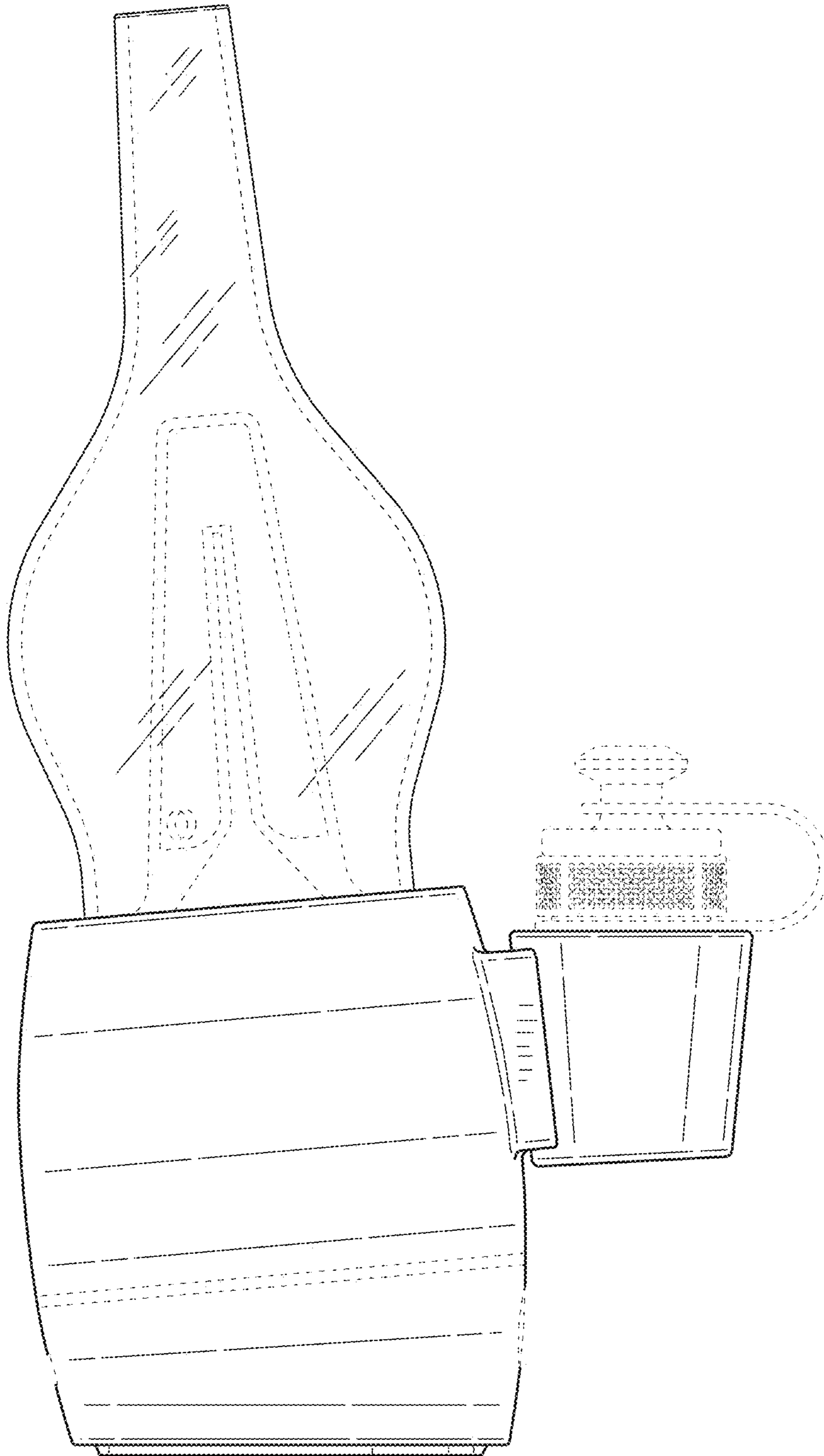

FIG.2

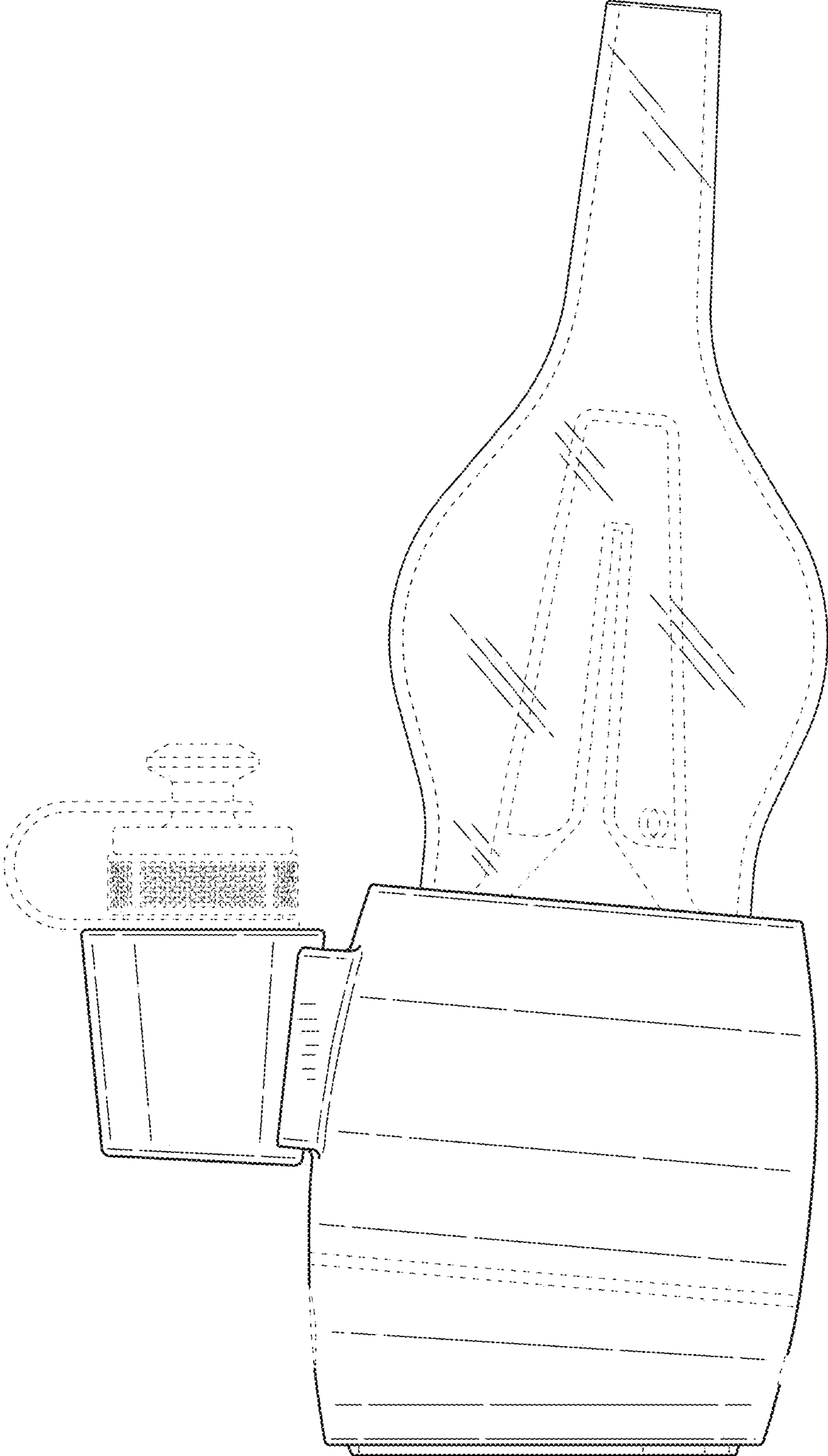

FIG.3

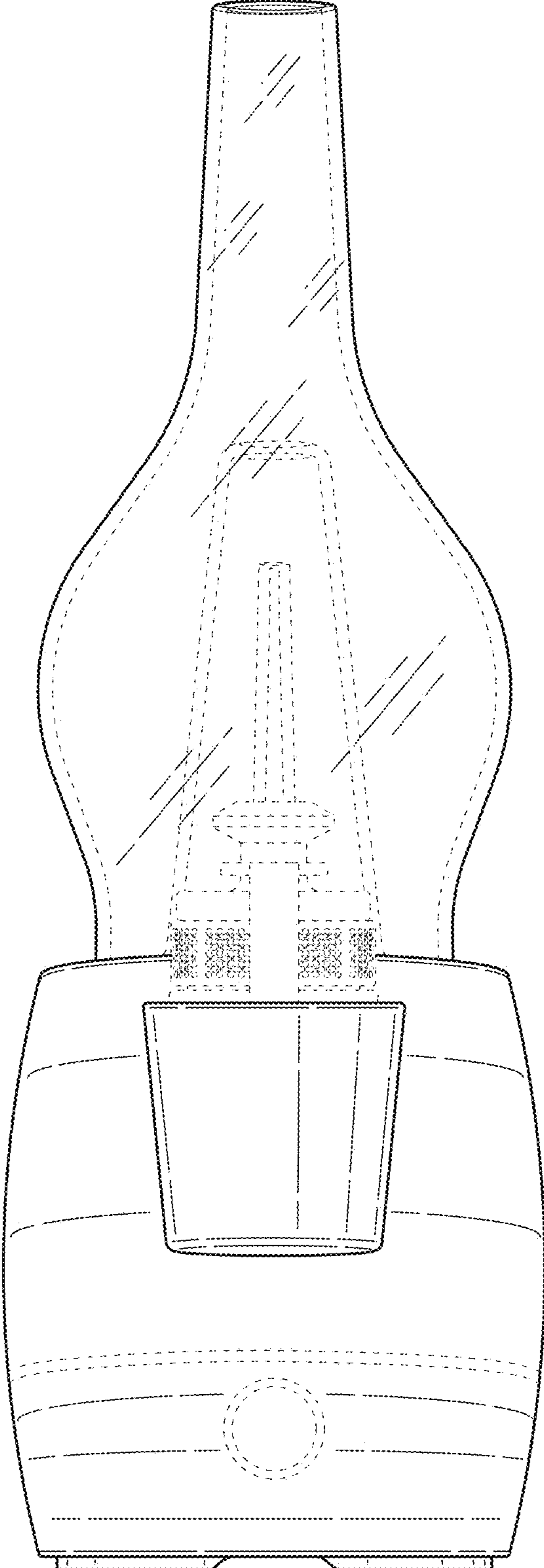

FIG.4

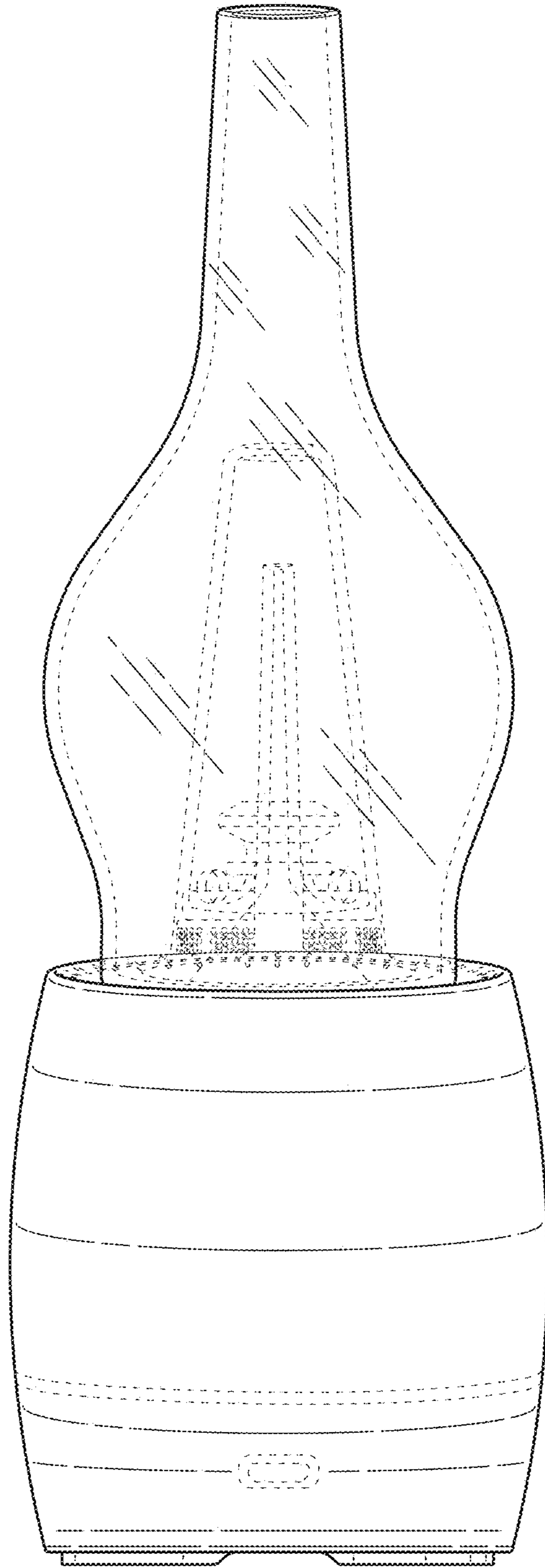

FIG. 5

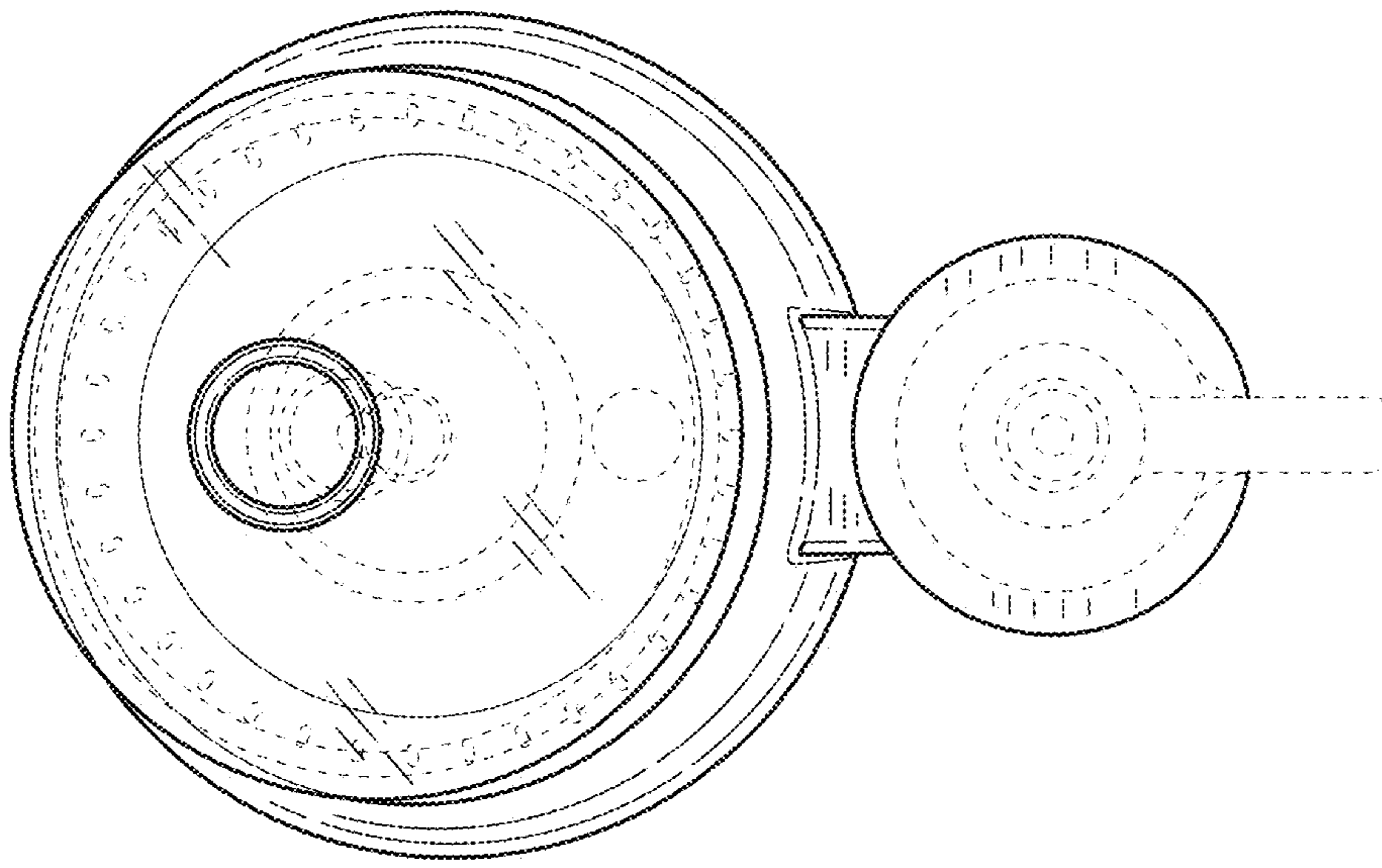

FIG.6

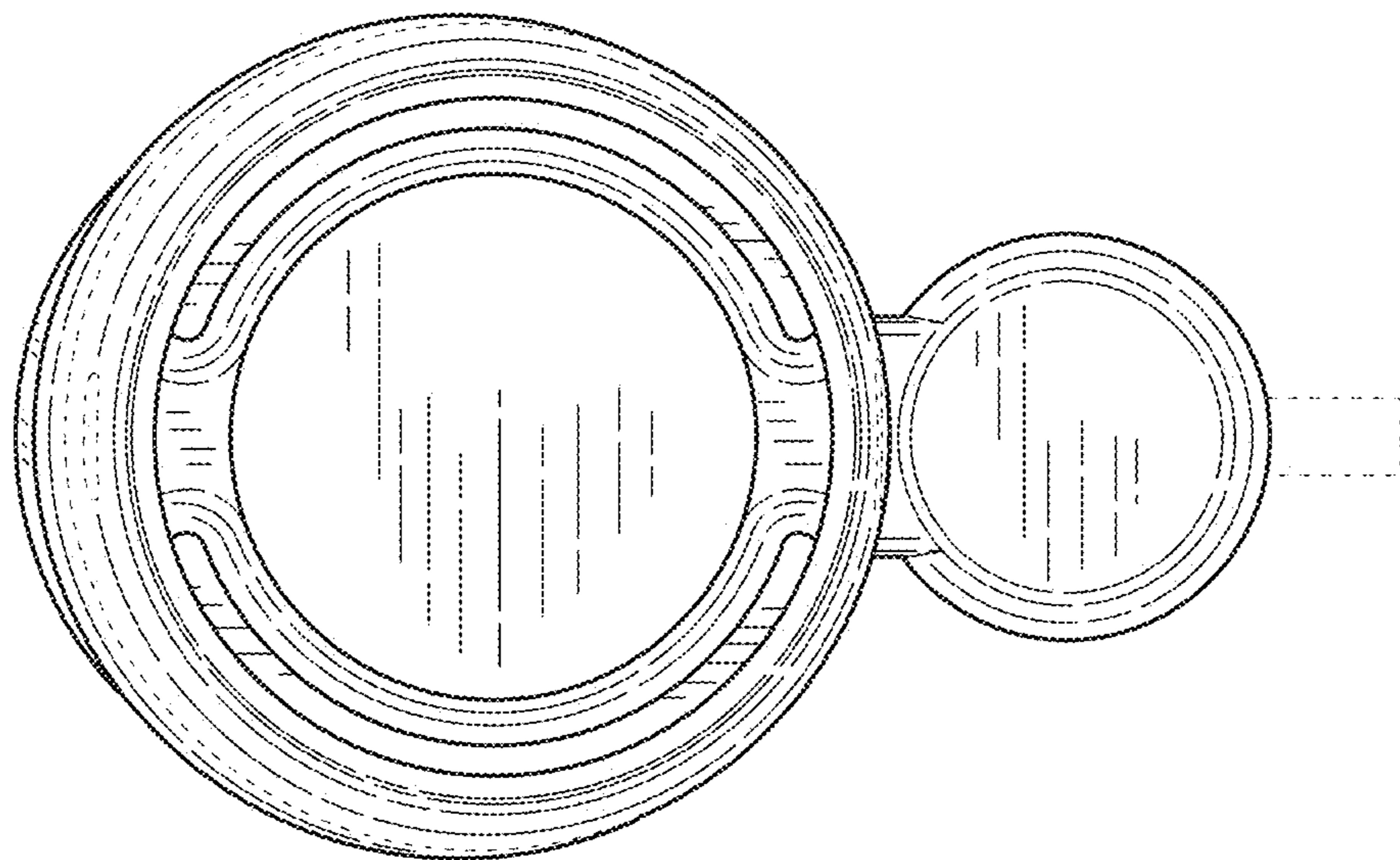

FIG.7