



US00D943109S

(12) **United States Design Patent** (10) **Patent No.:** **US D943,109 S**
Thuma et al. (45) **Date of Patent:** **** Feb. 8, 2022**

(54) **SHED**
(71) Applicant: **Suncast Technologies, LLC**, Palm Beach Gardens, FL (US)
(72) Inventors: **Michael Thuma**, La Grange, FL (US); **Torrence Anderson**, Overland Park, KS (US); **Stephen Whitehead**, Elgin, IL (US)

D688,806 S * 8/2013 Phillips D25/33
8,511,001 B2 * 8/2013 Uffner E04B 1/34321
52/66
D728,824 S * 5/2015 McKimmy D25/33
D730,541 S * 5/2015 Phillips D25/33
D767,921 S * 10/2016 Burden D6/671.1
D769,032 S * 10/2016 Burden D6/671.1
D784,557 S * 4/2017 Thuma D25/33

(Continued)

FOREIGN PATENT DOCUMENTS

(73) Assignee: **Suncast Technologies, LLC**, Palm Beach Gardens, FL (US)
(**) Term: **15 Years**

GB 2007355 * 6/1990
GB 6016389 * 8/2017
JP D1082806 * 8/2000

OTHER PUBLICATIONS

(21) Appl. No.: **29/673,713**
(22) Filed: **Dec. 17, 2018**
(51) **LOC (13) Cl.** **25-03**
(52) **U.S. Cl.**
USPC **D25/33; D6/671.1**
(58) **Field of Classification Search**
USPC D25/48.2, 48.3, 33, 16, 59, 22, 15, 17,
D25/18, 29, 32, 30, 34; D6/663, 667,
D6/671.1; D34/7, 8, 11, 1; D30/108;
D3/273, 294
CPC E04H 6/005; E04H 1/12; E04H 1/1216;
E04H 1/1205; E04B 1/34321; E04B
2001/34389
See application file for complete search history.

Starplast, Plastic Mocha/Brown Storage Cabinet, Feb. 13, 2018, Home Depot, <https://www.homedepot.com/p/Starplast-2-ft-5-in-x-1-ft-8-in-x-5-ft-11-in-Plastic-Mocha-Brown-Storage-Cabinet-w-4-Shelves-and-Vertical-Partition-FG000852/303723212> (Year: 2018).*

Primary Examiner — Brett Miller
(74) *Attorney, Agent, or Firm* — McHale & Slavin, P.A.

(57) **CLAIM**

The ornamental design for a shed, as shown and described.

DESCRIPTION

FIG. 1 is a top front left perspective view of the shed of the present invention;
FIG. 2 is a top right perspective view thereof;
FIG. 3 is a front view thereof;
FIG. 4 is a rear view thereof;
FIG. 5 is a left side view thereof;
FIG. 6 is a right side view thereof; and,
FIG. 7 is a top view thereof.
The portions of the shed illustrated in broken lines are for illustrative purposes only and form no part of the claimed design.

(56) **References Cited**
U.S. PATENT DOCUMENTS

D332,332 S * 1/1993 Markey D34/1
D365,154 S * 12/1995 Maple D25/16
D375,169 S * 10/1996 Hunt D25/16
D384,419 S * 9/1997 Dickinson D25/16
D468,442 S * 1/2003 Tisbo D25/16
D468,833 S * 1/2003 Tisbo D25/33
D559,011 S * 1/2008 Mehmen D6/671.1
D591,076 S * 4/2009 Guizzardi D6/671.1
D625,835 S * 10/2010 McKimmy D25/33

1 Claim, 7 Drawing Sheets

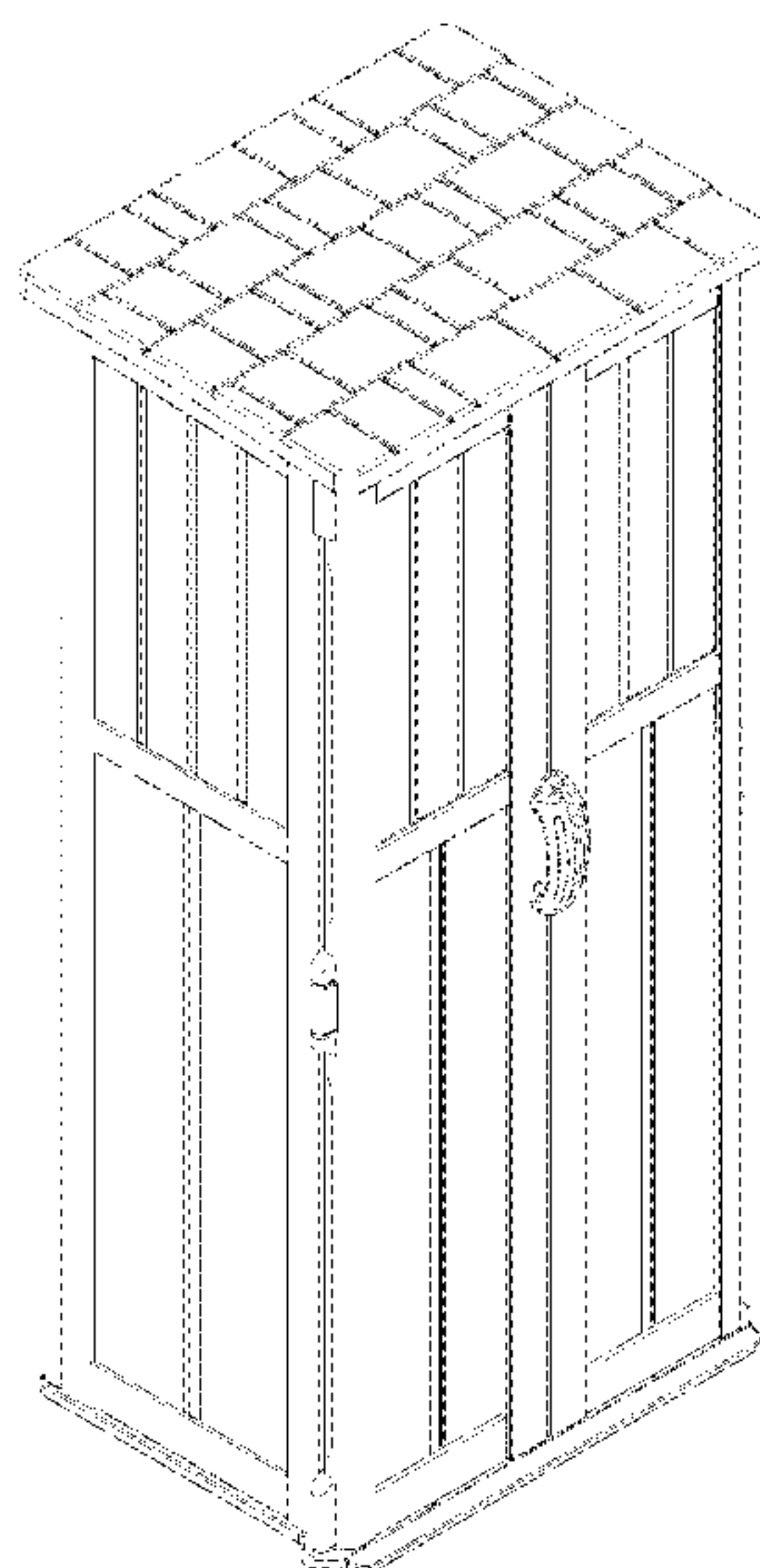

(56)

References Cited

U.S. PATENT DOCUMENTS

D870,495 S	*	12/2019	Guo	D6/671
D914,401 S	*	3/2021	Leng	D6/667
D914,402 S	*	3/2021	Xiao	D6/667
D919,970 S	*	5/2021	Kim	D3/294

* cited by examiner

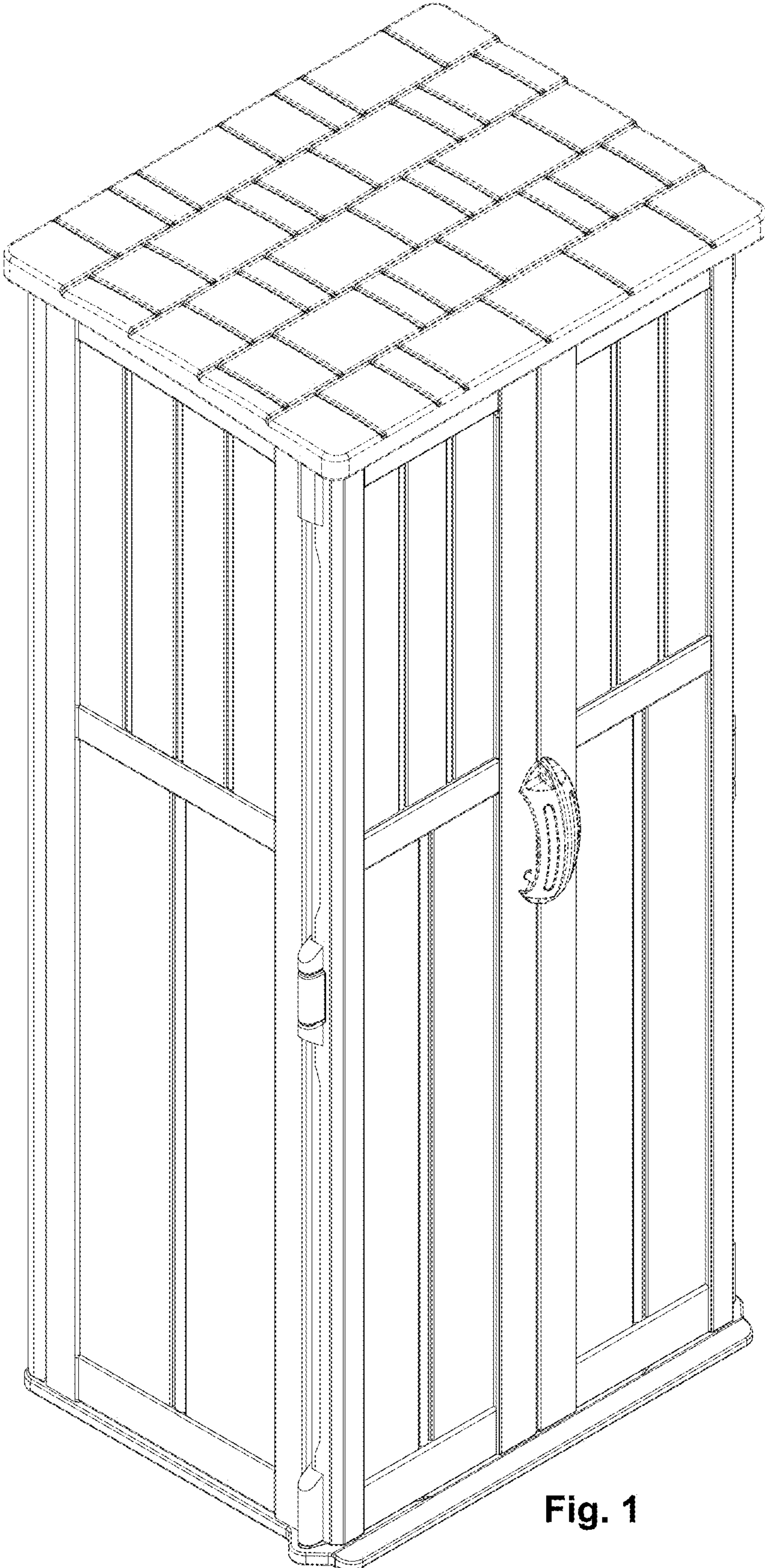

Fig. 1

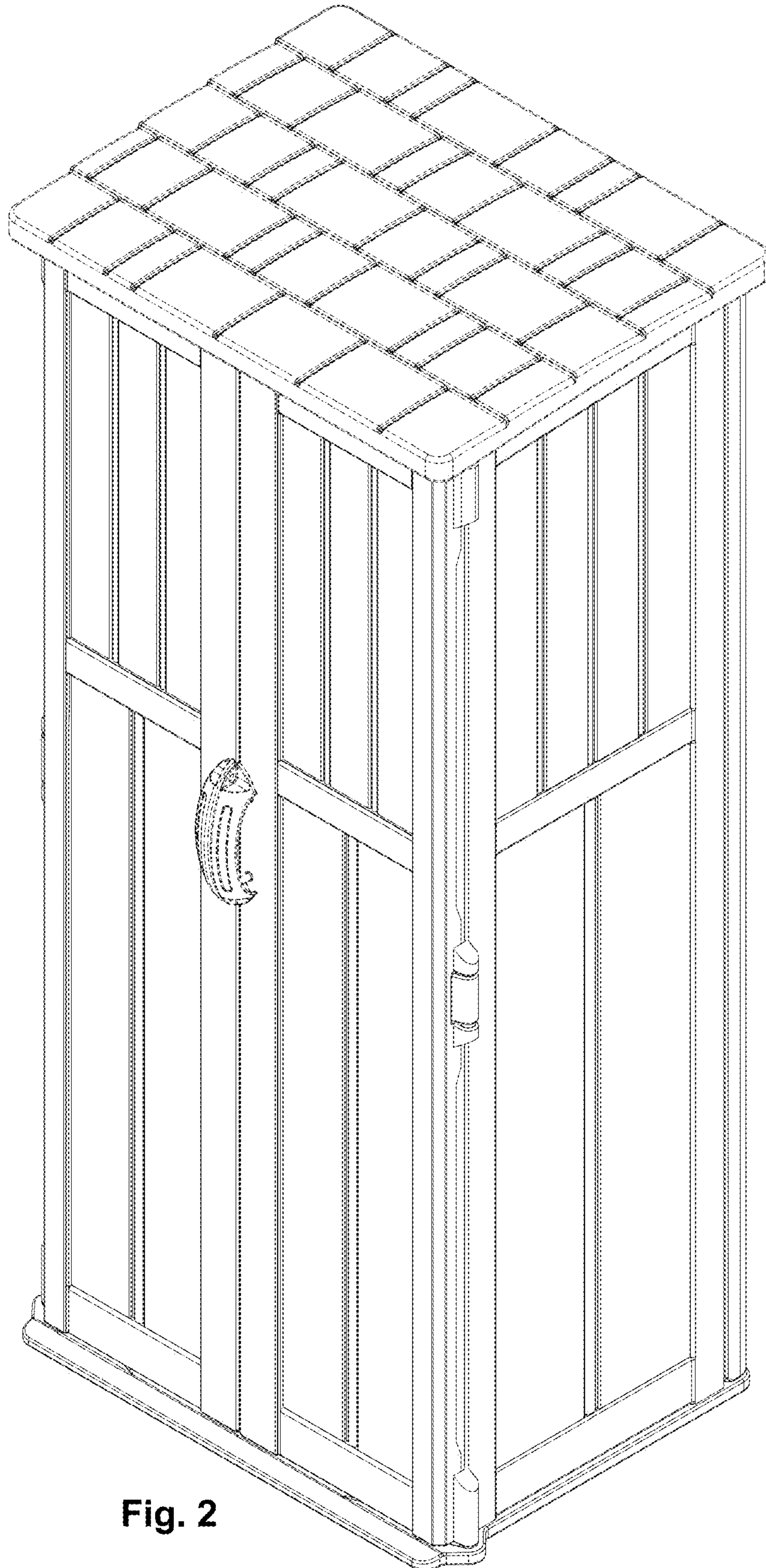

Fig. 2

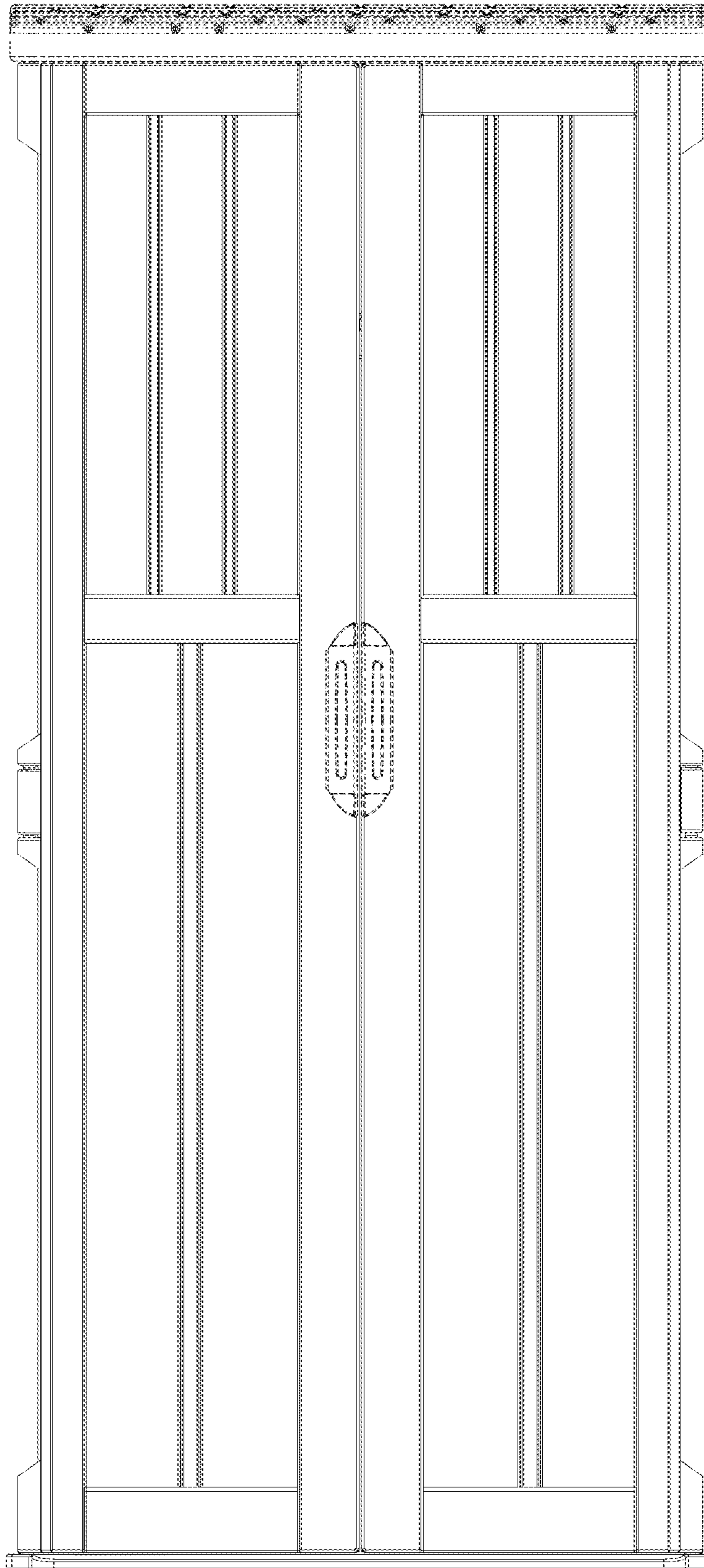

Fig. 3

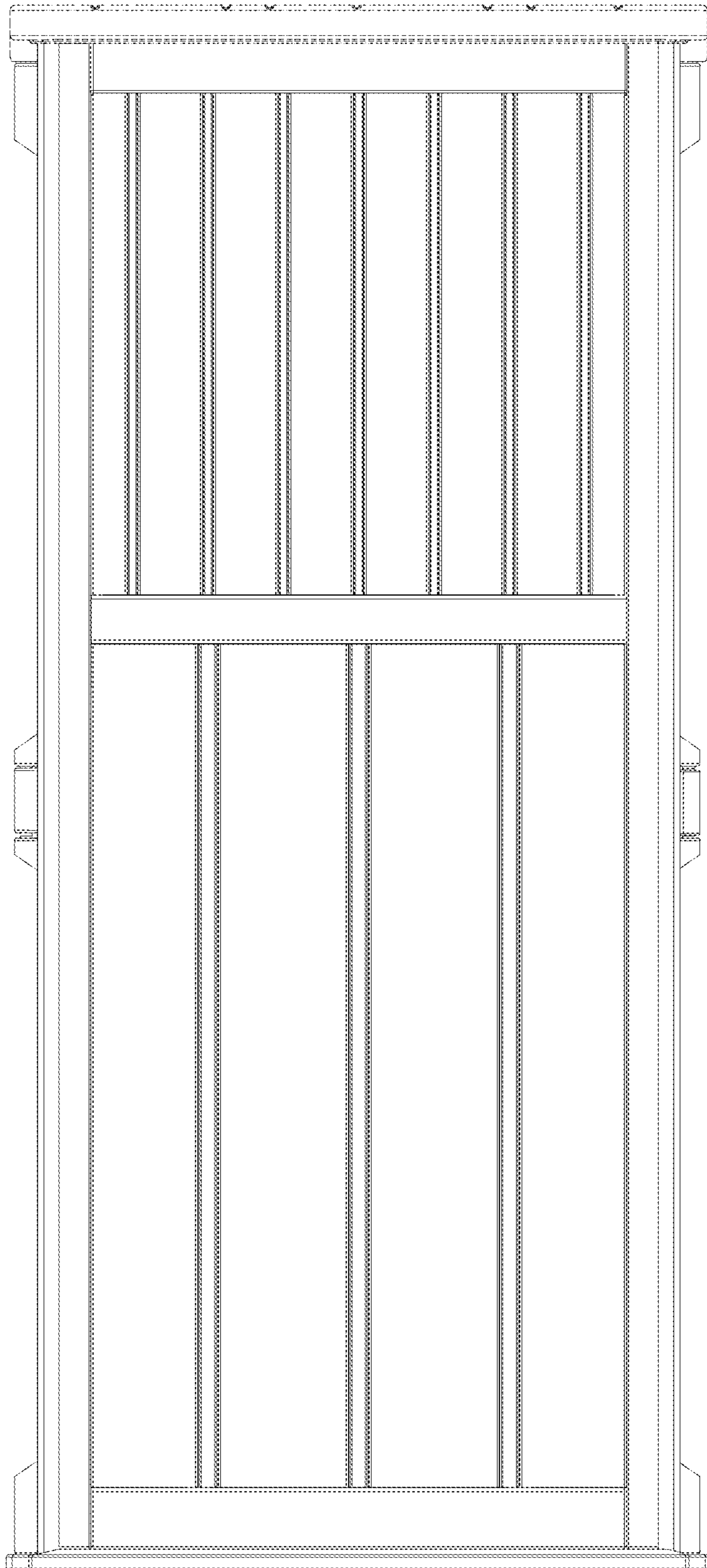

Fig. 4

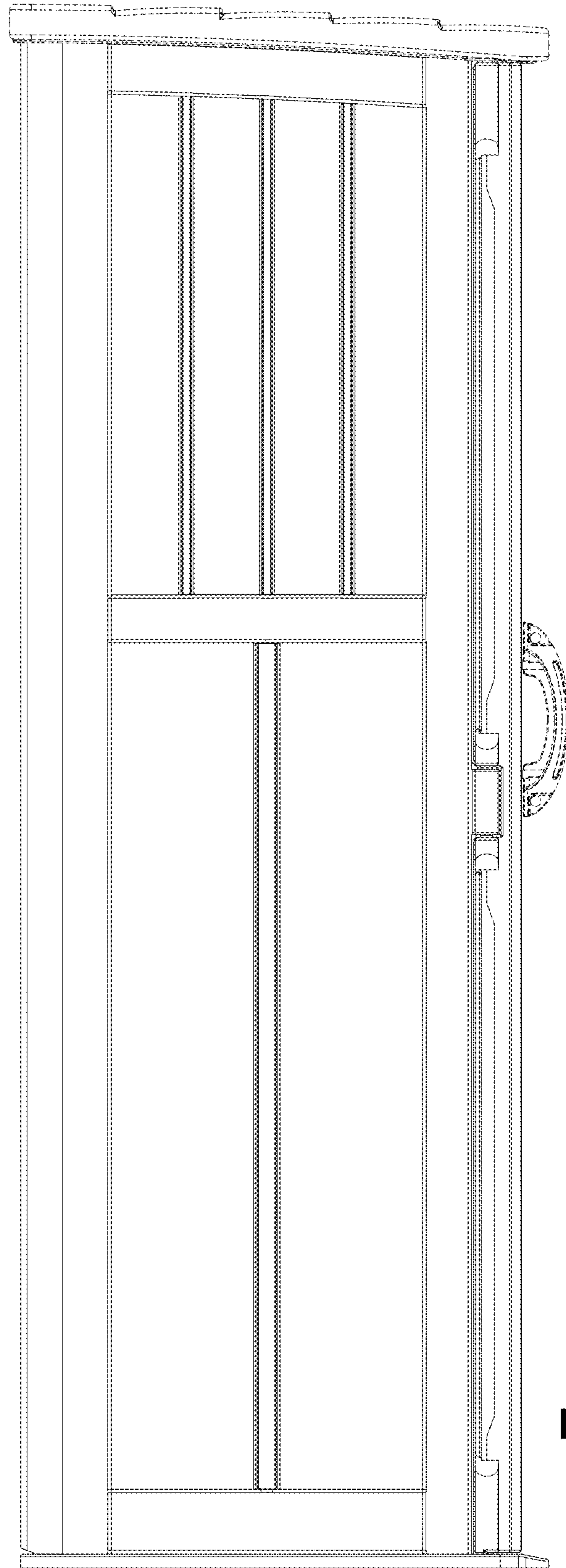

Fig. 5

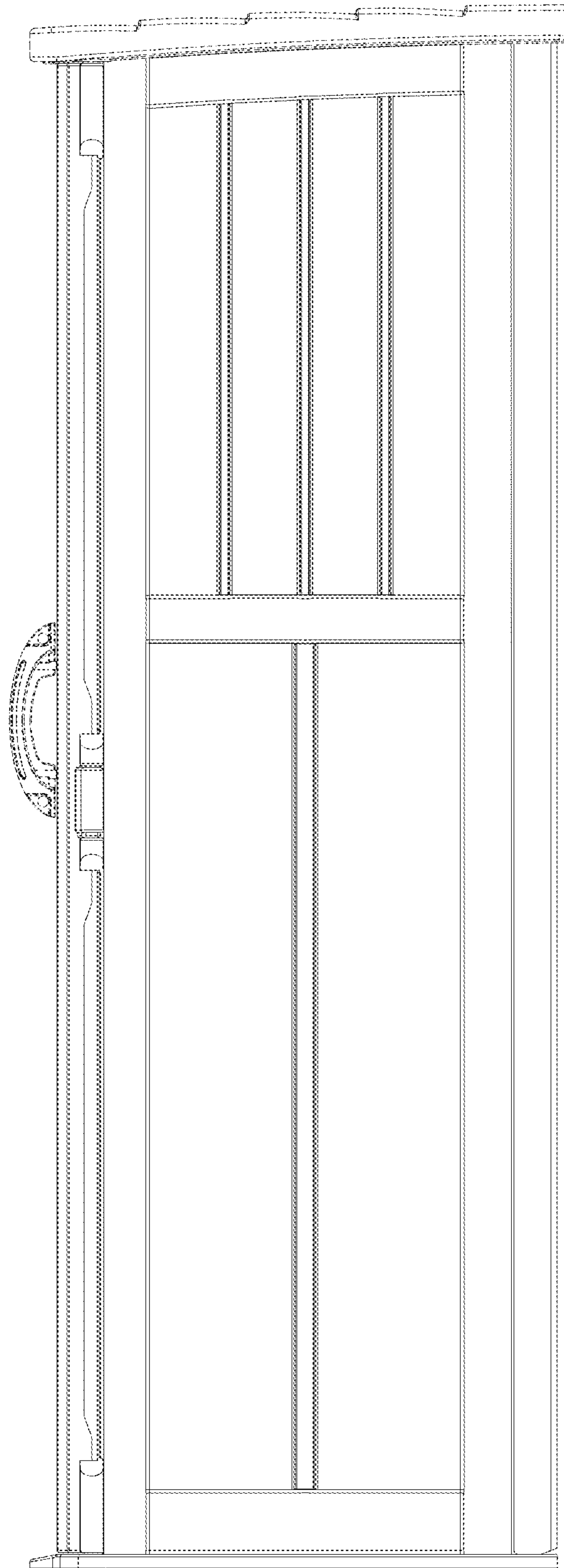

Fig. 6

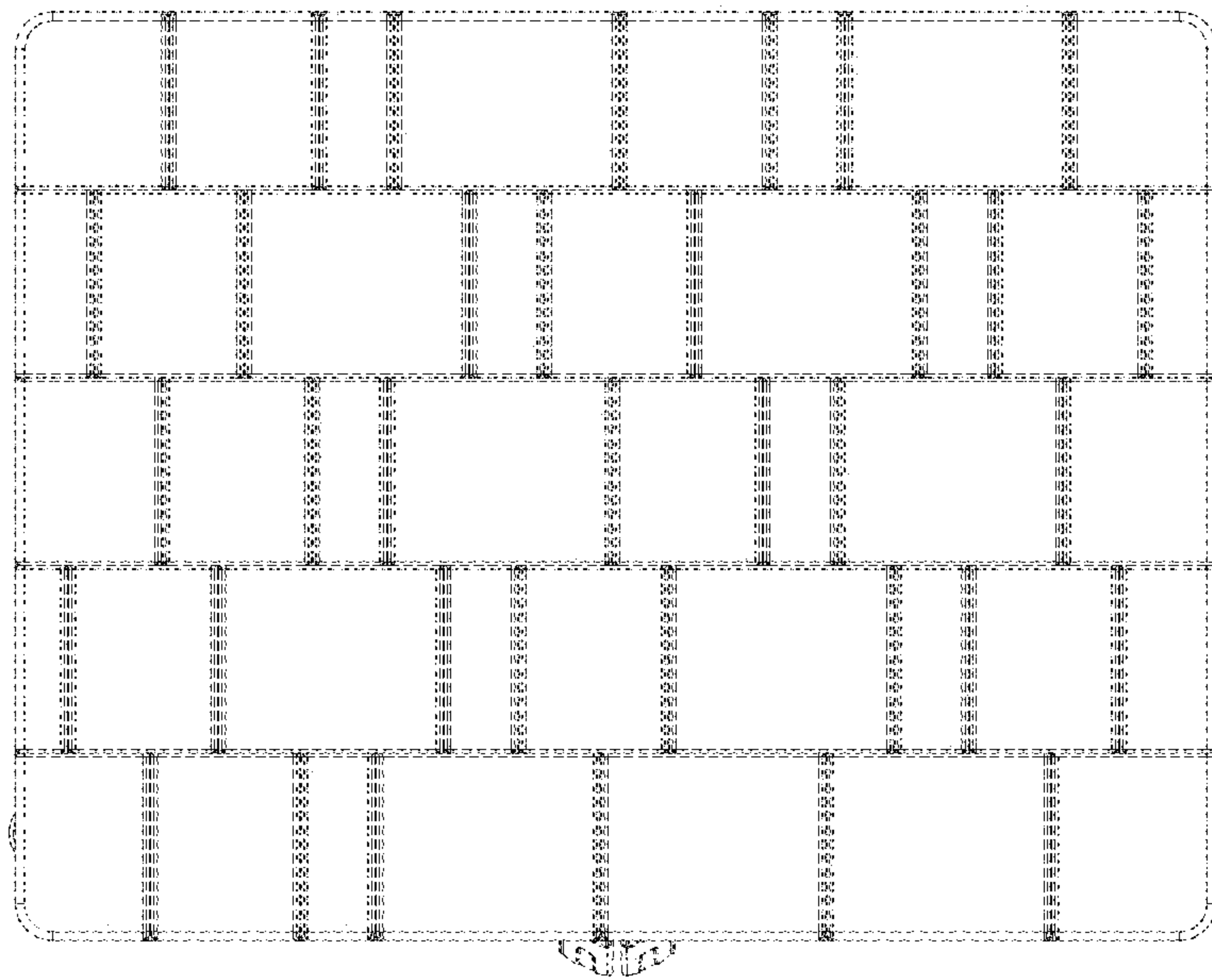

Fig. 7