



US00D943081S

(12) **United States Design Patent**
Bull et al.

(10) **Patent No.:** **US D943,081 S**

(45) **Date of Patent:** **** Feb. 8, 2022**

- (54) **FAN**
- (71) Applicant: **O2COOL, LLC**, Chicago, IL (US)
- (72) Inventors: **Jeff Bull**, Naperville, IL (US); **Tom Zeng**, Shenzhen (CN)
- (73) Assignee: **O2COOL, LLC**, Chicago, IL (US)
- (**) Term: **15 Years**
- (21) Appl. No.: **29/728,290**
- (22) Filed: **Mar. 17, 2020**
- (51) **LOC (13) Cl.** **23-04**
- (52) **U.S. Cl.**
USPC **D23/382**
- (58) **Field of Classification Search**
USPC D23/200, 223, 228, 314, 328, 332, 333,
D23/335, 336, 337, 351, 355, 356, 370,
D23/371, 378-380, 381, 382, 383,
D23/411-412
CPC F04D 25/0673; F04D 25/08; F04D 25/084;
F04D 29/4226
See application file for complete search history.

(56) **References Cited**

U.S. PATENT DOCUMENTS

- D361,832 S * 8/1995 Cuning D23/328
- D387,151 S * 12/1997 Fok D23/332
- D387,422 S * 12/1997 Radtke D23/328
- D415,270 S * 10/1999 Fok D23/332
- D429,326 S * 8/2000 Fok D23/332
- D467,325 S * 12/2002 Ching D23/335
- D546,436 S 7/2007 Chen
- D546,933 S * 7/2007 Chen D23/382
- D565,721 S 4/2008 Chen

- D566,260 S 4/2008 Chen
- D572,359 S 7/2008 Zhuang
- D597,195 S * 7/2009 Zhuang D23/411
- D636,858 S * 4/2011 Ediger D23/335
- D683,010 S * 5/2013 Chen D23/370
- D683,011 S * 5/2013 Chen D23/370
- D684,680 S * 6/2013 Herbst D23/411
- D684,681 S * 6/2013 Herbst D23/412
- D750,212 S * 2/2016 Herbst D23/382
- D752,201 S * 3/2016 Herbst D23/411
- D825,048 S * 8/2018 Breit D23/382
- D892,293 S * 8/2020 Okuhara D23/370
- D895,780 S * 9/2020 Israel D23/335
- D898,894 S * 10/2020 Breit D23/382
- 2013/0108481 A1 * 5/2013 Hoyer F04D 29/601
417/234

* cited by examiner

Primary Examiner — Sharon S Oum

(74) *Attorney, Agent, or Firm* — Thompson Coburn LLP

(57) **CLAIM**

The ornamental design for a fan, as shown and described.

DESCRIPTION

FIG. 1 is a first perspective view of the fan showing our new design;

FIG. 2 is a right side view thereof;

FIG. 3 is a left side view thereof;

FIG. 4 is a rear view thereof;

FIG. 5 is a front view thereof;

FIG. 6 is a top view thereof;

FIG. 7 is a bottom view thereof; and,

FIG. 8 is a second perspective view thereof.

The broken lines are directed to portions of the fan that form no part of the claim.

1 Claim, 7 Drawing Sheets

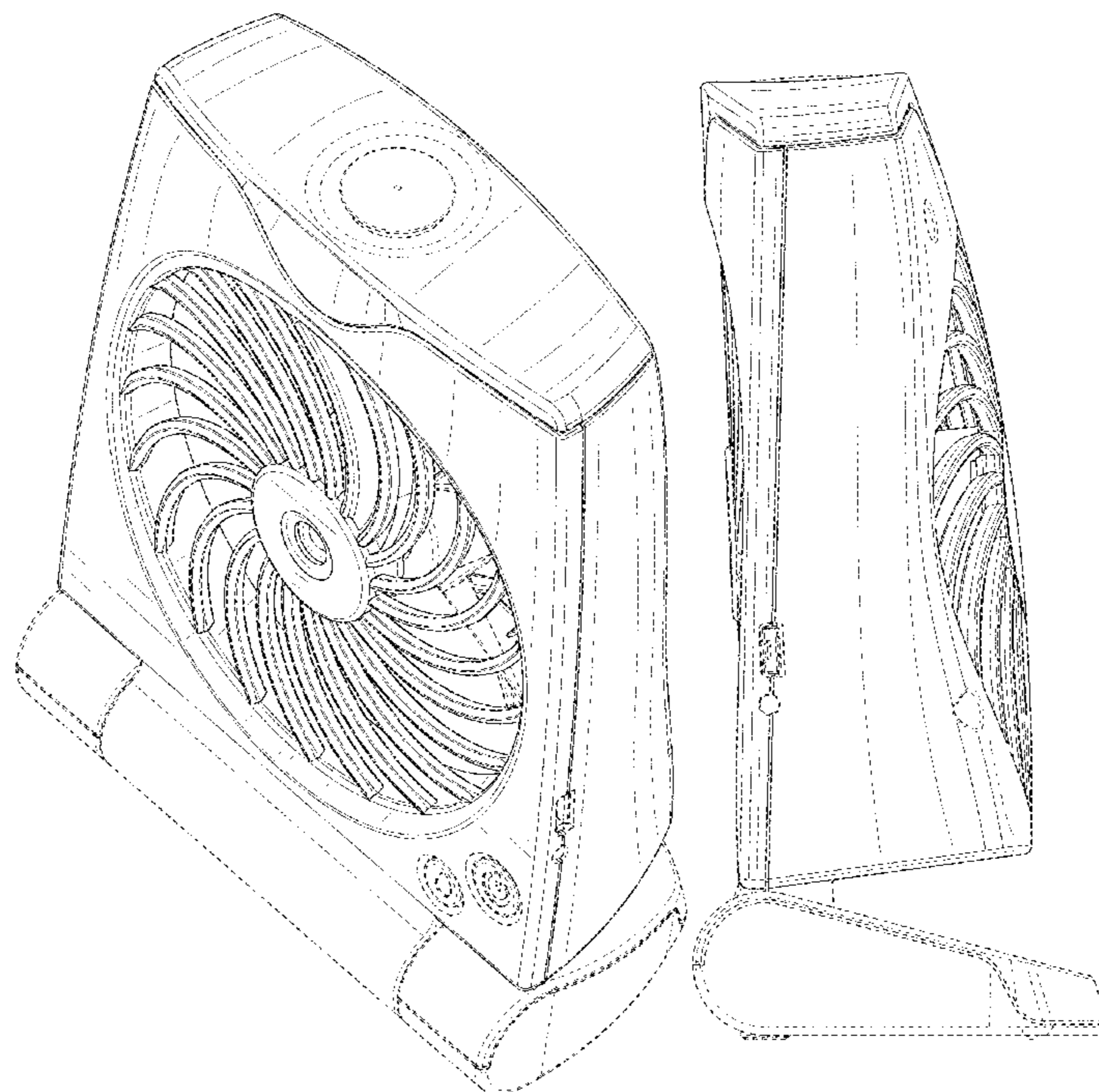

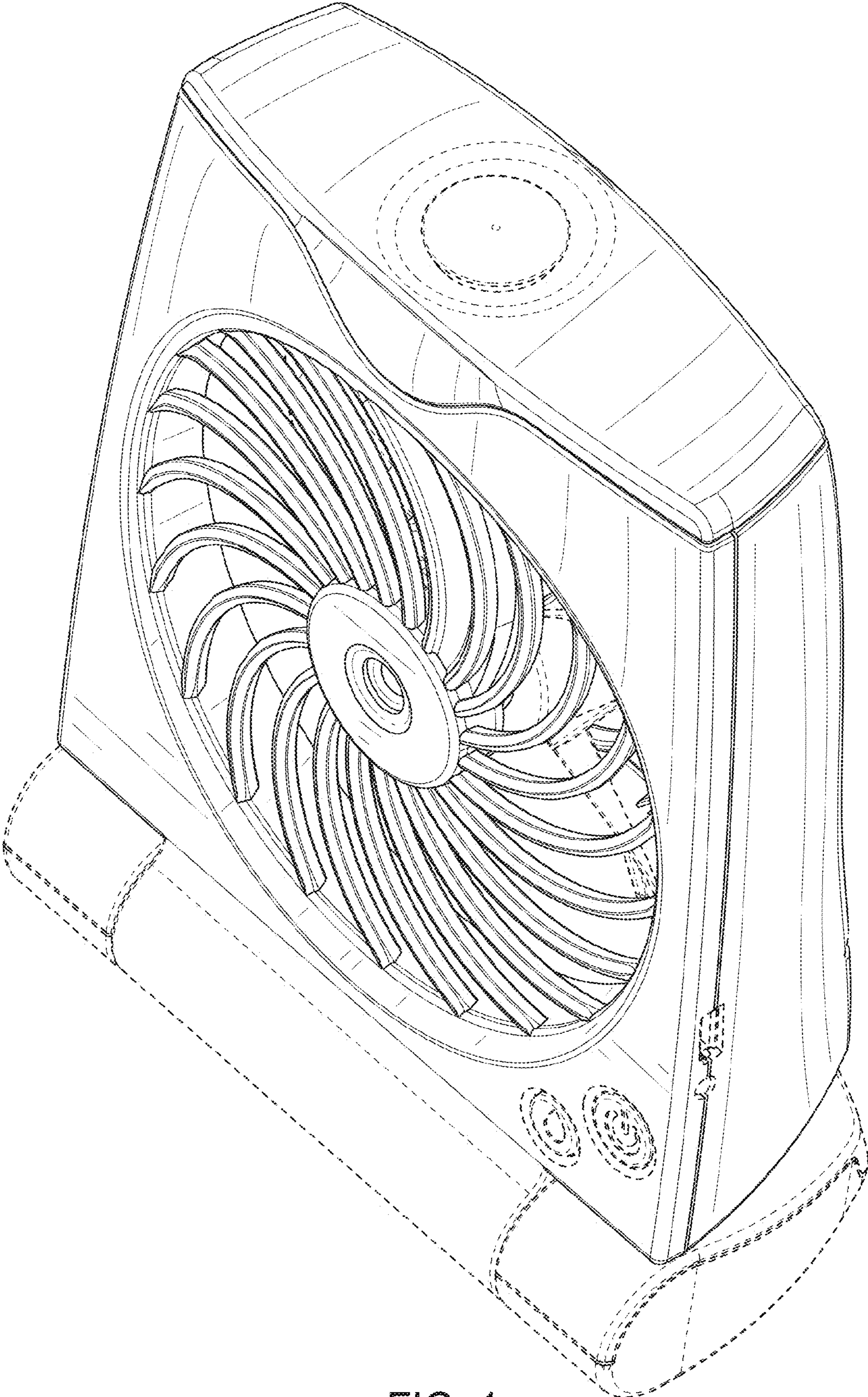

FIG. 1

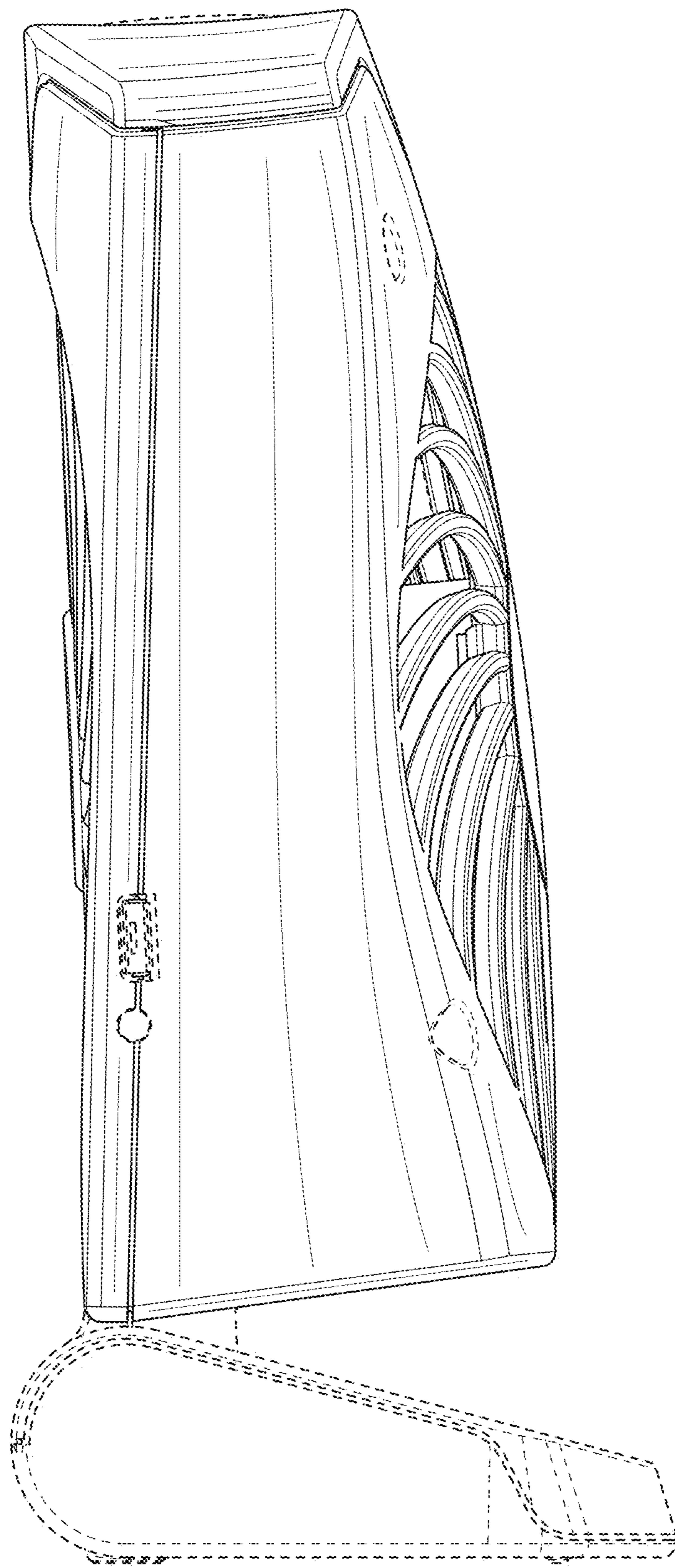

FIG. 2

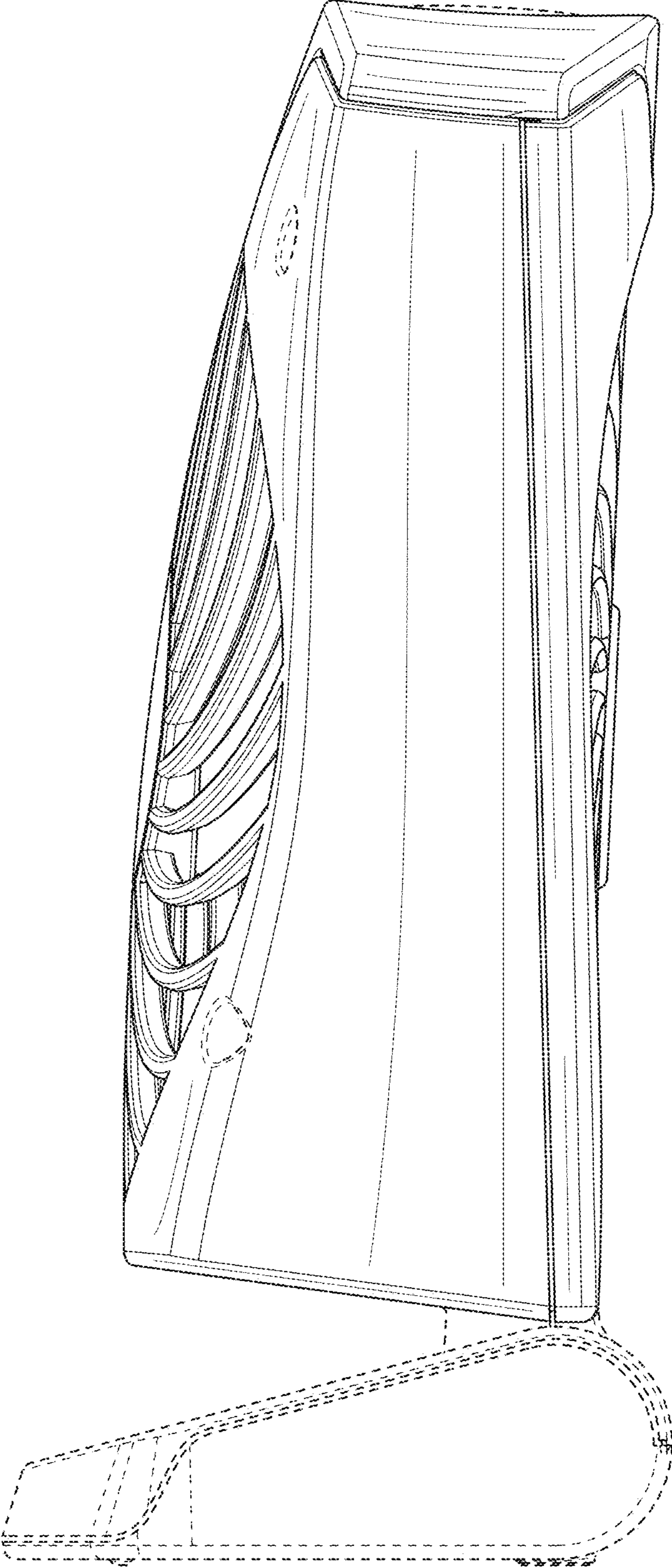

FIG. 3

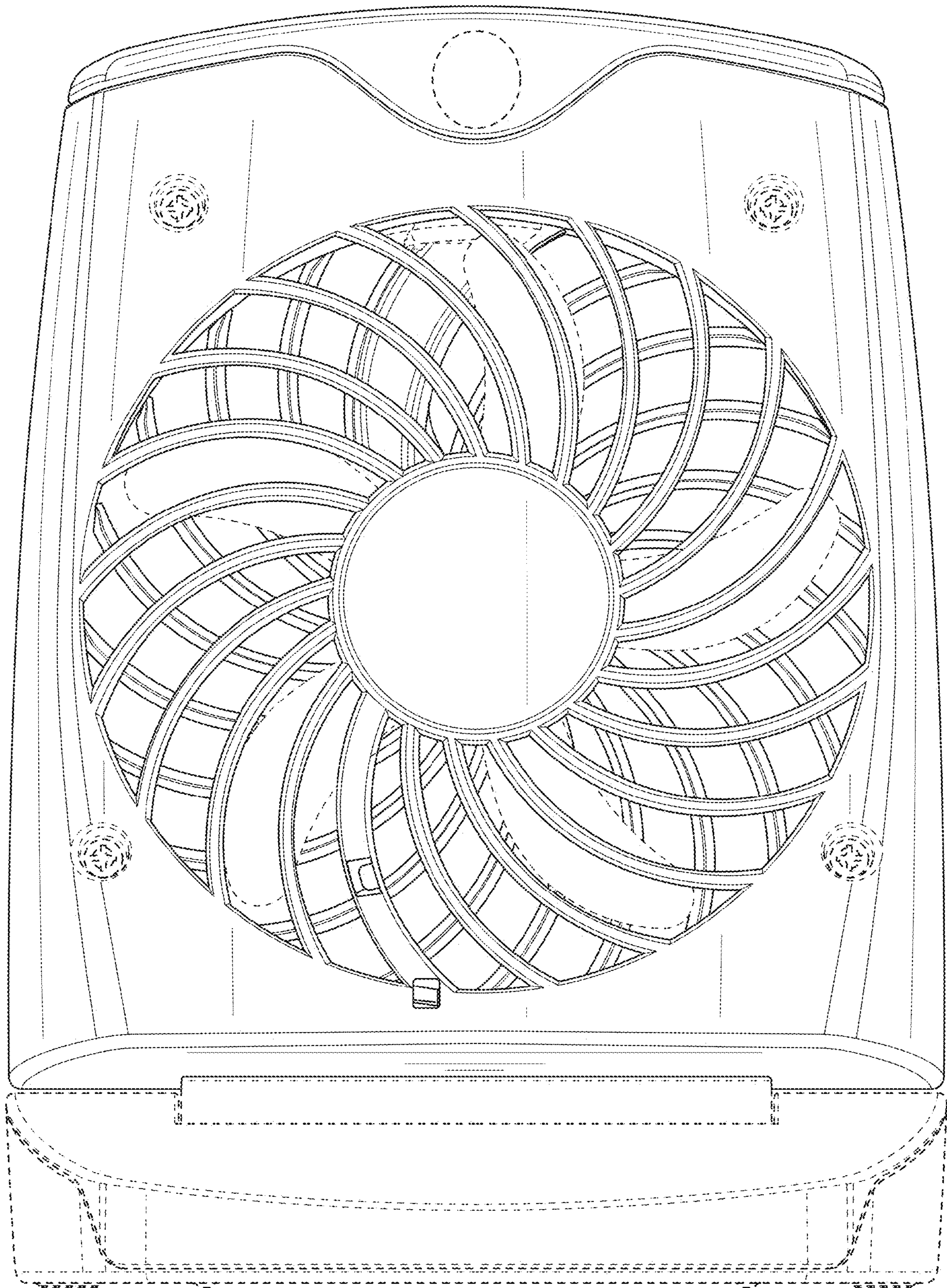

FIG. 4

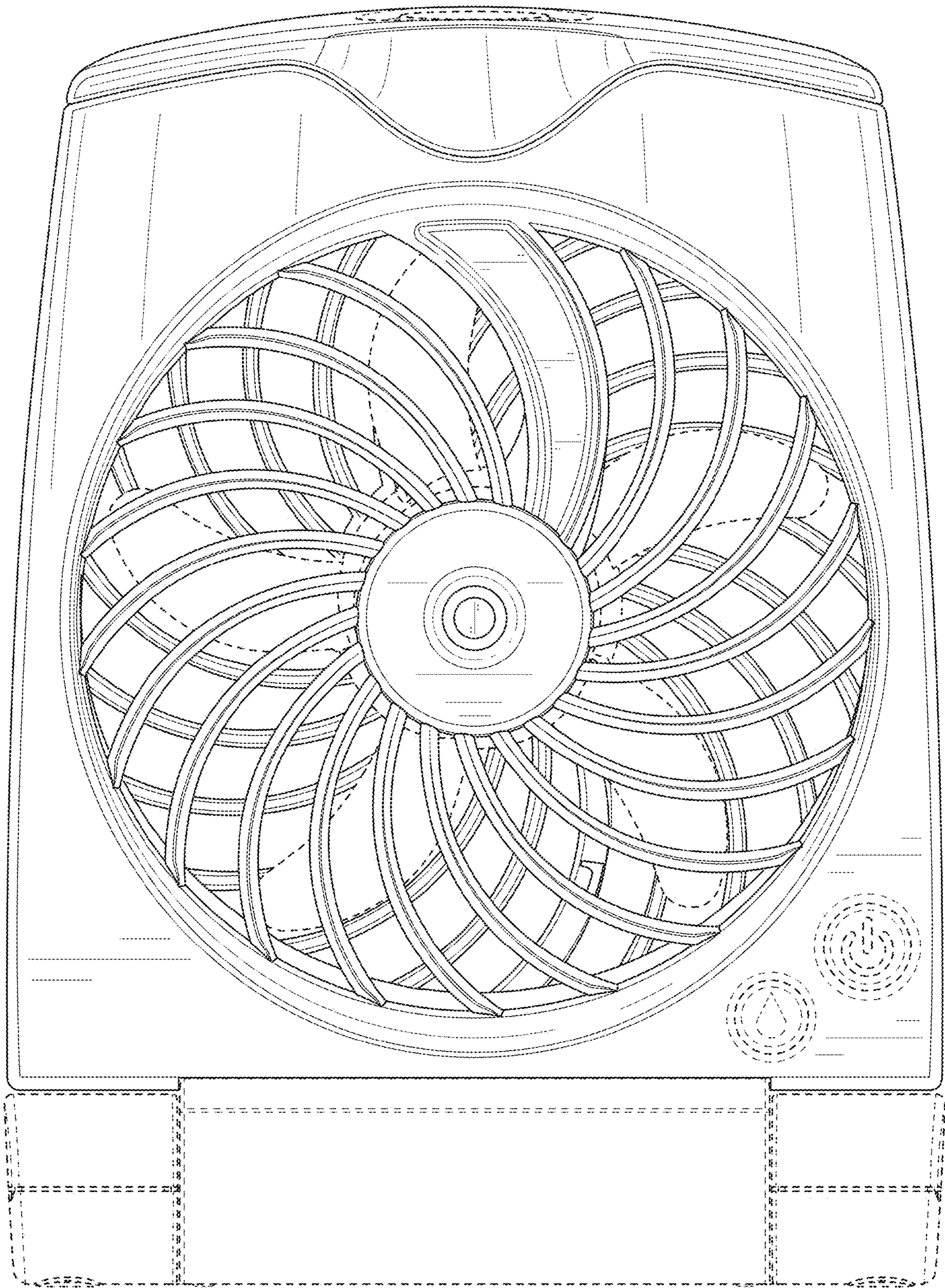

FIG. 5

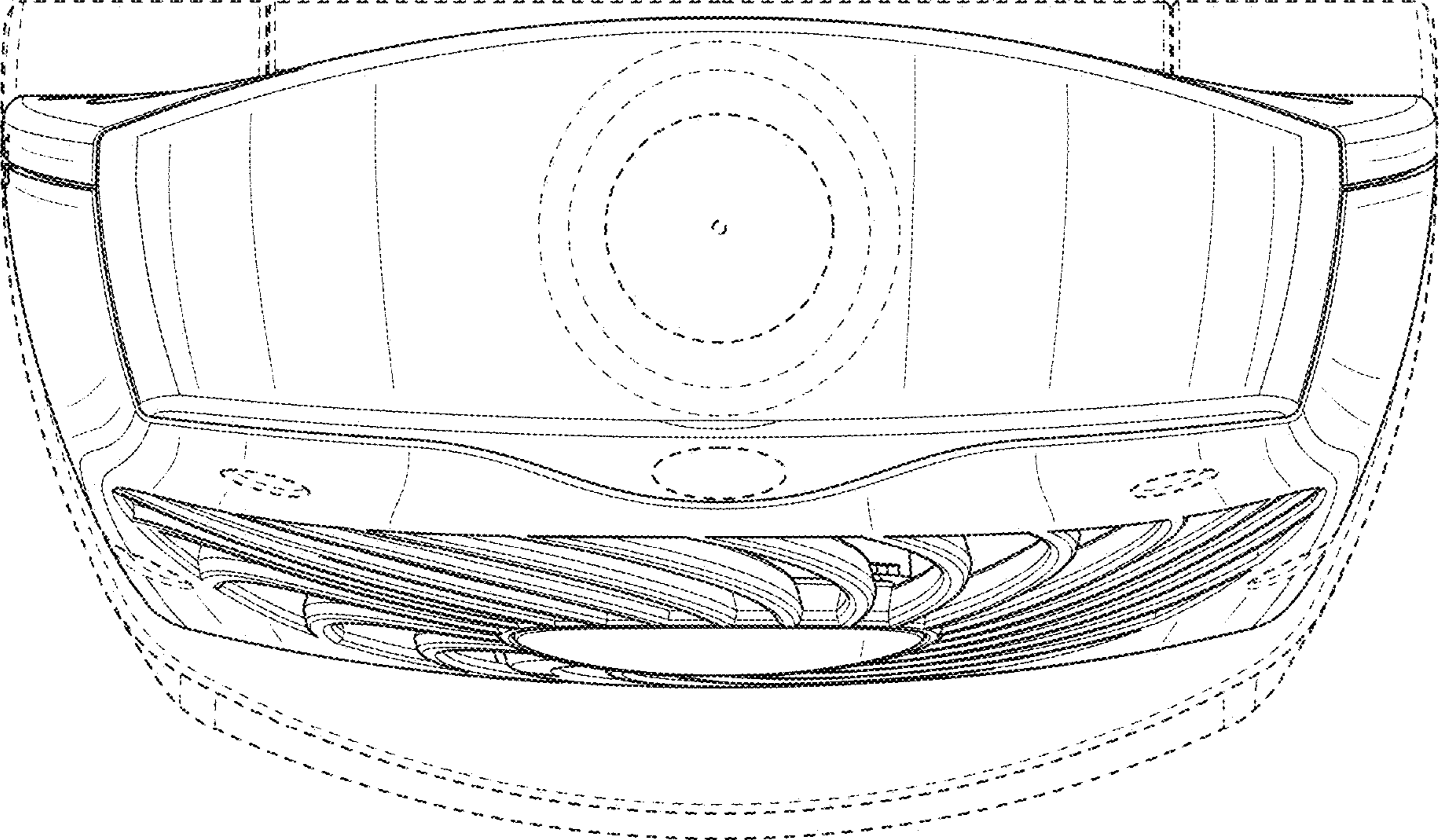

FIG. 6

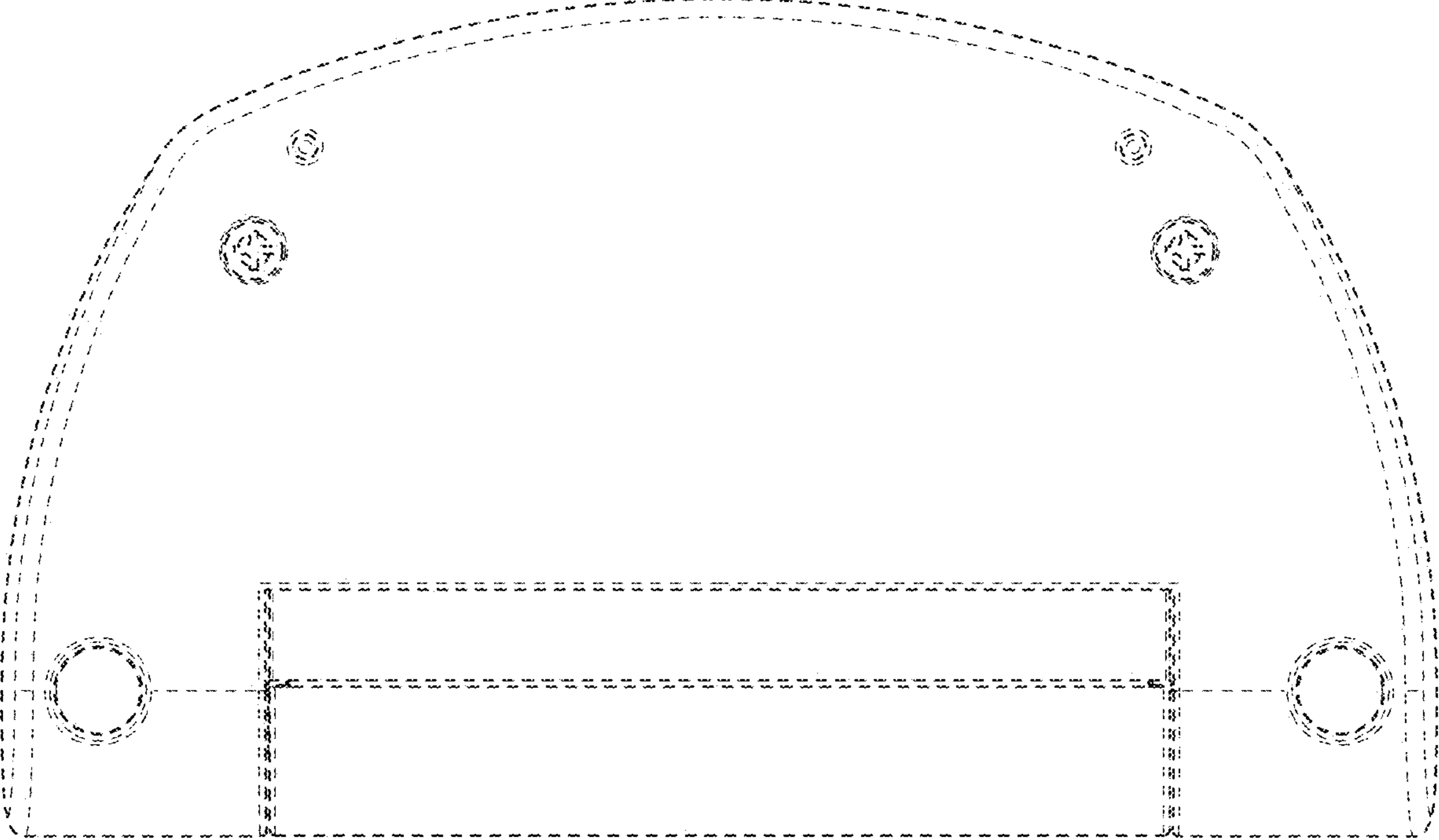

FIG. 7

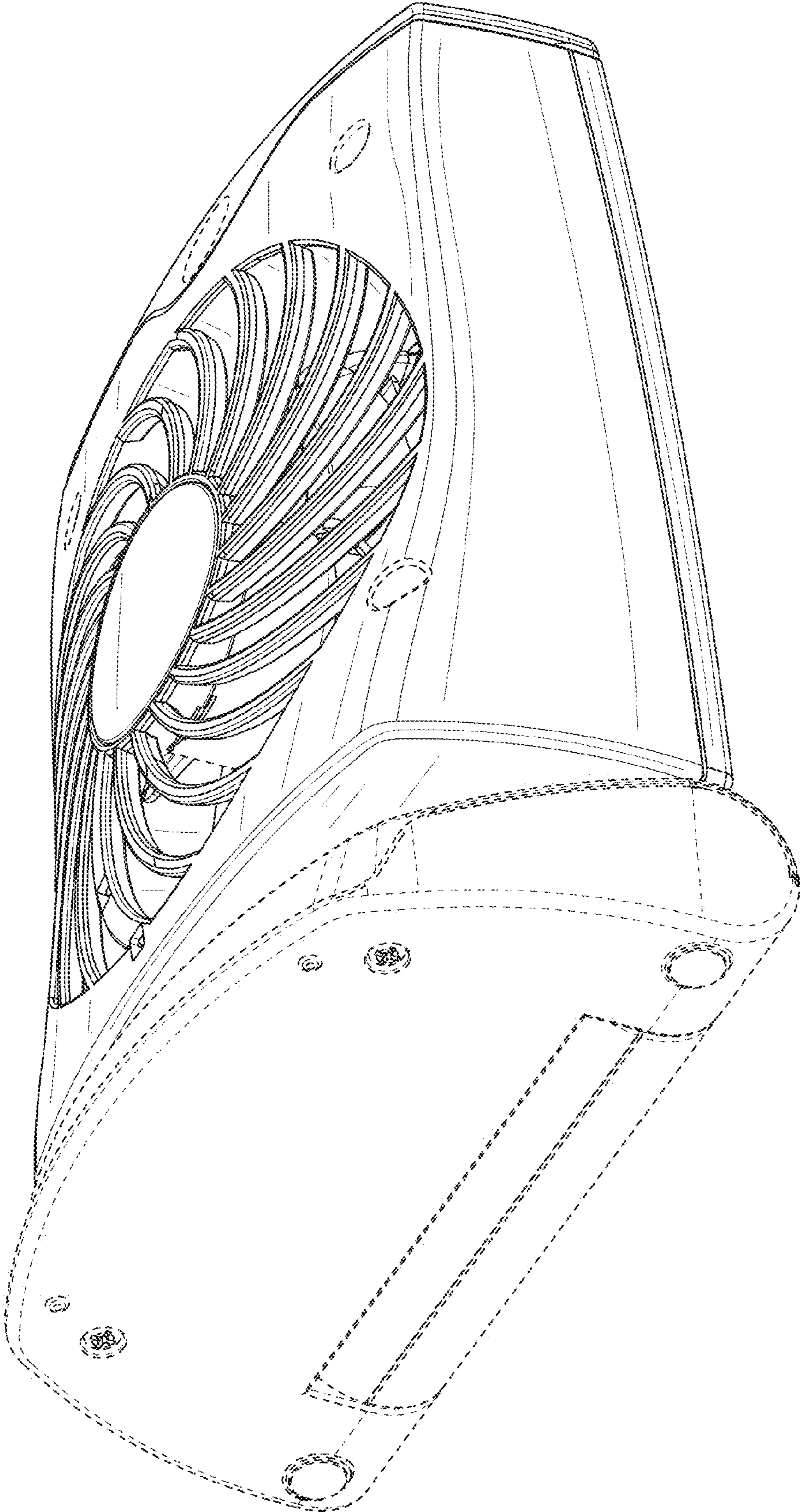

FIG. 8