



US00D942958S

(12) **United States Design Patent** (10) **Patent No.:** **US D942,958 S**
Maier et al. (45) **Date of Patent:** **** Feb. 8, 2022**

(54) **HOLDER FOR A REMOTE CONTROL**
(71) Applicant: **fm marketing gmbh**, Neumarkt am Wallersee (AT)
(72) Inventors: **Ferdinand Maier**, Neumarkt am Wallersee (AT); **Erwin Weitgasser**, Salzburg (AT)
(73) Assignee: **fm marketing gmbh**, Neumarkt am Wallersee (AT)

(**) Term: **15 Years**
(21) Appl. No.: **29/696,424**
(22) Filed: **Jun. 27, 2019**

Related U.S. Application Data

(62) Division of application No. 35/504,864, filed on Jul. 25, 2017 (U.S. filing date under 35 U.S.C. 384), and having an international filing date of Jul. 25, 2017, now Pat. No. Des. 864,128.

Foreign Application Priority Data

Feb. 24, 2017 (EP) 003765445
(51) **LOC (13) Cl.** **14-03**
(52) **U.S. Cl.**
USPC **D13/168**; D14/218; D8/352
(58) **Field of Classification Search**
USPC D13/168; D14/217, 218, 434; D6/512; D8/352; D16/242; D26/142
CPC H05K 5/0204; F16M 13/00; H01H 9/02; H01H 9/0214; H01H 9/0235; H01H 9/0242; H01H 9/025; G08C 17/00; G08C 17/02; A47C 31/008; A61G 13/02; G07C 9/00944

See application file for complete search history.

(56) **References Cited**
U.S. PATENT DOCUMENTS
D247,844 S * 5/1978 Palm, Jr. D8/352
D247,845 S * 5/1978 Palm, Jr. D8/352
D326,806 S * 6/1992 Marques D8/352
D359,673 S * 6/1995 Gibson D8/352
D380,854 S * 7/1997 Bray D26/142
D386,007 S * 11/1997 Eckhardt D11/131
D421,149 S * 2/2000 Chen D26/142
D437,771 S * 2/2001 Barnes D8/352
D444,910 S * 7/2001 Lee D26/142
(Continued)

FOREIGN PATENT DOCUMENTS

CN 303691639 11/2015
CN 303888105 5/2016
EM 002398354-0001 2/2014

OTHER PUBLICATIONS

Elago Wall Plate Designed for Google Nest Hello Wall Plate ; May 9, 2018; 3 pgs.;https://www.amazon.com/elago-Wall-Plate-Hello-White/dp/B07CYRQV5X/ref=sr_1_15?keywords=HOLACA%2BWall%2BPlate%2BCome%2Bwith%2BL35%C2%B0%2FR35%2B%C2%B0%2BWedge%2Bfor%2BNest%2BHello%2C%2BPlastic%2BMaterial%2BAdjustment%2BMounting%2BWall%2B
(Continued)

Primary Examiner — Selina Sikder
(74) *Attorney, Agent, or Firm* — Stinson LLP

(57) **CLAIM**
The ornamental design for a holder for a remote control, as shown and described.

DESCRIPTION

FIG. 1 is a rear side view of the holder of the invention;
FIG. 2 is a top view;
FIG. 3 is a bottom view;
FIG. 4 is a left side elevation;
FIG. 5 is a right side elevation;
FIG. 6 is a front elevation; and,
FIG. 7 is a perspective view.

1 Claim, 4 Drawing Sheets

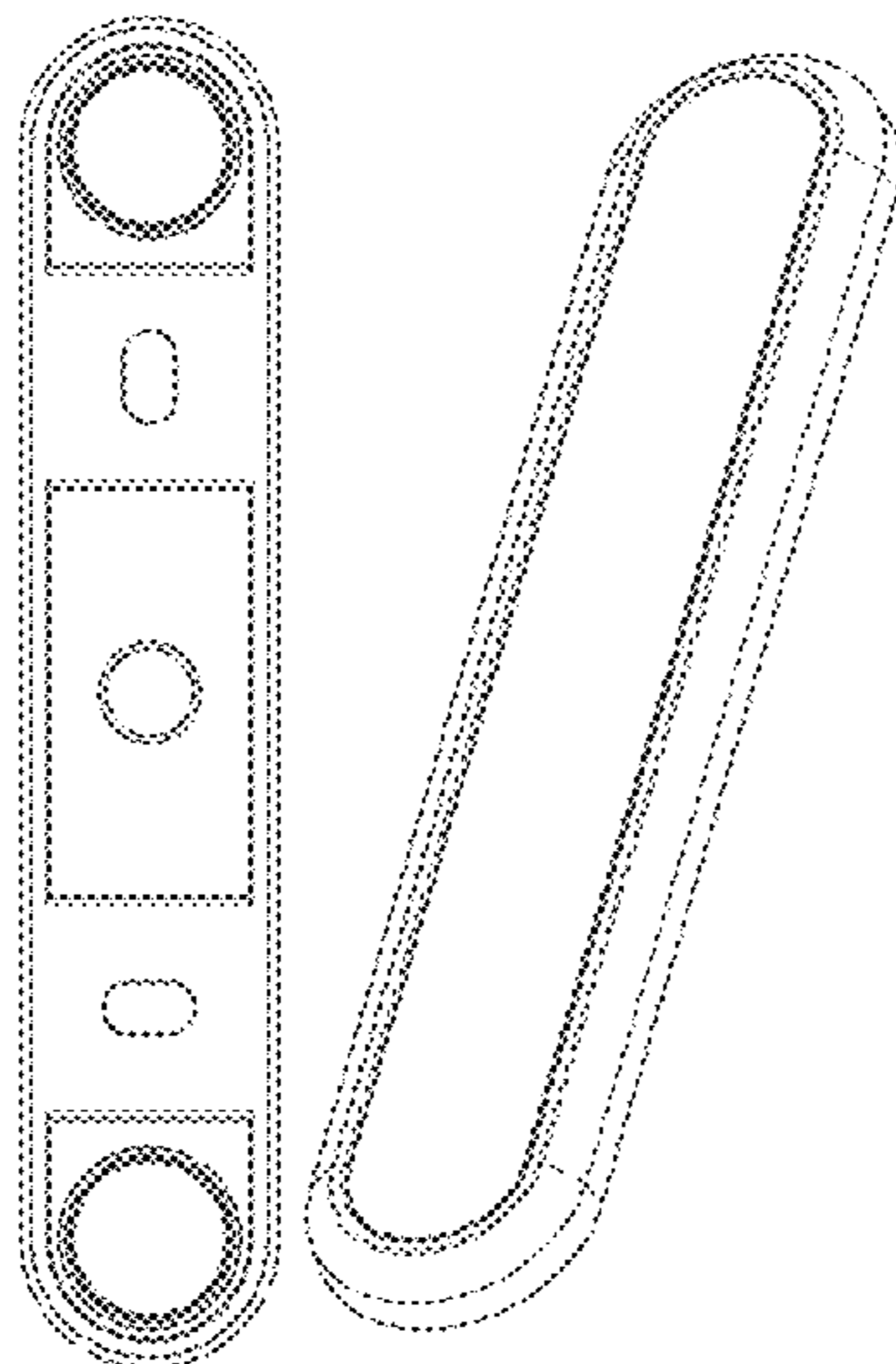

(56)

References Cited

U.S. PATENT DOCUMENTS

D485,534 S 1/2004 Mayo et al.
 D493,565 S * 7/2004 Smith D26/118
 D570,101 S * 6/2008 Harris D3/218
 D582,417 S * 12/2008 Sheba D14/217
 D589,941 S 4/2009 Maier et al.
 D611,932 S 3/2010 Maier et al.
 D615,469 S * 5/2010 Huang D12/190
 D622,263 S 8/2010 Maier et al.
 D631,467 S * 1/2011 Shimizu D14/217
 D633,479 S 3/2011 Maier
 D634,735 S 3/2011 Maier
 D640,526 S * 6/2011 Cash D8/352
 D641,367 S * 7/2011 Morabito D14/434
 D642,726 S * 8/2011 Khubani D26/80
 D644,647 S * 9/2011 Sykes D14/447
 8,330,638 B2 * 12/2012 Altonen H05B 47/19
 341/176
 D692,417 S 10/2013 Tu
 D693,813 S * 11/2013 Symons D14/432
 D697,055 S 1/2014 McManigal
 8,695,934 B2 * 4/2014 Jensen F16M 13/02
 248/205.1
 D706,516 S * 6/2014 Caglia D1/105
 D724,547 S 3/2015 Baldwin et al.
 D724,568 S 3/2015 Peh
 D726,831 S 4/2015 Lee et al.
 D736,706 S * 8/2015 Huang D13/108
 D743,474 S * 11/2015 Wada D16/242
 D746,428 S * 12/2015 Martinez D23/366
 D756,022 S * 5/2016 Shipman D26/113
 D760,699 S 7/2016 Peh
 D763,204 S 8/2016 Ikegaya et al.
 D763,830 S 8/2016 Jones et al.
 D764,443 S 8/2016 Cai
 D770,194 S * 11/2016 Langhammer D6/512
 D773,941 S * 12/2016 Holzer D10/22
 D797,059 S 9/2017 Gong
 D803,374 S * 11/2017 Patton D23/366
 D805,058 S 12/2017 Akana et al.
 D825,495 S 8/2018 Yagisawa et al.
 D836,640 S * 12/2018 Hou D14/433
 D847,621 S * 5/2019 Kolar D8/381

D847,741 S * 5/2019 Hu D13/108
 D855,606 S * 8/2019 Kim D14/250
 D864,128 S * 10/2019 Ferdinand D13/168
 D868,609 S * 12/2019 Wang D10/106.6
 D869,606 S * 12/2019 Kyung D23/213
 D880,021 S * 3/2020 Meise D26/24
 D887,413 S * 6/2020 Lou D14/434
 D914,641 S * 3/2021 Bowers D14/218
 D915,353 S * 4/2021 Maier D14/218
 D934,092 S * 10/2021 Luebeck D10/104.1
 2007/0272044 A1 * 11/2007 Huang H05K 5/0204
 74/10 A
 2009/0251352 A1 * 10/2009 Altonen H01H 9/02
 341/176
 2012/0014046 A1 * 1/2012 Kuan H05K 5/0204
 361/679.01
 2012/0019994 A1 * 1/2012 Kuan F16M 11/105
 361/679.01
 2013/0265698 A1 10/2013 Baum et al.
 2015/0108313 A1 * 4/2015 Leung F16M 11/105
 248/351
 2018/0137992 A1 * 5/2018 Escurier H01H 9/025
 2018/0188779 A1 * 7/2018 Allen H01H 1/10
 2018/0350535 A1 12/2018 Maier
 2019/0104623 A1 * 4/2019 Backus H05K 5/0204

OTHER PUBLICATIONS

AirTech Home Automation—Nest Hello Wall Plate ; Apr. 8, 2019; 2 pgs.; https://www.amazon.com/dp/B07QBGR47Q/ref=sspa_dk_detail_0?psc=1&pd_rd_i=B07QBGR47Q&pd_rd_w=yHjjD&pf_rd_p=9fd3ea7c-b77c-42ac-b43b-c872d3f37c38&pd_rd_wg=bQPpE&pf_rd_r=RMR42QZ5HTZ5FBHKKY53&pd_rd_r=f179b6b7-47d6-40e0-ab21-6c33b781c1fc&spLa.*
 Ruwido tau remote control, no date available, [online], [site visited May 28, 2019]. Retrieved from url:<https://www.ruwido.com/products/tau/> (Year 2019).
 Anycon new generation of smart toilet remote control production.—Uni Play, Mar. 14, 2018, [online], [site visited May 28, 2019]. Retrieved from url: <https://myuniplay.com/anycon-new-generation-of-smart-toilet-remote-control-production/> (Year: 2018).

* cited by examiner

FIG. 1

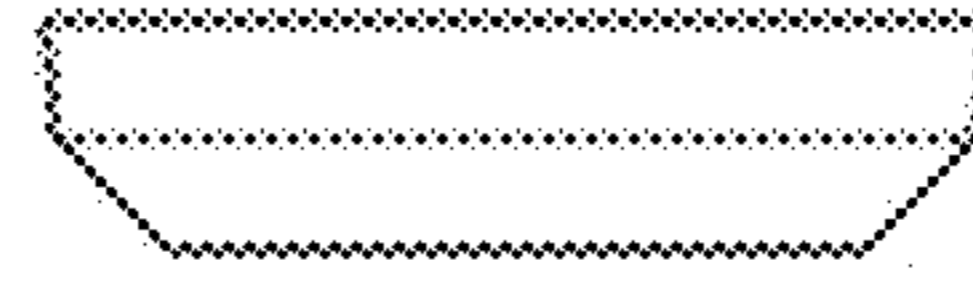

FIG. 2

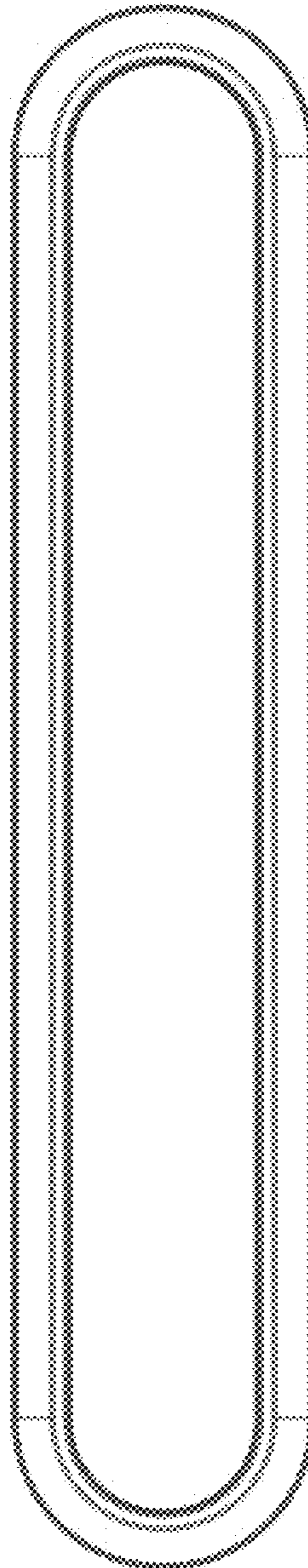

FIG. 3

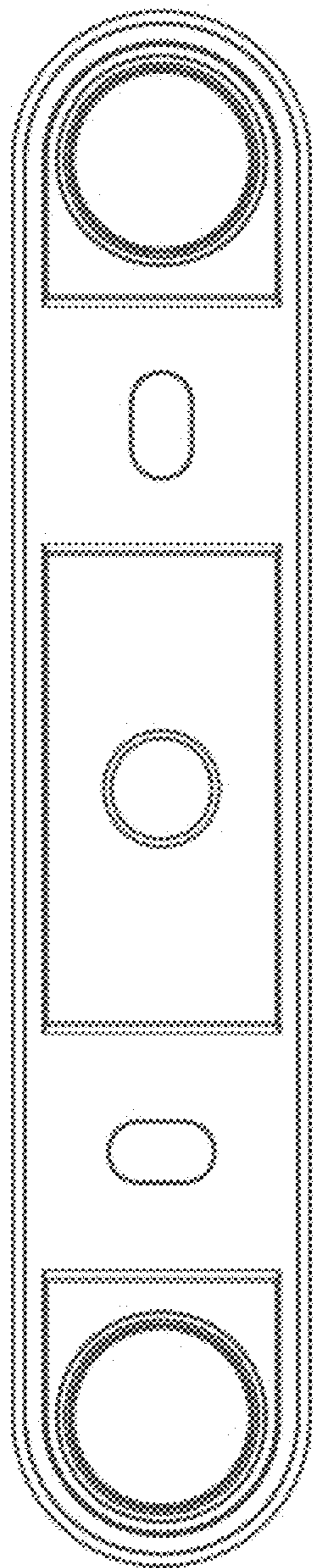

FIG. 4

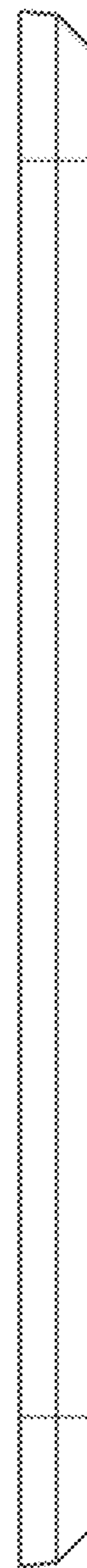

FIG. 5

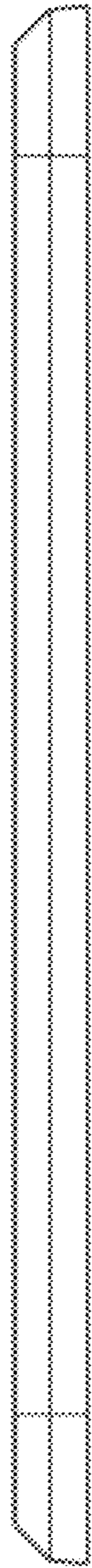

FIG. 6

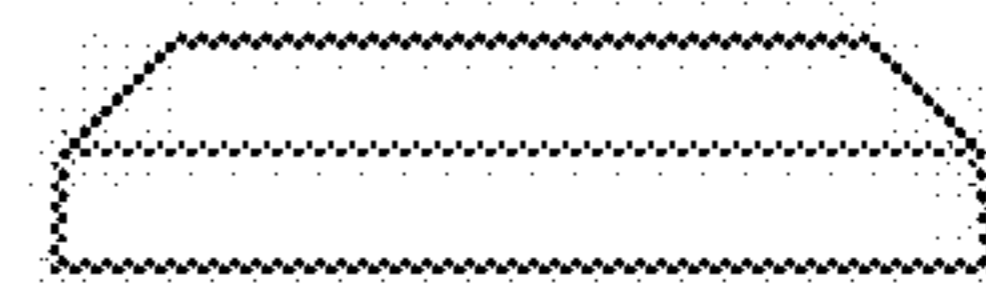

FIG. 7

