



US00D942909S

(12) **United States Design Patent** (10) **Patent No.:** **US D942,909 S**  
**Kim et al.** (45) **Date of Patent:** **\*\* \*Feb. 8, 2022**

(54) **VEHICLE MIRROR**

(56) **References Cited**

(71) Applicant: **Ford Global Technologies, LLC**,  
Dearborn, MI (US)  
(72) Inventors: **Soohyoung Kim**, Northville, MI (US);  
**Damon G. Depeyster**, Northville, MI  
(US); **Gordon M. Platto**, Troy, MI  
(US)  
(73) Assignee: **Ford Global Technologies, LLC**,  
Dearborn, MI (US)

U.S. PATENT DOCUMENTS

|              |         |                  |         |
|--------------|---------|------------------|---------|
| D792,824 S * | 7/2017  | Bucher .....     | D12/187 |
| D837,705 S * | 1/2019  | Bucher .....     | D12/187 |
| D865,598 S * | 11/2019 | Grand .....      | D12/187 |
| D886,015 S * | 6/2020  | Kim .....        | D12/187 |
| D891,339 S * | 7/2020  | Tanghe .....     | D12/187 |
| D904,260 S * | 12/2020 | Piaskowski ..... | D12/187 |
| D908,566 S * | 1/2021  | Zhao .....       | D12/187 |
| D913,881 S * | 3/2021  | Hilliard .....   | D12/187 |

\* cited by examiner

(\*) Notice: This patent is subject to a terminal disclaimer.

*Primary Examiner* — Abraham Bahta

(\*\*) Term: **15 Years**

(57) **CLAIM**

(21) Appl. No.: **29/736,746**

The ornamental design for a vehicle mirror, as shown and described.

(22) Filed: **Jun. 2, 2020**

**DESCRIPTION**

**Related U.S. Application Data**

(62) Division of application No. 29/650,662, filed on Jun. 8, 2018, now Pat. No. Des. 886,015.

(51) **LOC (13) Cl.** ..... **12-16**

(52) **U.S. Cl.**  
USPC ..... **D12/187**

(58) **Field of Classification Search**  
USPC ..... D12/114, 187-189, 191, 400, 404, 181;  
D6/300, 309; 359/843, 844, 881, 877,  
359/604, 868, 838, 839, 841, 514, 871;  
248/466, 474

CPC ..... B60R 1/076; B60R 1/074; B60R 1/078;  
B60R 1/08; B60R 1/006; B60R 1/02;  
B60R 1/06; B60R 1/0612; B60R 1/062;  
B60R 1/064; G02B 7/182; G02B 7/18

See application file for complete search history.

FIG. 1 is a front elevational view of a vehicle mirror, showing our new design;  
FIG. 2 is a rear elevation view thereof;  
FIG. 3 is a left side elevational view thereof;  
FIG. 4 is a right side elevational view thereof;  
FIG. 5 is a top plan view thereof;  
FIG. 6 is a bottom plan view thereof;  
FIG. 7 is a top, front, and left side perspective view thereof;  
and,  
FIG. 8 is a bottom, front, and left side perspective view thereof.  
Any broken lines represent an internal boundary of the design; the line itself and the area within form no part of the claim.

**1 Claim, 8 Drawing Sheets**

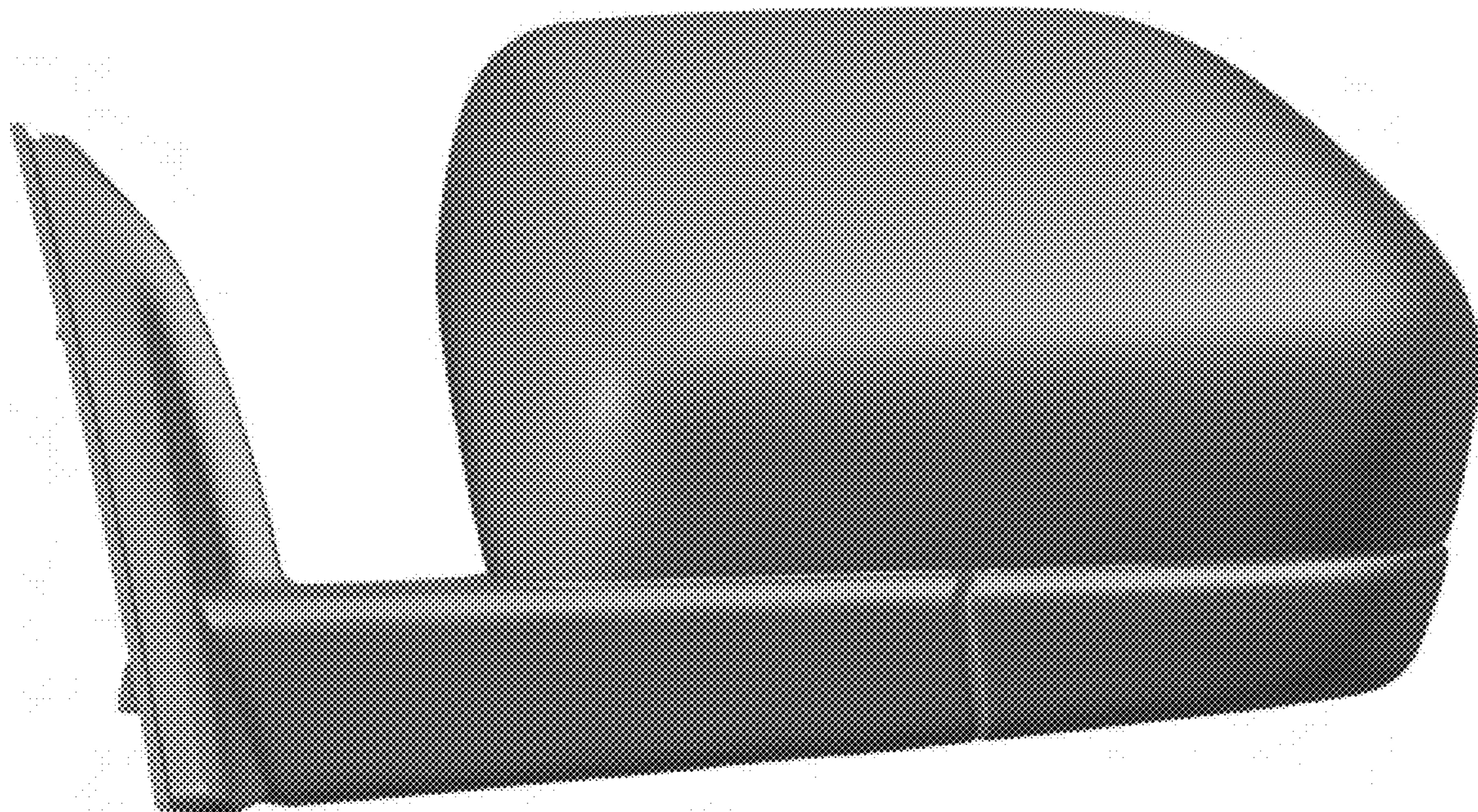



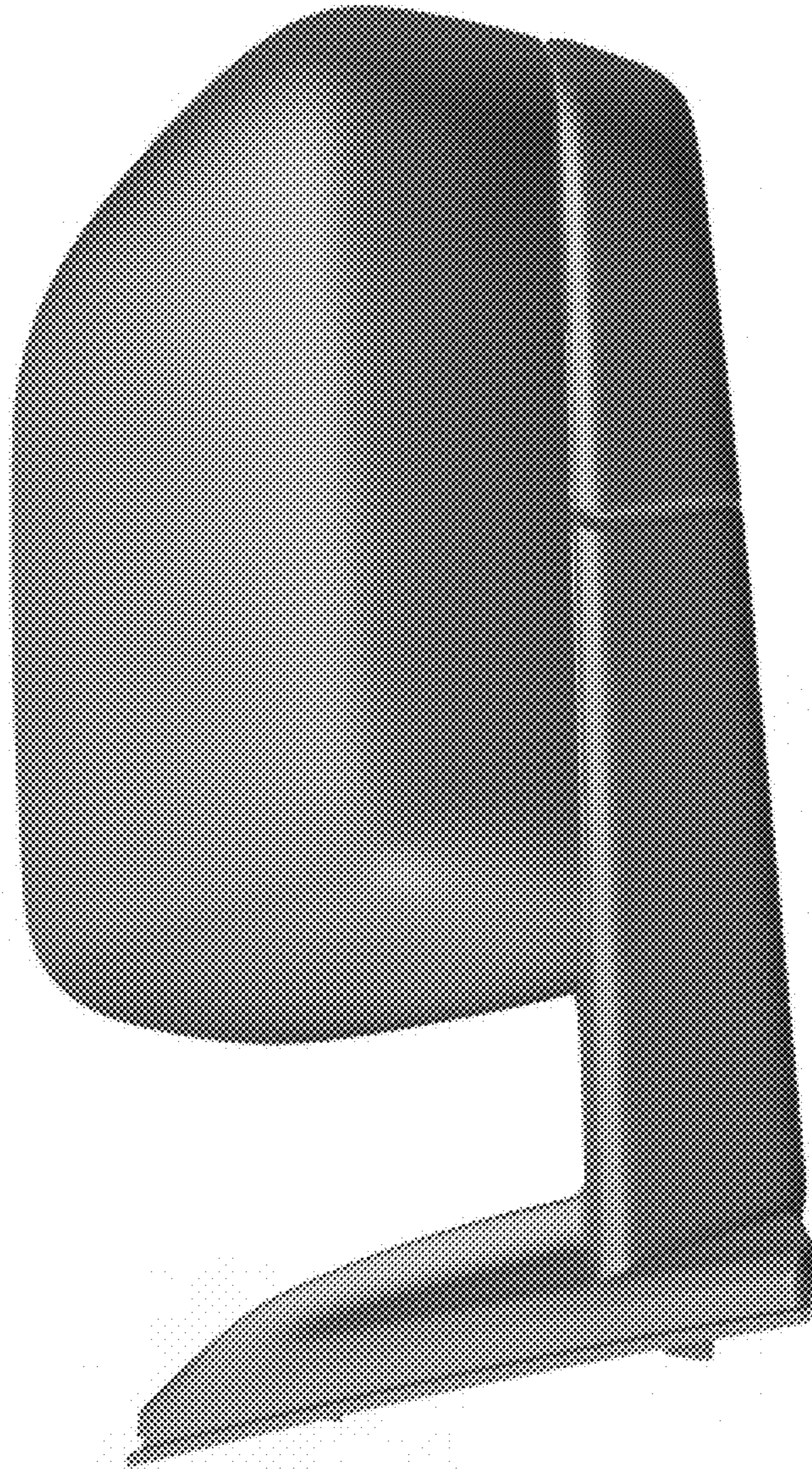

Fig. 1



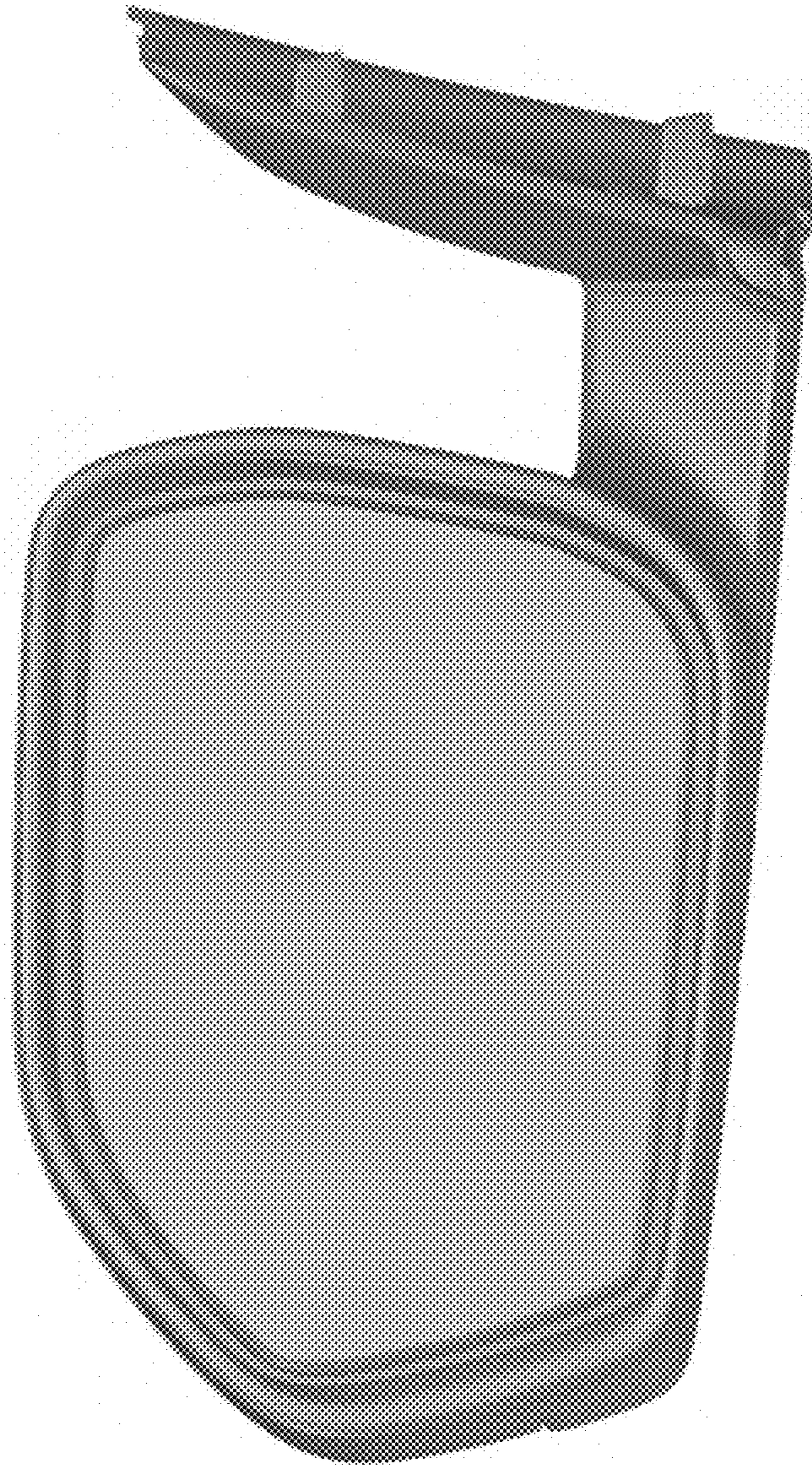

Fig. 2



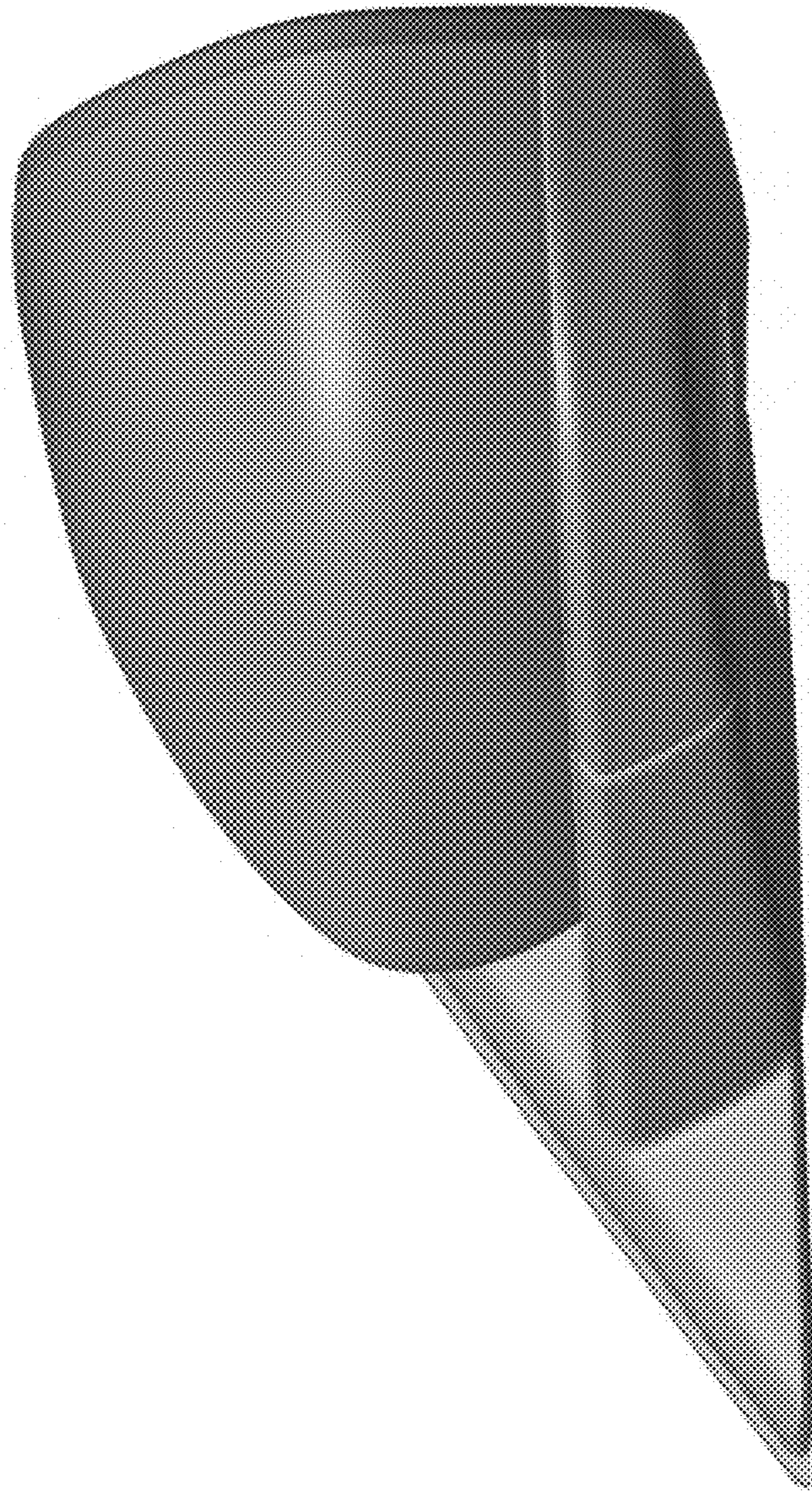

Fig. 3



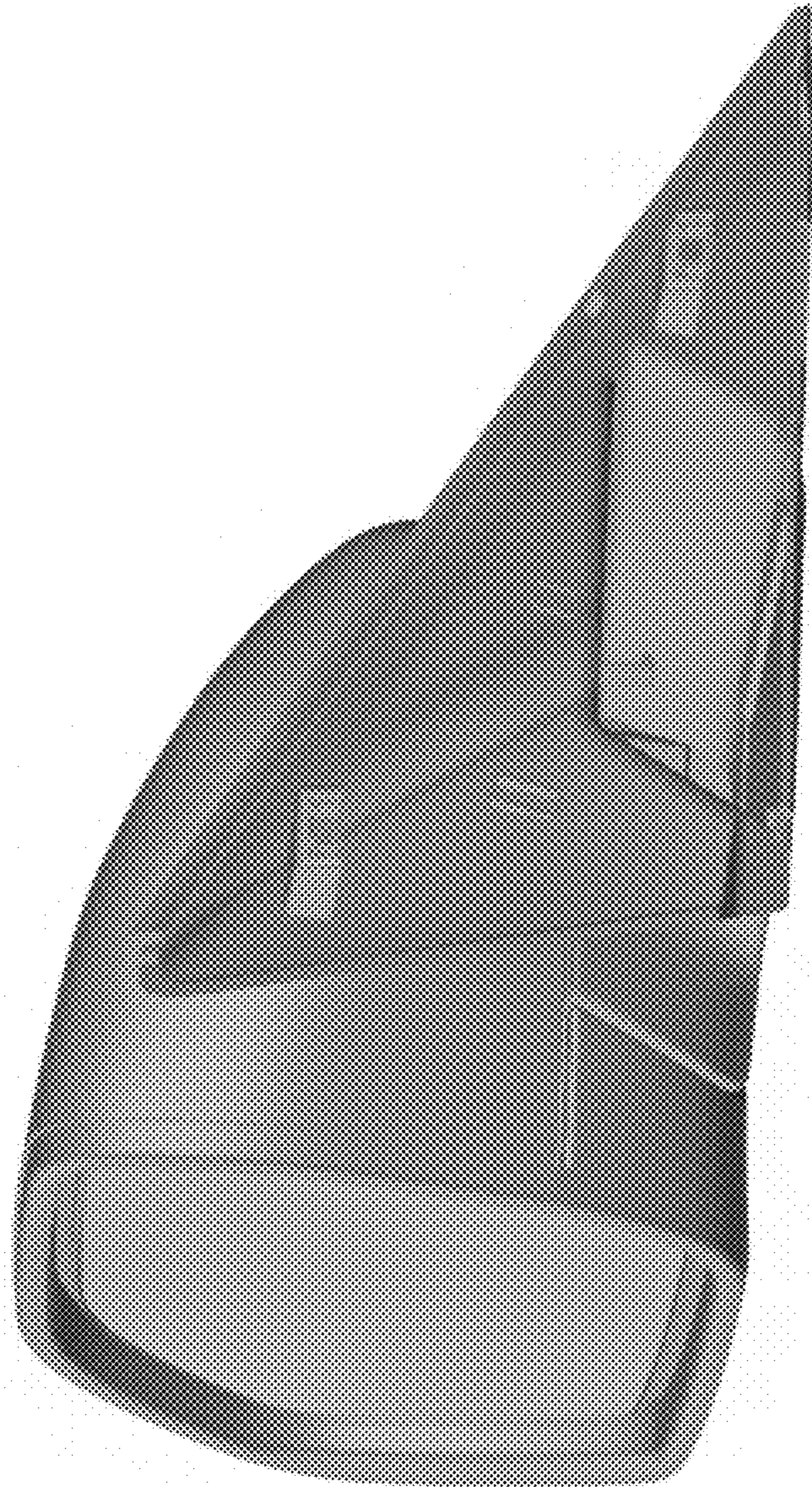

Fig. 4





Fig. 5





Fig. 6



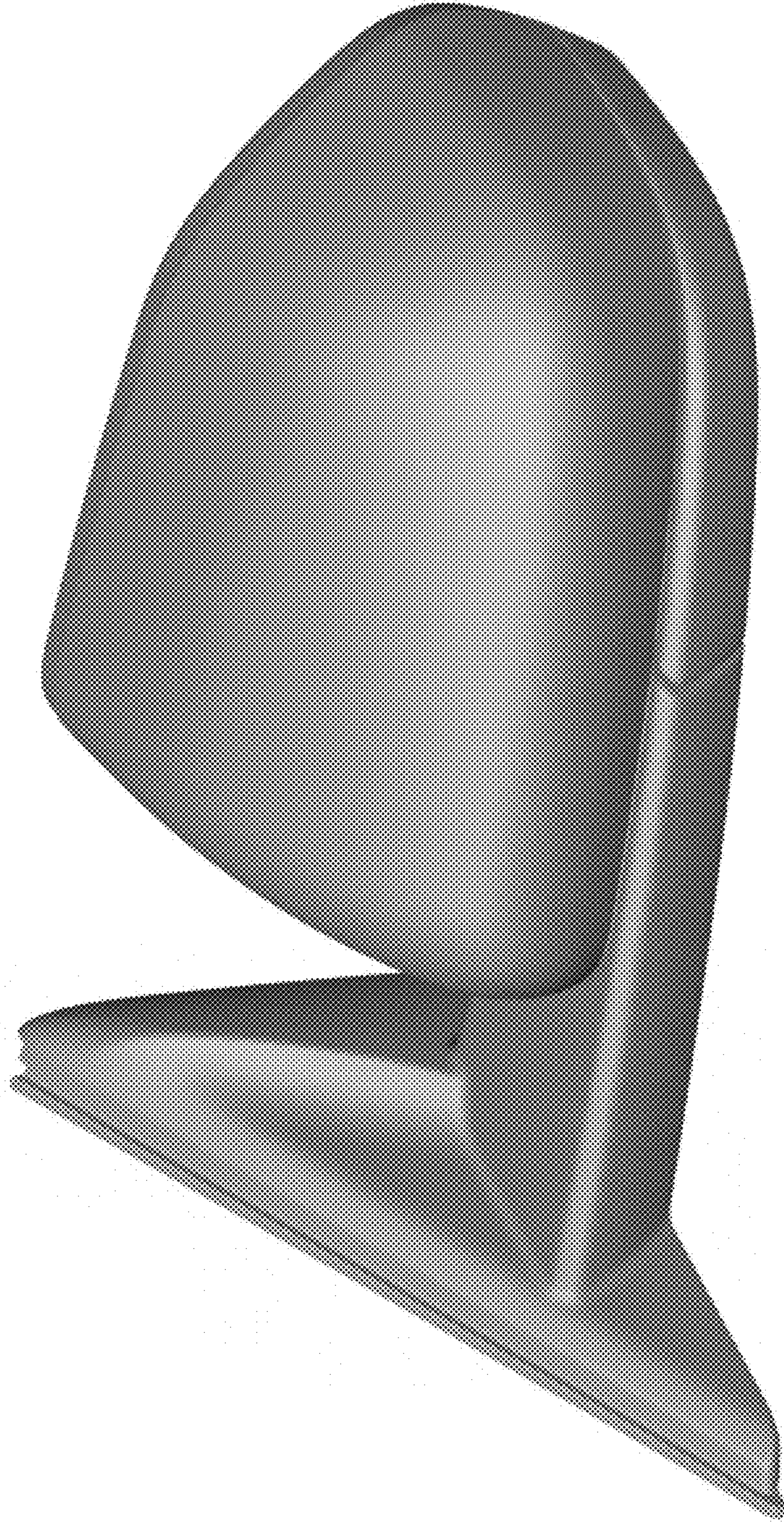

Fig. 7



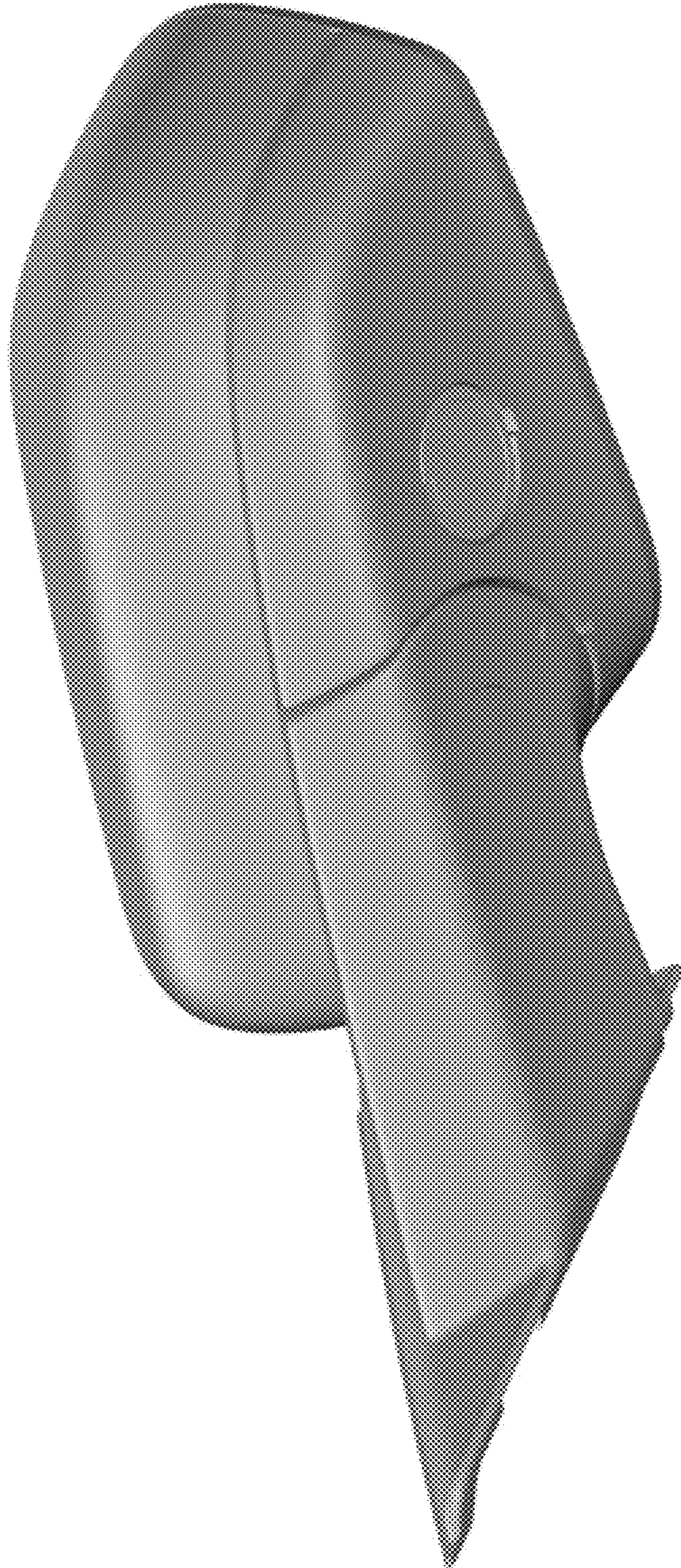

Fig. 8