



US00D942880S

(12) **United States Design Patent**
Wang

(10) **Patent No.:** **US D942,880 S**

(45) **Date of Patent:** **** Feb. 8, 2022**

(54) **CALIBRATION APPARATUS**

(71) Applicant: **AUTEL INTELLIGENT TECHNOLOGY CORP., LTD.**,
Guangdong (CN)

(72) Inventor: **Yongshuai Wang**, Guangdong (CN)

(73) Assignee: **AUTEL INTELLIGENT TECHNOLOGY CORP., LTD.**,
Shenzhen (CN)

(**) Term: **15 Years**

(21) Appl. No.: **29/732,870**

(22) Filed: **Apr. 28, 2020**

(30) **Foreign Application Priority Data**

Oct. 30, 2019 (CN) 201930593491.9

(51) **LOC (13) Cl.** **10-04**

(52) **U.S. Cl.**
USPC **D10/103**

(58) **Field of Classification Search**
USPC D10/46, 60, 70, 80, 90, 92, 94, 95, 103;
D15/122, 141, 199; D24/232
CPC G01S 7/4052; G01S 7/4008; G01S 7/4021;
G01S 7/4056; G01S 7/4972; G01S
13/931
See application file for complete search history.

(56) **References Cited**

U.S. PATENT DOCUMENTS

D658,687 S * 5/2012 Theissen D15/122
D829,575 S * 10/2018 Neto D10/67

D863,079 S * 10/2019 Cai D10/65
D883,119 S * 5/2020 Cai D10/103
D883,120 S * 5/2020 Cai D10/103
D883,121 S * 5/2020 Cai D10/103
D883,122 S * 5/2020 Cai D10/103
D883,123 S * 5/2020 Cai D10/103
D896,288 S * 9/2020 Jiang D15/122
D899,471 S * 10/2020 Liu D15/122
10,794,996 B2 * 10/2020 Qiu G01S 7/4056
10,821,607 B2 * 11/2020 Chen B66F 9/24
10,921,426 B2 * 2/2021 Tang G01S 7/40
11,002,574 B2 * 5/2021 Qiu G01D 18/00

* cited by examiner

Primary Examiner — Michael C Stout
Assistant Examiner — Fritzgerald L Butac

(57) **CLAIM**

The ornamental design for a calibration apparatus, as shown and described.

DESCRIPTION

FIG. 1 is a front elevational view of a calibration apparatus showing my new design;
FIG. 2 is a rear elevational view thereof;
FIG. 3 is a left side elevational view thereof;
FIG. 4 is a right side elevational view thereof;
FIG. 5 is a top plan view thereof;
FIG. 6 is a bottom plan view thereof; and,
FIG. 7 is a perspective view thereof.
The broken lines show portions of a calibration apparatus which form no part of the claimed design.

1 Claim, 4 Drawing Sheets

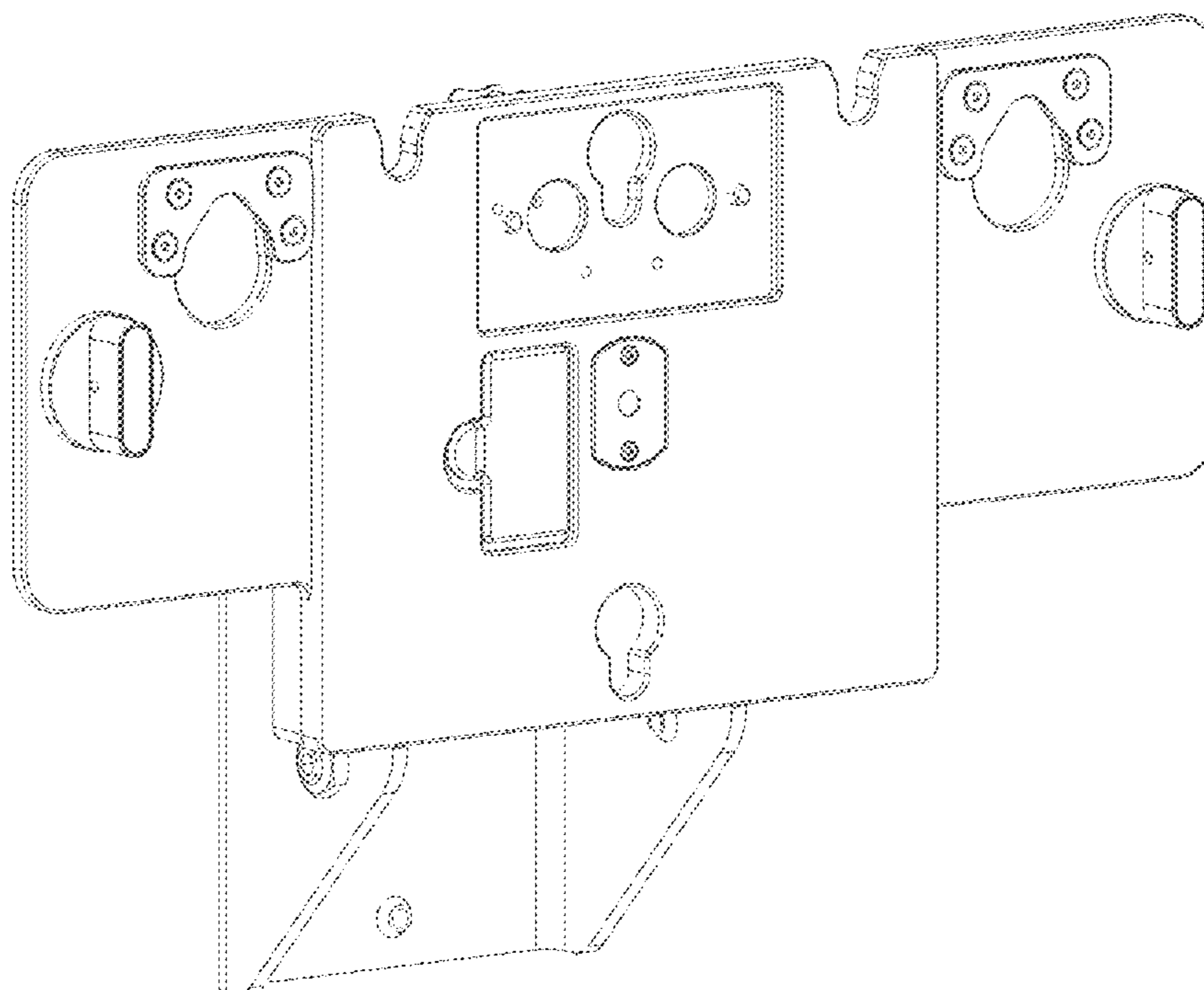

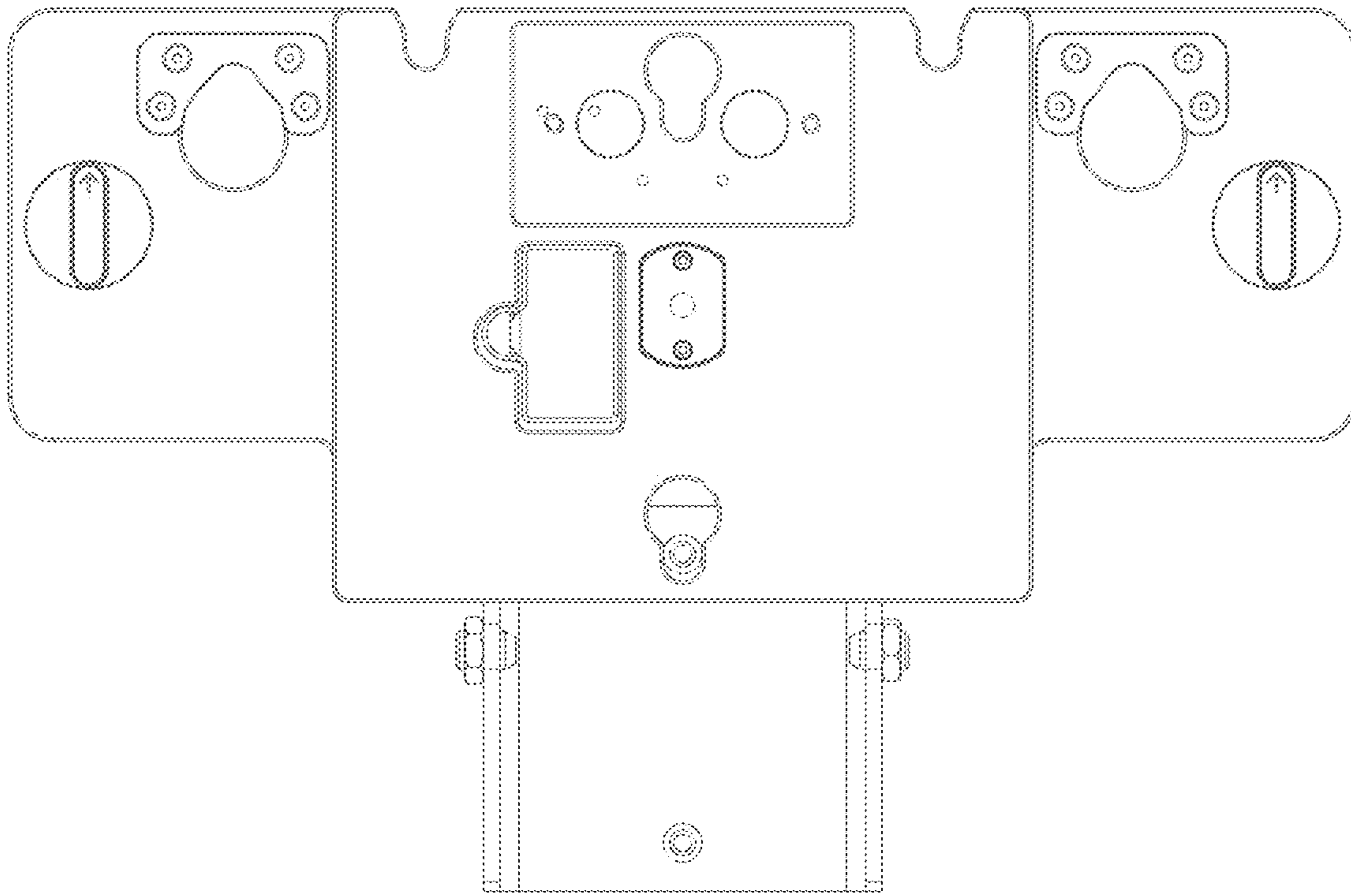

FIG.1

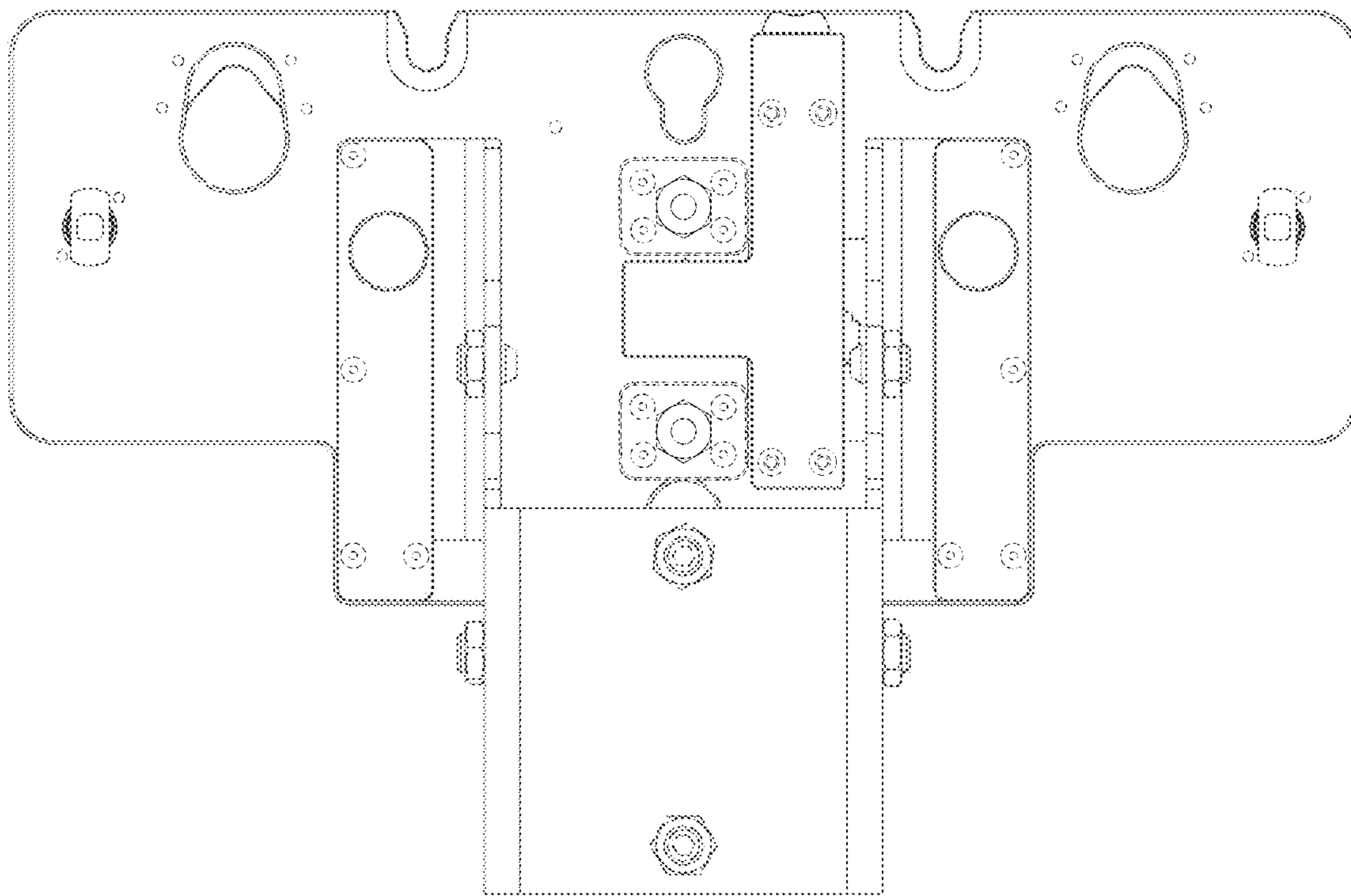

FIG.2

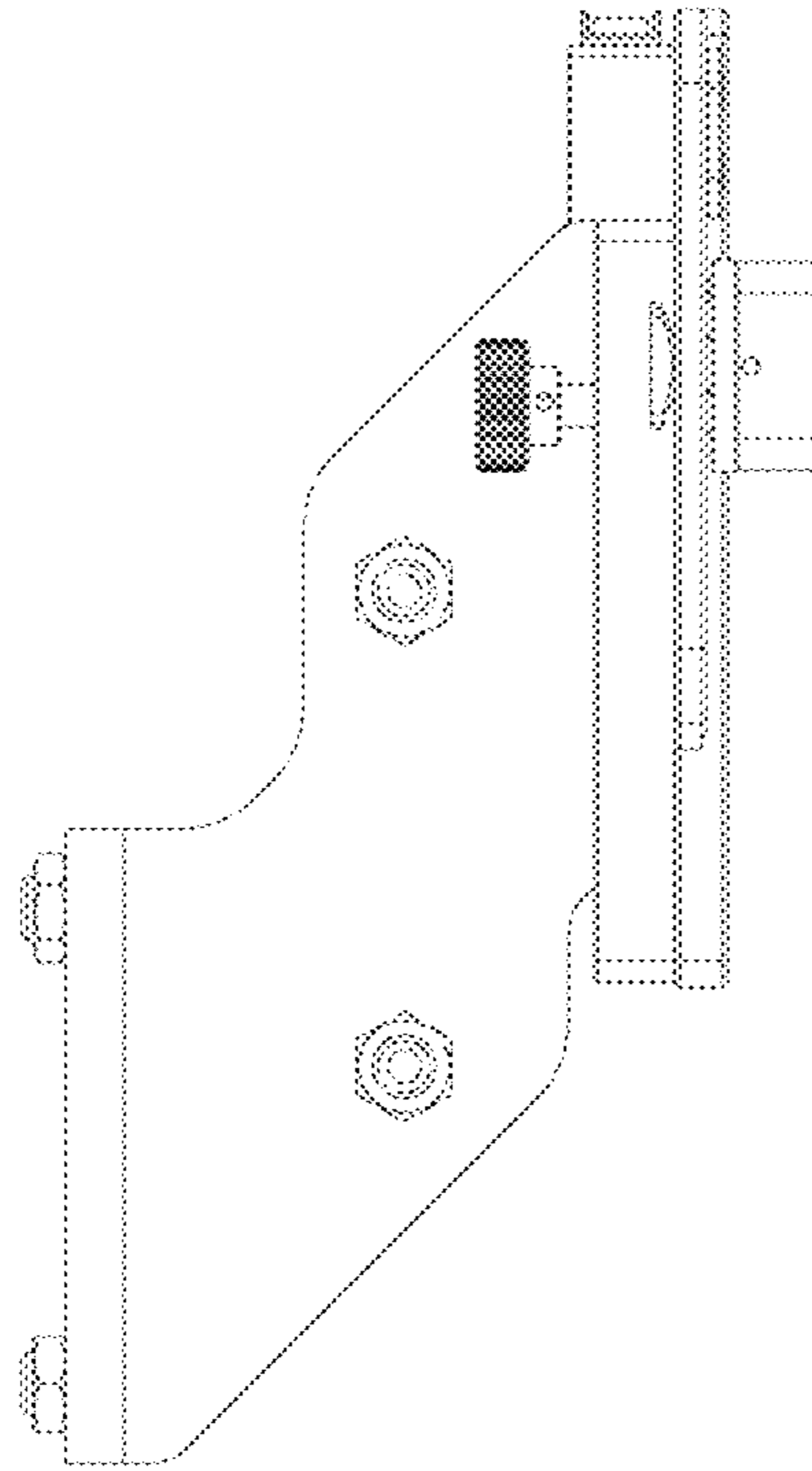

FIG.3

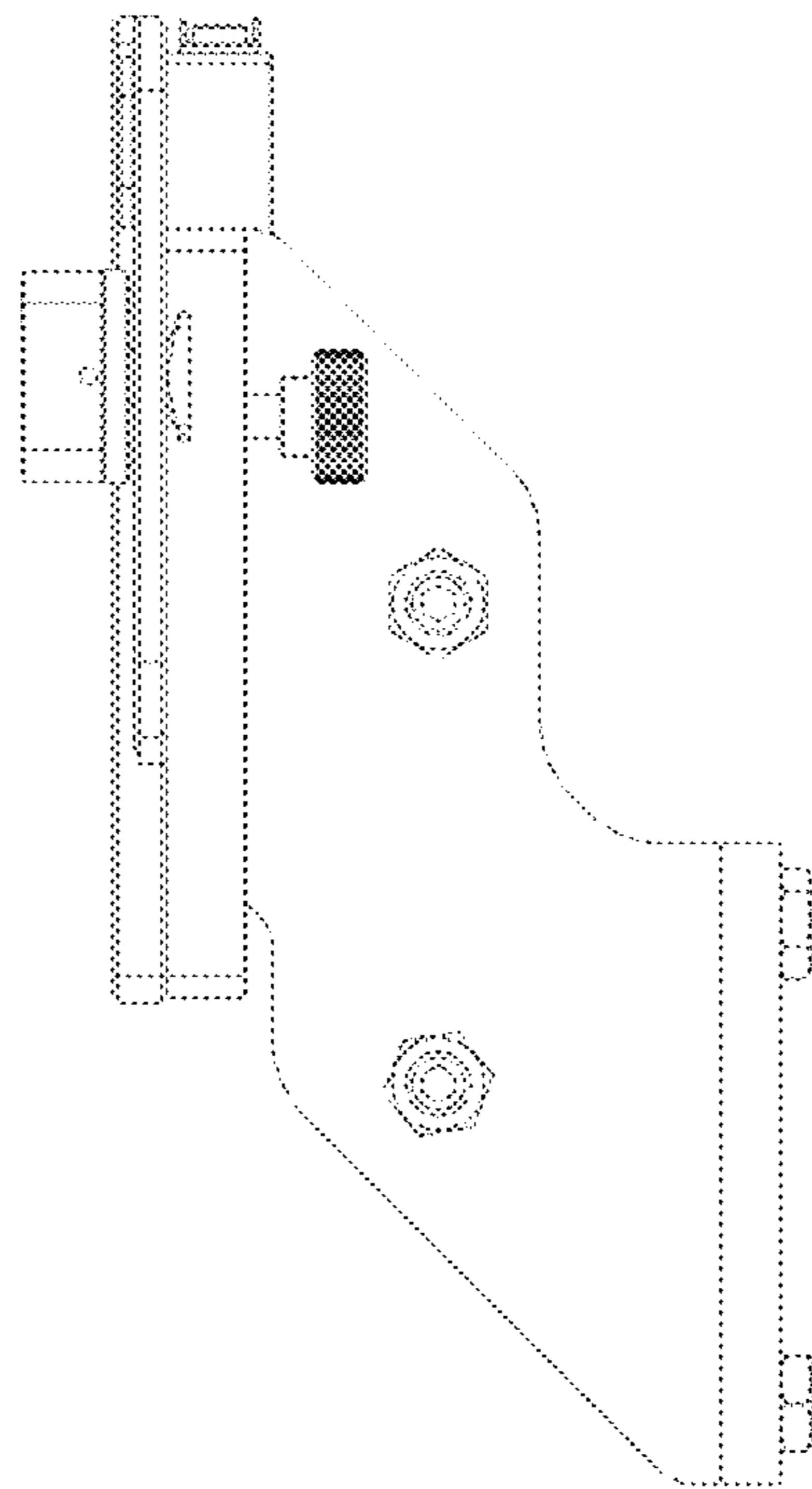

FIG.4

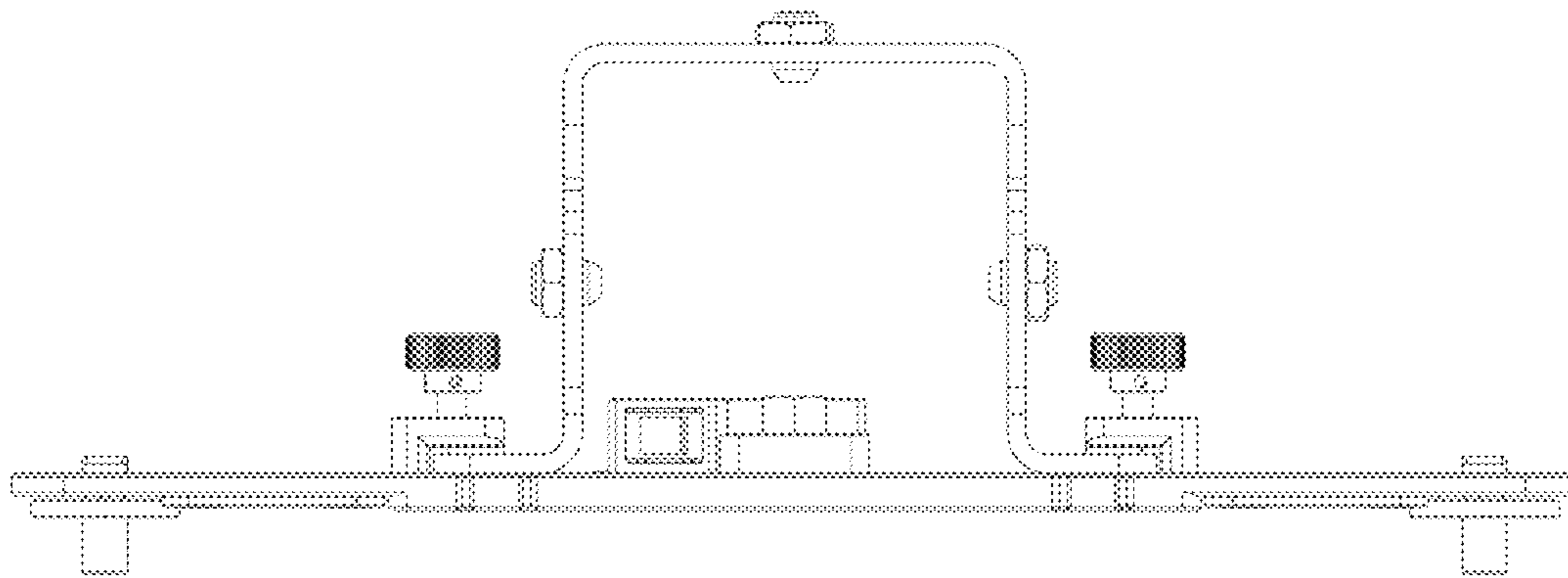

FIG. 5

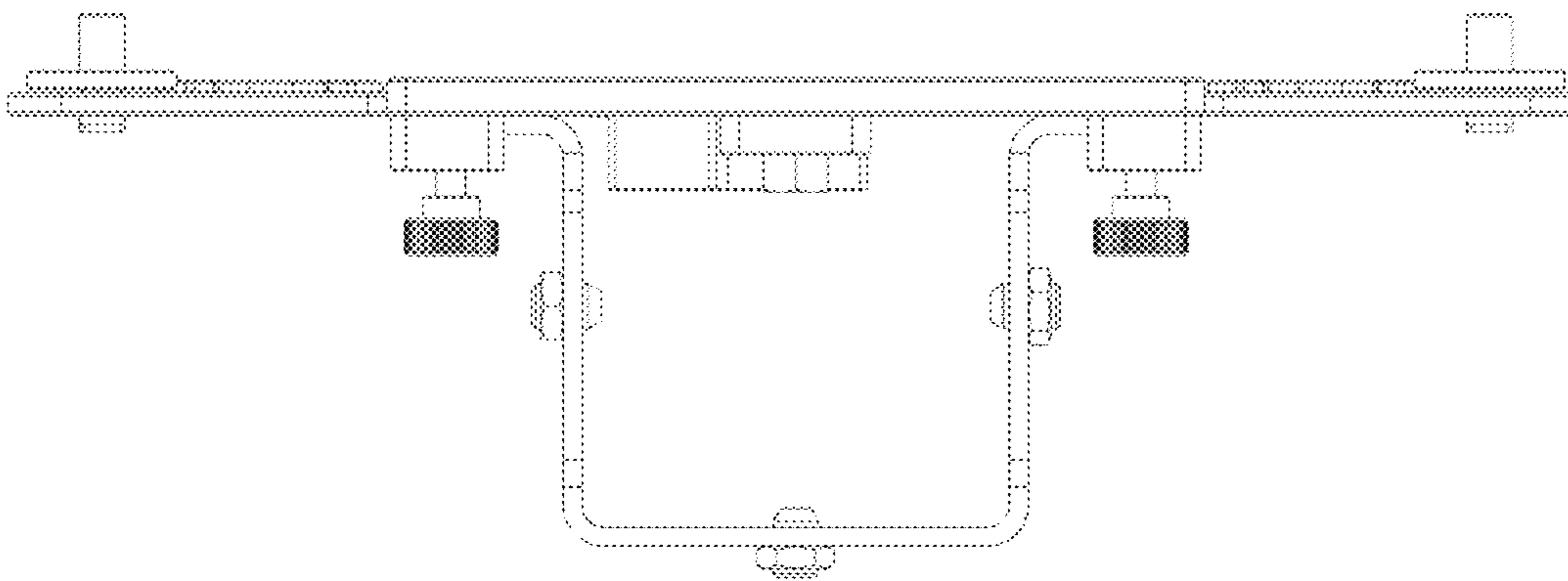

FIG. 6

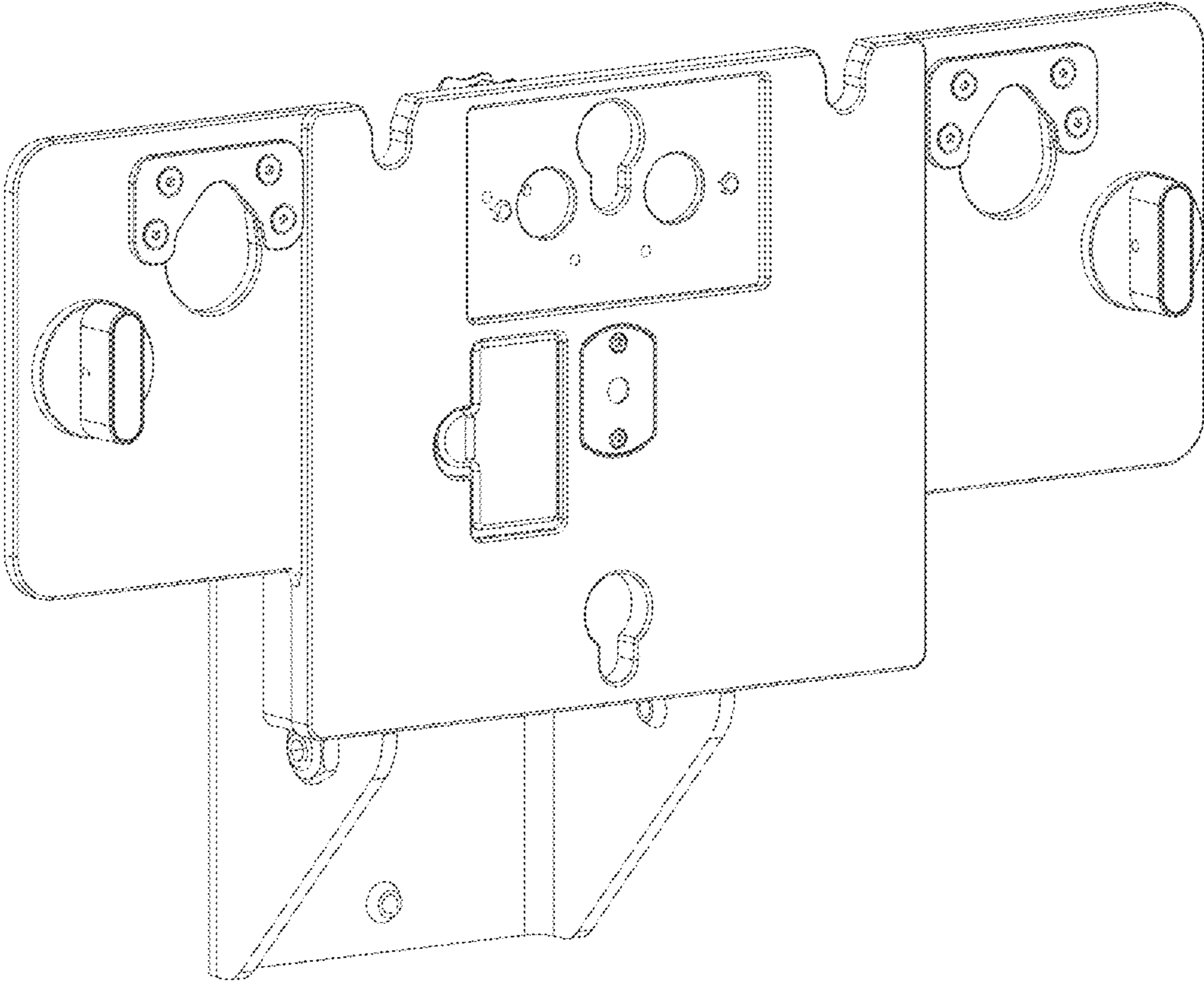

FIG.7