



US00D942858S

(12) **United States Design Patent** (10) **Patent No.:** **US D942,858 S**
Chen et al. (45) **Date of Patent:** **** Feb. 8, 2022**

(54) **CONTAINER**

- (71) Applicant: **Conopco, Inc.**, Englewood Cliffs, NJ (US)
- (72) Inventors: **Weiqing Chen**, Shanghai (CN);
Thomas Peter Gilbert, Singapore (SG)
- (73) Assignee: **Conopco, Inc.**, Englewood Cliffs, NJ (US)
- (**) Term: **15 Years**
- (21) Appl. No.: **29/731,211**
- (22) Filed: **Apr. 13, 2020**

Related U.S. Application Data

- (62) Division of application No. 29/697,681, filed on Jul. 10, 2019, now Pat. No. Des. 885,190, which is a division of application No. 29/598,507, filed on Mar. 27, 2017, now Pat. No. Des. 855,466.

(30) **Foreign Application Priority Data**

Sep. 30, 2016 (EM) 003400373-0001
 Sep. 30, 2016 (EM) 003400373-0002
 Sep. 30, 2016 (EM) 003400373-0003

(51) **LOC (13) Cl.** **09-01**

(52) **U.S. Cl.**
USPC **D9/504; D9/454**

(58) **Field of Classification Search**
 USPC D9/434-435, 444-445, 449, 454, 500,
 D9/503-504, 516, 520, 529, 549, 558,
 D9/715; D3/202, 203.2, 302; D7/608,
 D7/629-630; D28/4, 8, 76, 91
 CPC B65D 1/00; B65D 1/02; B65D 1/0223;
 B65D 23/00; B65D 81/00; B65D
 2501/00; B65D 2501/0009

See application file for complete search history.

(56) **References Cited**

U.S. PATENT DOCUMENTS

D20,336 S	11/1890	Whilldin
D24,991 S	12/1895	Estes
D114,460 S	4/1939	Platt
D155,043 S	8/1949	Serra
D223,691 S	5/1972	Newman
D254,180 S	2/1980	Morin
4,440,181 A	4/1984	Scherer
4,703,863 A	11/1987	Kohus
D372,194 S	7/1996	Dallaire

(Continued)

OTHER PUBLICATIONS

Silky All-Day Moisturizing Facial Cream; Herborist Silky All-Day Moisturizing Facial Cream; 1.

(Continued)

Primary Examiner — Dana Meyrow

(74) *Attorney, Agent, or Firm* — Gerard J. McGowan, Jr.

(57) **CLAIM**

The ornamental design for a container, as shown and described.

DESCRIPTION

The file of this patent contains at least one drawing/photograph executed in color. Copies of this patent with color drawing(s)/photograph(s) will be provided by the Office upon request and payment of the necessary fee.

FIG. 1 is a perspective view of a container showing our new design;

FIG. 2 is a front elevation view thereof;

FIG. 3 is a rear elevation view thereof;

FIG. 4 is a side elevation view thereof;

FIG. 5 is an opposing side elevation view thereof; and,

FIG. 6 is a top plan view thereof.

1 Claim, 4 Drawing Sheets
(4 of 4 Drawing Sheet(s) Filed in Color)

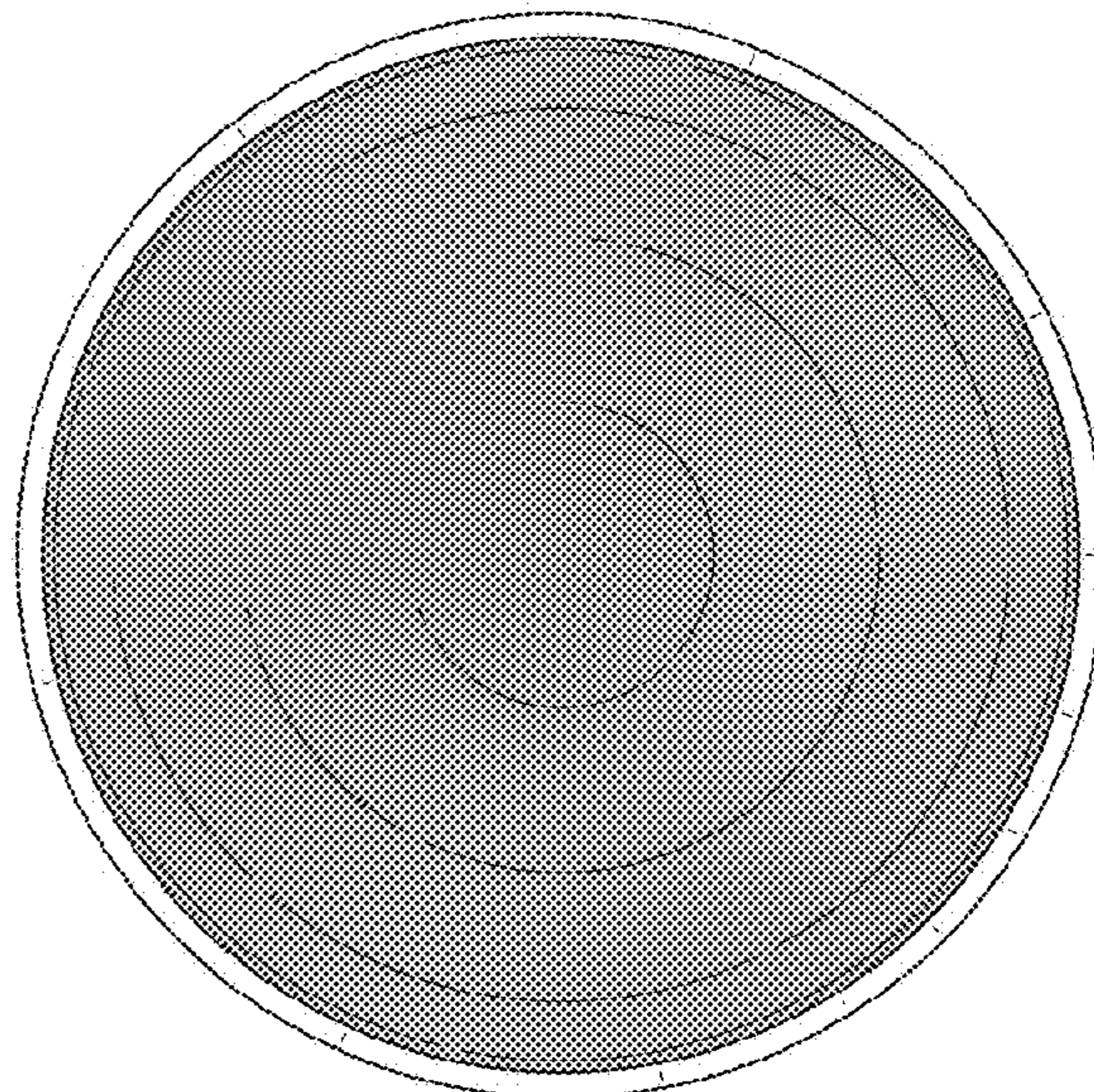
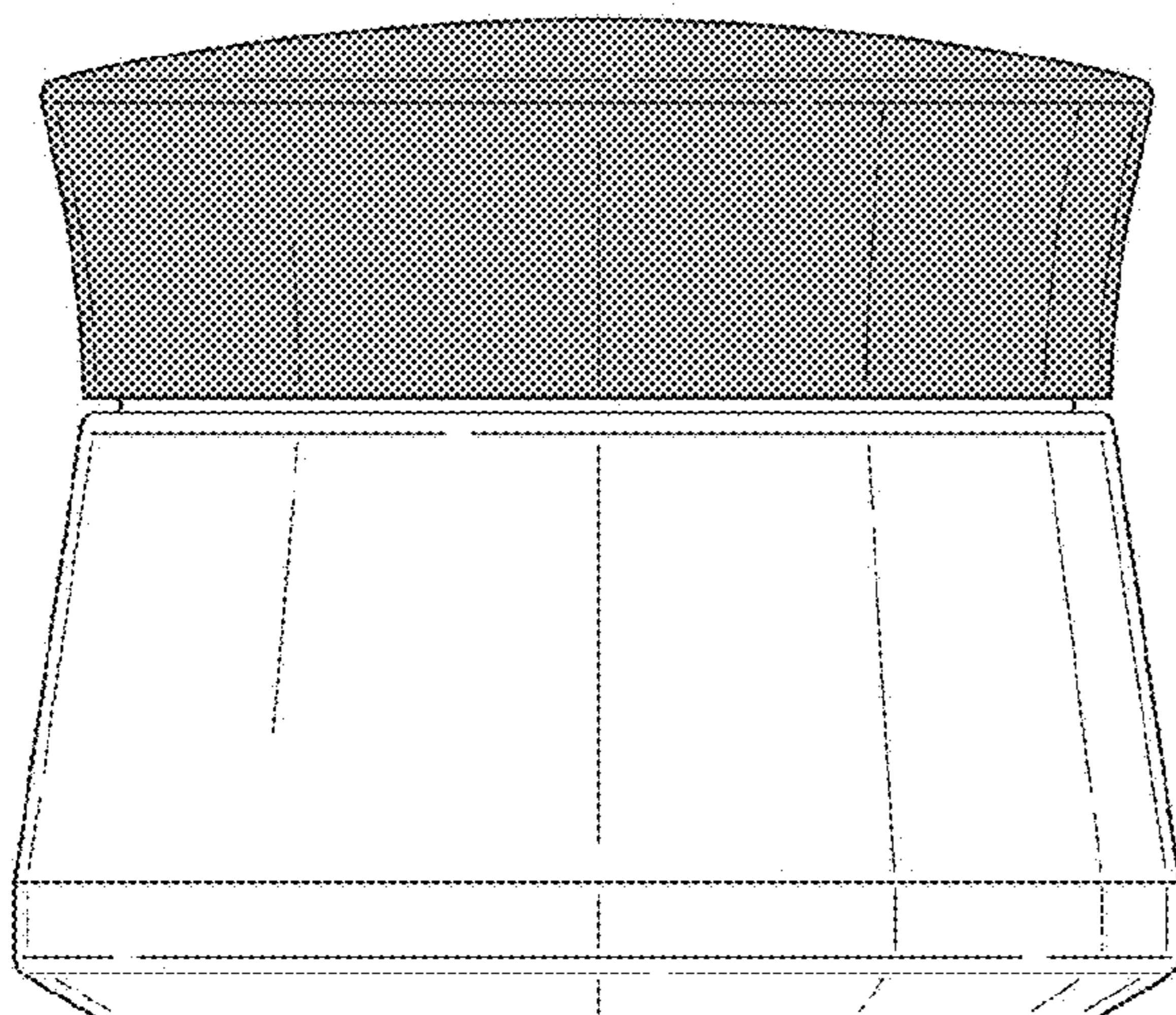

(56)

References Cited

U.S. PATENT DOCUMENTS

D373,084 S 8/1996 Choi
 D405,699 S 2/1999 Chae
 D446,456 S 8/2001 Adachi et al.
 D474,341 S 5/2003 Cantone et al.
 D505,074 S 5/2005 Bakic
 D509,434 S 9/2005 Haruta
 D512,914 S 12/2005 Moretti
 D524,161 S 7/2006 Sauer et al.
 D530,572 S 10/2006 Daams
 D531,041 S 10/2006 Sauer et al.
 D536,614 S 2/2007 Peterson et al.
 D539,480 S 3/2007 Kostow
 D574,710 S 8/2008 Gangrade
 D619,456 S 7/2010 Walters
 D657,675 S * 4/2012 Averill D9/454
 D662,422 S 6/2012 Avakian
 D695,116 S 12/2013 Ahn
 D699,593 S 2/2014 Boon et al.
 D702,755 S 4/2014 Bould et al.
 D716,427 S 10/2014 Lim et al.

D739,738 S 9/2015 Kawai
 D751,135 S 3/2016 Bould et al.
 D816,505 S 5/2018 Percassi
 D850,917 S 6/2019 Kuma et al.
 D850,919 S 6/2019 Kuma et al.
 D854,881 S * 7/2019 Barberi D7/393
 D855,466 S 8/2019 Chen et al.
 D885,190 S * 5/2020 Chen D9/504
 D887,845 S * 6/2020 LaPierre D9/503
 D891,928 S * 8/2020 Yeo D9/504
 D908,001 S * 1/2021 Pinard D9/454
 2011/0297704 A1 12/2011 Esteve et al.

OTHER PUBLICATIONS

Eye Cream; Herborist eye cream; 1.
 Day cream; Herborist day cream; 1.
 Silky All Day Moisturizing Eye Gel; Heborist; 1.
 Regener-activ Contorno de Ojos; Ponds; PP1-1 Eye cream pack
 from Spain.
 Day Cream & Eye Cream Range; Herborist; PP1-1 .

* cited by examiner

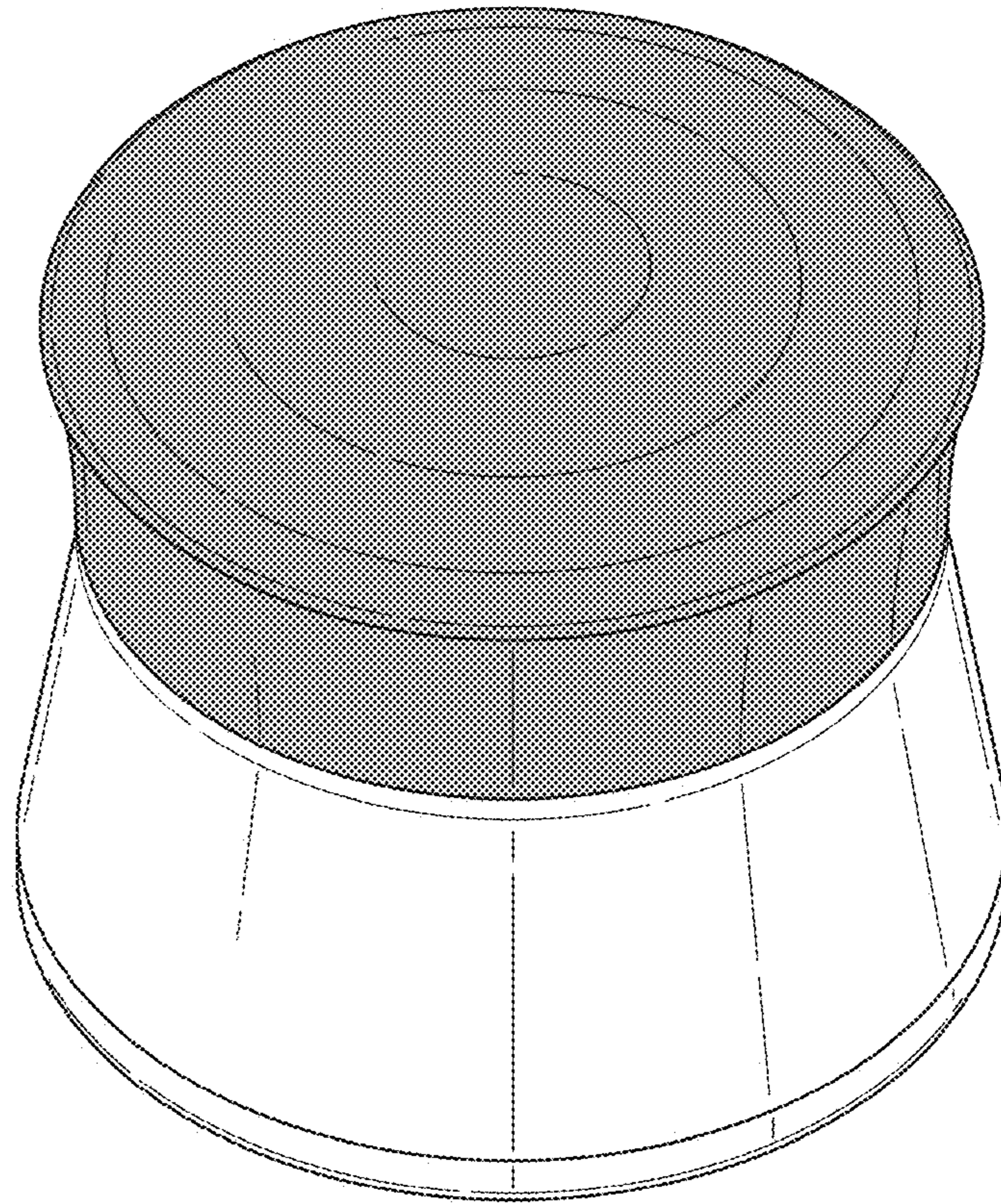

Fig. 1

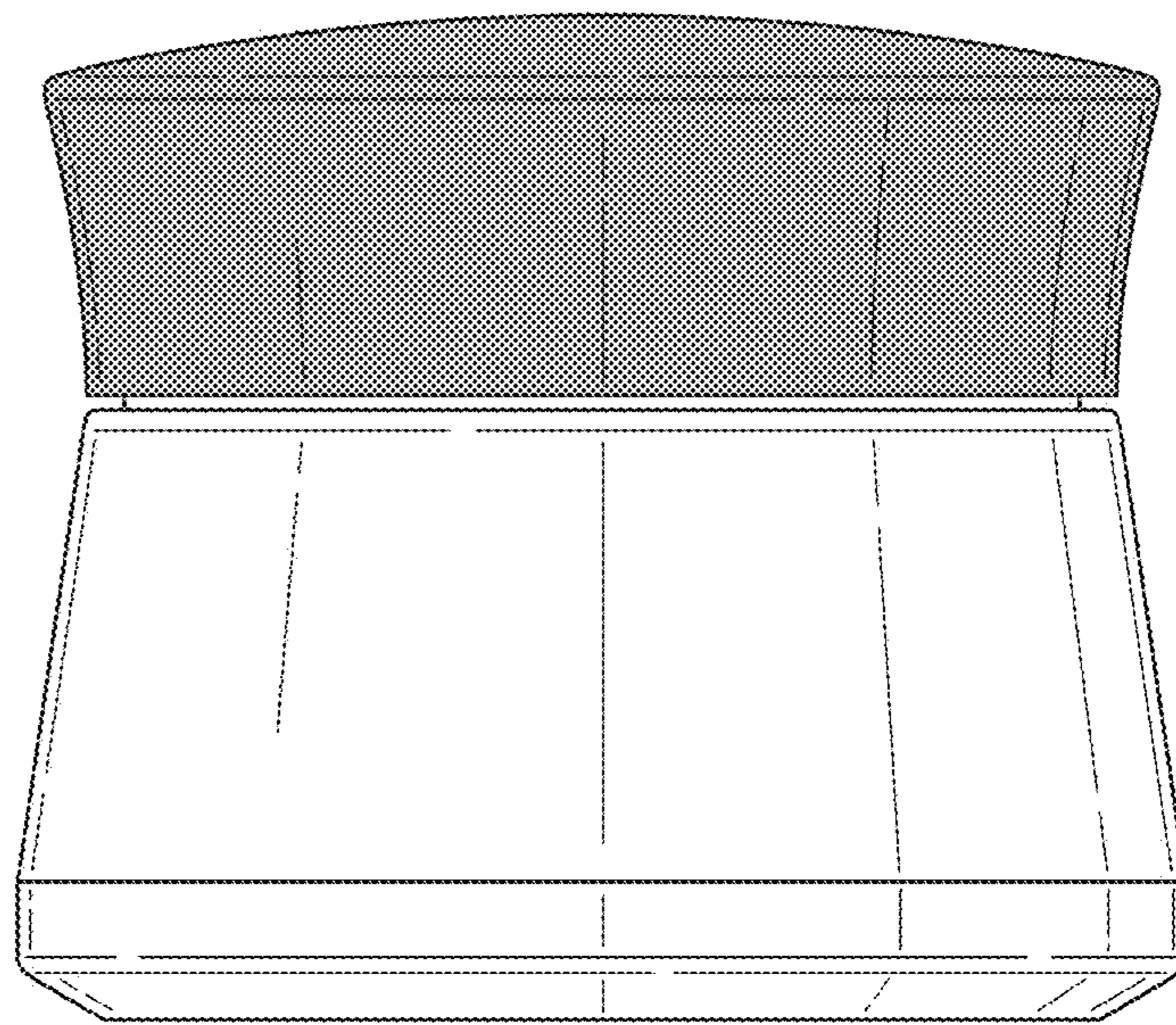

Fig. 2

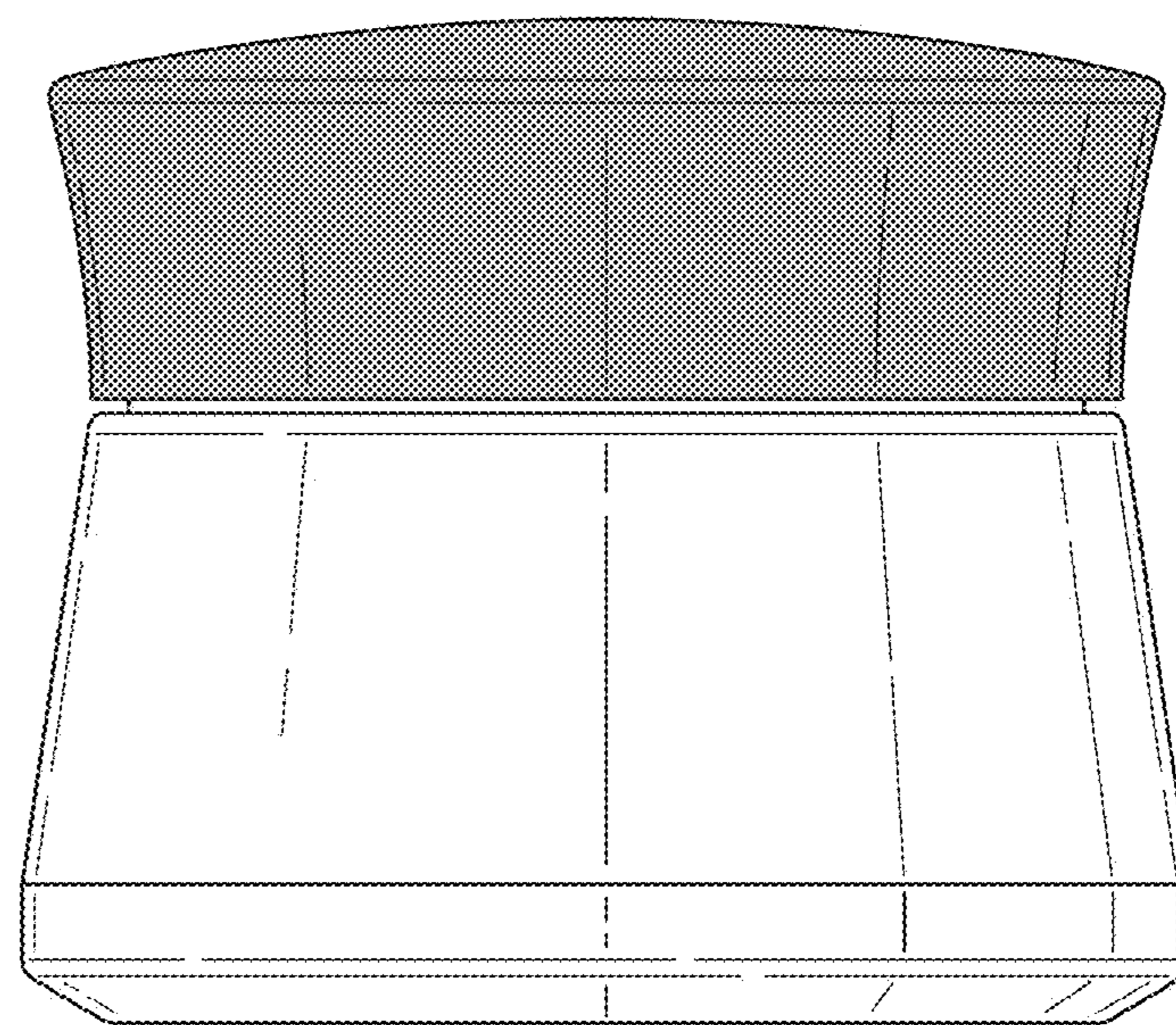

Fig. 3

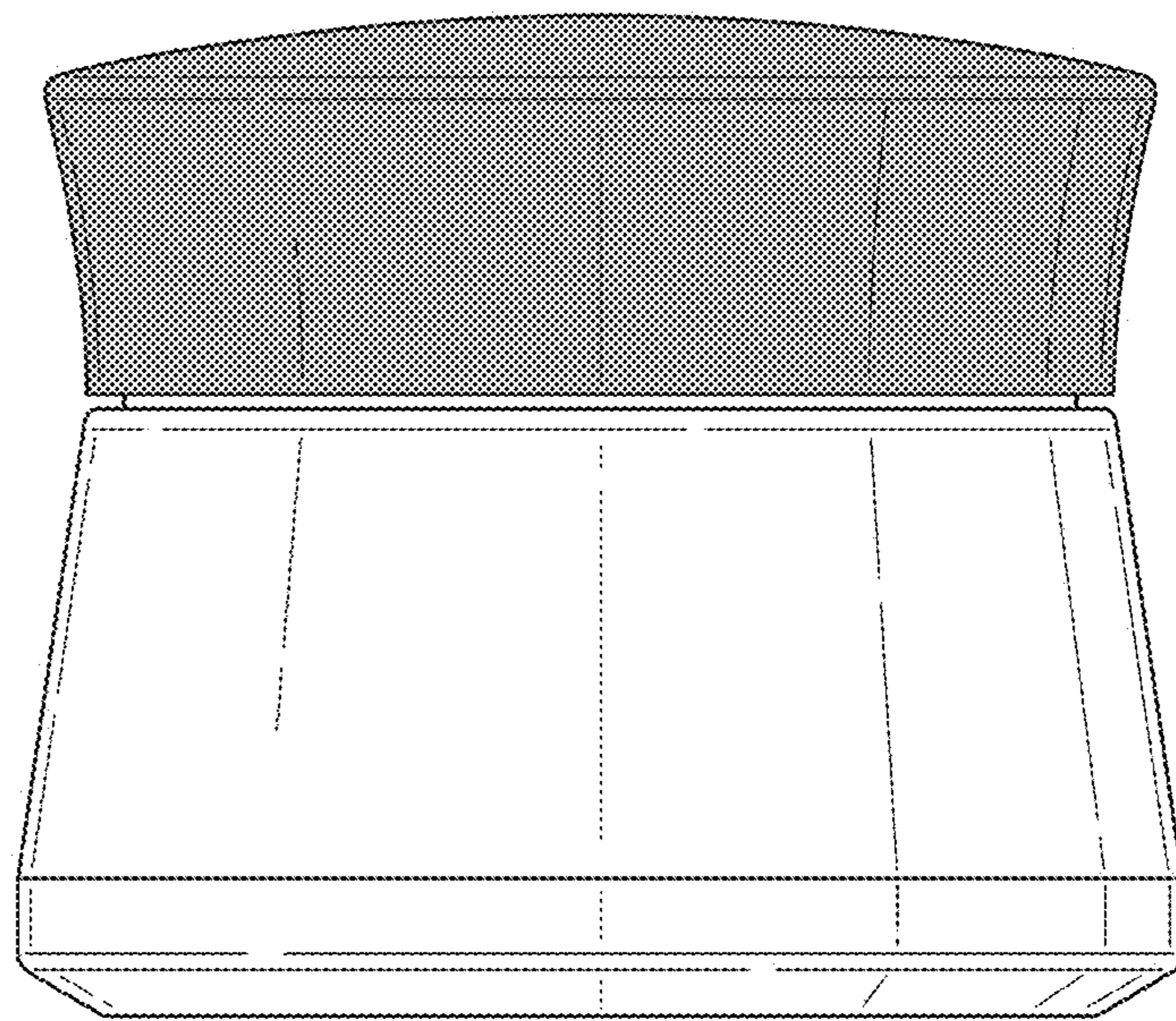

Fig. 4

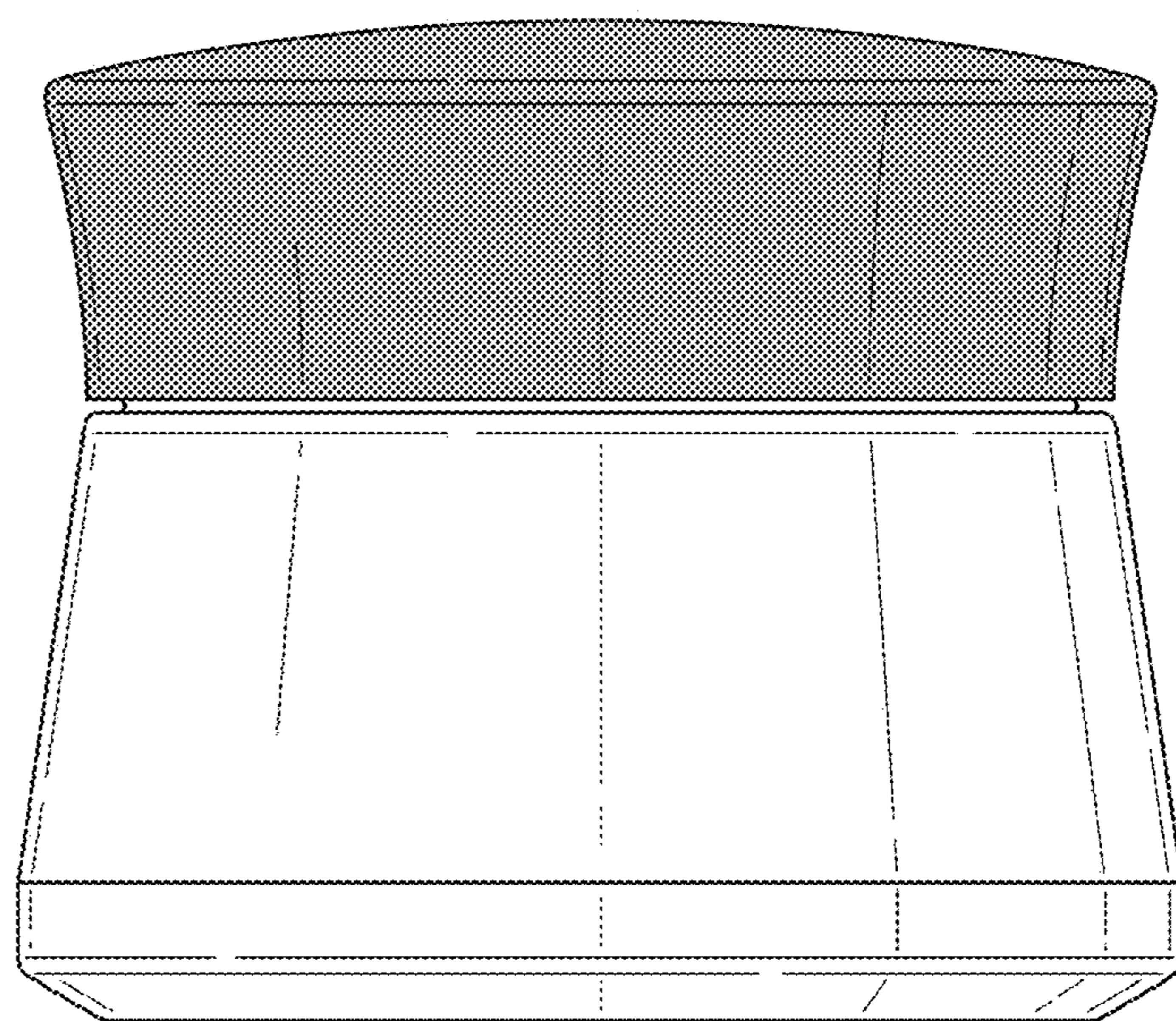

Fig. 5

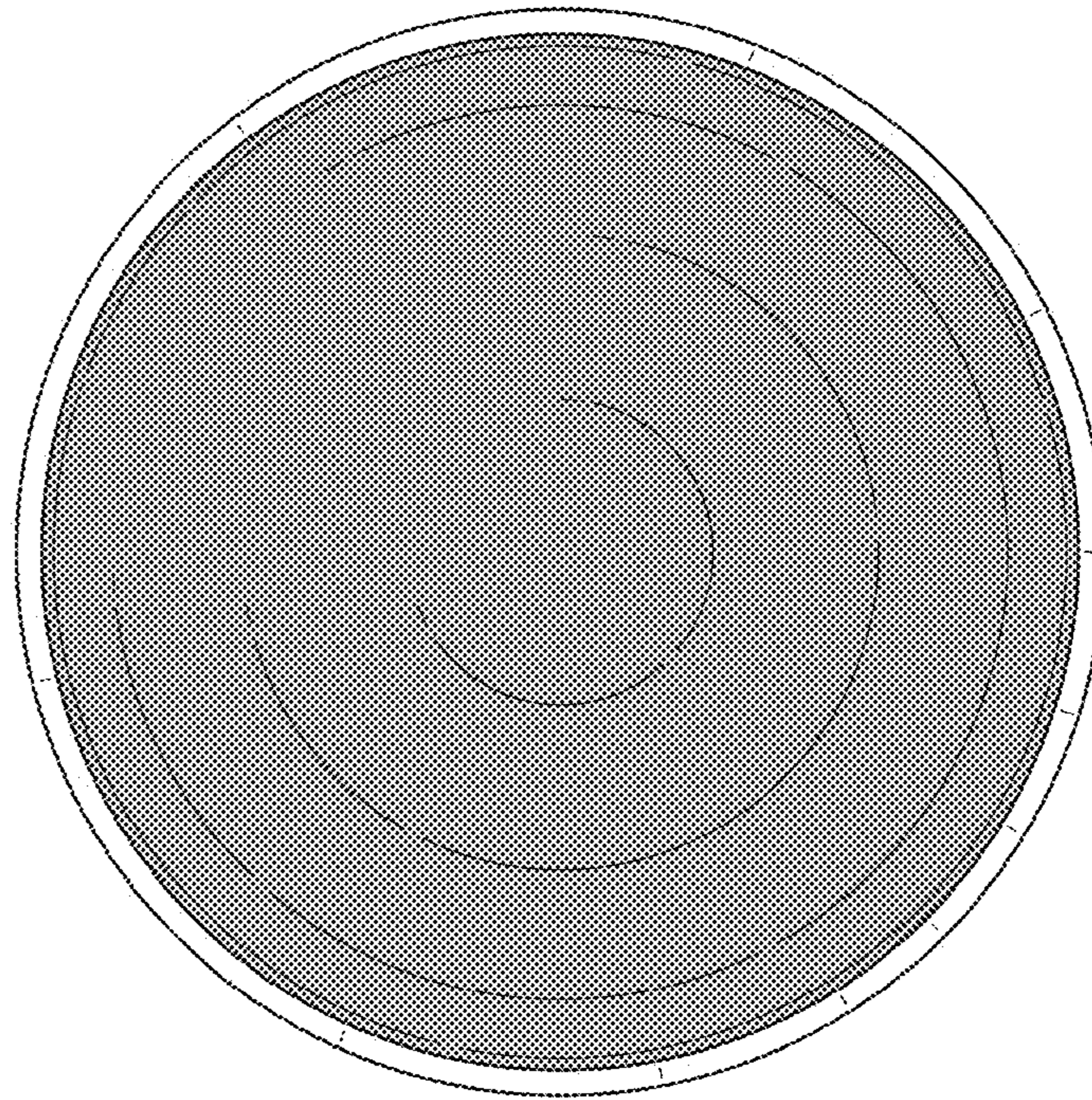

Fig. 6