



US00D942822S

(12) **United States Design Patent**  
**Kahoush**

(10) **Patent No.:** **US D942,822 S**

(45) **Date of Patent:** **\*\* Feb. 8, 2022**

- (54) **TONGS**
- (71) Applicant: **Hania Kahoush**, Bolingbrooke, IL (US)
- (72) Inventor: **Hania Kahoush**, Bolingbrooke, IL (US)
- (\*\*) Term: **15 Years**
- (21) Appl. No.: **29/716,128**
- (22) Filed: **Dec. 6, 2019**
- (51) **LOC (13) Cl.** ..... **07-06**
- (52) **U.S. Cl.**  
USPC ..... **D7/686**
- (58) **Field of Classification Search**  
USPC ..... D7/213, 372, 381, 412, 673, 683, 686,  
D7/688, 689, 691, 692, 693, 694, 695,  
D7/696  
CPC ..... A47F 13/08; A47G 21/045; A47J 43/283;  
B65D 61/246; B26D 3/26; B26B 25/005  
See application file for complete search history.

- D811,175 S 2/2018 Labbee et al.
- D826,656 S 8/2018 Loshuk
- D840,773 S \* 2/2019 Lester ..... D7/686
- D851,412 S 6/2019 Harrington et al.
- 2006/0157996 A1 7/2006 McRorie, III et al.
- 2009/0179442 A1\* 7/2009 Mithal ..... B29C 45/2708  
294/16
- 2014/0110957 A1 4/2014 Torres, Jr.
- 2014/0319862 A1\* 10/2014 Ho ..... B25B 7/02  
294/99.2

(56) **References Cited**

**U.S. PATENT DOCUMENTS**

- 2,864,645 A \* 12/1958 Meldrum ..... A47J 43/283  
294/106
- D254,767 S 4/1980 Christen, Jr.
- 5,487,578 A \* 1/1996 Williams ..... A61B 17/30  
294/99.2
- D488,032 S 4/2004 Best et al.
- D509,413 S 9/2005 Marsden et al.
- D510,845 S 10/2005 Holcomb et al.
- D557,084 S 12/2007 Yamanaka et al.
- D560,980 S \* 2/2008 LeGreve ..... D7/686
- D606,370 S 12/2009 Araiza et al.
- D610,883 S \* 3/2010 Blacken ..... D7/686
- D667,707 S 9/2012 Zemel
- D671,377 S 11/2012 Roberts
- D673,819 S 1/2013 Staib et al.
- D675,487 S 2/2013 Gross et al.
- D766,682 S 9/2016 Flournoy
- 9,662,770 B1 \* 5/2017 Gross ..... B25B 9/02

**OTHER PUBLICATIONS**

Bonanza website, Cravings by Chrissy Teigen Stainless Steel Locking Tongs with Silicone Heads, Publication date unknown, [site visited Jul. 7, 2021], Available on the Internet URL [www.bonanza.com/listings/Cravings-By-Chrissy-Teigen-Stainless-Steel-Locking-Tongs-With-Silicone-Heads/1033298546](http://www.bonanza.com/listings/Cravings-By-Chrissy-Teigen-Stainless-Steel-Locking-Tongs-With-Silicone-Heads/1033298546) (Year: 2021).\*

\* cited by examiner

*Primary Examiner* — S. Bryan Reinholdt, Jr.

(74) *Attorney, Agent, or Firm* — H. Brock Kolls

(57) **CLAIM**

The ornamental design for tongs, as shown and described.

**DESCRIPTION**

FIG. 1 is a perspective view of the tongs according to my new design; and  
FIG. 2 is a side elevation view thereof,  
FIG. 3 is a front perspective view of the lower of the two parts of the tongs of FIG. 1;  
FIG. 4 is a back perspective view thereof;  
FIG. 5 is a top plan view thereof; and,  
FIG. 6 is a bottom plan view thereof.  
The dashed lines and the areas within them shown in FIGS. 1, 2, and 4 depict portions of the tongs that form no part of the claimed design.

**1 Claim, 5 Drawing Sheets**

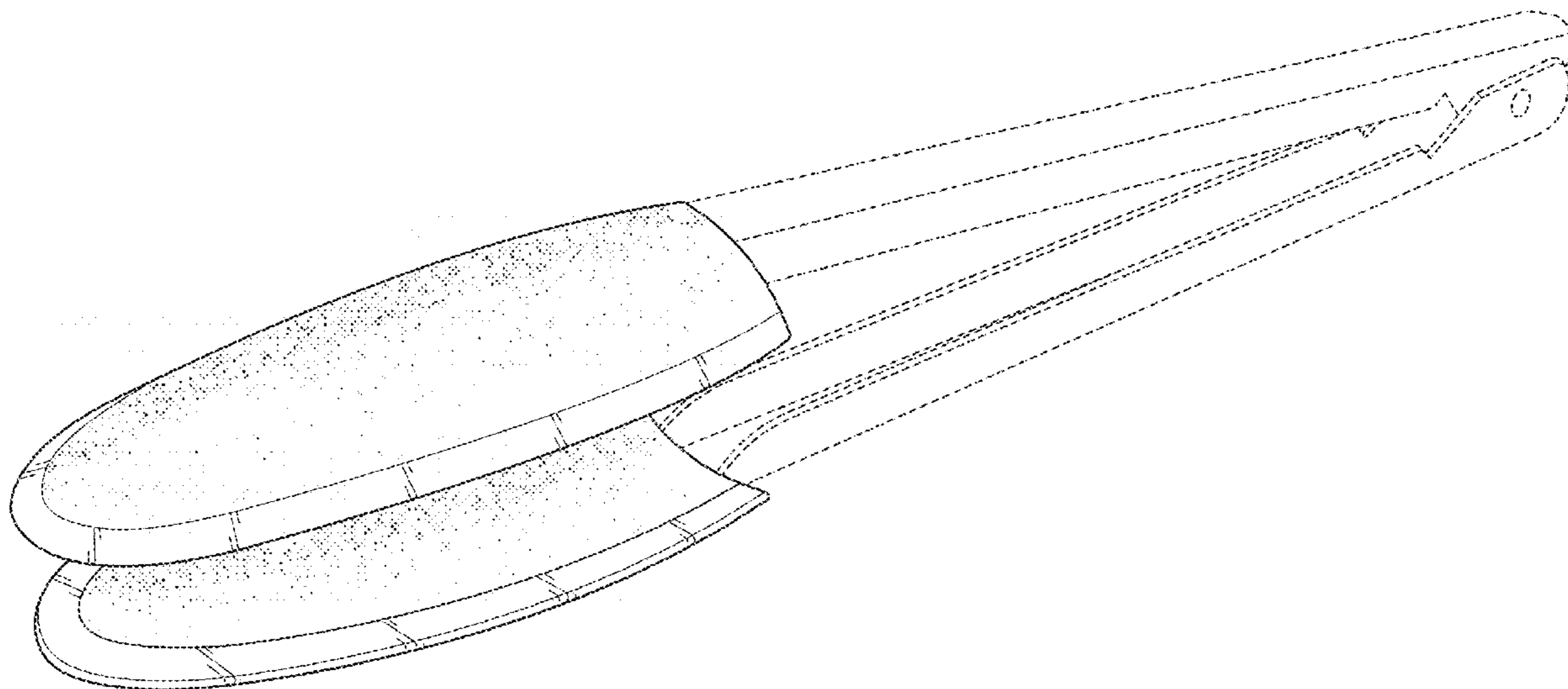

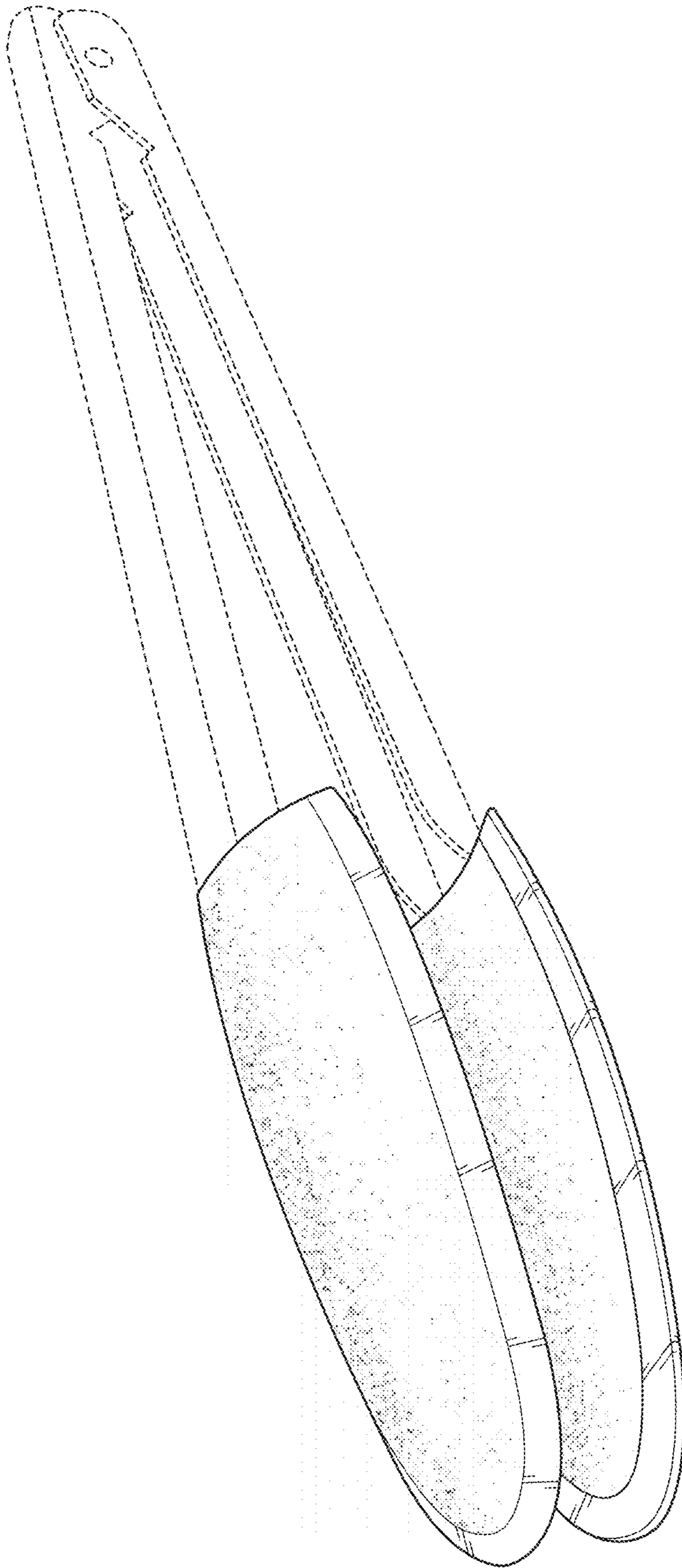

FIG. 1

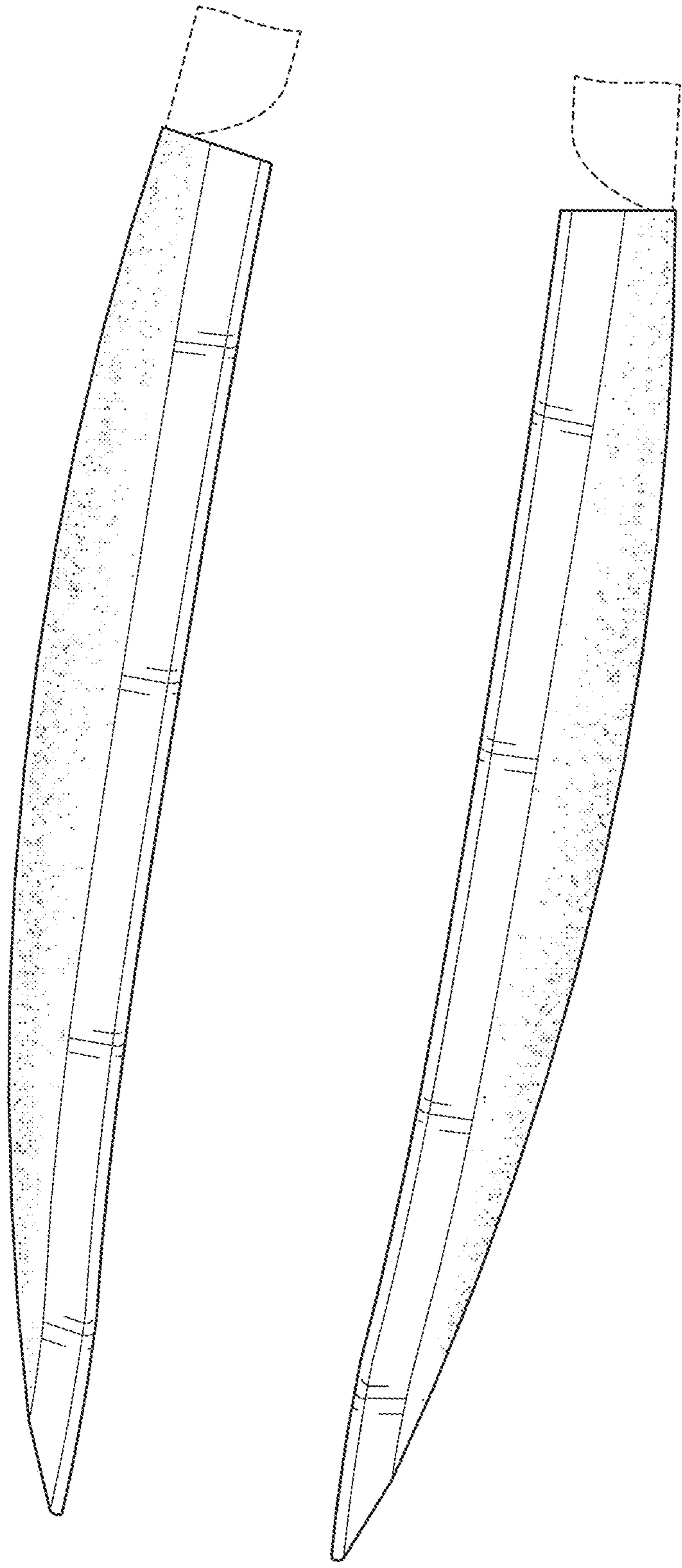

FIG. 2

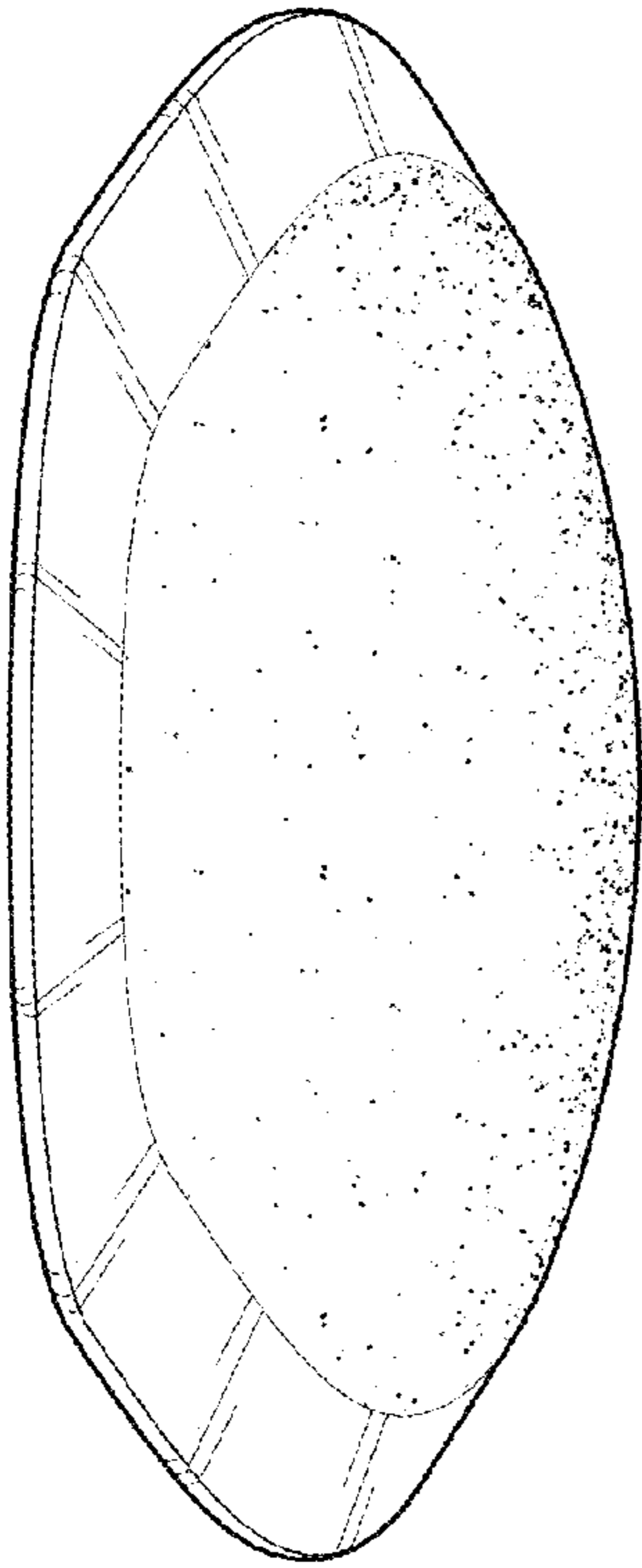

FIG. 3

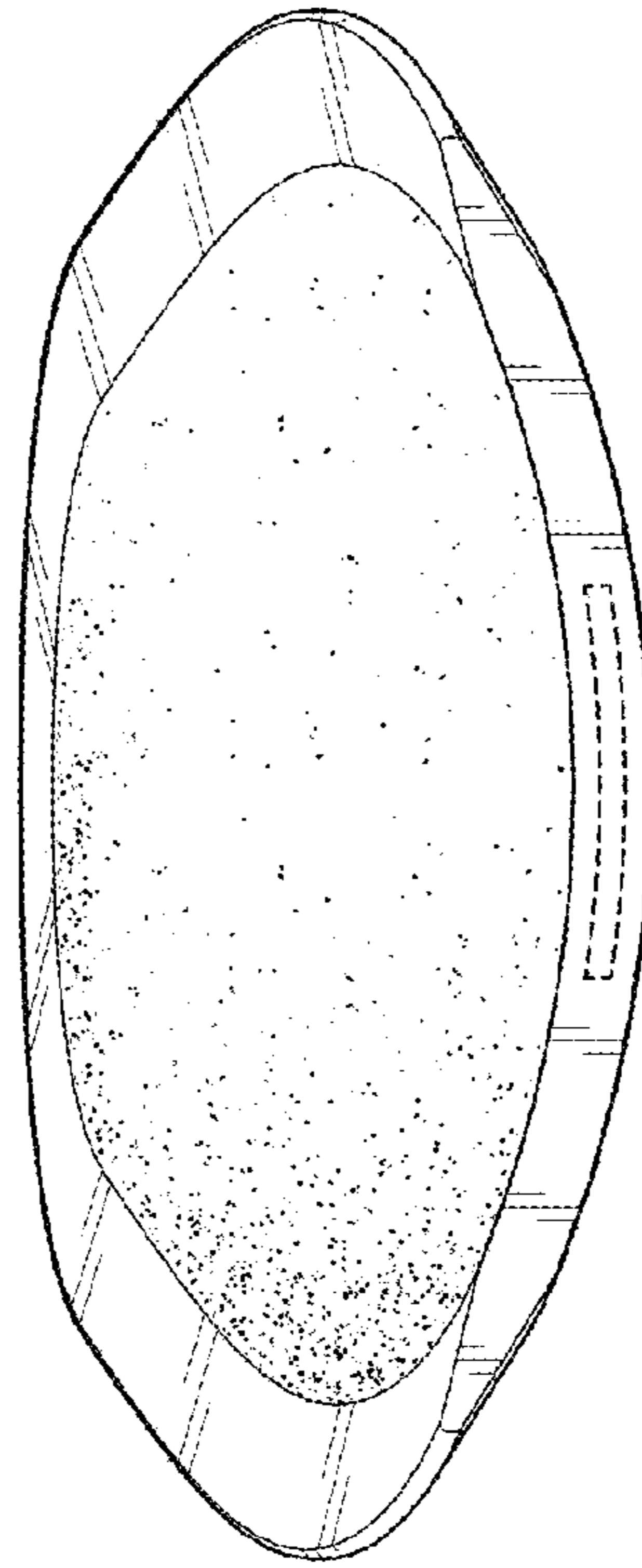

FIG. 4

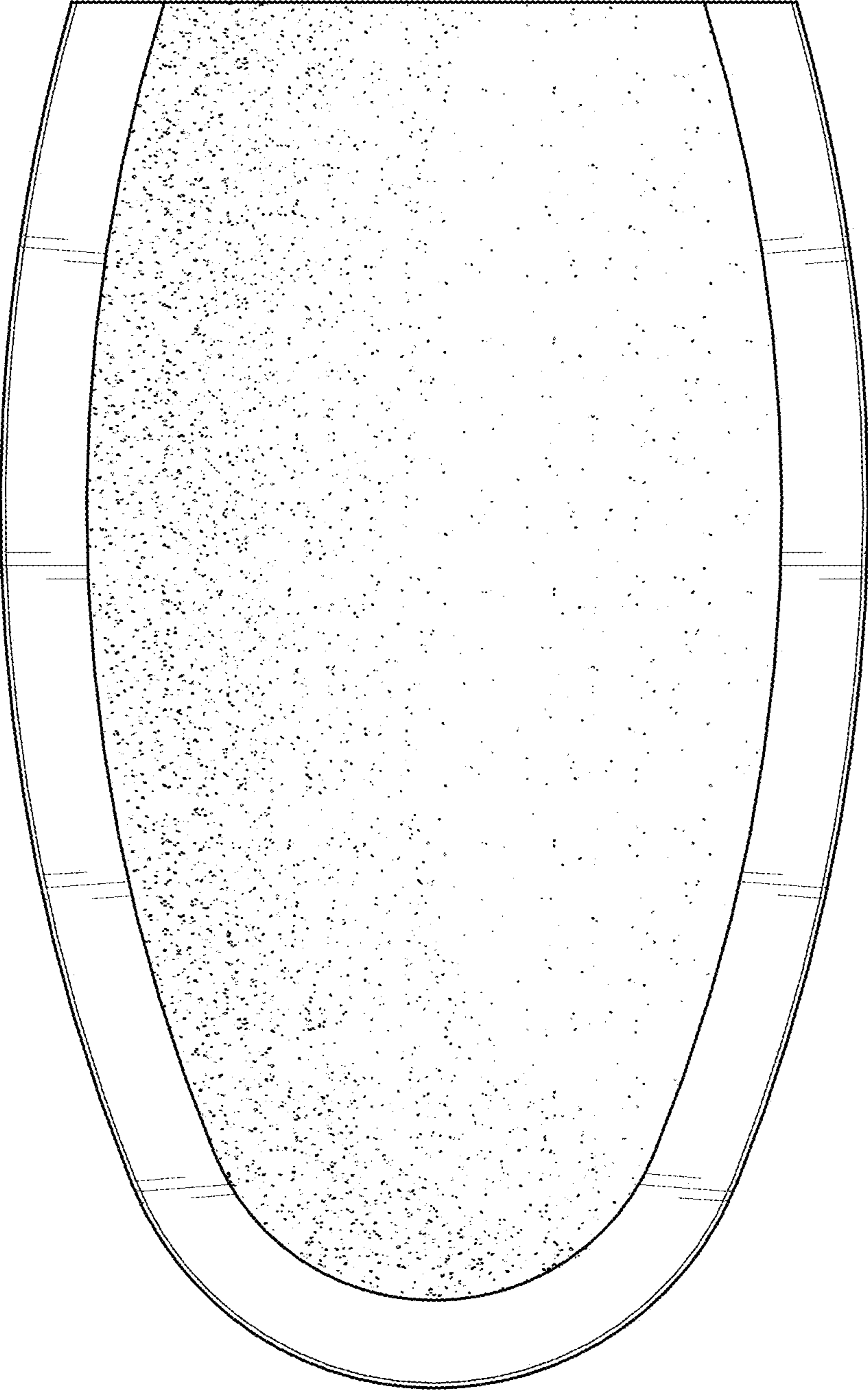

FIG. 5

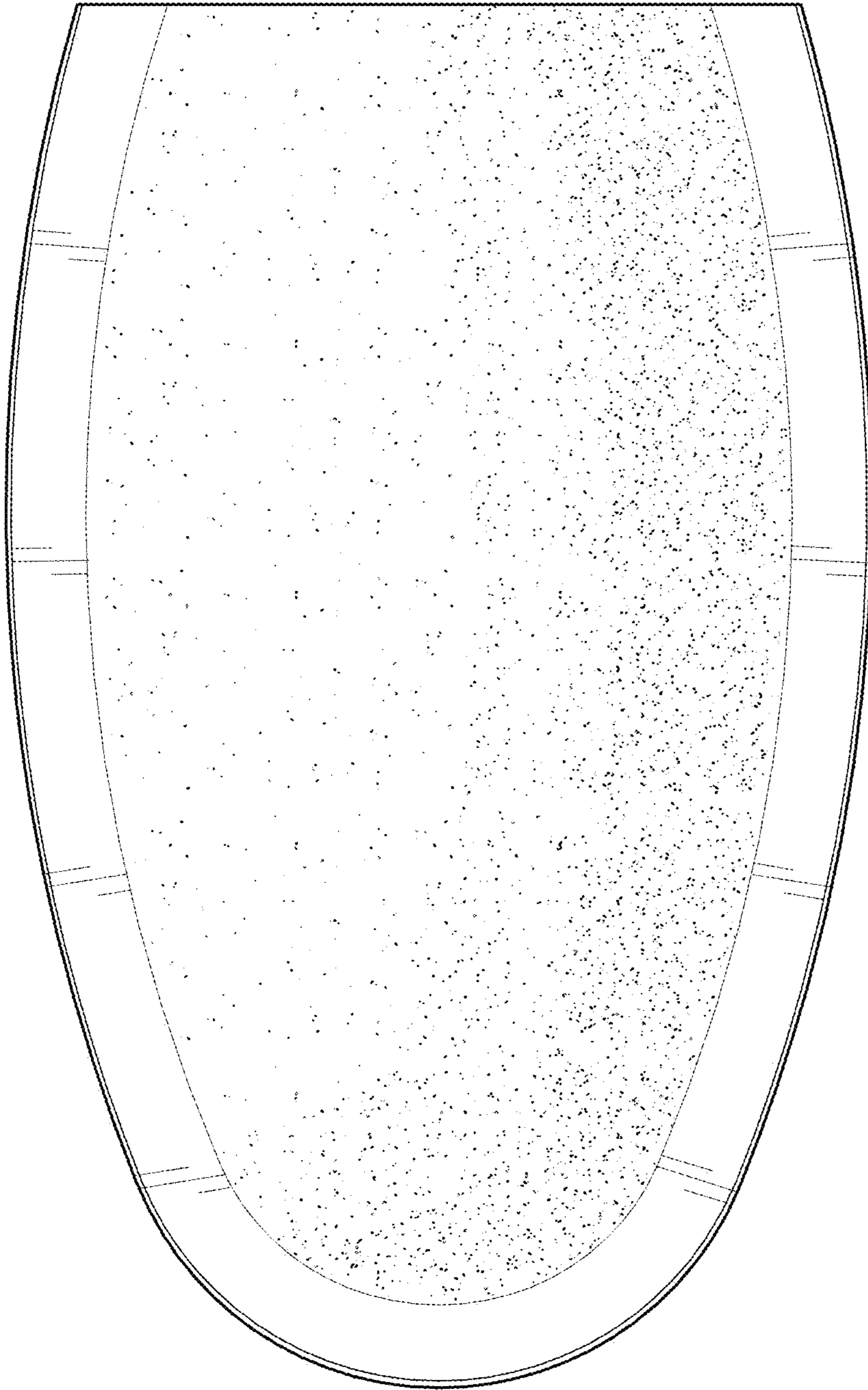

FIG. 6