



US00D942818S

(12) **United States Design Patent**
Ciarrocchi

(10) **Patent No.:** **US D942,818 S**

(45) **Date of Patent:** **** Feb. 8, 2022**

(54) **COLLAPSIBLE CORNER COLANDER**

(71) Applicant: **CALI INTERNATIONAL, LLC**,
Holland, PA (US)

(72) Inventor: **Robert David Ciarrocchi**, Holland, PA
(US)

(73) Assignee: **Cali International, LLC**, Holland, PA
(US)

(**) Term: **15 Years**

(21) Appl. No.: **29/722,021**

(22) Filed: **Jan. 24, 2020**

(51) **LOC (13) Cl.** **31-00**

(52) **U.S. Cl.**
USPC **D7/667**

(58) **Field of Classification Search**
USPC D7/368, 587, 667, 669, 678, 670, 679,
D7/683
CPC A47J 43/24; B01D 35/28
See application file for complete search history.

(56) **References Cited**

U.S. PATENT DOCUMENTS

- 2,030,708 A * 2/1936 Mitchell A47J 47/20
4/290
- D289,452 S * 4/1987 Fuller D30/132
- D385,756 S * 11/1997 Licari D7/667
- D396,610 S * 8/1998 Licari D7/667
- D432,368 S * 10/2000 Kaposi D7/667
- D558,001 S * 12/2007 Stewart D7/667
- D664,012 S * 7/2012 De Leo D7/672
- D665,233 S * 8/2012 Shamoon D7/667
- D718,580 S * 12/2014 Lee D7/667
- D732,354 S * 6/2015 Hinds D7/667
- D736,042 S * 8/2015 Serrahima et al.
- D778,691 S * 2/2017 Powell A47J 43/24
D7/667
- D835,477 S * 12/2018 Pawluskiewicz D7/667

- D840,197 S * 2/2019 Lee D7/667
- D857,460 S * 8/2019 Spater D7/587
- D866,238 S * 11/2019 Tran D7/354
- D907,444 S * 1/2021 Huang D7/587
- D910,260 S * 2/2021 Xie D32/55
- 2006/0096929 A1 * 5/2006 Repp A47J 19/00
210/740
- 2014/0102956 A1 * 4/2014 Powell A47J 43/24
210/85

OTHER PUBLICATIONS

QVC website, 3.5-qt collapsible corner colander, Earliest comment date Jan. 11, 2020, [site visited Sep. 3, 2021], Available on the Internet URL <https://www.qvc.com/35-qt-Collapsible-Corner-Colander-product.K48861.html??TZ=EST> (Year: 2020).*

YouTube.com—QVCtv, 3.5-qt Collapsible Corner Colander on QVC, Published Jan. 5, 2020, [site visited Sep. 3, 2021], Available on the Internet URL <https://www.youtube.com/watch?v=5eBFSilgC34> (Year: 2020).*

* cited by examiner

Primary Examiner — S. Bryan Reinholdt, Jr.

(74) *Attorney, Agent, or Firm* — Volpe Koenig

(57) **CLAIM**

I claim the ornamental design for a collapsible corner colander, as shown and described.

DESCRIPTION

FIG. 1 is a top perspective view of a collapsible corner colander in accordance with the design;
FIG. 2 is a bottom perspective view thereof;
FIG. 3 is a top view thereof;
FIG. 4 is a bottom view thereof;
FIG. 5 is a back side view thereof; and,
FIG. 6 is a side view thereof.

1 Claim, 6 Drawing Sheets

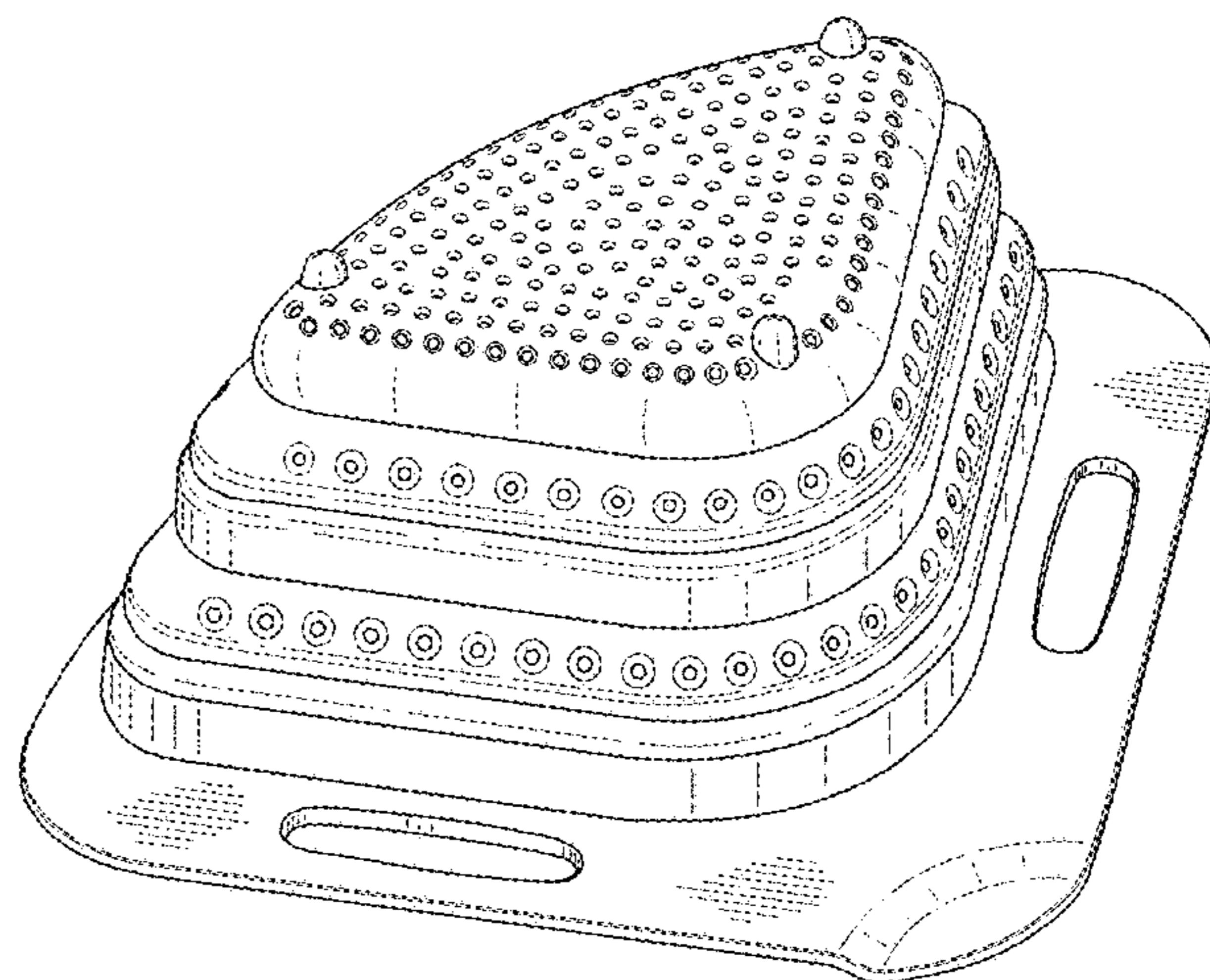
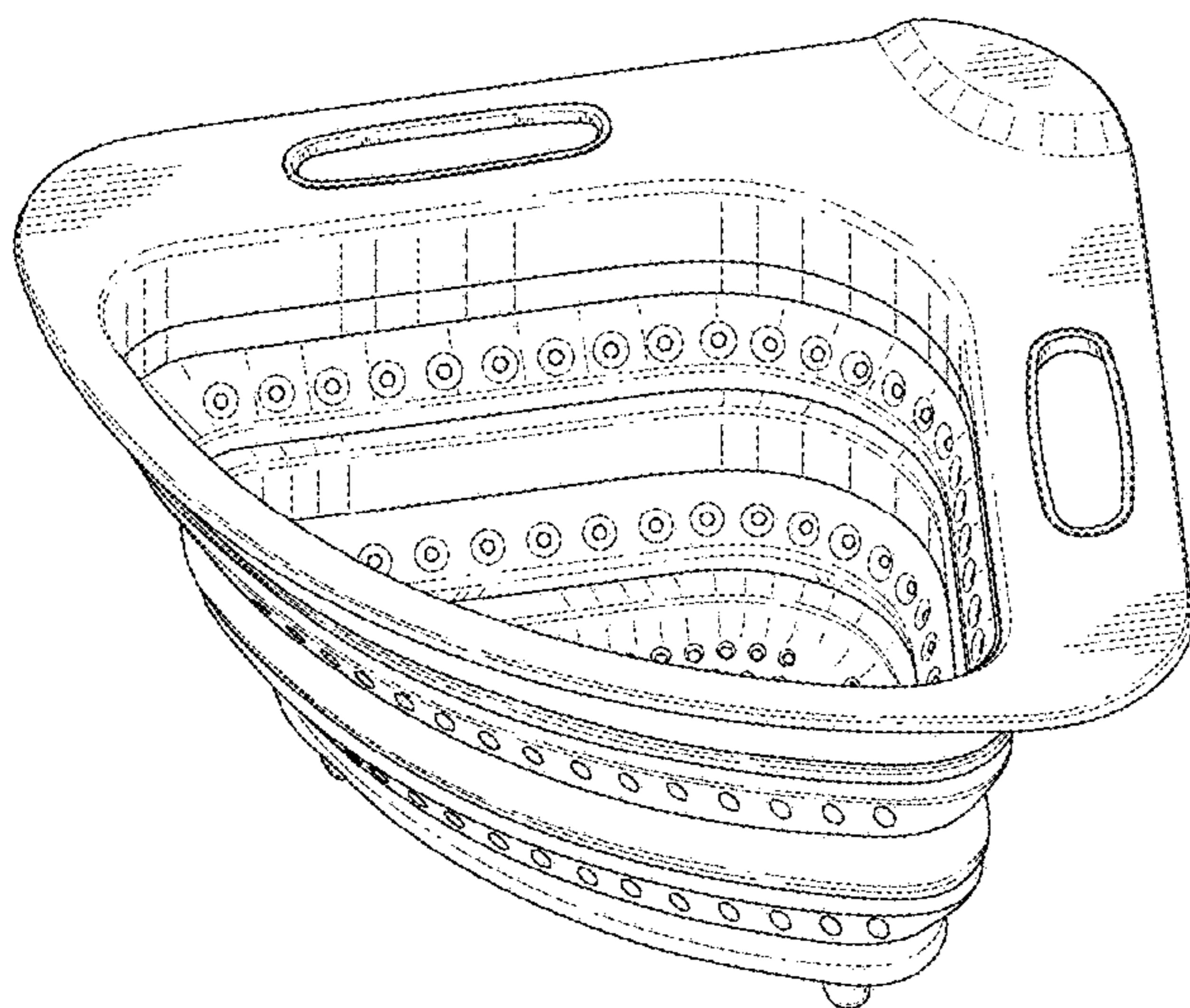

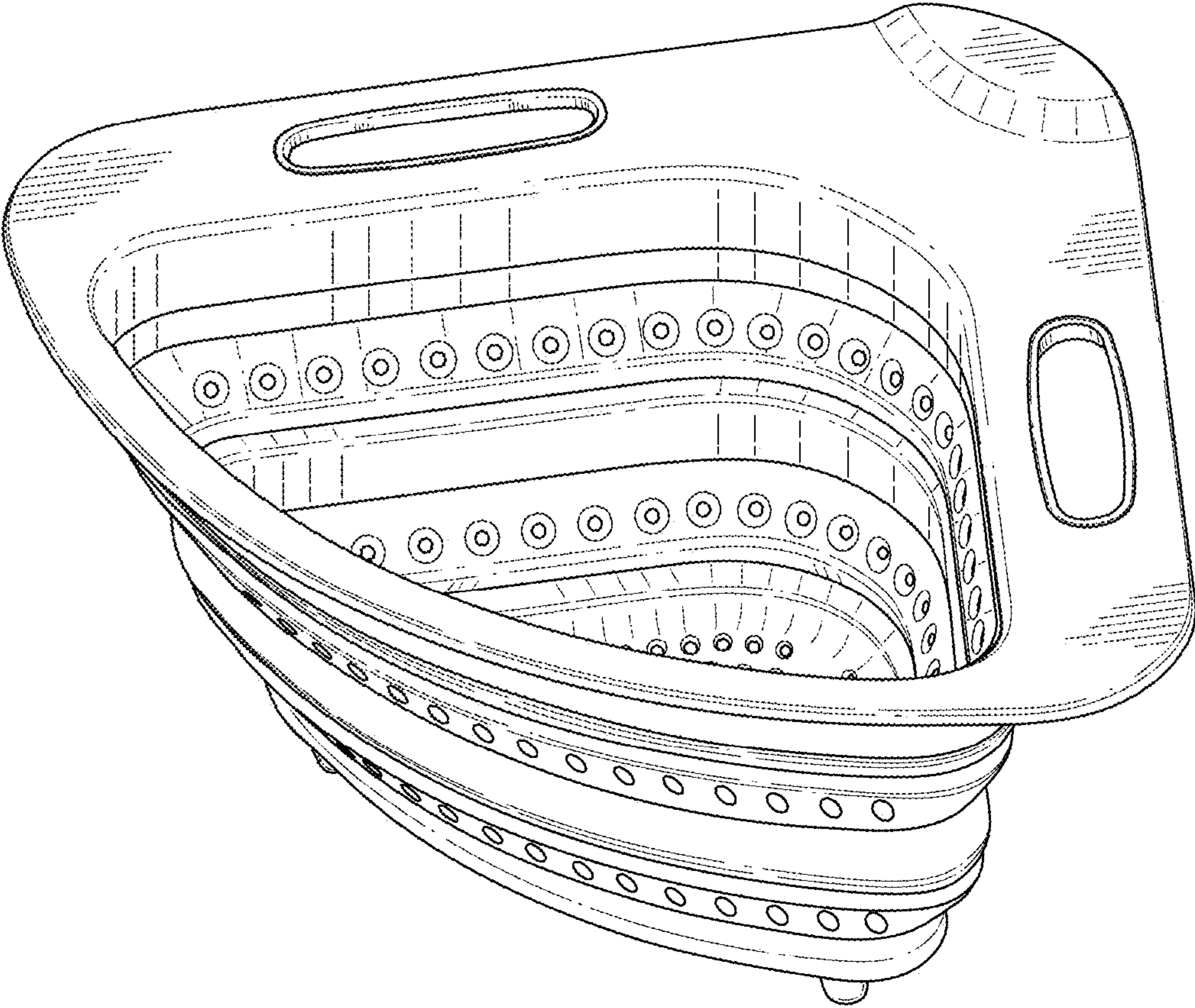

FIG. 1

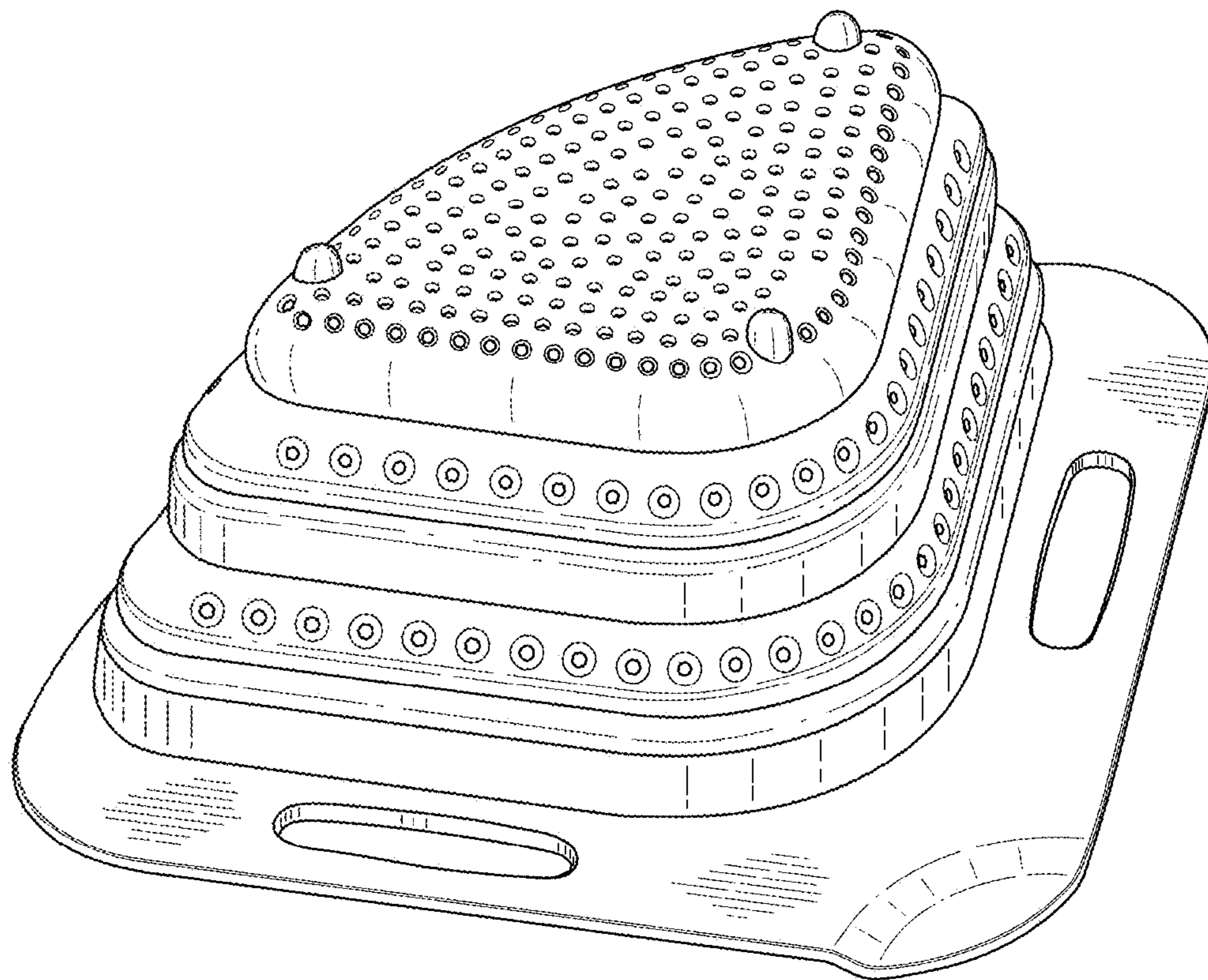

FIG. 2

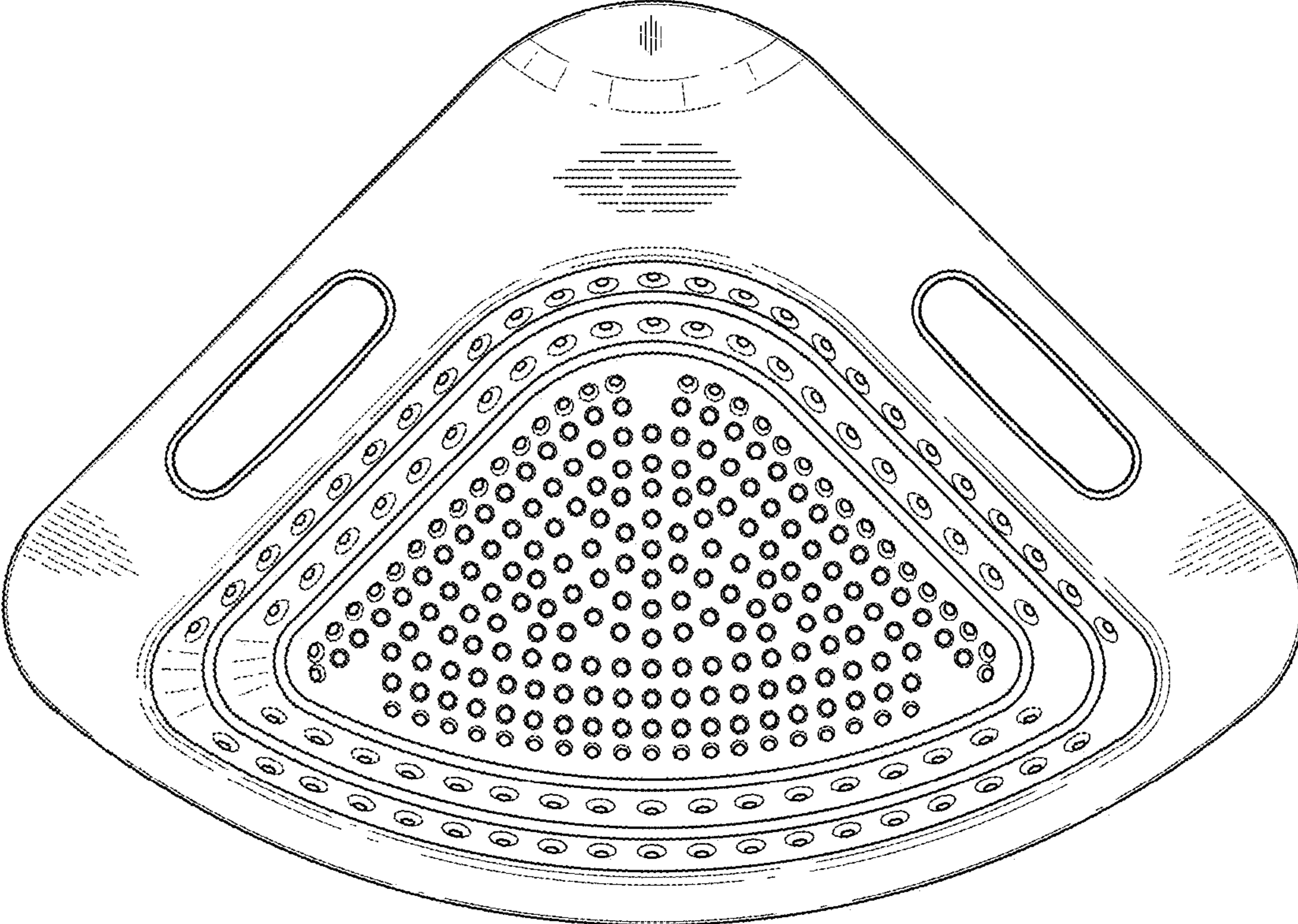

FIG. 3

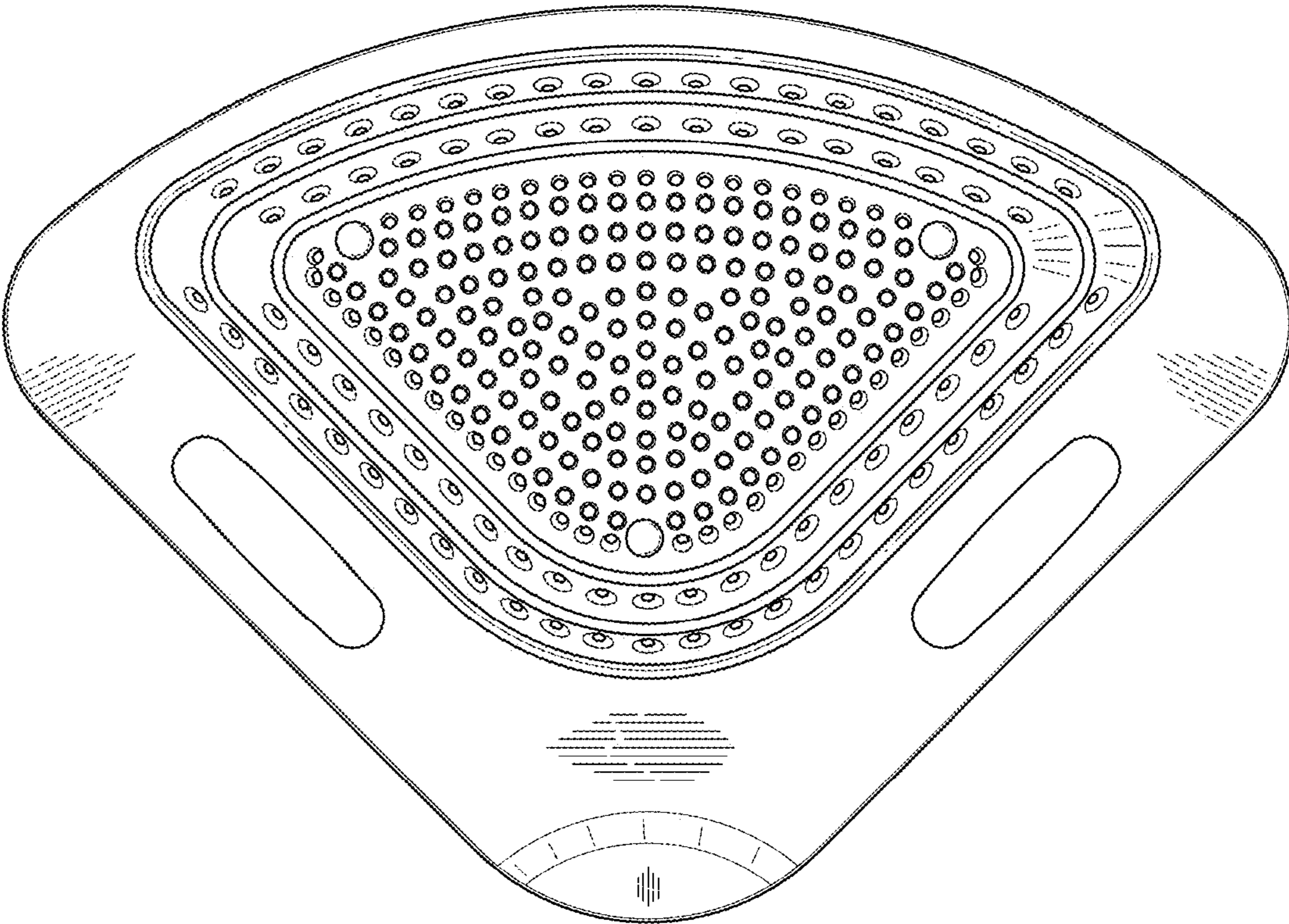

FIG. 4

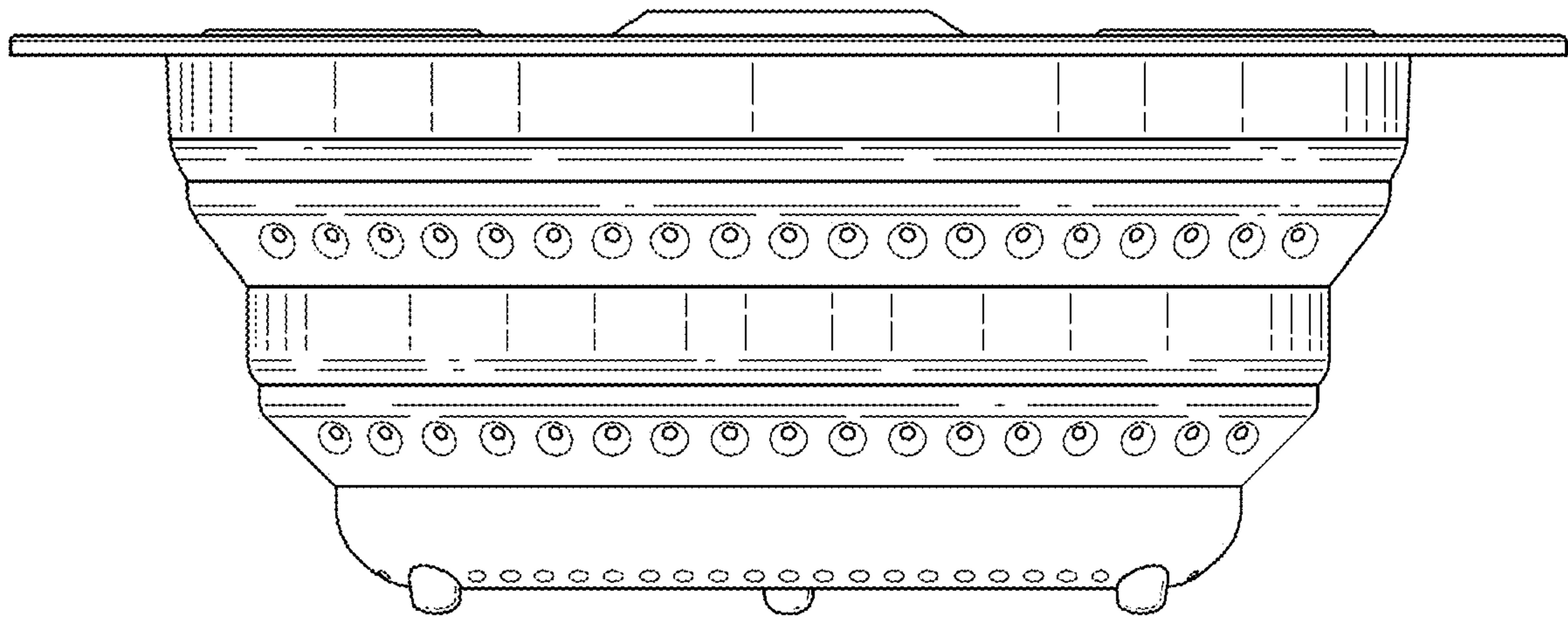

FIG. 5

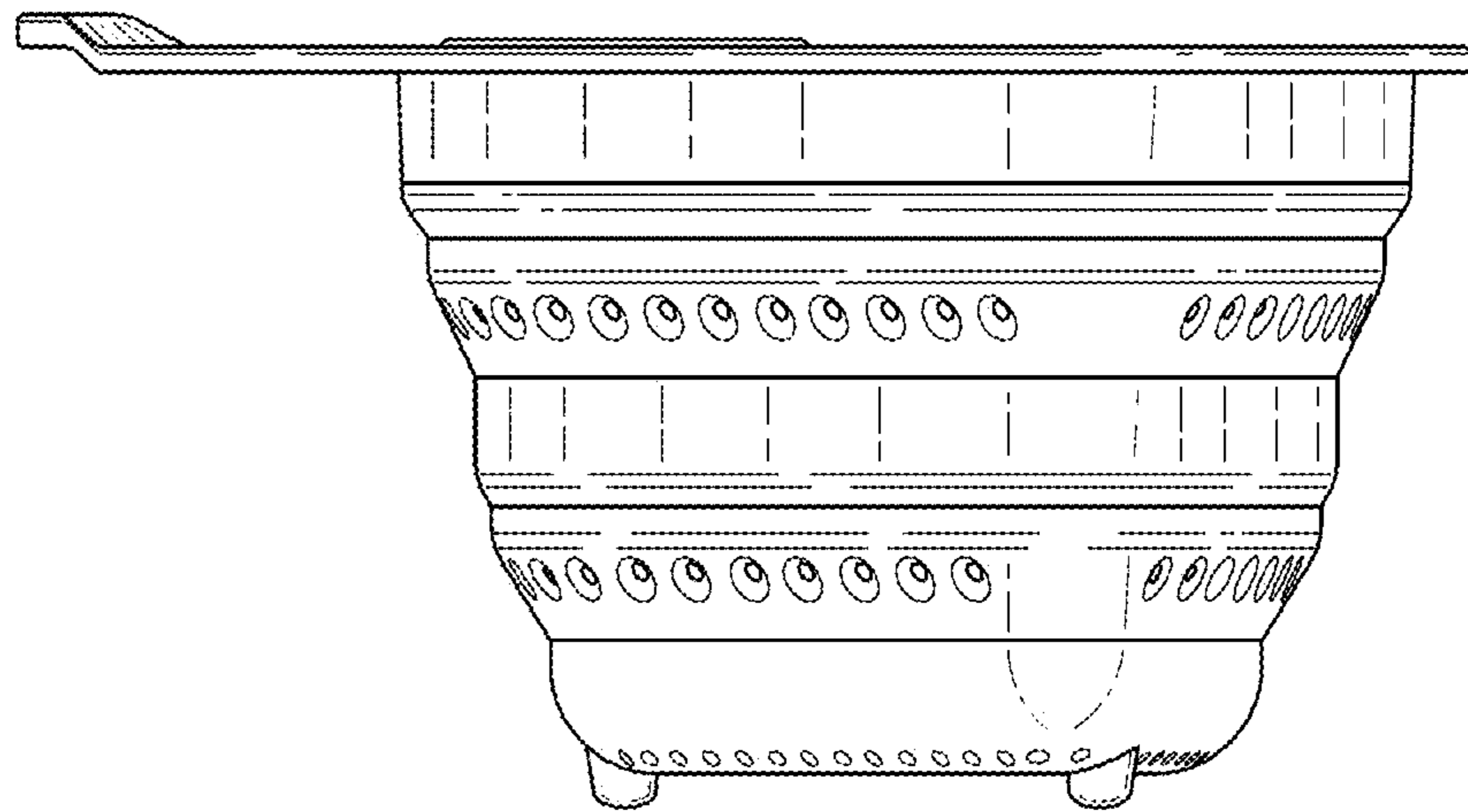

FIG. 6