



US00D942783S

(12) **United States Design Patent**
Li

(10) **Patent No.:** **US D942,783 S**

(45) **Date of Patent:** **** *Feb. 8, 2022**

(54) **SHELF**

(71) Applicant: **39F USA INC**, Rancho Cucamonga, CA (US)

(72) Inventor: **Yuehai Li**, Rancho Cucamonga, CA (US)

(*) Notice: This patent is subject to a terminal disclaimer.

(**) Term: **15 Years**

(21) Appl. No.: **29/727,080**

(22) Filed: **Mar. 9, 2020**

(51) **LOC (13) Cl.** **06-06**

(52) **U.S. Cl.**
USPC **D6/675.1**

(58) **Field of Classification Search**
USPC D6/672, 675, 675.1, 675.2, 683, 682, D6/682.1
CPC A47F 5/00; A47F 5/0018; A47F 5/0043; B25H 3/00; A47B 55/00; A47B 96/02
See application file for complete search history.

(56) **References Cited**

U.S. PATENT DOCUMENTS

D301,413 S * 6/1989 Rosen D6/661
D301,812 S * 6/1989 Handler D6/681.1

D303,879 S * 10/1989 Williams D6/673
D330,472 S * 10/1992 Wells D6/675.1
D491,385 S * 6/2004 Sexton D6/675.1
D505,574 S * 5/2005 Sexton D6/675.1
D518,665 S * 4/2006 Palmquist D6/675.1
D613,967 S * 4/2010 Sexton D6/675.1
D614,421 S * 4/2010 Sexton D6/675.1
D614,888 S * 5/2010 Sexton D6/675.1
D748,416 S * 2/2016 Meissner D6/675.1
D824,703 S * 8/2018 Yamamoto D6/675.1
D866,229 S * 11/2019 Wu D6/675.1
D891,831 S * 8/2020 Davis D6/675.1
D907,407 S * 1/2021 Davis D6/654.1
D907,413 S * 1/2021 Bogdan D6/675.1

* cited by examiner

Primary Examiner — Kelley A Donnelly
(74) *Attorney, Agent, or Firm* — Feng Qian

(57) **CLAIM**

The ornamental design for a shelf, as shown and described.

DESCRIPTION

FIG. 1 is a front perspective view of a shelf showing my new design;
FIG. 2 is a front elevation view thereof;
FIG. 3 is a rear elevation view thereof;
FIG. 4 is a left-side elevation view thereof;
FIG. 5 is a right-side elevation view thereof;
FIG. 6 is a top plan view thereof; and,
FIG. 7 is a rear plan view thereof.

1 Claim, 7 Drawing Sheets

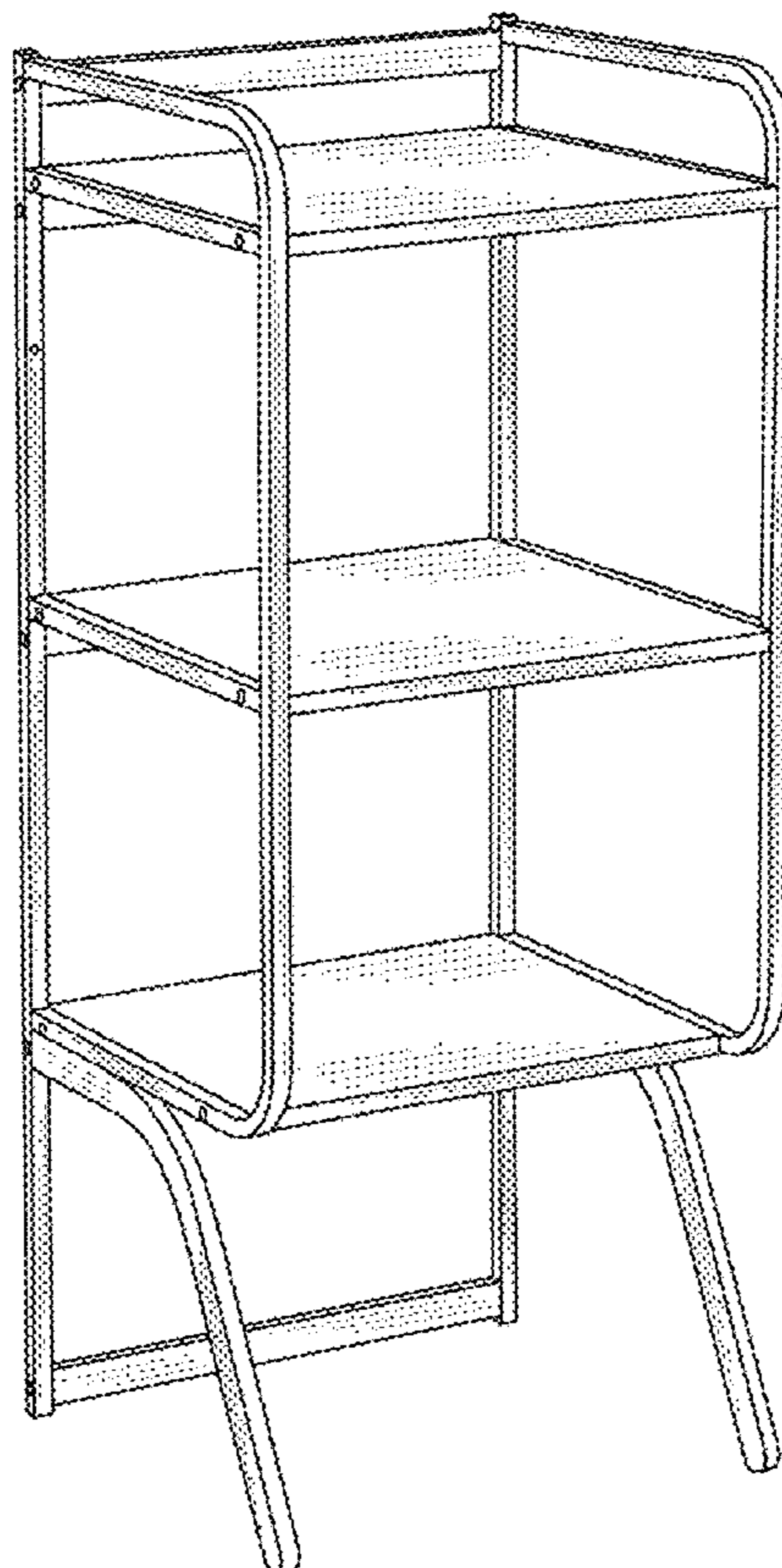

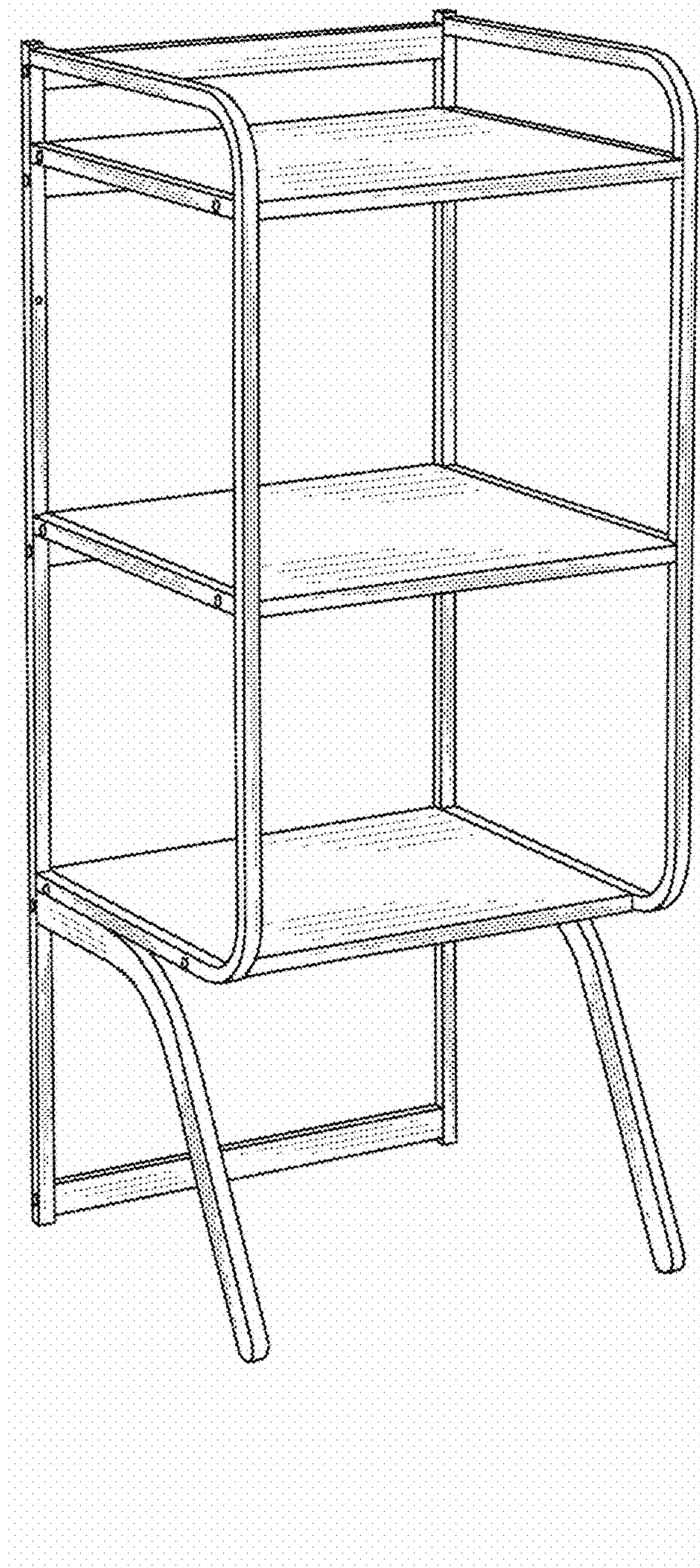

Fig.1

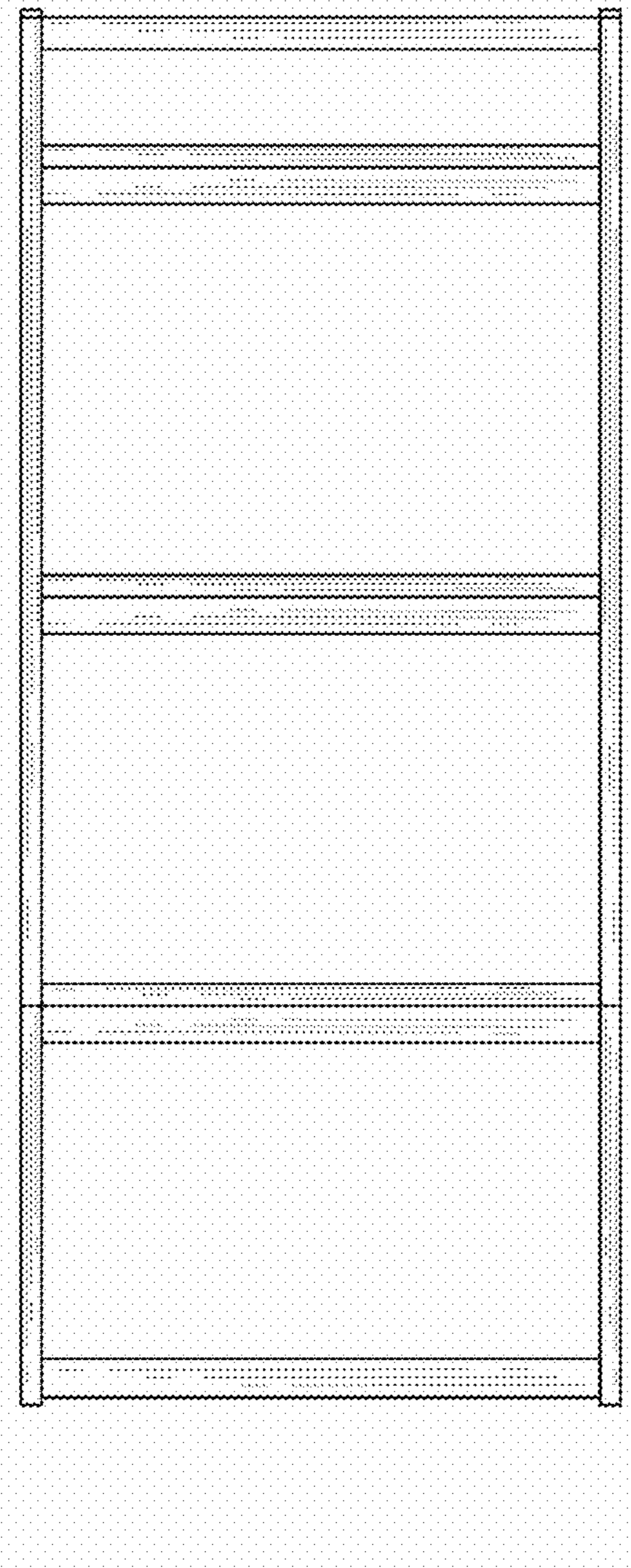

Fig.2

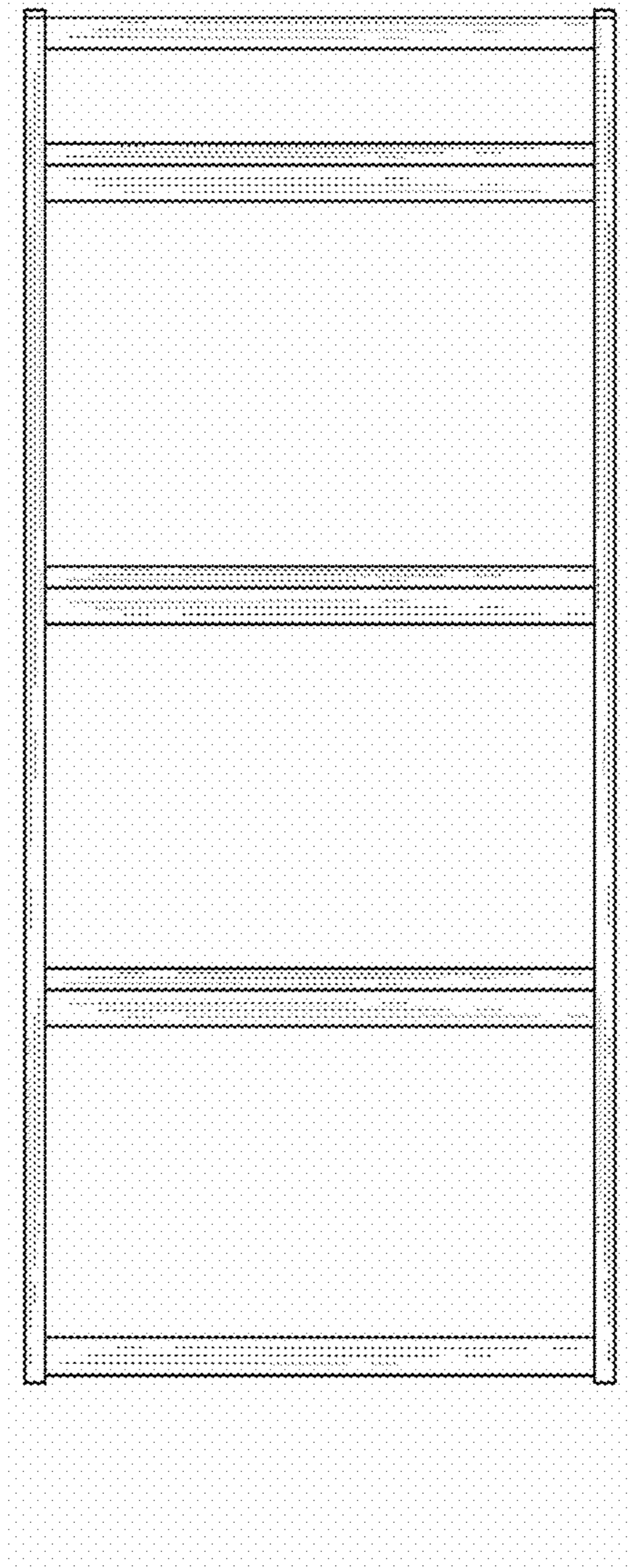

Fig.3

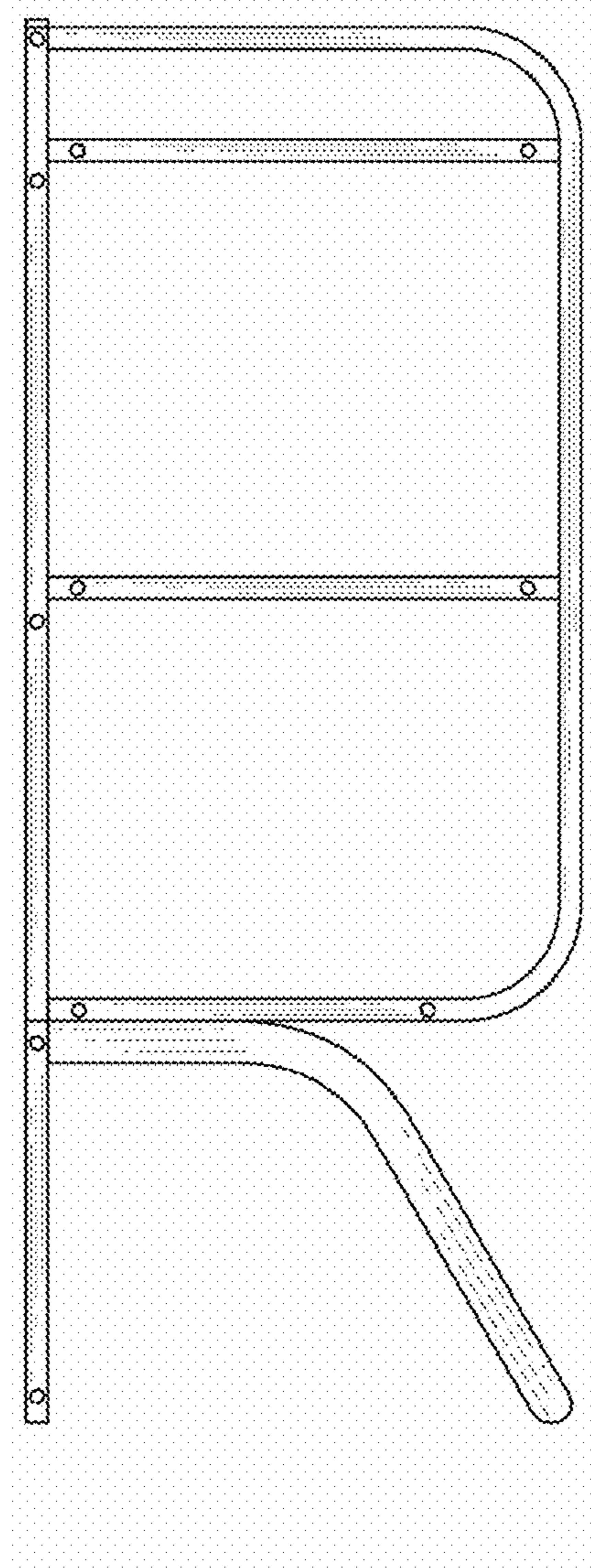

Fig.4

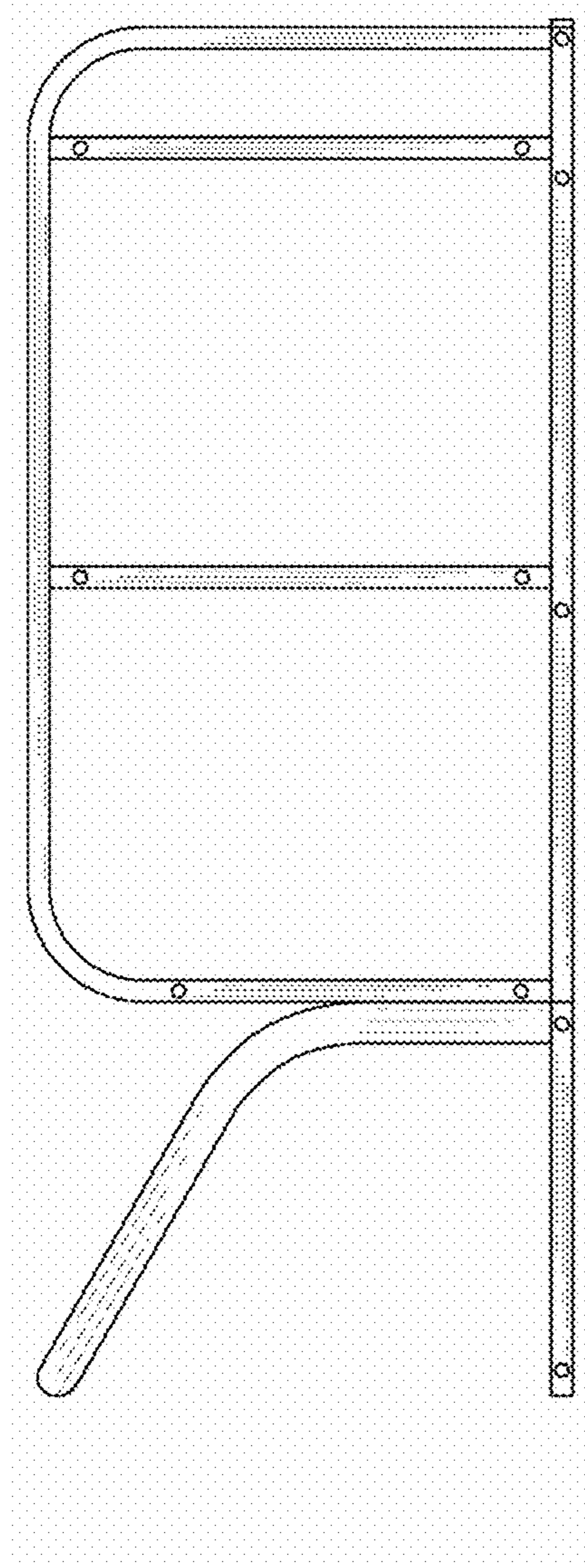

Fig.5

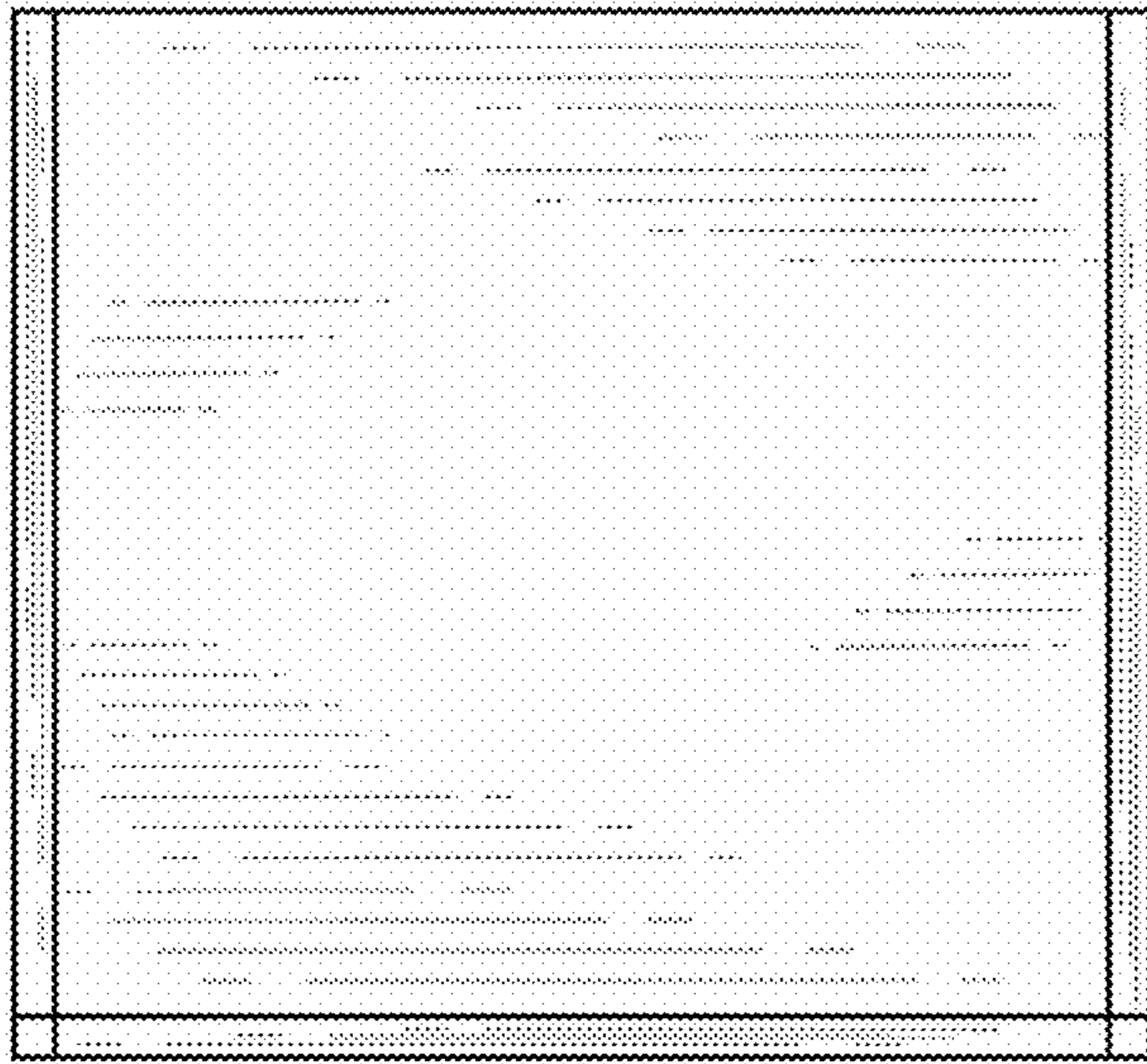

Fig.6

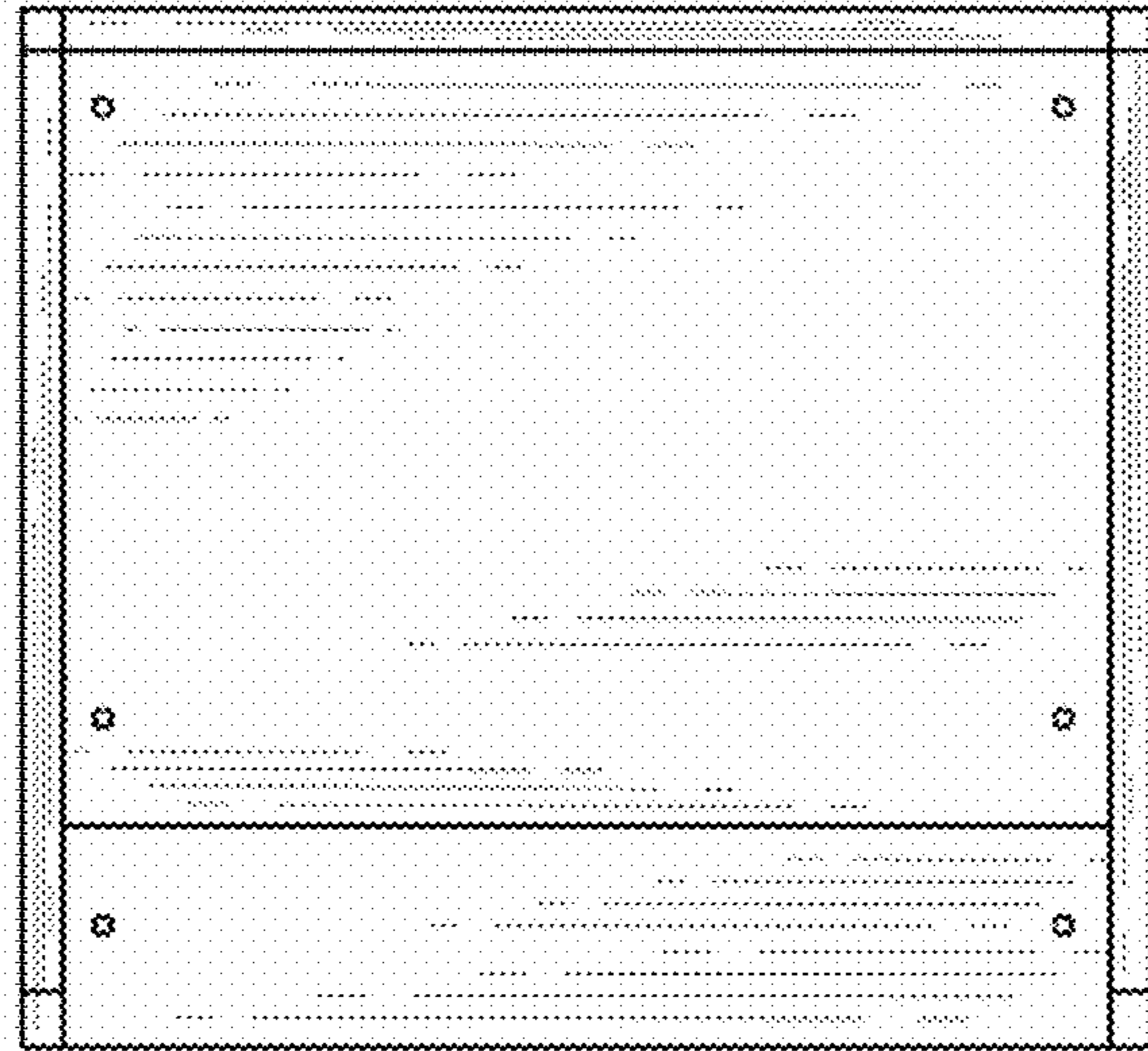

Fig.7