



US00D942738S

(12) **United States Design Patent** (10) **Patent No.:** **US D942,738 S**
Seo (45) **Date of Patent:** **** Feb. 8, 2022**

(54) **EDIBLE ICE**
(71) Applicant: **INTYCO Co., Ltd.**, Uiwang-si (KR)
(72) Inventor: **Sang Jun Seo**, Seongnam-si (KR)
(73) Assignee: **INTYCO Co., Ltd.**, Uiwang-si (KR)
(**) Term: **15 Years**
(21) Appl. No.: **29/755,660**
(22) Filed: **Oct. 22, 2020**
(30) **Foreign Application Priority Data**

Jul. 10, 2020 (KR) 30-2020-0031643
(51) **LOC (13) Cl.** **01-01**
(52) **U.S. Cl.**
USPC **D1/130; D1/199**
(58) **Field of Classification Search**
USPC D1/100–130, 199; 426/104, 108, 138,
426/391, 549, 808, 94, 143, 559, 560;
D11/12, 24, 40, 43, 79, 86, 95;
D24/101–104; 446/118, 128; D21/318,
D21/335, 484, 499, 503, 707, 713;
D9/707, 756; D30/160
CPC A23G 3/50; A23G 3/54; A23J 3/26; A23L
1/0067
See application file for complete search history.

(56) **References Cited**
U.S. PATENT DOCUMENTS
D277,727 S * 2/1985 Klaric D8/382
D340,489 S * 10/1993 Evangelista D21/713
D467,287 S * 12/2002 Manville D21/498
D469,824 S * 2/2003 Manville D21/498
6,669,526 B2 * 12/2003 Manville A63H 33/101
446/100
D511,029 S * 10/2005 Willinger D21/713
D651,671 S * 1/2012 Ross D21/680

D710,568 S * 8/2014 Fox D1/199
D717,521 S * 11/2014 Slusarczyk D1/130
D736,483 S * 8/2015 Crane D30/160
D747,423 S * 1/2016 Gustafson D21/662
D793,499 S * 8/2017 Ormsbee D21/707
D802,157 S * 11/2017 Kasuto D24/224
D802,178 S * 11/2017 Calvin D26/2
D817,562 S * 5/2018 Markham D30/160
D822,295 S * 7/2018 Woods D30/160
D823,951 S * 7/2018 Marton D21/662
D831,750 S * 10/2018 Fontaine D21/398
D834,300 S * 11/2018 Sapara, Jr. D3/201
D854,258 S * 7/2019 Woods D30/160
D910,248 S * 2/2021 Luk D30/160
D917,800 S * 4/2021 Yi D30/160
2020/0352367 A1 * 11/2020 Kennedy B65D 85/808

* cited by examiner

Primary Examiner — Katie Jane Stofko
(74) *Attorney, Agent, or Firm* — Revolution IP, PLLC

(57) **CLAIM**

The ornamental design for an edible ice, as shown and described.

DESCRIPTION

FIG. 1 is a perspective view of an edible ice showing the claimed design;
FIG. 2 is a front view thereof;
FIG. 3 is a rear view thereof;
FIG. 4 is a left side view thereof;
FIG. 5 is a right side view thereof;
FIG. 6 is a top view thereof; and
FIG. 7 is a bottom view thereof; and
FIG. 8 is a perspective view thereof, shown in an environment of use; and,
FIG. 9 is a perspective view thereof, show in another environment of use.
The broken lines shown in FIGS. 8 and 9 illustrate environment that forms no part of the claimed design.

1 Claim, 9 Drawing Sheets

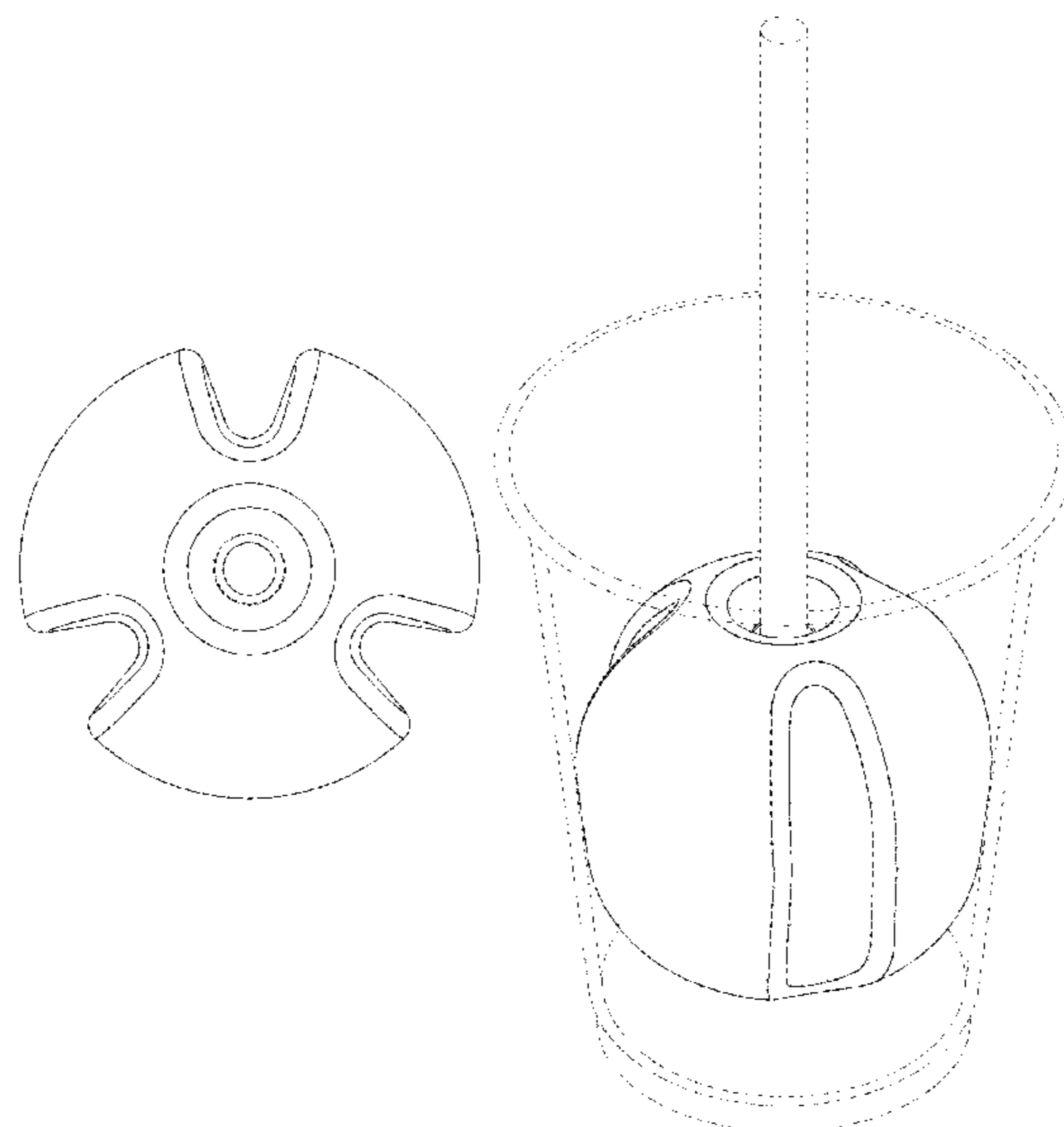

FIG. 1

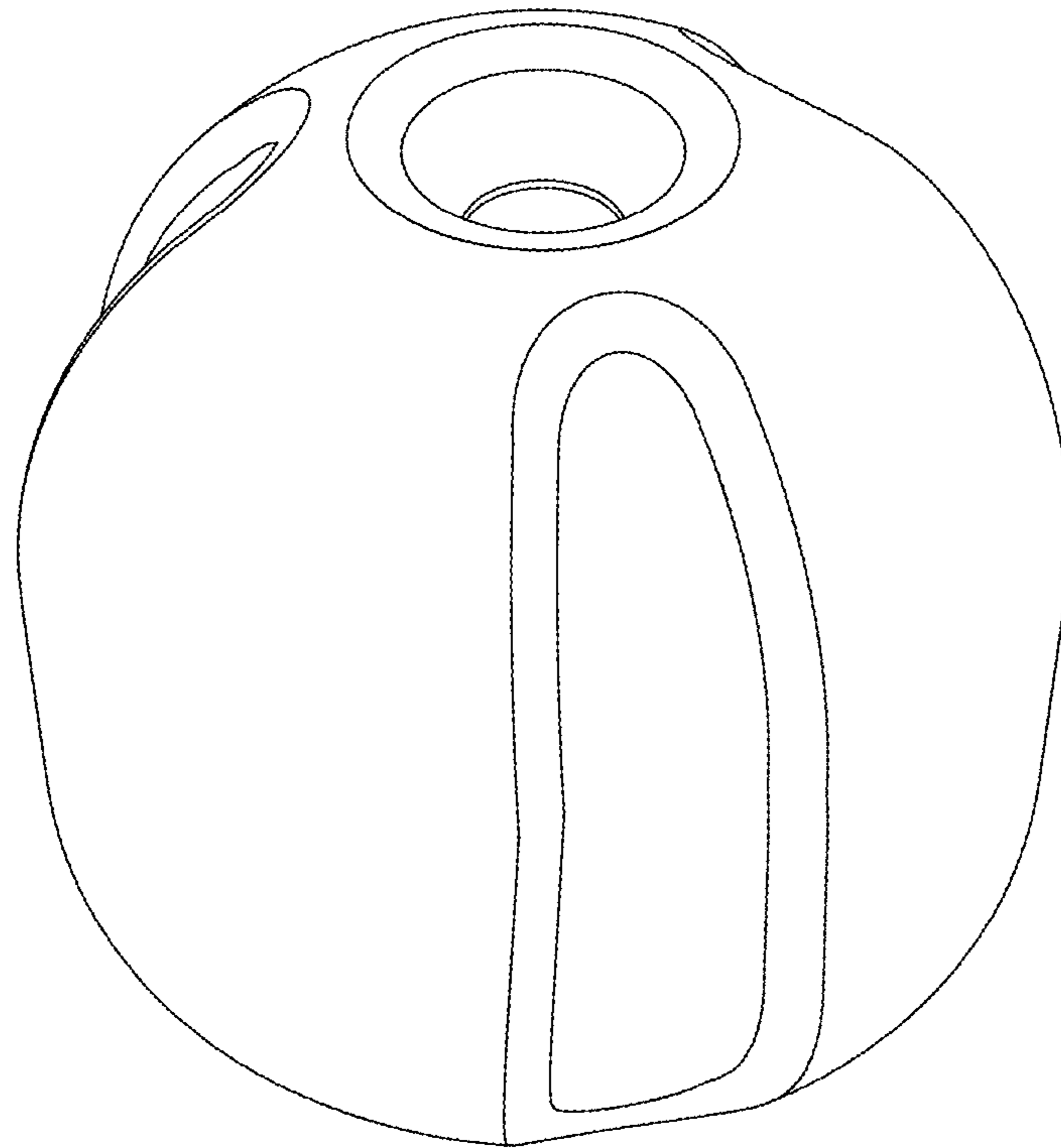

FIG. 2

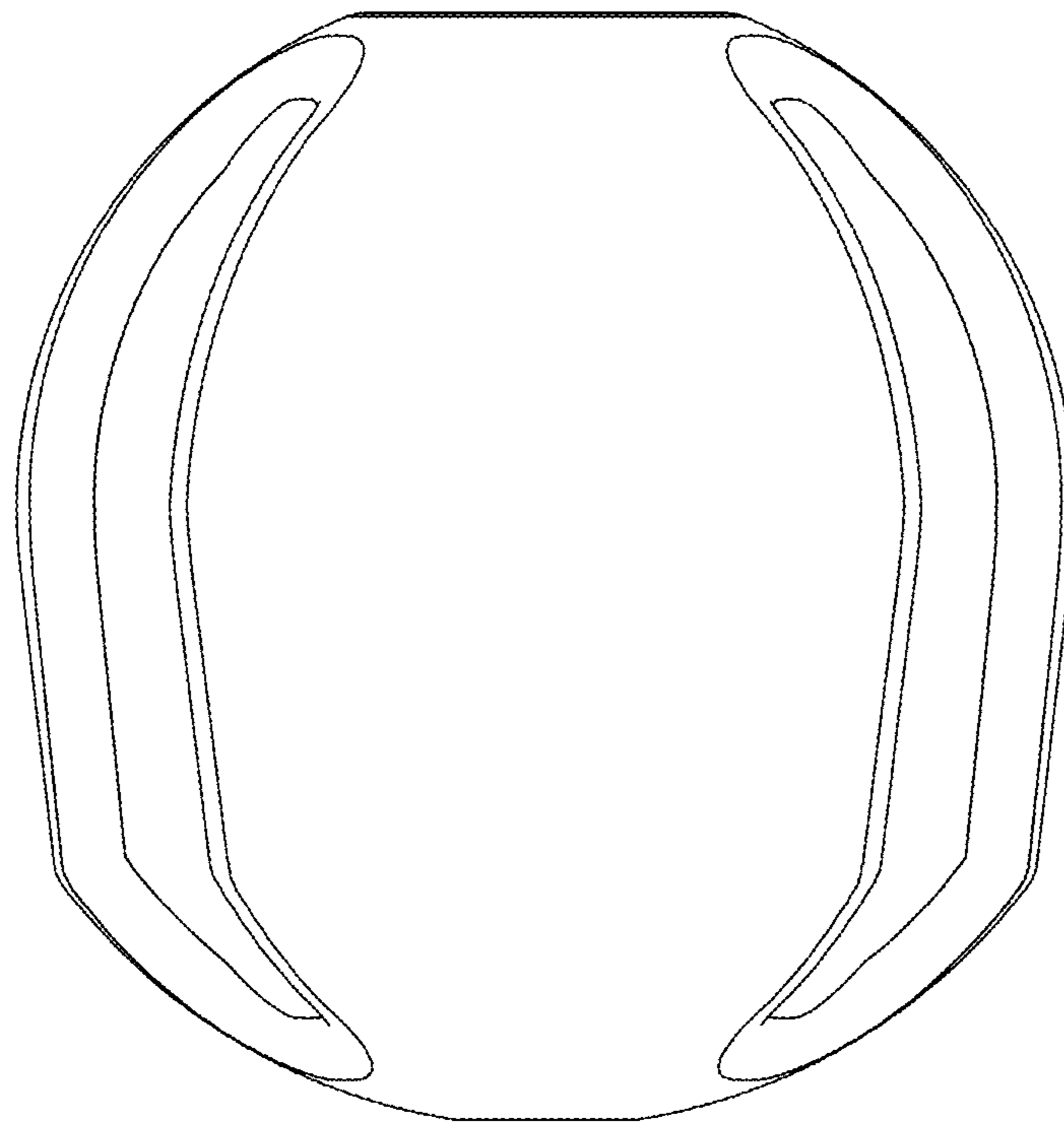

FIG. 3

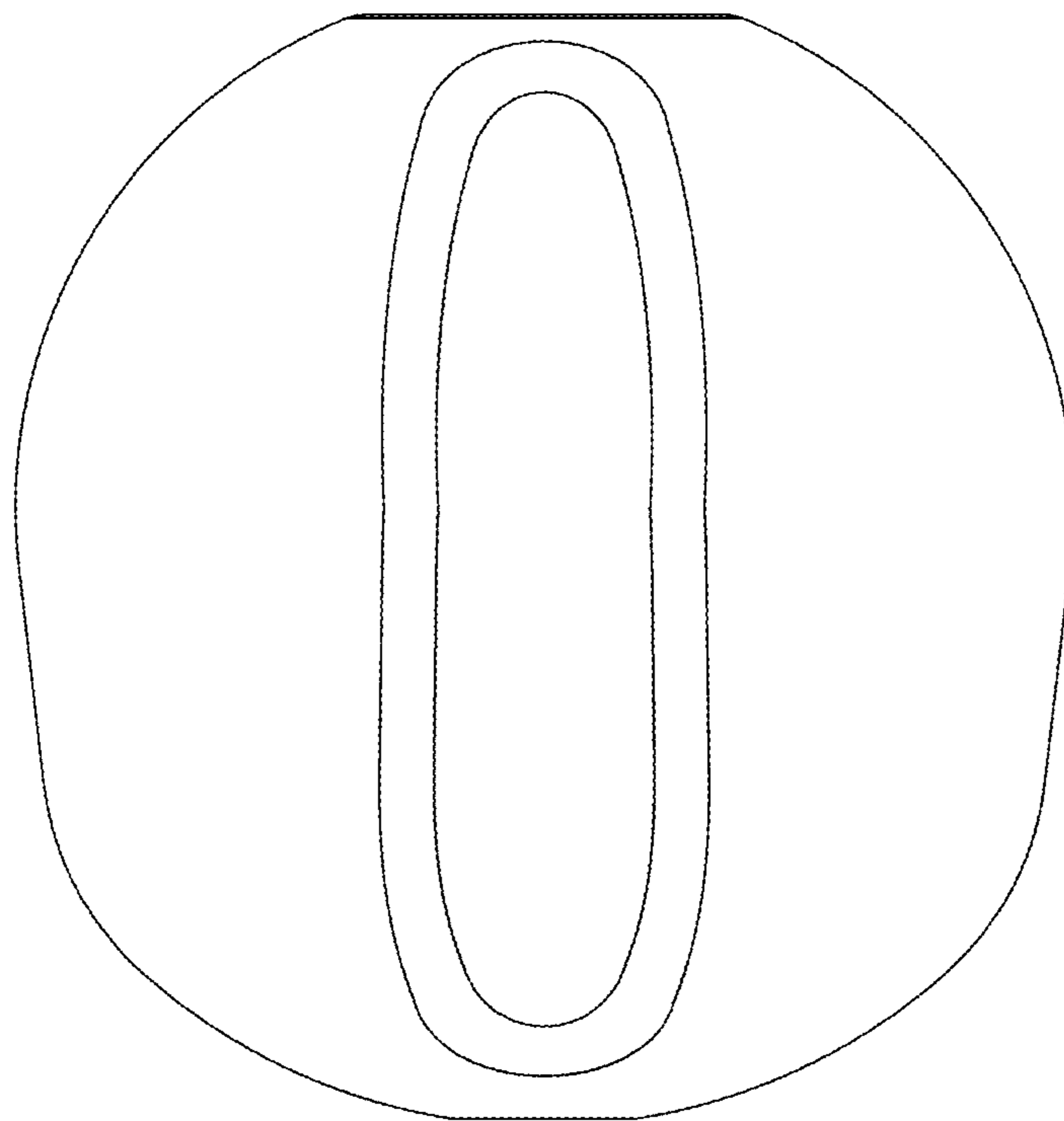

FIG. 4

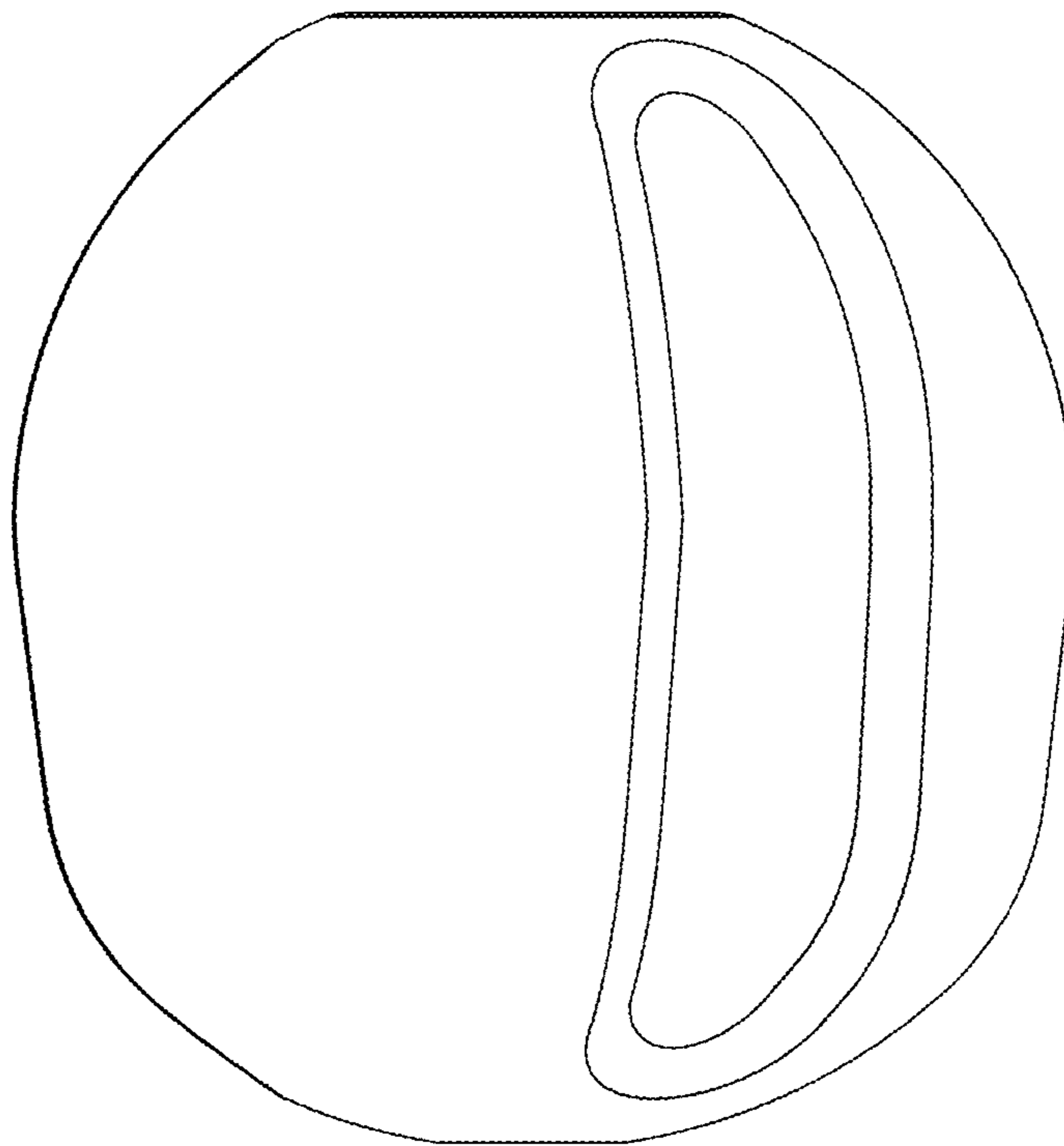

FIG. 5

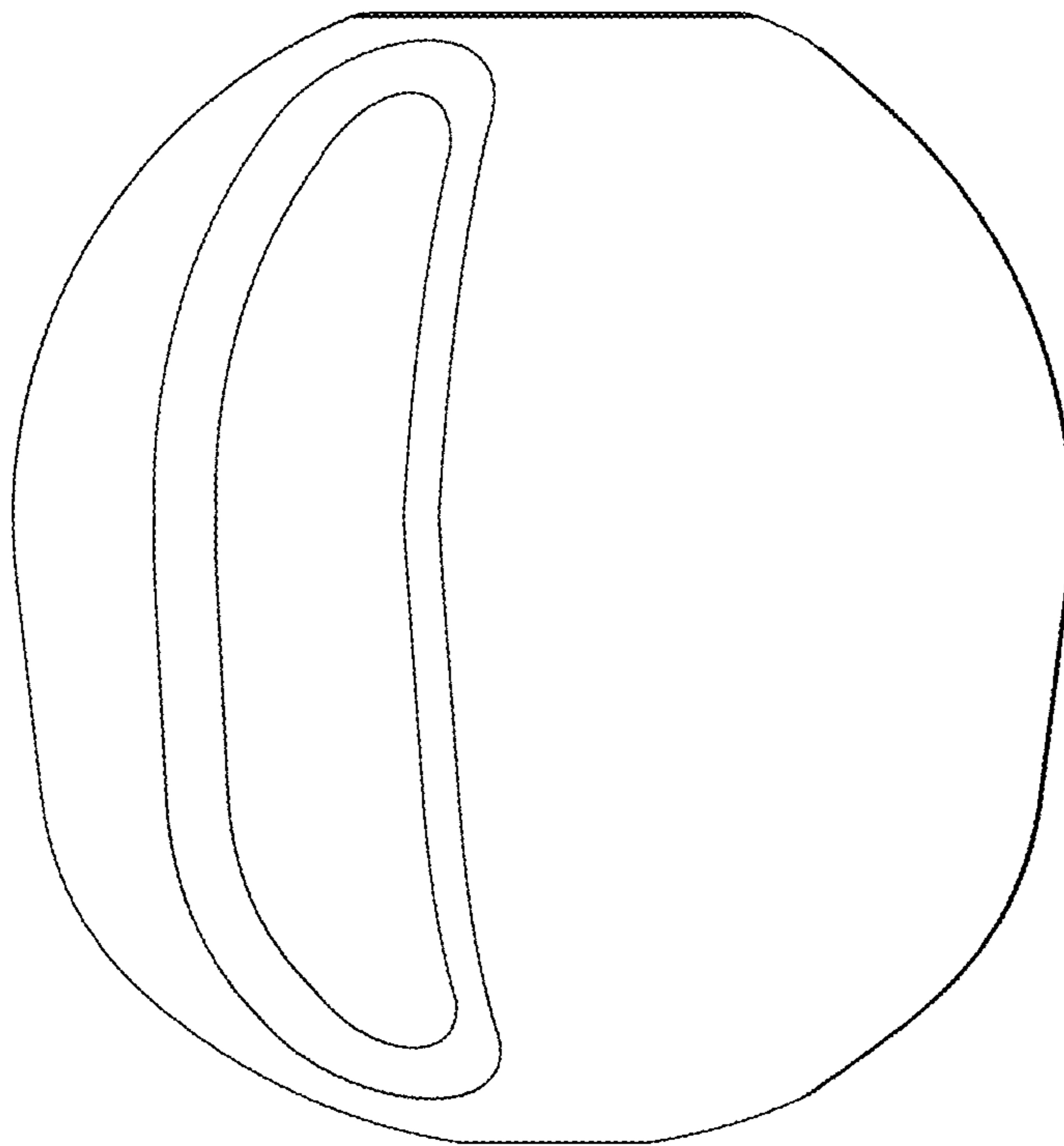

FIG. 6

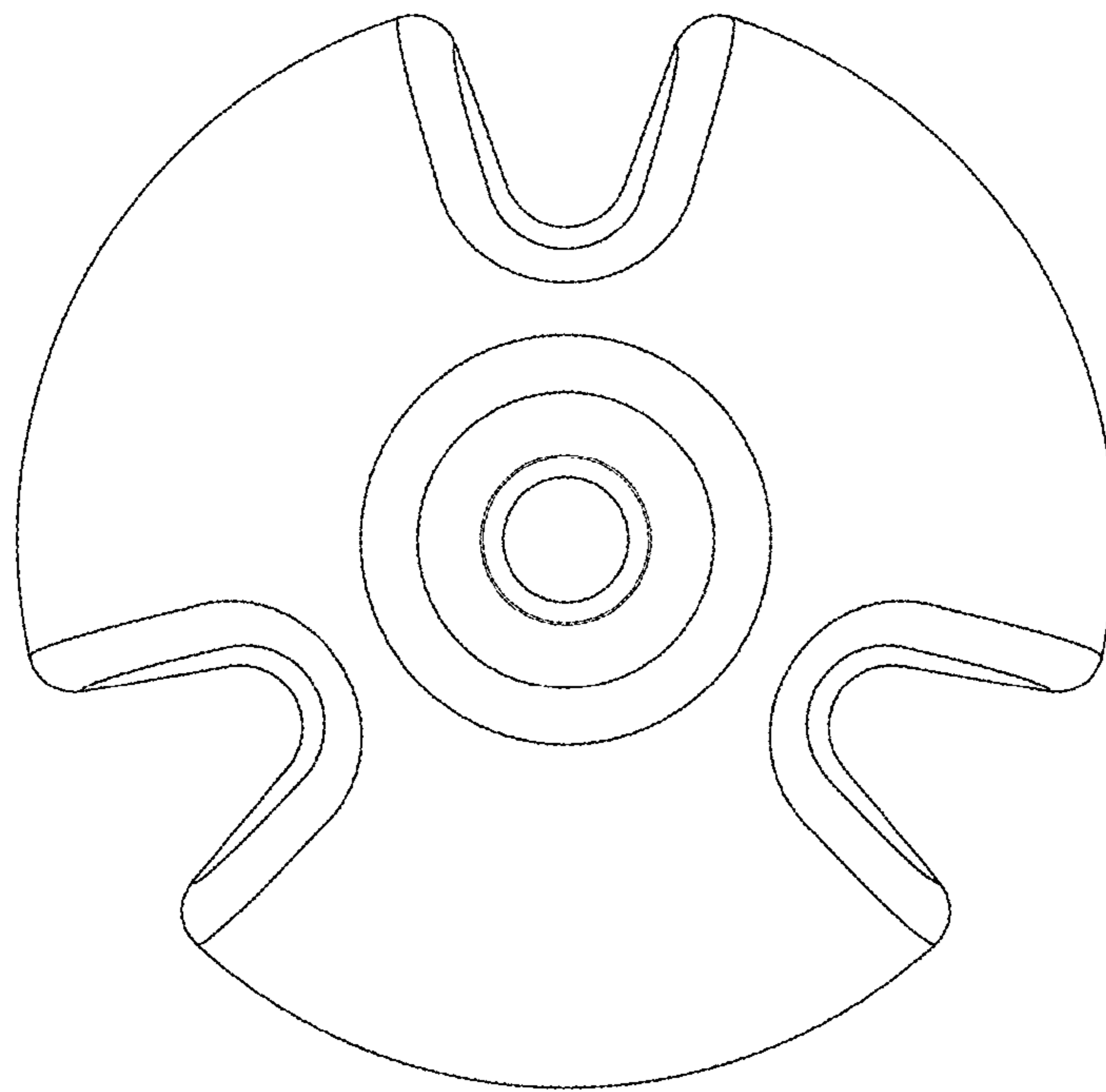

FIG. 7

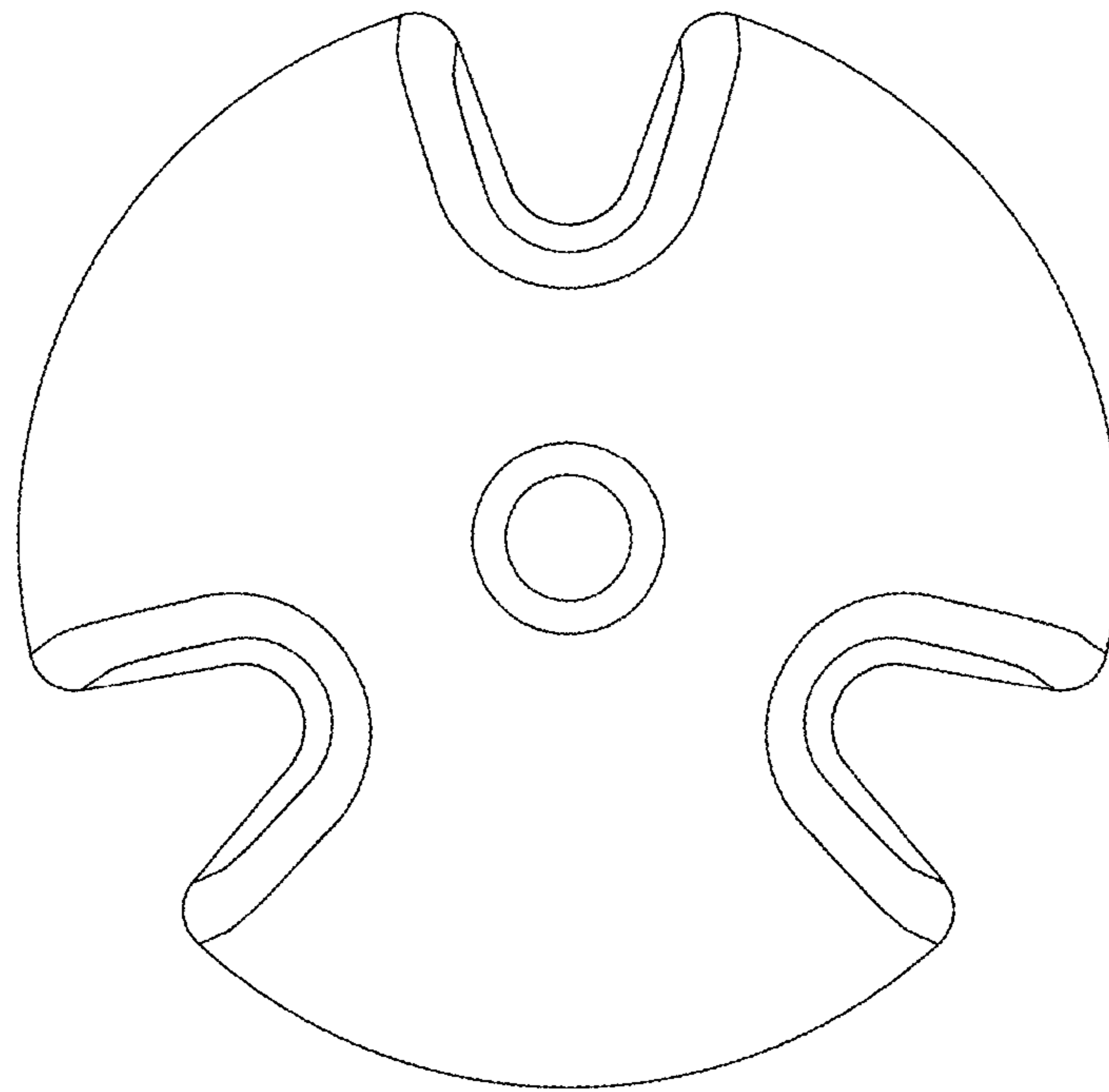

FIG. 8

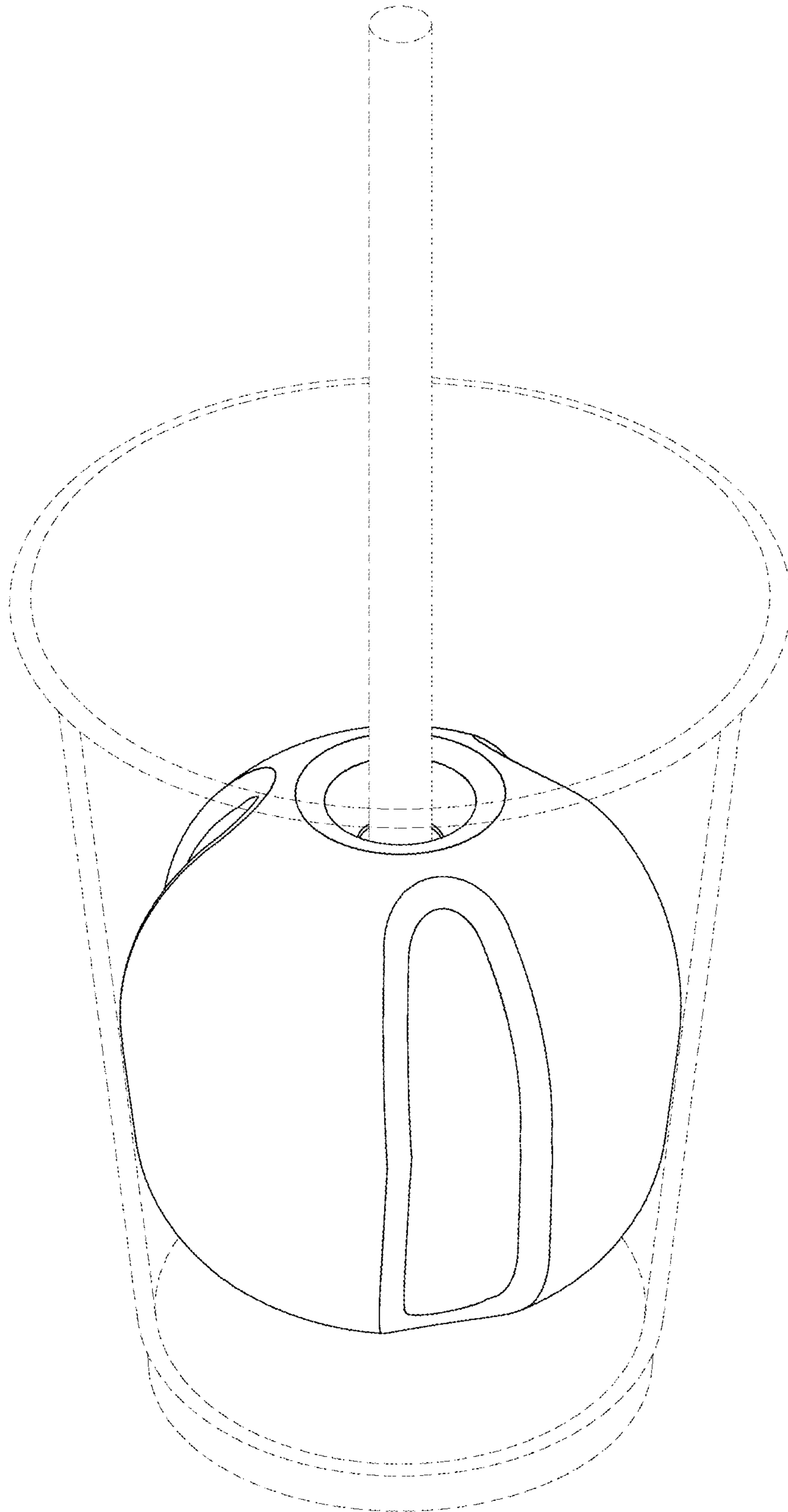

FIG. 9

