



US00D942595S

(12) **United States Design Patent** (10) **Patent No.:** **US D942,595 S**  
**Schilling et al.** (45) **Date of Patent:** **\*\* \*Feb. 1, 2022**

(54) **HOSE ASSEMBLY WITH REINFORCED FIRE SLEEVE**

**DESCRIPTION**

- (71) Applicant: **Eaton Corporation**, Cleveland, OH (US)
- (72) Inventors: **Patrick Alan Schilling**, Jackson, MI (US); **Justin Troy Straley**, Chelsea, MI (US); **John Paul Brittain**, Jackson, MI (US)
- (73) Assignee: **Eaton Intelligent Power Limited**, Dublin (IE)
- (\*) Notice: This patent is subject to a terminal disclaimer.
- (\*\*) Term: **15 Years**
- (21) Appl. No.: **29/562,322**
- (22) Filed: **Apr. 25, 2016**
- (51) **LOC (13) Cl.** ..... **23-01**
- (52) **U.S. Cl.**  
USPC ..... **D23/266**
- (58) **Field of Classification Search**  
USPC ..... D23/259, 262–263, 266, 223, 249;  
D24/129; D13/155; 138/103, 105,  
(Continued)

(56) **References Cited**

**U.S. PATENT DOCUMENTS**

- D21,561 S \* 5/1892 Wilkinson ..... D23/266
  - D46,944 S \* 2/1915 Coughlin ..... D23/266
- (Continued)

*Primary Examiner* — Amy C Wierenga  
(74) *Attorney, Agent, or Firm* — Benesch, Friedlander, Coplan & Aronoff LLP

(57) **CLAIM**

What is claimed is the ornamental design for a hose assembly with reinforced fire sleeve, as shown and described.

FIG. 1 is a perspective view of a first embodiment of a hose assembly with reinforced fire sleeve;  
 FIG. 2 is a front elevation view of the hose assembly with reinforced fire sleeve of FIG. 1;  
 FIG. 3 is a rear elevation view of the hose assembly with reinforced fire sleeve of FIG. 1;  
 FIG. 4 is a left side elevation view of the hose assembly with reinforced fire sleeve of FIG. 1;  
 FIG. 5 is a right side elevation view of the hose assembly with reinforced fire sleeve of FIG. 1;  
 FIG. 6 is a top plan view of the hose assembly with reinforced fire sleeve of FIG. 1;  
 FIG. 7 is a bottom plan view of the hose assembly with reinforced fire sleeve of FIG. 1;  
 FIG. 8 is a perspective view of a second embodiment of a hose assembly with reinforced fire sleeve;  
 FIG. 9 is a front elevation view of the hose assembly with reinforced fire sleeve of FIG. 8;  
 FIG. 10 is a rear elevation view of the hose assembly with reinforced fire sleeve of FIG. 8;  
 FIG. 11 is a left side elevation view of the hose assembly with reinforced fire sleeve of FIG. 8;  
 FIG. 12 is a right side elevation view of the hose assembly with reinforced fire sleeve of FIG. 8;  
 FIG. 13 is a top plan view of the hose assembly with reinforced fire sleeve of FIG. 8;  
 FIG. 14 is a bottom plan view of the hose assembly with reinforced fire sleeve of FIG. 8;  
 FIG. 15 is a perspective view of a third embodiment of a hose assembly with reinforced fire sleeve;  
 FIG. 16 is a front elevation view of the hose assembly with reinforced fire sleeve of FIG. 15;  
 FIG. 17 is a rear elevation view of the hose assembly with reinforced fire sleeve of FIG. 15;  
 FIG. 18 is a left side elevation view of the hose assembly with reinforced fire sleeve of FIG. 15;  
 FIG. 19 is a right side elevation view of the hose assembly with reinforced fire sleeve of FIG. 15;  
 FIG. 20 is a top plan view of the hose assembly with reinforced fire sleeve of FIG. 15;

(Continued)

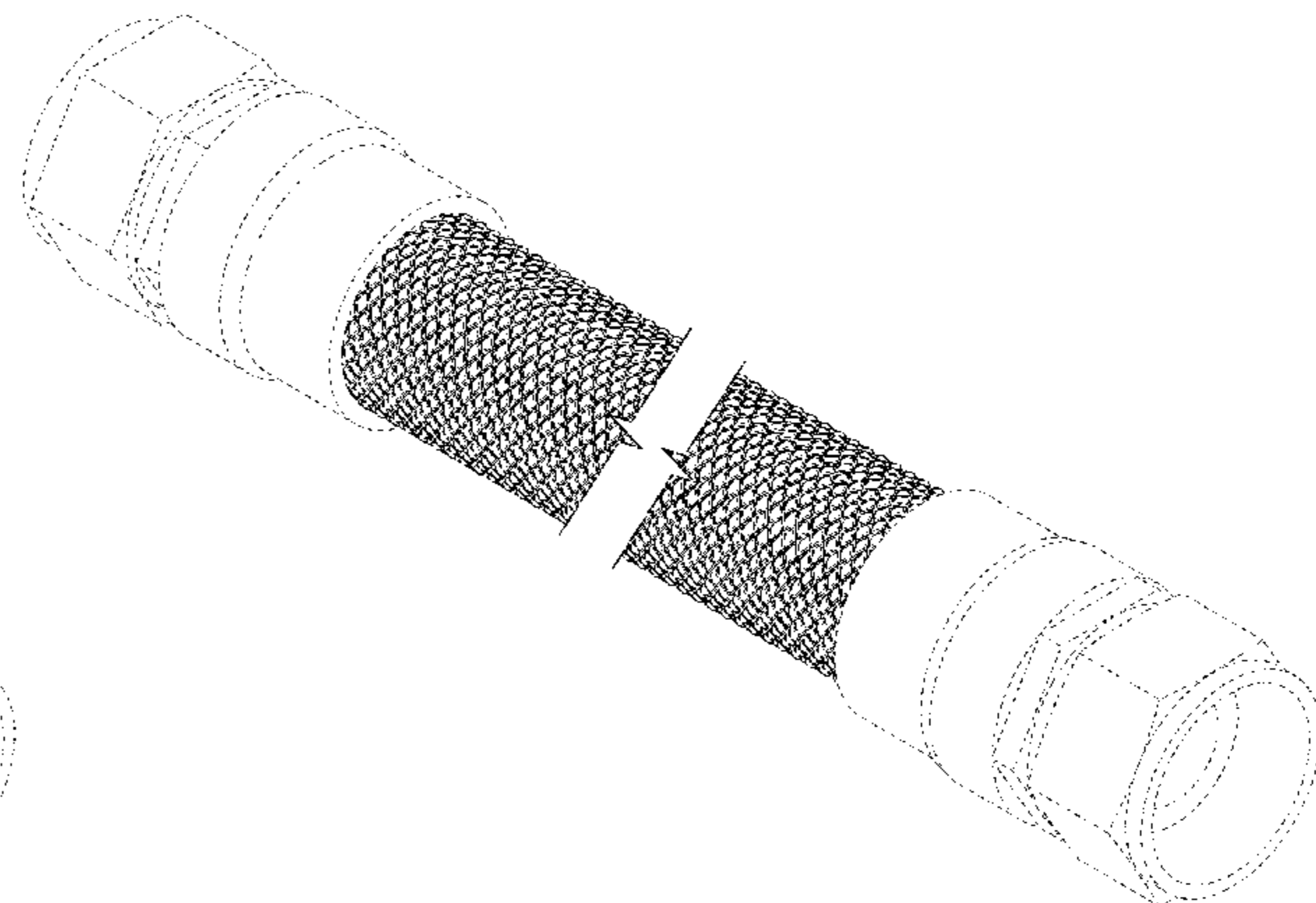
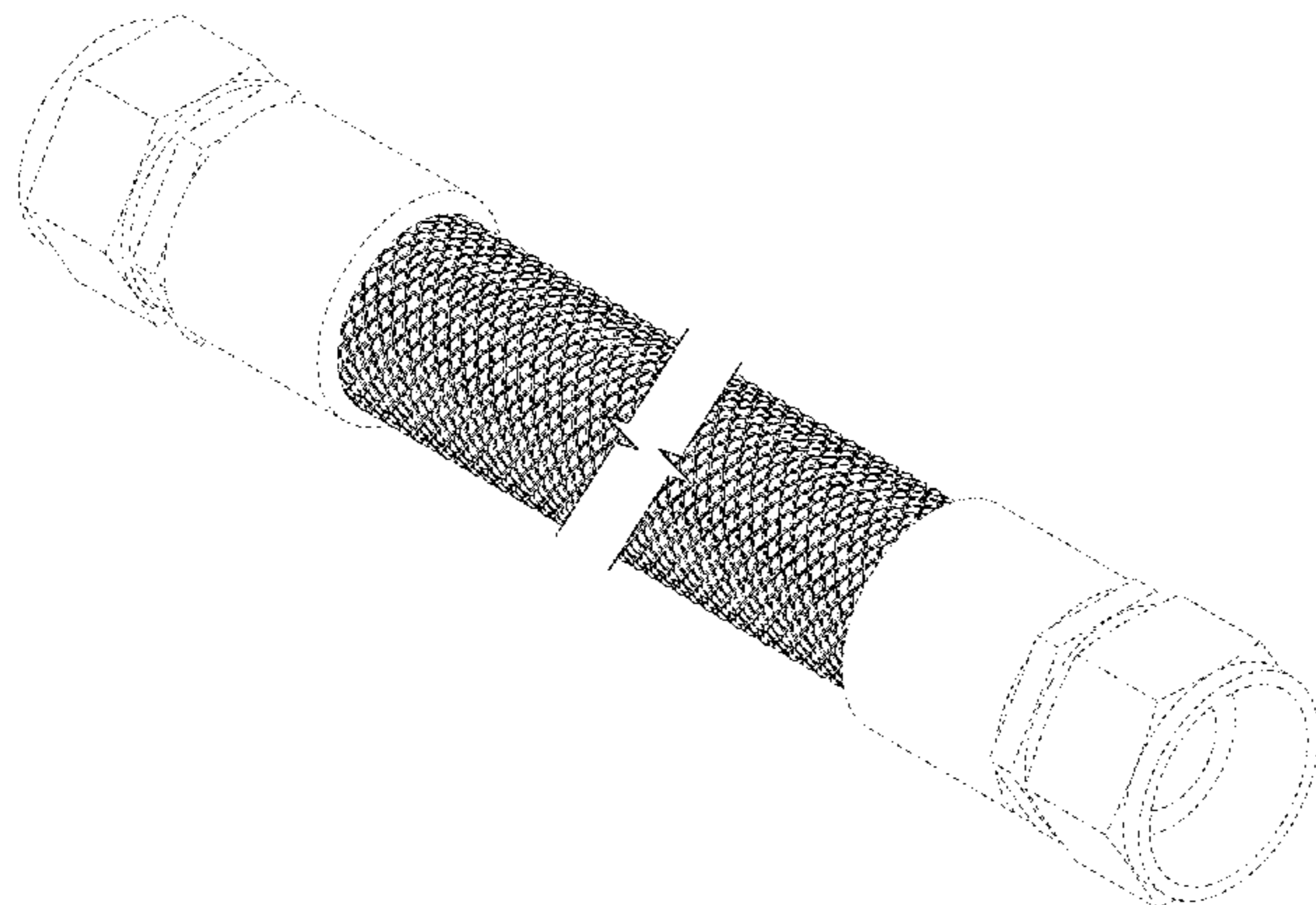

FIG. 21 is a bottom plan view of the hose assembly with reinforced fire sleeve of FIG. 15;  
 FIG. 22 is a perspective view of a fourth embodiment of a hose assembly with reinforced fire sleeve;  
 FIG. 23 is a front elevation view of the hose assembly with reinforced fire sleeve of FIG. 22;  
 FIG. 24 is a rear elevation view of the hose assembly with reinforced fire sleeve of FIG. 22;  
 FIG. 25 is a left side elevation view of the hose assembly with reinforced fire sleeve of FIG. 22;  
 FIG. 26 is a right side elevation view of the hose assembly with reinforced fire sleeve of FIG. 22;  
 FIG. 27 is a top plan view of the hose assembly with reinforced fire sleeve of FIG. 22;  
 FIG. 28 is a bottom plan view of the hose assembly with reinforced fire sleeve of FIG. 22;  
 FIG. 29 is a perspective view of a fifth embodiment of a hose assembly with reinforced fire sleeve;  
 FIG. 30 is a front elevation view of the hose assembly with reinforced fire sleeve of FIG. 29;  
 FIG. 31 is a rear elevation view of the hose assembly with reinforced fire sleeve of FIG. 29;  
 FIG. 32 is a left side elevation view of the hose assembly with reinforced fire sleeve of FIG. 29;  
 FIG. 33 is a right side elevation view of the hose assembly with reinforced fire sleeve of FIG. 29;  
 FIG. 34 is a top plan view of the hose assembly with reinforced fire sleeve of FIG. 29; and,  
 FIG. 35 is a bottom plan view of the hose assembly with reinforced fire sleeve of FIG. 29.  
 The hose assembly with reinforced fire sleeve is shown with a symbolic break in its length. The appearance of any portion of the hose between the break lines forms no part of the claimed design.  
 The broken lines shown in the drawings illustrate portions of the hose assembly with reinforced fire sleeve that form no part of the claimed design.

1 Claim, 20 Drawing Sheets

(58) **Field of Classification Search**  
 USPC ..... 138/120–124, 118, 118.1, 126, 128, 137, 138/141, 157, 109–110, 129–130; 285/47, 124.1, 124.5  
 CPC .... F16L 11/21; F16L 11/16; F16L 9/22; F16L 39/00; F16L 11/10; F16L 11/125; F16L 57/04; B29D 13/001  
 See application file for complete search history.

(56) **References Cited**

U.S. PATENT DOCUMENTS

1,798,798	A *	3/1931	Leguillon .....	F16L 11/086 138/126
D180,850	S *	8/1957	Stahl .....	D23/266
D184,225	S *	1/1959	Greizin .....	D23/266
4,675,221	A	6/1987	Lalikos et al.	
D344,822	S *	3/1994	Miller .....	D32/31
5,803,129	A *	9/1998	Coronado .....	D04C 1/06 138/125
5,894,865	A *	4/1999	Winter .....	B29C 63/18 138/121
D413,657	S *	9/1999	Lidgett .....	D23/266
D413,968	S *	9/1999	Lester .....	D23/266
6,012,742	A *	1/2000	Kocian .....	F16L 49/00 285/94
D425,184	S *	5/2000	Lidgett .....	D23/266
6,302,152	B1 *	10/2001	Mulligan .....	F16L 11/10 138/109
D478,969	S *	8/2003	Mezzalira .....	D23/266
D605,737	S *	12/2009	von Glanstaetten .....	D23/266
D642,245	S *	7/2011	Mezzalira .....	D23/266
D642,246	S *	7/2011	Mezzalira .....	D23/266
8,127,800	B2	3/2012	Ramaswamy et al.	
D724,187	S *	3/2015	Savage .....	D23/266
D731,033	S *	6/2015	Kury .....	D23/266
9,091,375	B1 *	7/2015	DeBlasi .....	F16L 11/088
D742,604	S *	11/2015	Kim .....	D32/31
D743,658	S *	11/2015	Kim .....	D32/31
2006/0151043	A1 *	7/2006	Nanney .....	B32B 1/08 138/125
2008/0190506	A1 *	8/2008	Cleveland .....	F16L 57/04 138/110
2013/0092276	A1 *	4/2013	Caneva .....	D04B 21/205 138/123
2015/0136269	A1 *	5/2015	Chung .....	F16L 11/24 138/124

\* cited by examiner

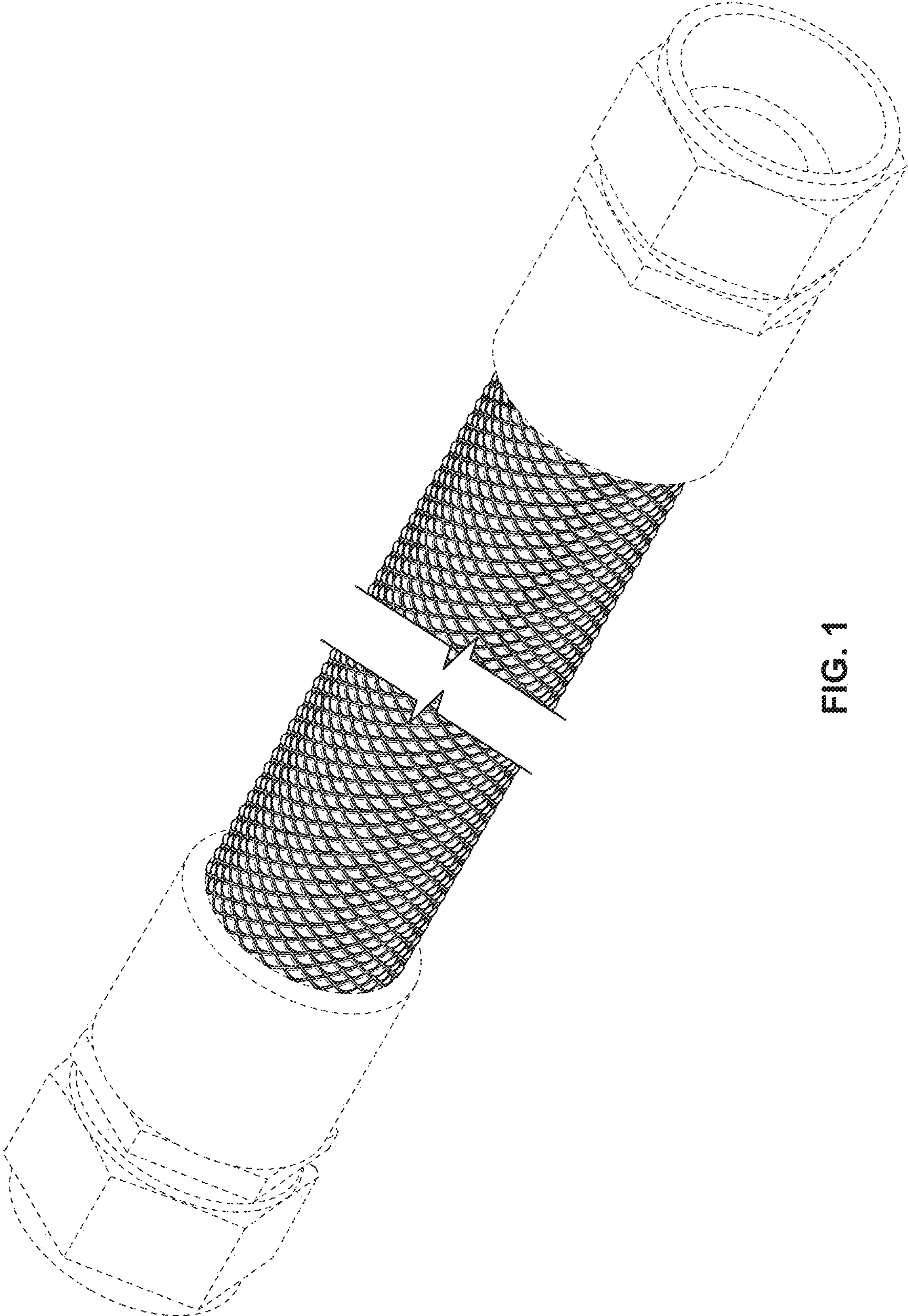

FIG. 1

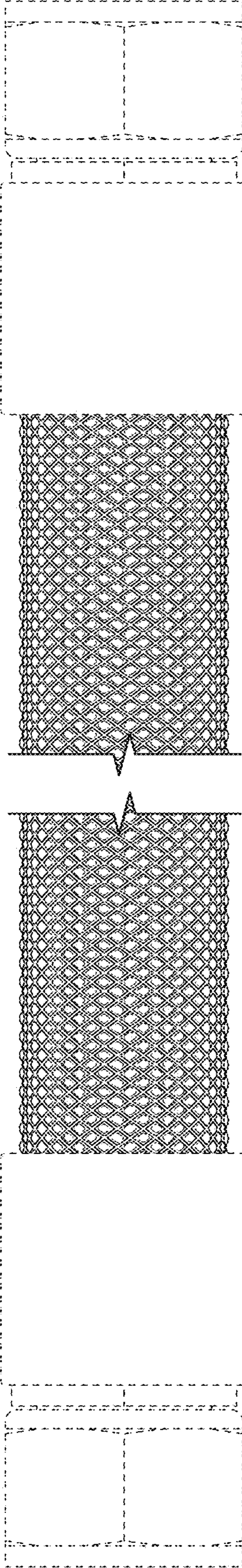

FIG. 2

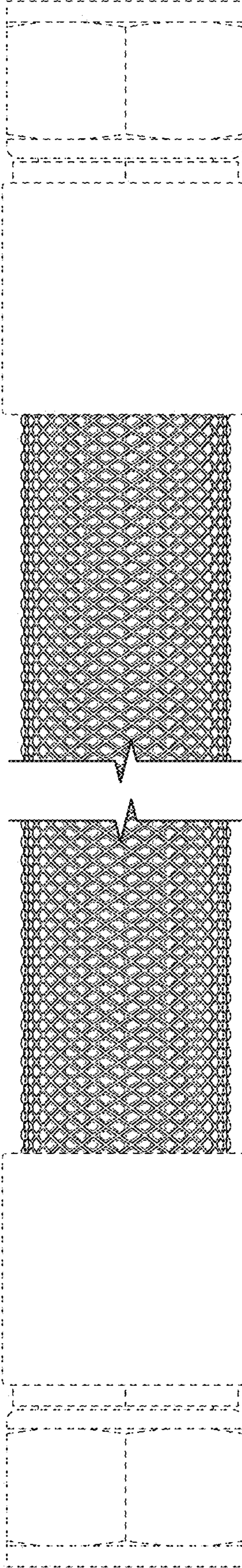

FIG. 3

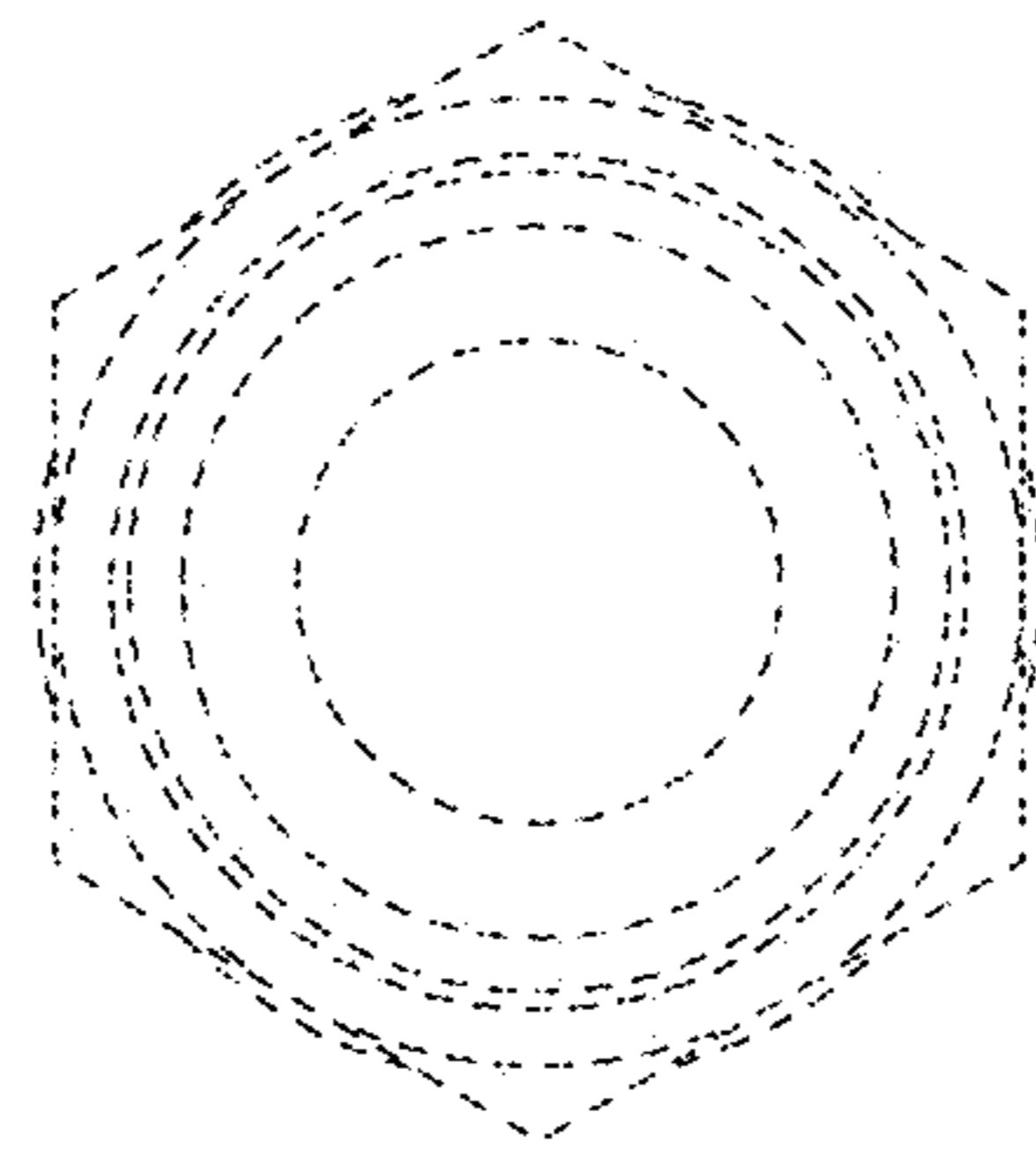

FIG. 5

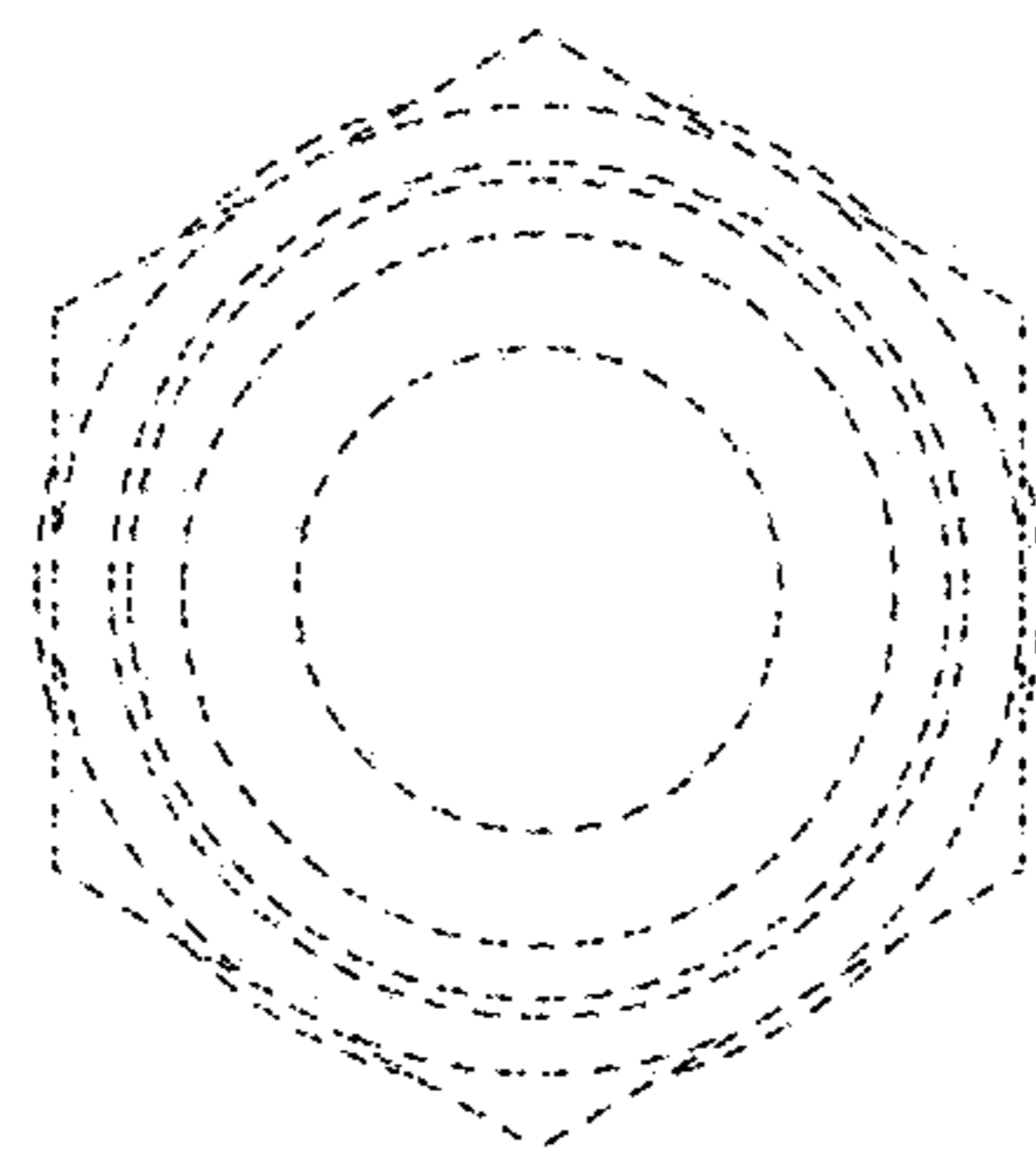

FIG. 4

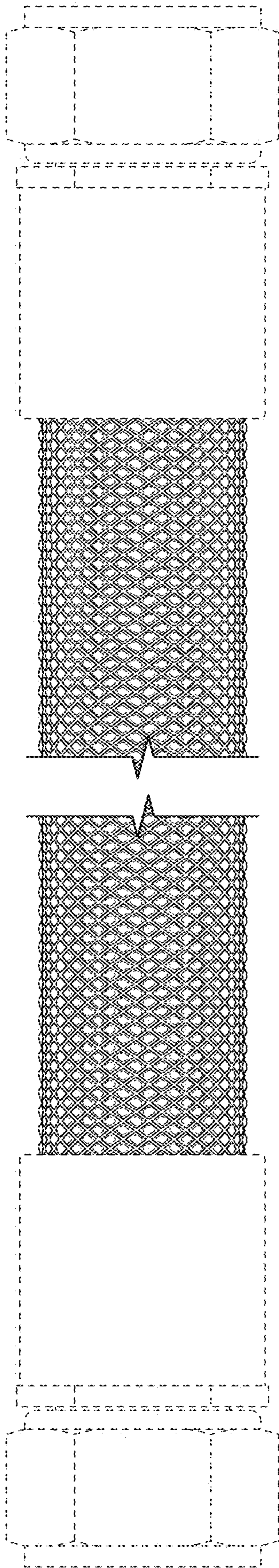

FIG. 6

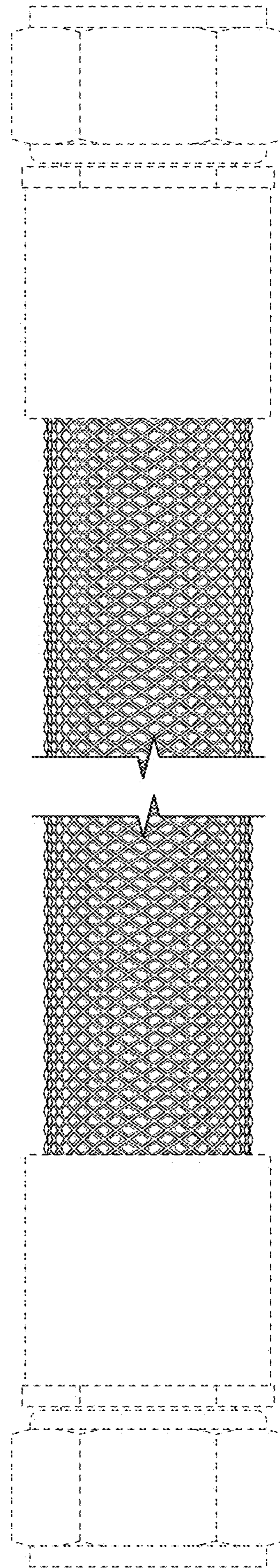

FIG. 7

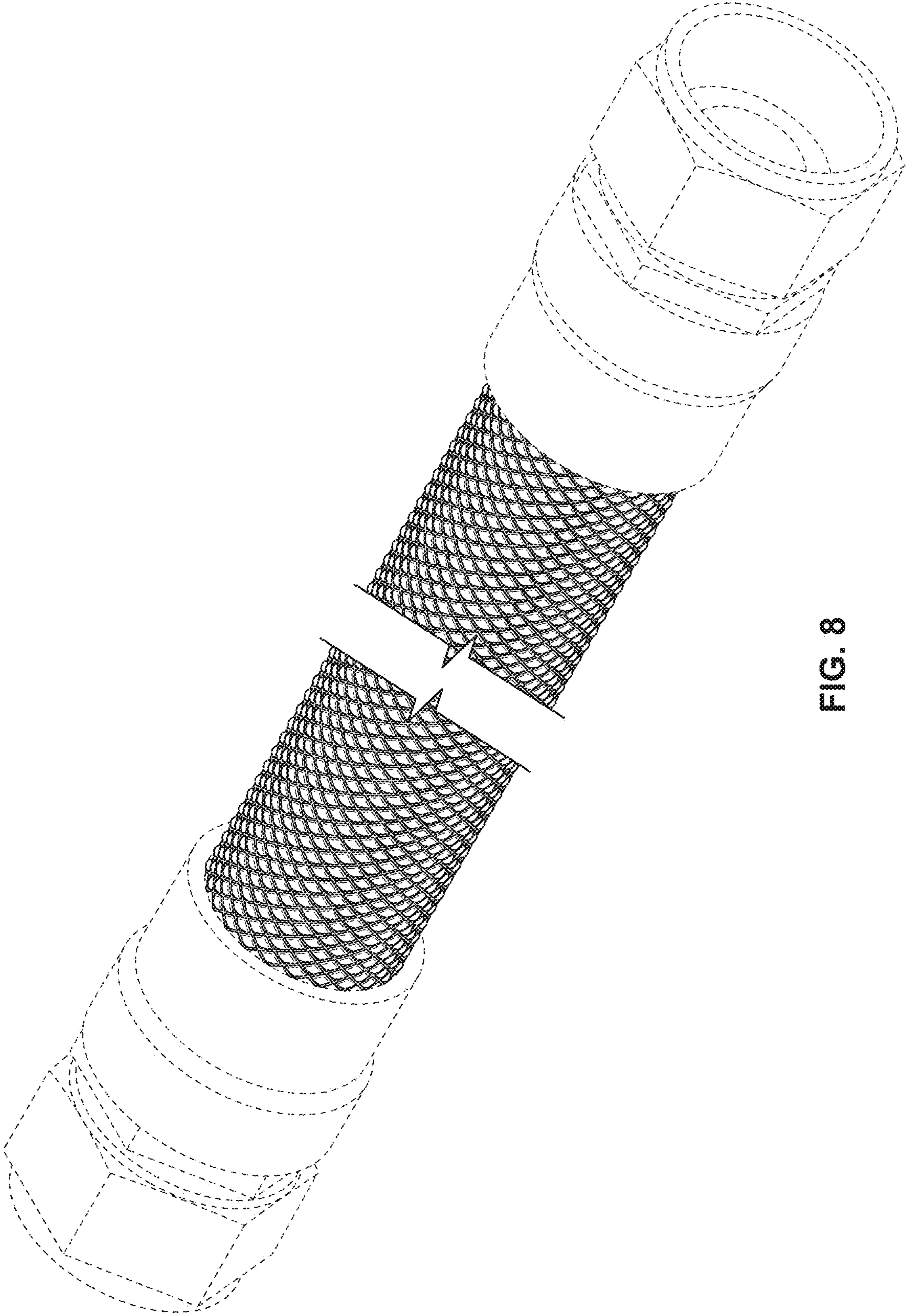

FIG. 8

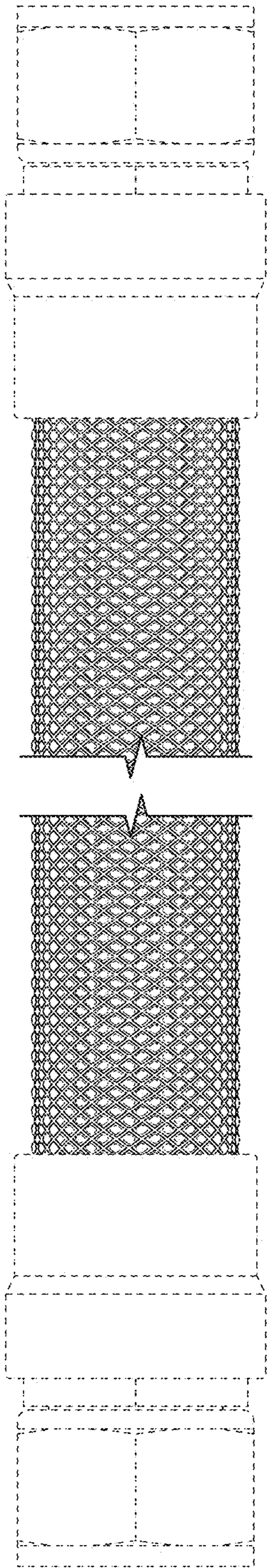

FIG. 9

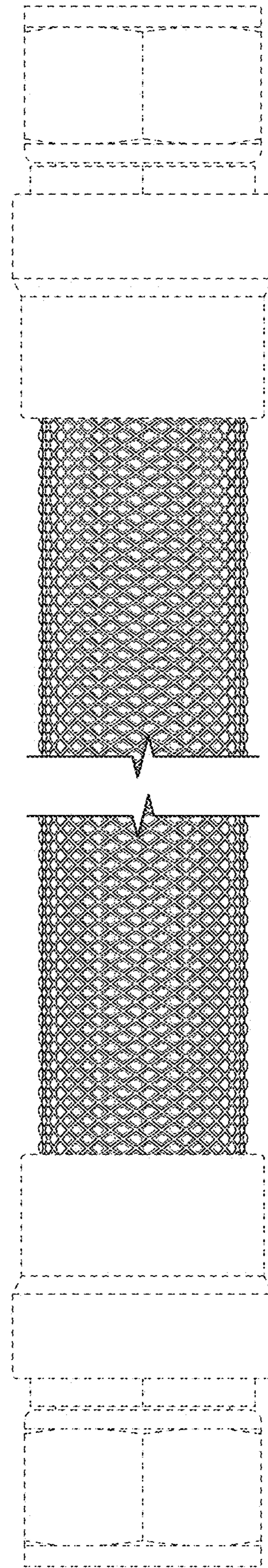

FIG. 10



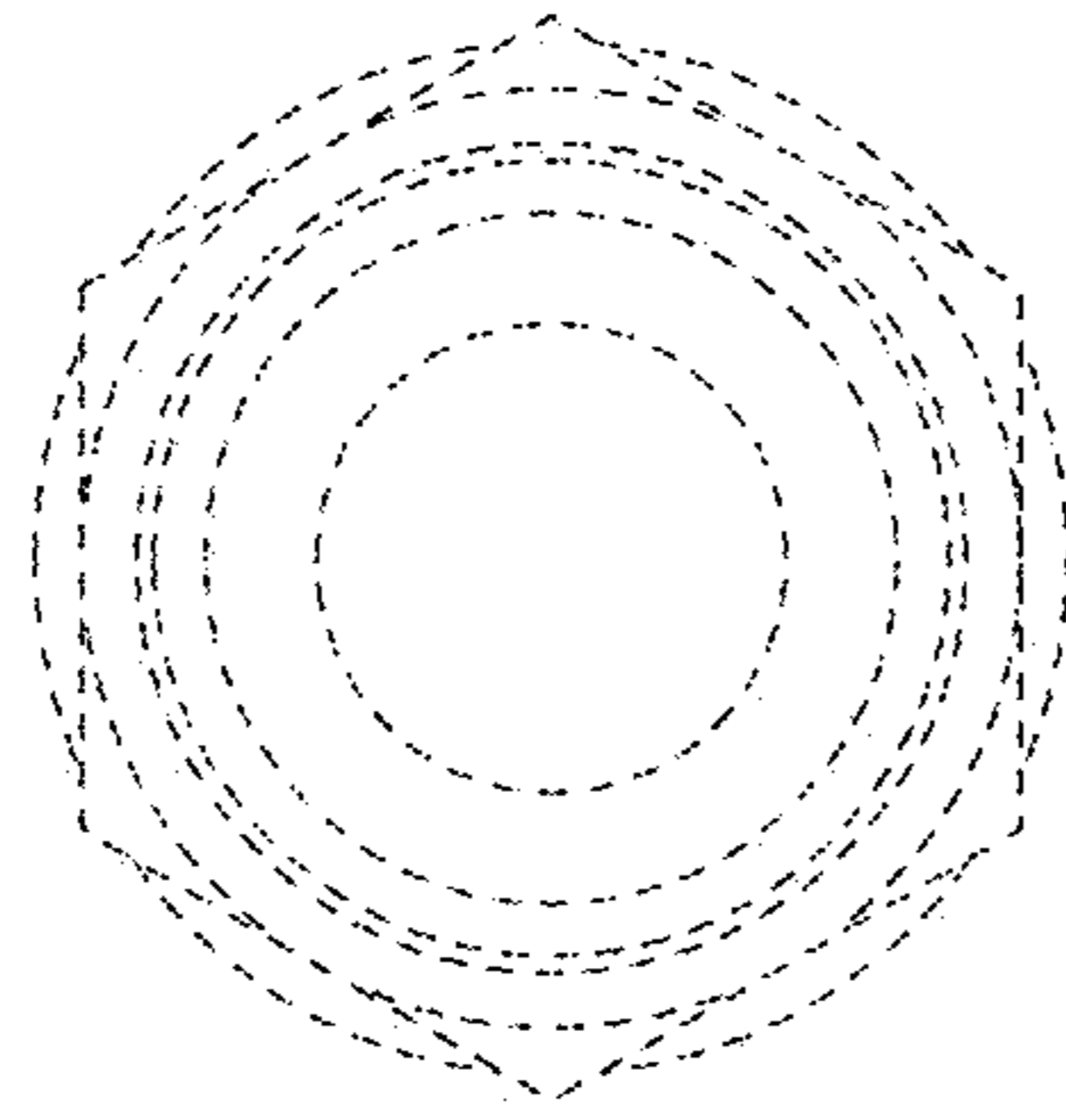

FIG. 12

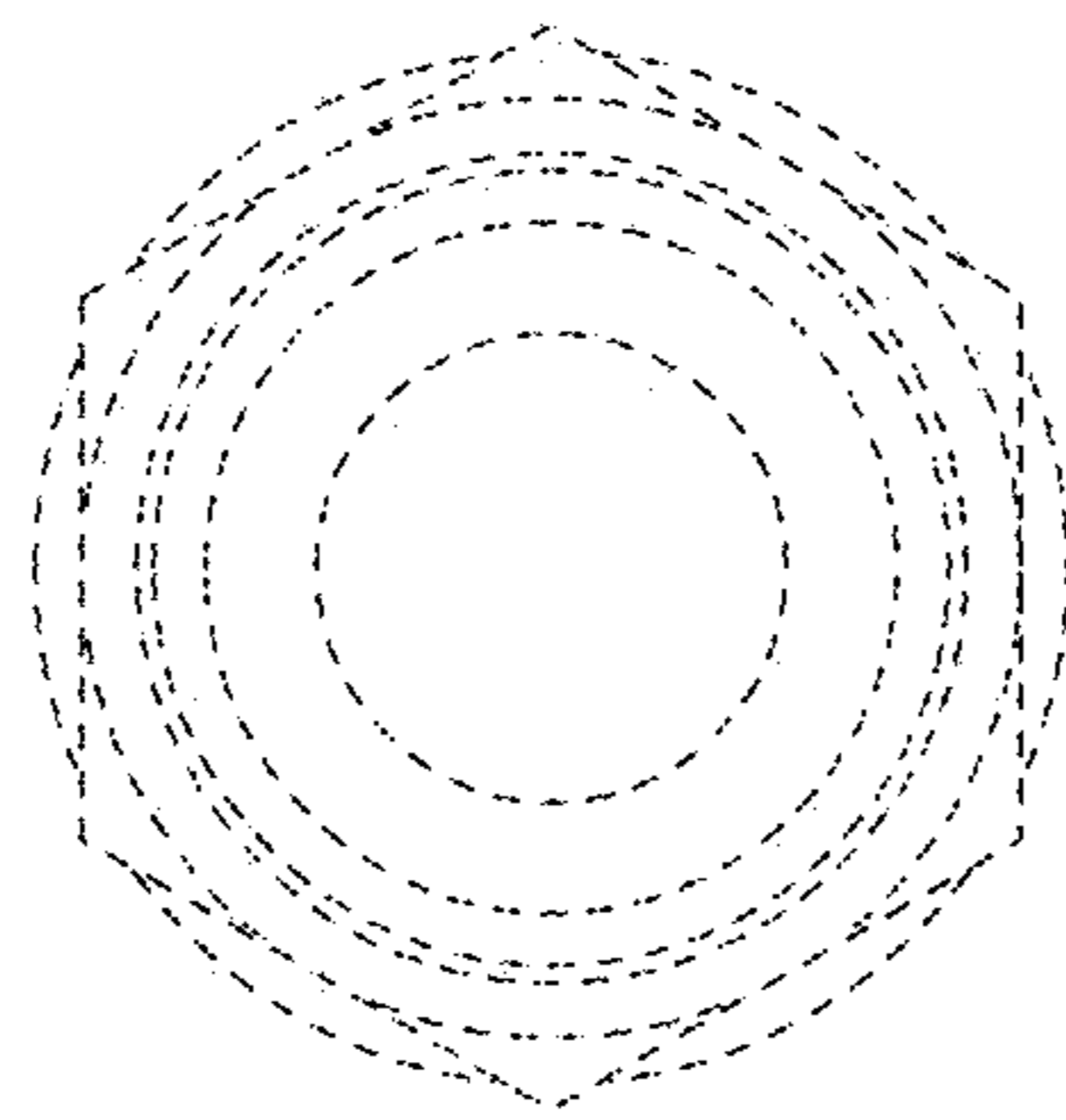

FIG. 11

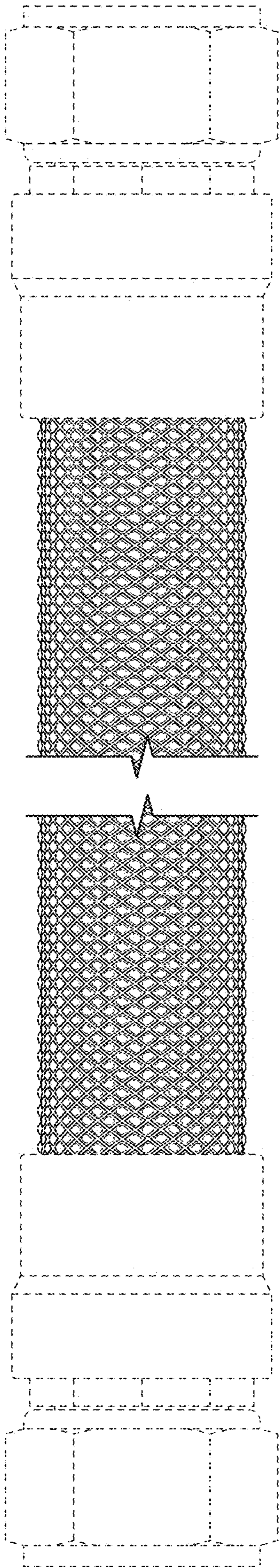

FIG. 13

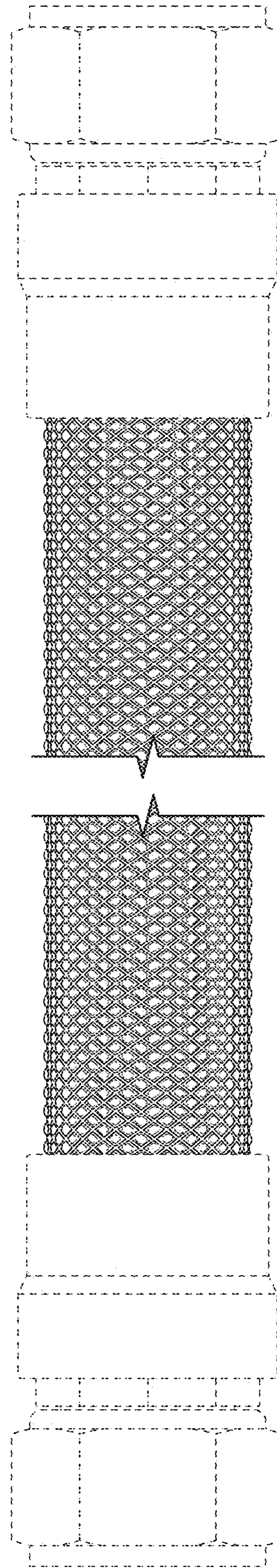

FIG. 14

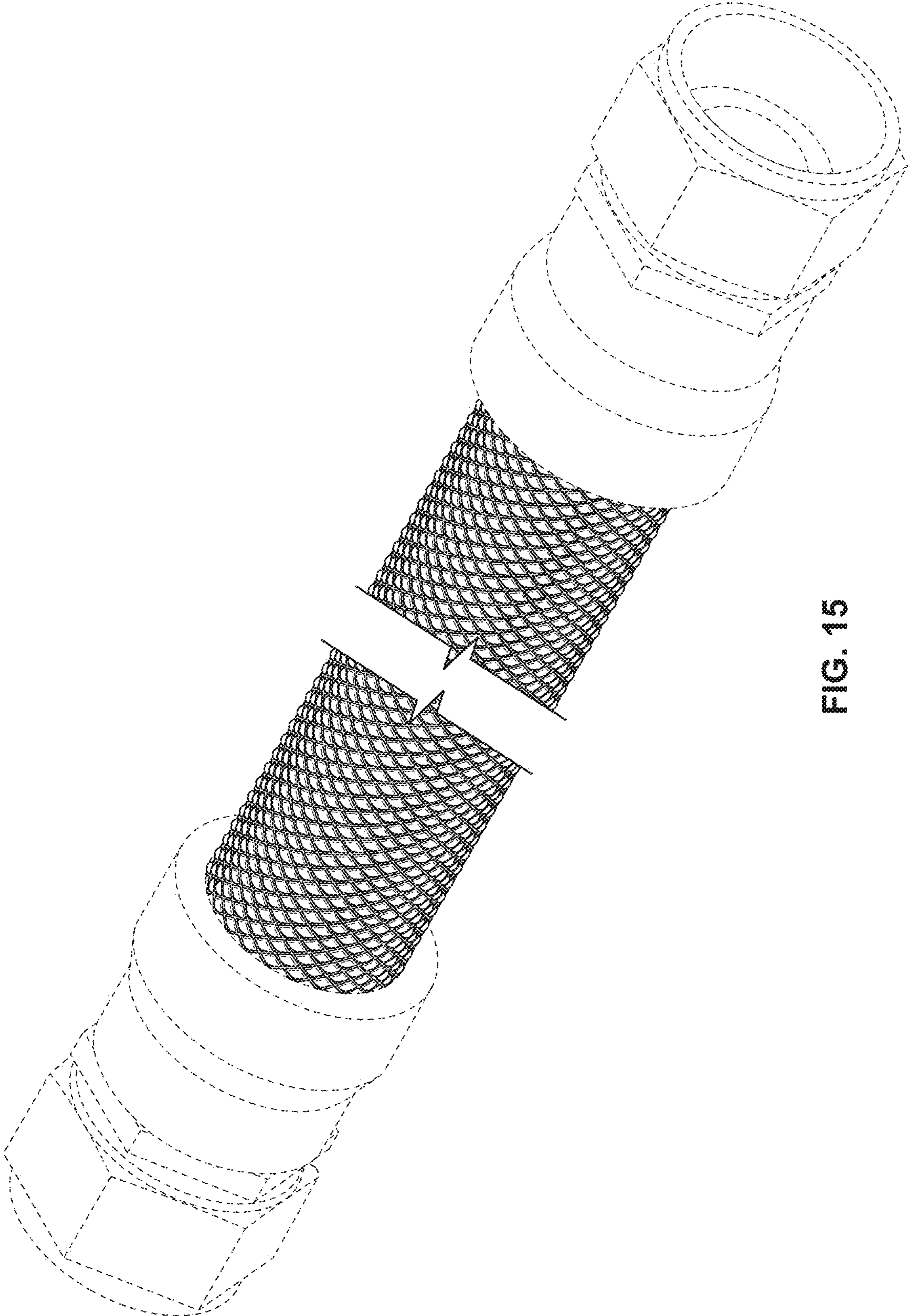

FIG. 15

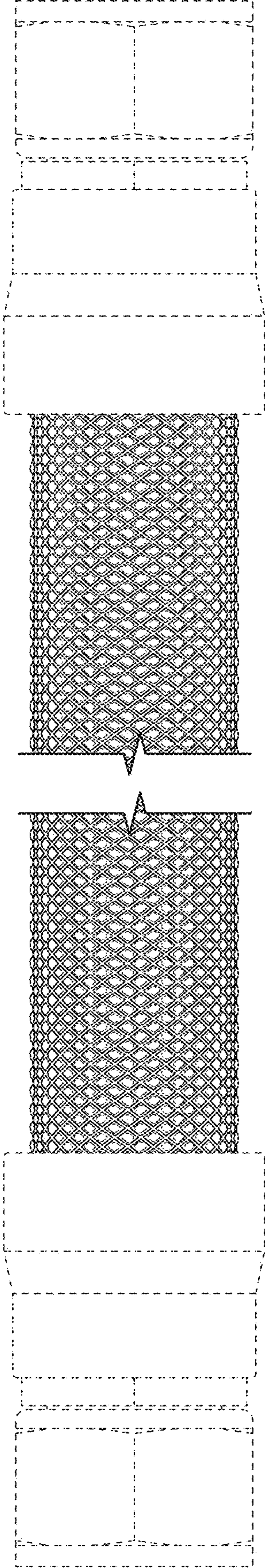

FIG. 16

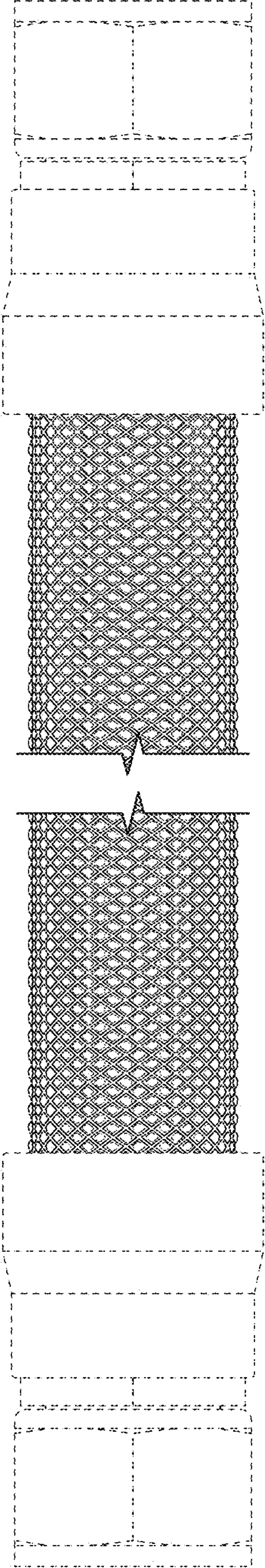

FIG. 17

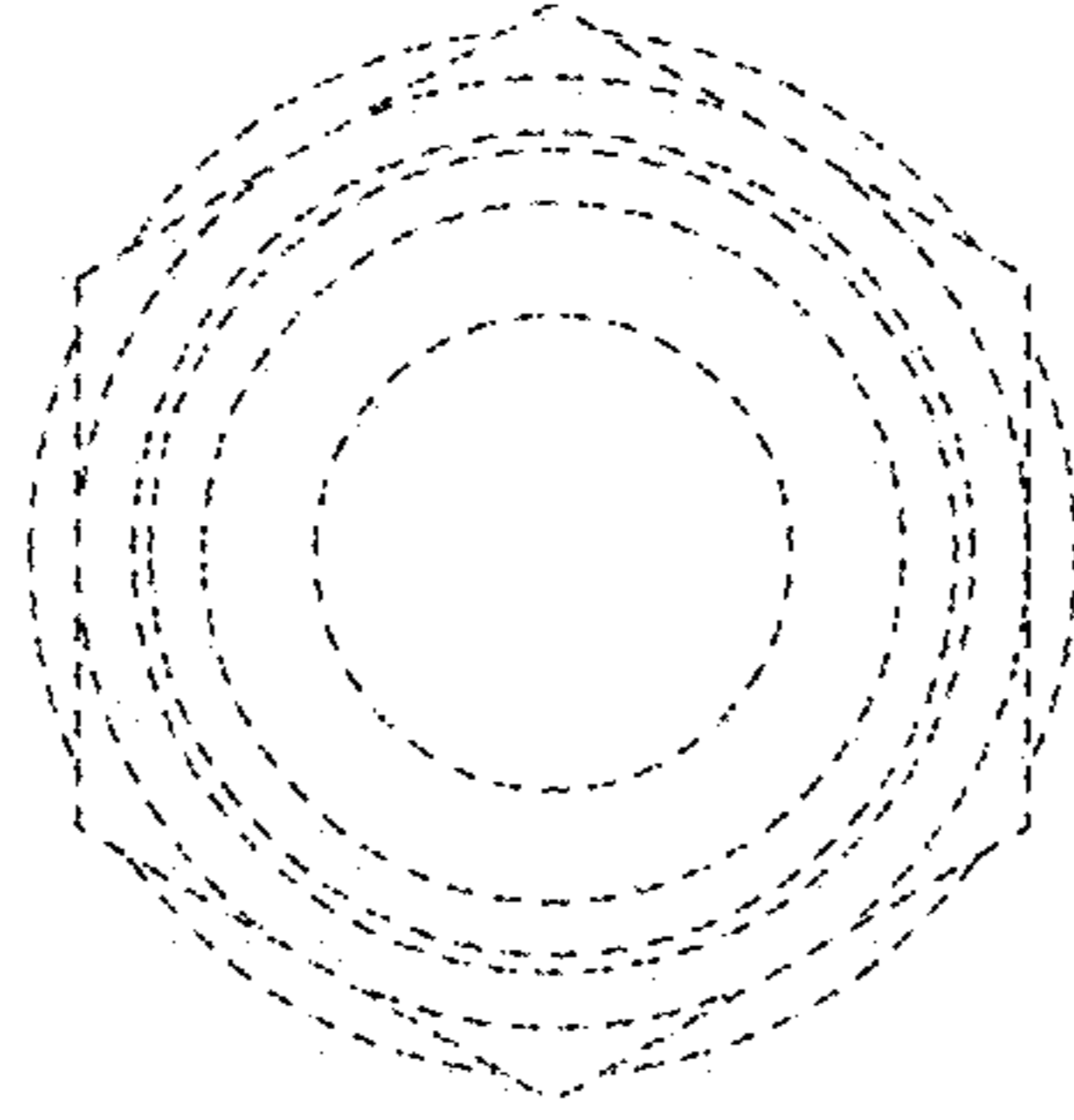

FIG. 19

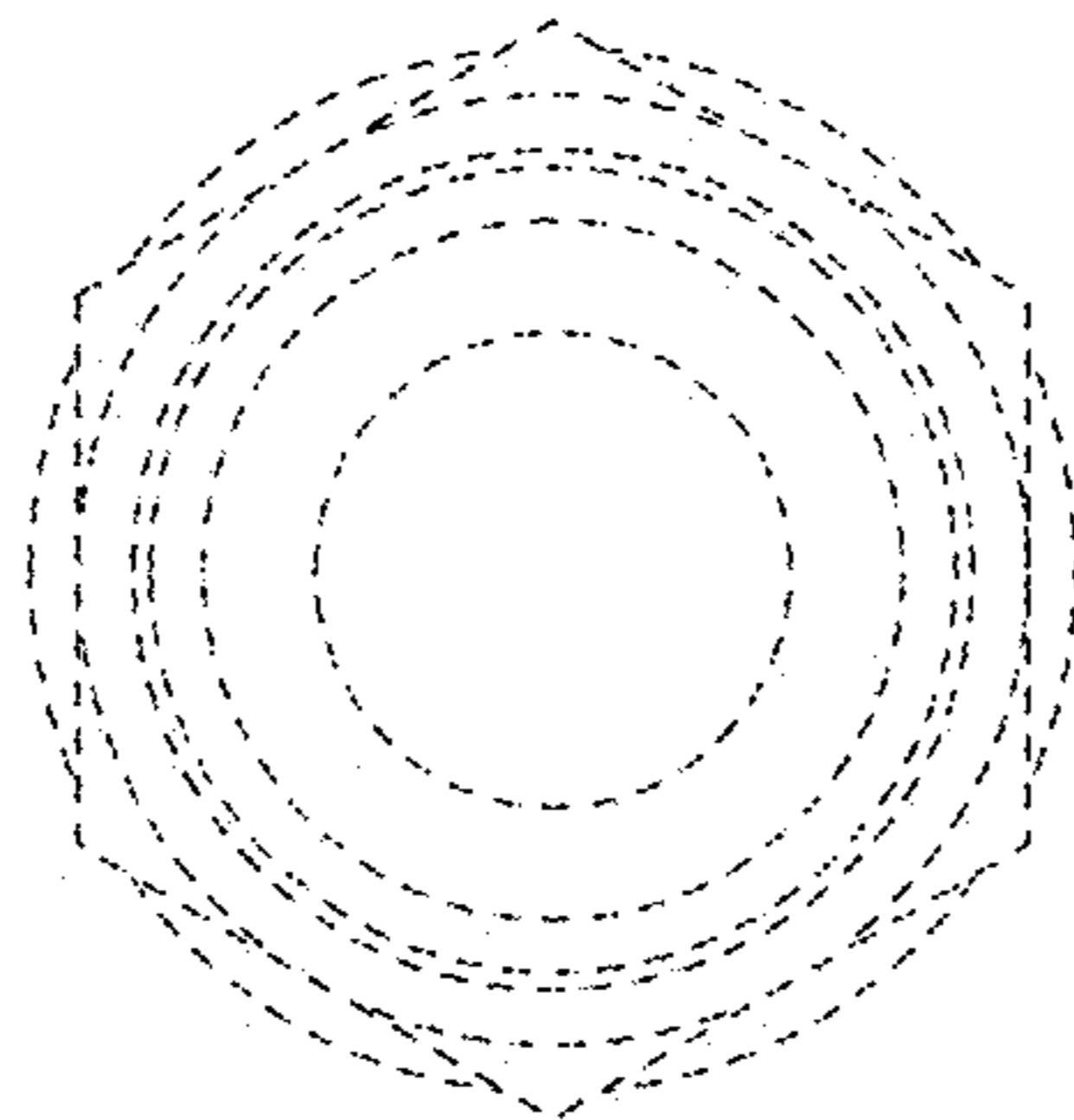

FIG. 18

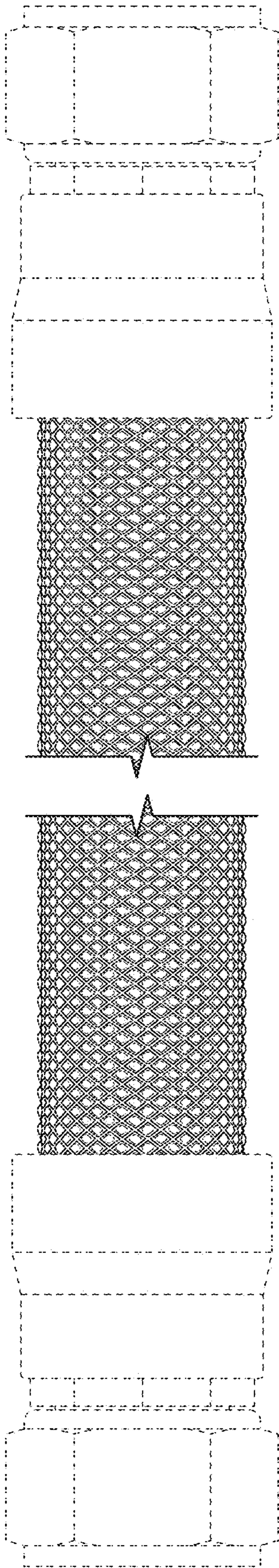

FIG. 20

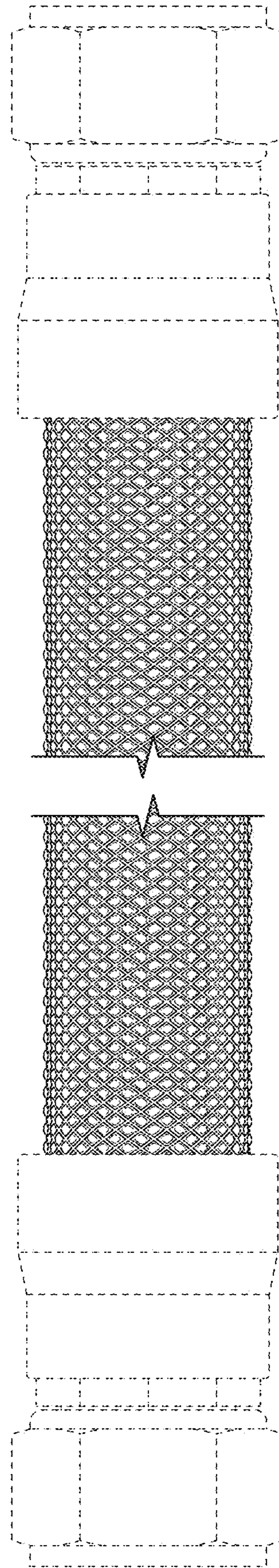

FIG. 21

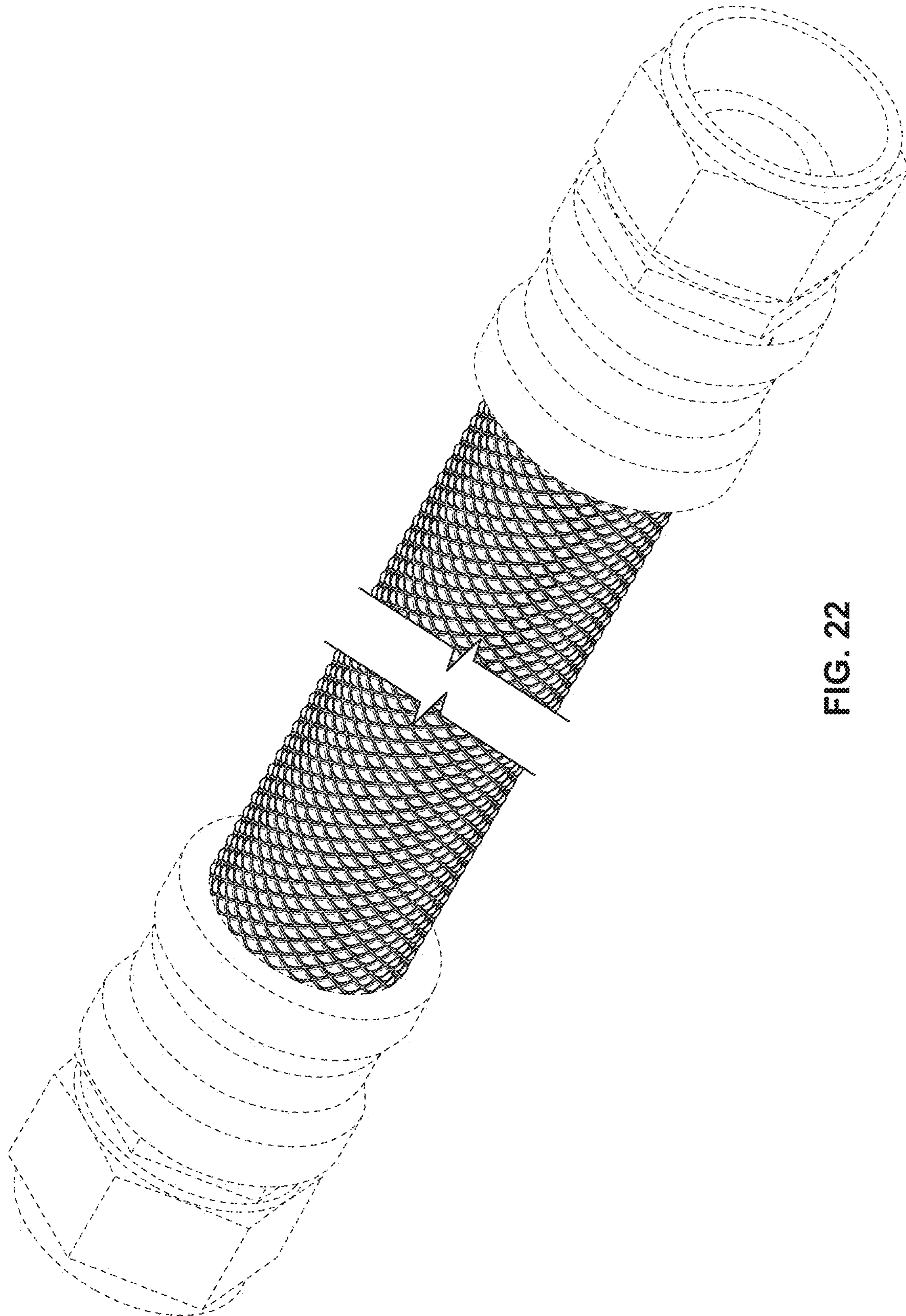

FIG. 22

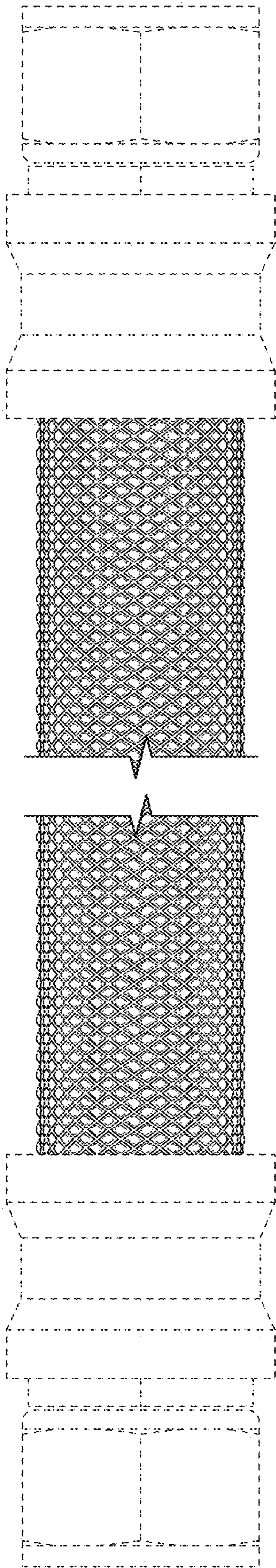

FIG. 23

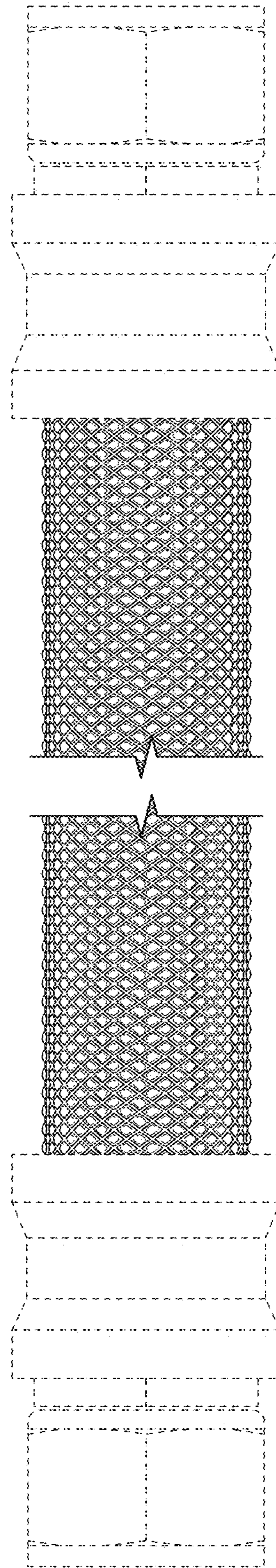

FIG. 24



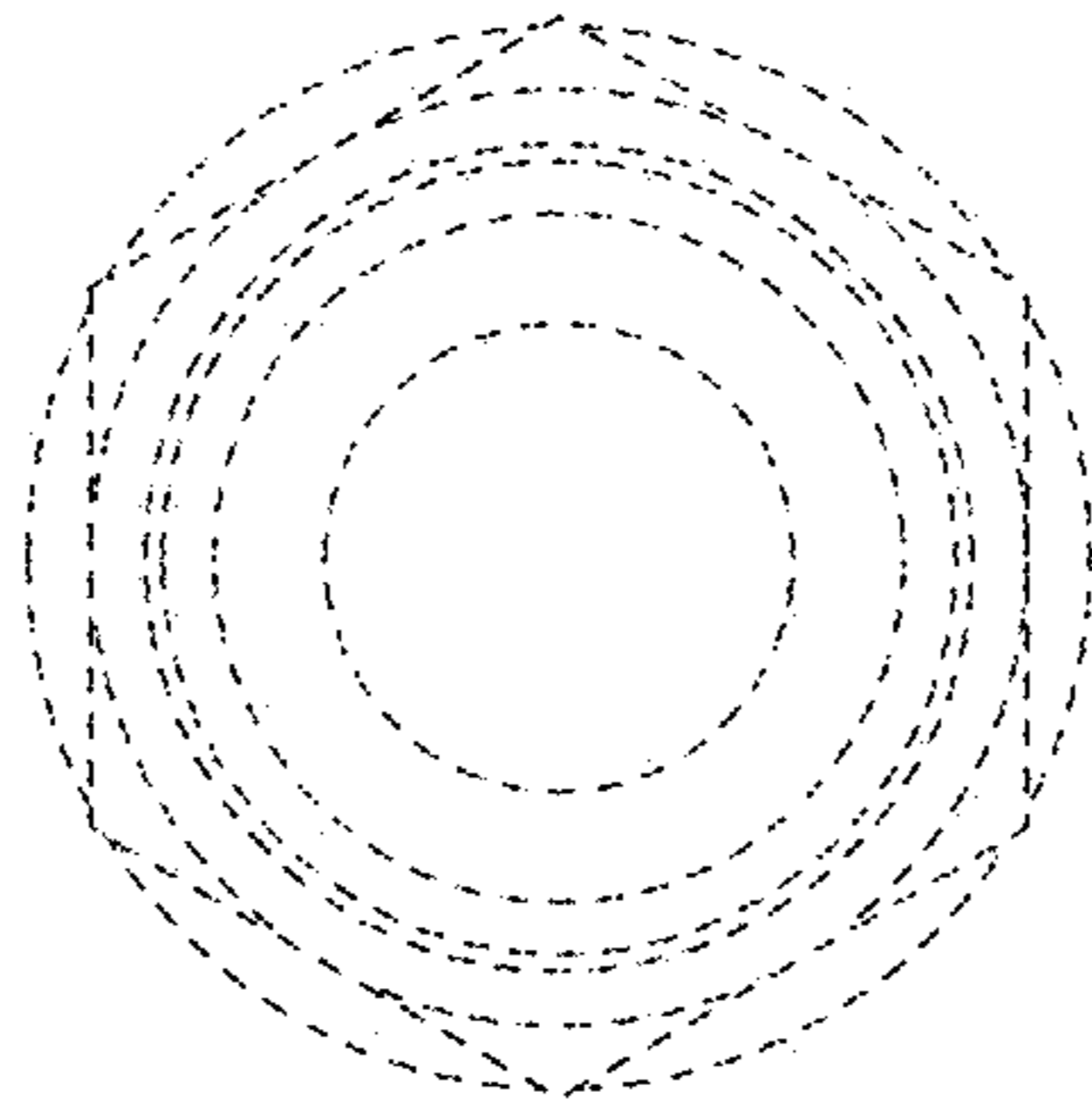

FIG. 25

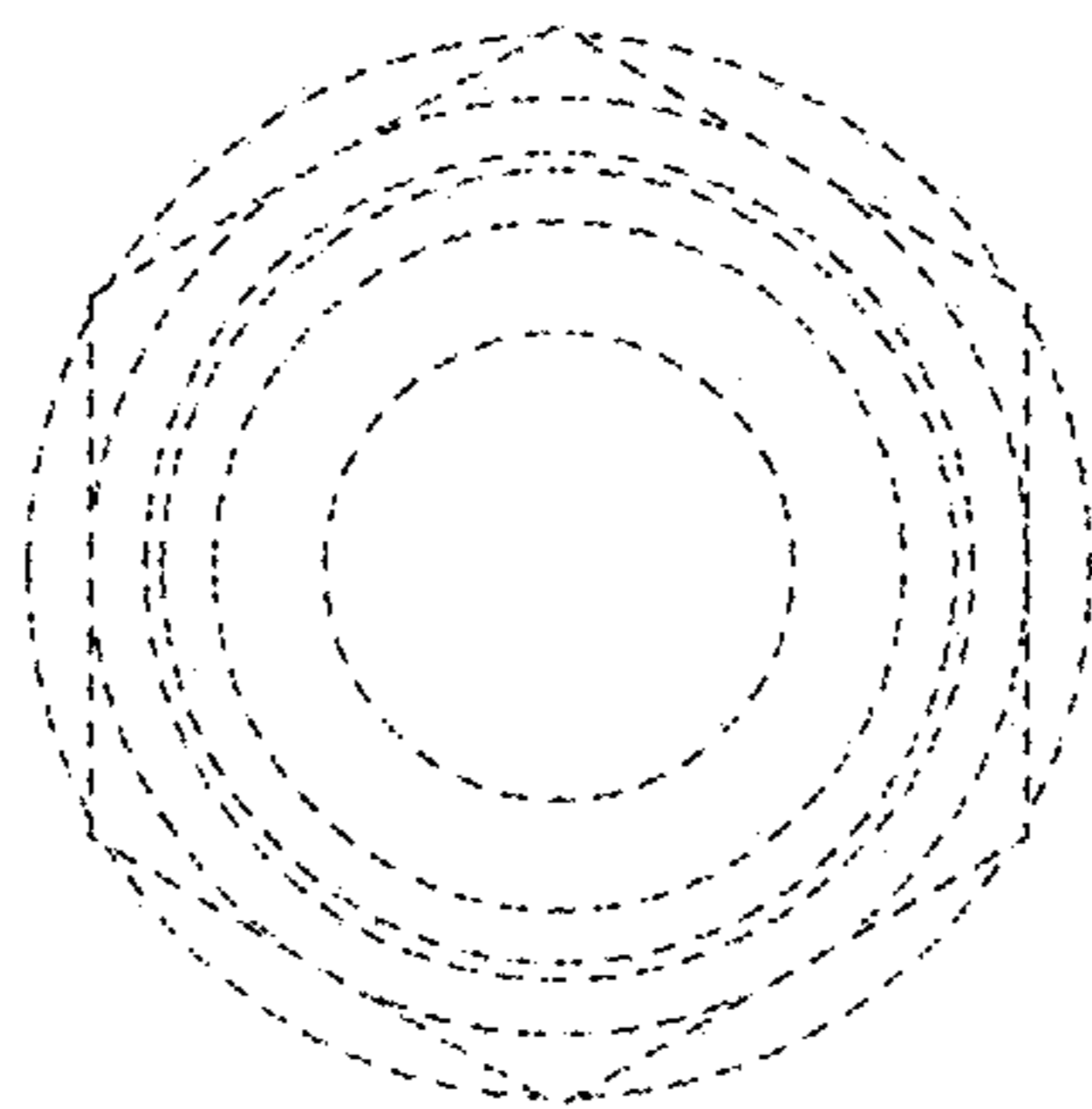

FIG. 26

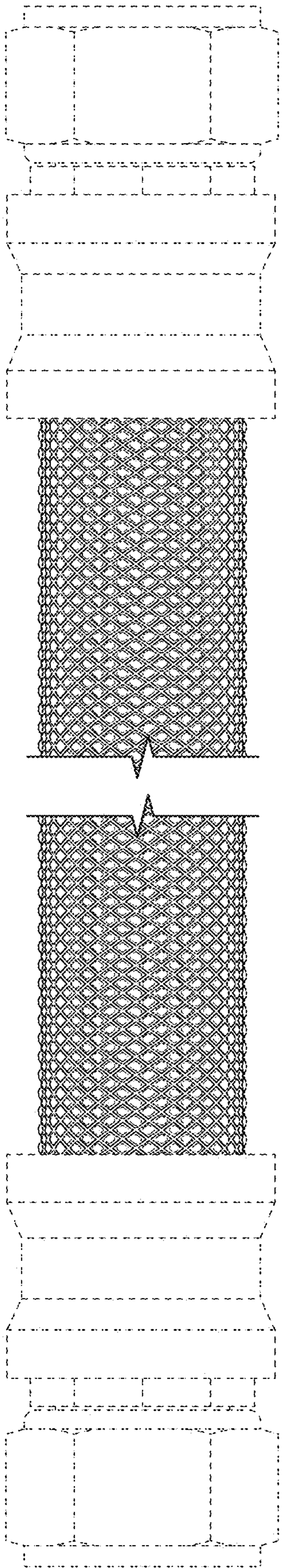

FIG. 27

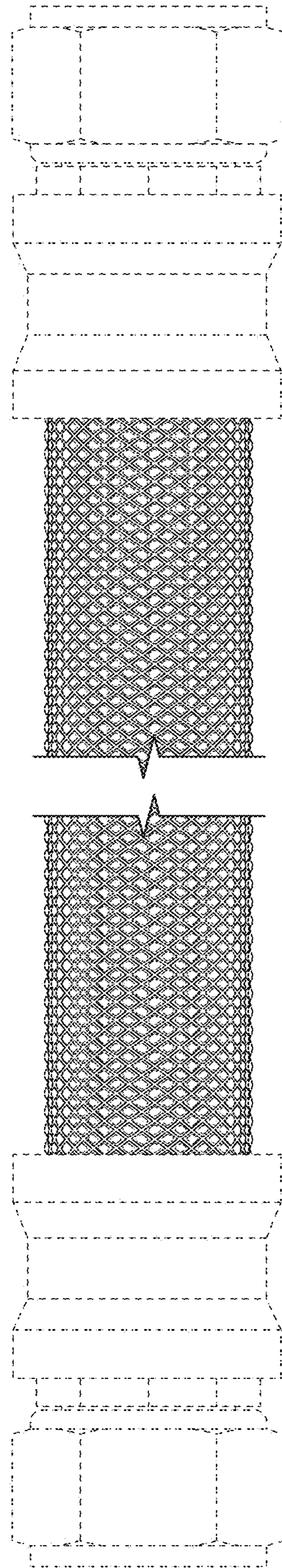

FIG. 28

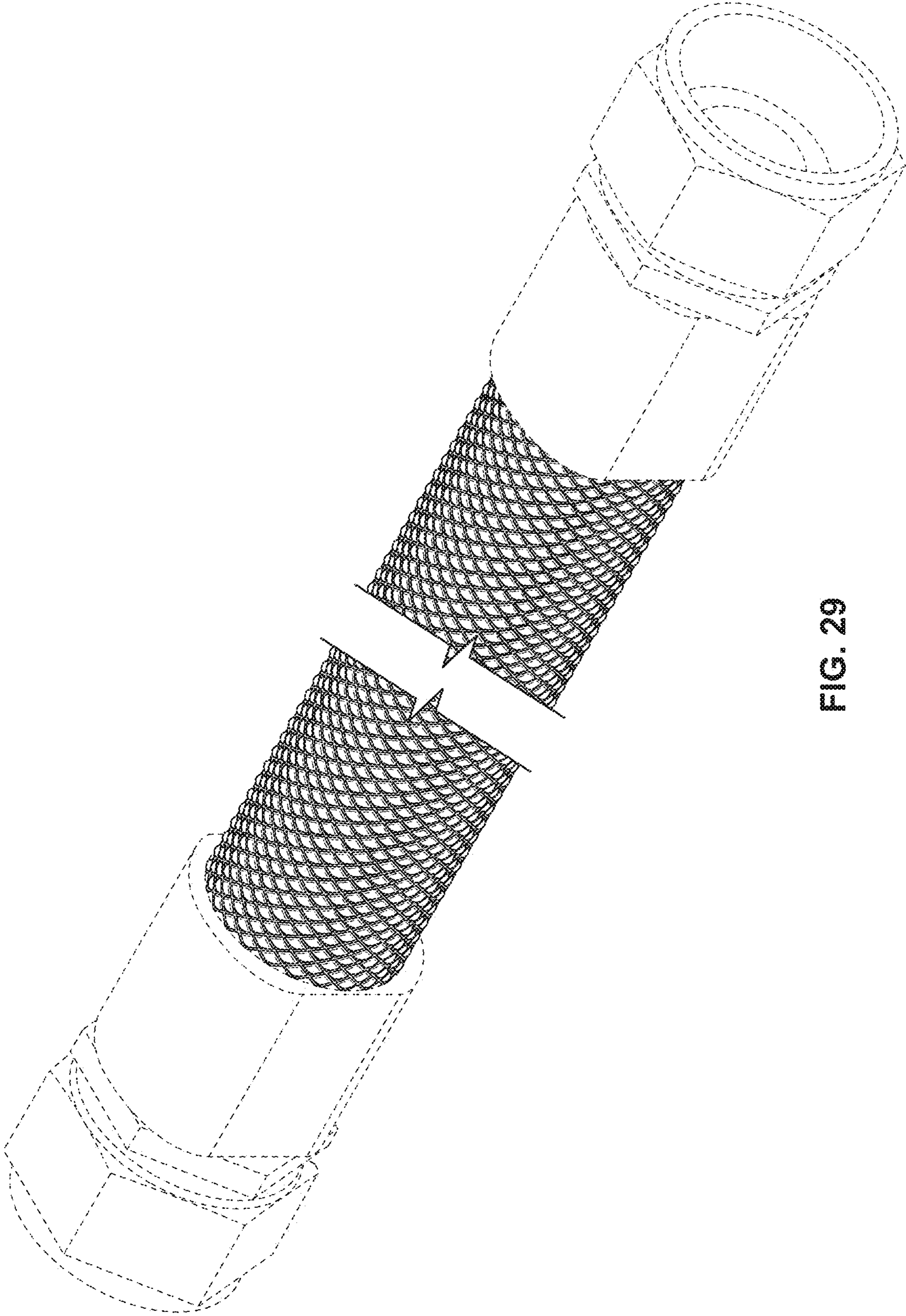

FIG. 29

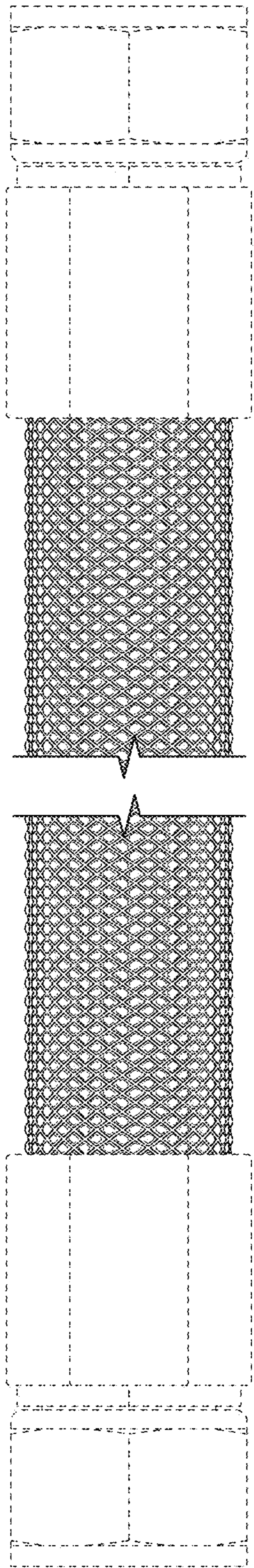

FIG. 30

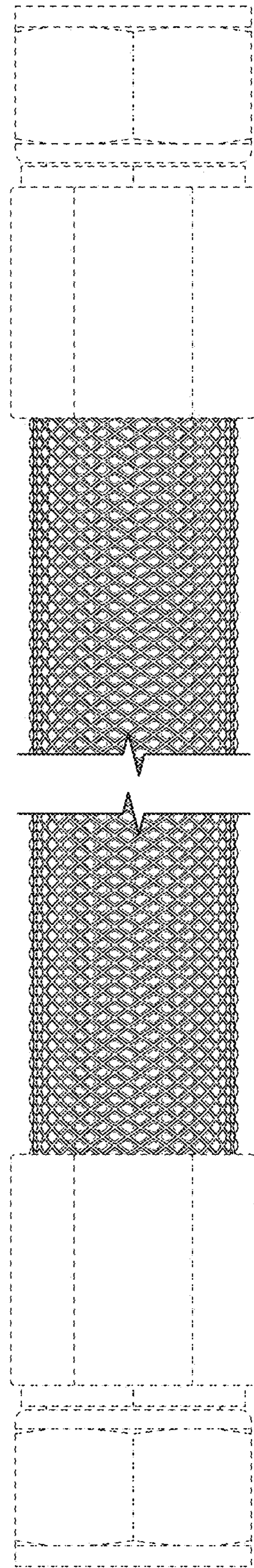

FIG. 31

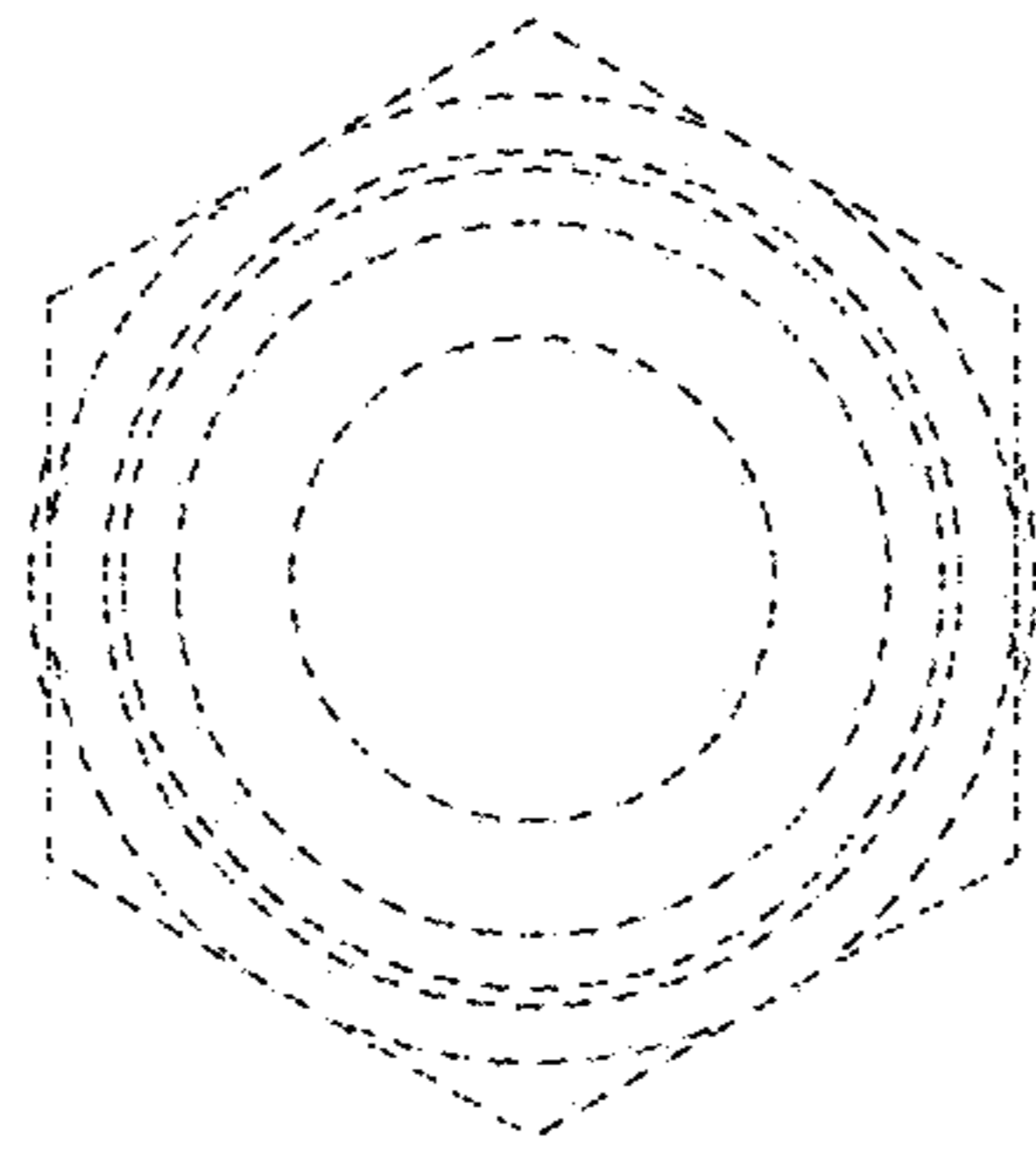

FIG. 33

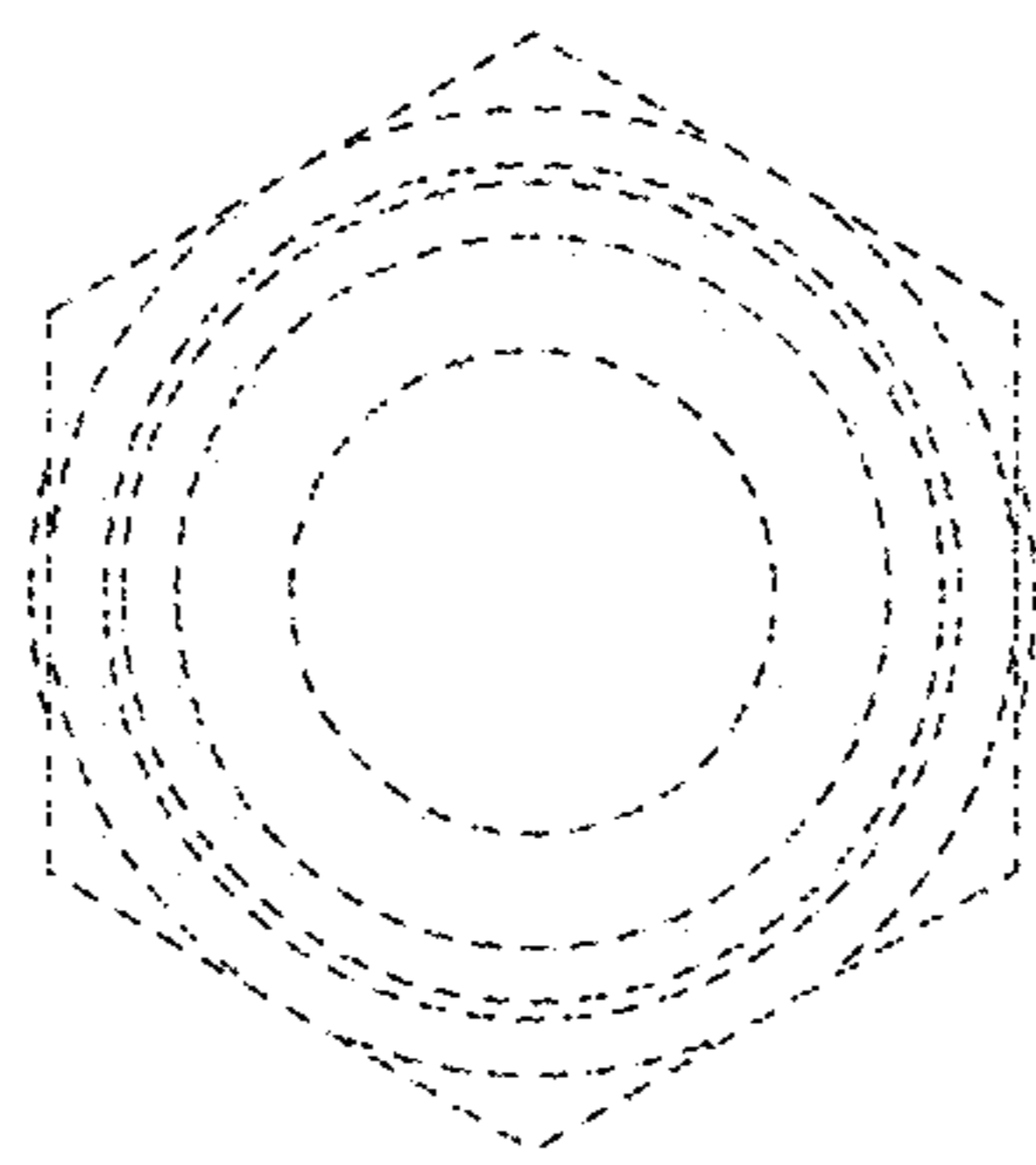

FIG. 32

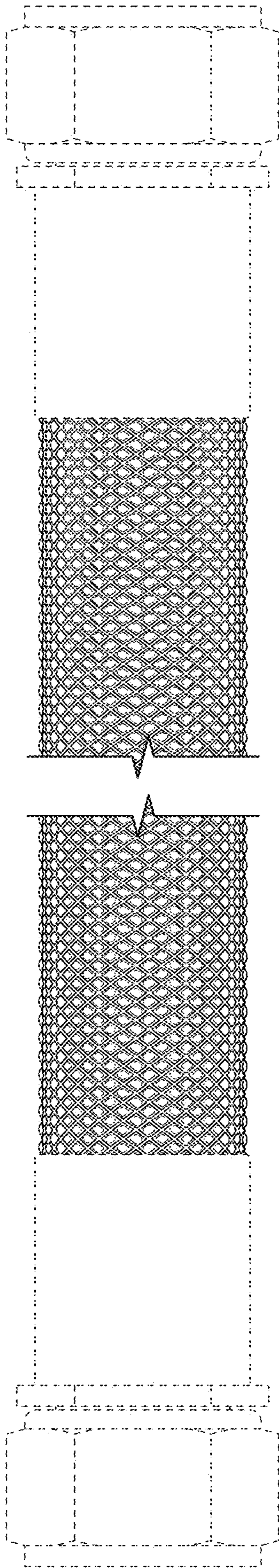

FIG. 34

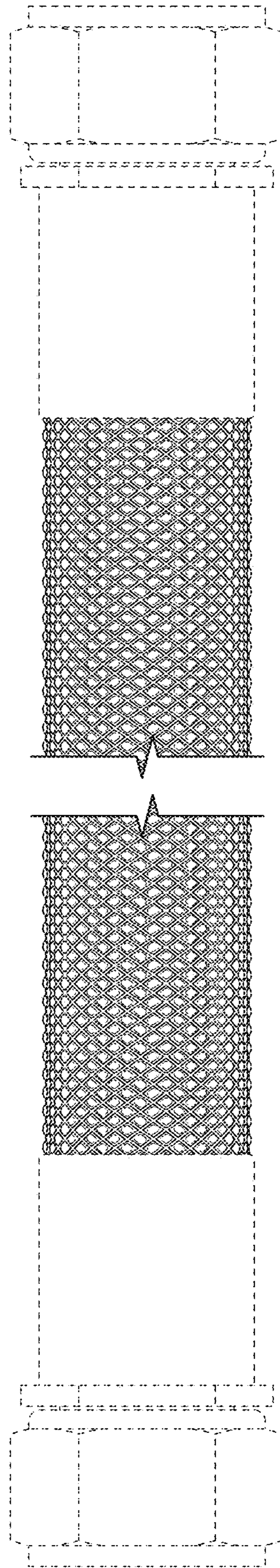

FIG. 35