



US00D942548S

(12) **United States Design Patent** (10) **Patent No.:** **US D942,548 S**
Peeters et al. (45) **Date of Patent:** **** Feb. 1, 2022**

(54) **GAME BOARD WITH GAME PIECES**

(71) Applicant: **SMART N.V.**, Kontich (BE)
 (72) Inventors: **Raf Peeters**, Lier (BE); **Leighton Meredith Rees**, Cirencester (GB)

(73) Assignee: **SMART N.V.**, Kontich (BE)

(**) Term: **15 Years**

(21) Appl. No.: **29/687,594**

(22) Filed: **Apr. 14, 2019**

(30) **Foreign Application Priority Data**

Oct. 30, 2018 (EP) 005813094

(51) **LOC (13) Cl.** **21-01**

(52) **U.S. Cl.**
USPC **D21/360**

(58) **Field of Classification Search**
 USPC D9/430-432; D21/300, 334, 335, 360,
 D21/363, 365, 370, 385-389, 392-395,
 (Continued)

(56) **References Cited**

U.S. PATENT DOCUMENTS

D147,899 S * 11/1947 Falk D7/595
 D155,086 S * 9/1949 Goldfarb D21/585
 (Continued)

Primary Examiner — George D. Kirschbaum

Assistant Examiner — Joseph J. Kukella

(74) *Attorney, Agent, or Firm* — Hodgson Russ LLP

(57) **CLAIM**

The ornamental design for a game board with game pieces, as shown and described.

DESCRIPTION

FIG. 1 is a top perspective view of a game board with game pieces showing a first game piece apart from the game board for ease of illustration;

FIG. 2 is a front elevational view of the game piece of FIG. 1;

FIG. 3 is a rear elevational view of the game piece of FIG. 1;

FIG. 4 is a right side view of the game piece of FIG. 1;

FIG. 5 is a left side view of the game piece of FIG. 1;

FIG. 6 is a top view of the game piece of FIG. 1;

FIG. 7 is a bottom view of the game piece of FIG. 1;

FIG. 8 is a top perspective view of a game board with game pieces showing a second game piece apart from the game board for ease of illustration;

FIG. 9 is a front elevational view of the game piece of FIG. 8;

FIG. 10 is a rear elevational view of the game piece of FIG. 8;

FIG. 11 is a right side view of the game piece of FIG. 8;

FIG. 12 is a left side view of the game piece of FIG. 8;

FIG. 13 is a top view of the game piece of FIG. 8;

FIG. 14 is a bottom view of the game piece of FIG. 8;

FIG. 15 is a top perspective view of a game board with game pieces showing a third game piece apart from the game board for ease of illustration;

FIG. 16 is a front elevational view of the game piece of FIG. 15;

FIG. 17 is a rear elevational view of the game piece of FIG. 15;

FIG. 18 is a right side view of the game piece of FIG. 15;

FIG. 19 is a left side view of the game piece of FIG. 15;

FIG. 20 is a top view of the game piece of FIG. 15;

FIG. 21 is a bottom view of the game piece of FIG. 15;

FIG. 22 is a top perspective view of a game board with game pieces showing a fourth game piece apart from the game board for ease of illustration;

FIG. 23 is a front elevational view of the game piece of FIG. 22;

FIG. 24 is a rear elevational view of the game piece of FIG. 22;

FIG. 25 is a right side view of the game piece of FIG. 22;

FIG. 26 is a left side view of the game piece of FIG. 22;

FIG. 27 is a top view of the game piece of FIG. 22;

FIG. 28 is a bottom view of the game piece of FIG. 22;

(Continued)

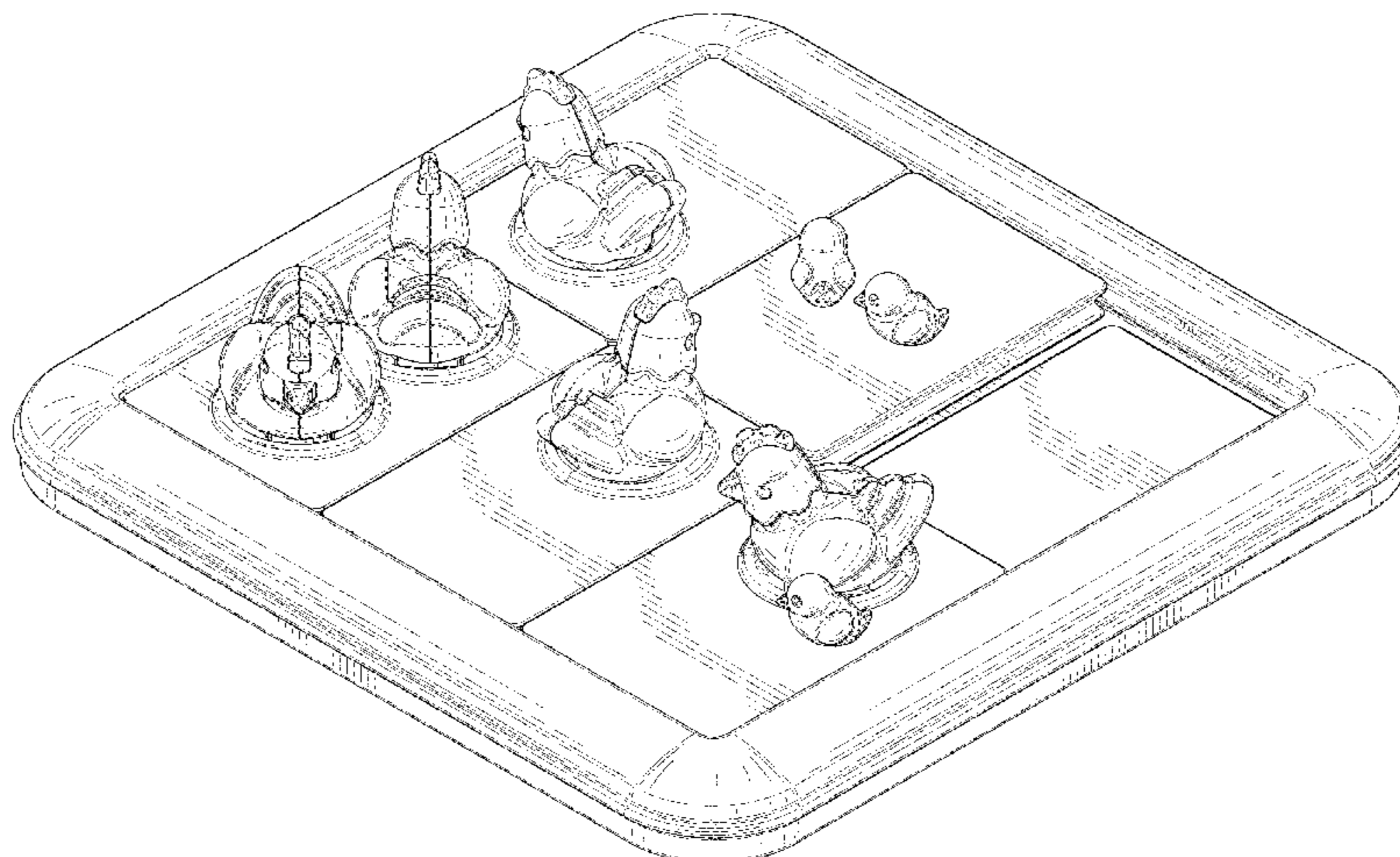

FIG. 29 is a top perspective view of a game board with game pieces showing a fifth game piece apart from the game board for ease of illustration;

FIG. 30 is a front elevational view of the game piece of FIG. 29;

FIG. 31 is a rear elevational view of the game piece of FIG. 29;

FIG. 32 is a right side view of the game piece of FIG. 29;

FIG. 33 is a left side view of the game piece of FIG. 29;

FIG. 34 is a top view of the game piece of FIG. 29;

FIG. 35 is a bottom view of the game piece of FIG. 29;

FIG. 36 is a top perspective view of a game board with game pieces showing the game board apart from the game pieces for ease of illustration;

FIG. 37 is a front elevational view of the game board of FIG. 36;

FIG. 38 is a rear elevational view of the game board of FIG. 36;

FIG. 39 is a right side view of the game board of FIG. 36;

FIG. 40 is a left side view of the game board of FIG. 36;

FIG. 41 is a top view of the game board of FIG. 36;

FIG. 42 is a bottom view of the game board of FIG. 36; and,

FIG. 43 is a top perspective view of a game board with game pieces showing our new design.

The evenly-dashed broken lines in the drawings illustrate portions of the game board with game pieces that form no part of the claimed design.

1 Claim, 35 Drawing Sheets

(58) **Field of Classification Search**

USPC D21/397, 484, 487, 499, 576, 595, 599,
D21/600, 609
CPC A63F 7/0017; A63F 7/0023; A63F 9/20
See application file for complete search history.

(56) **References Cited**

U.S. PATENT DOCUMENTS

D184,457 S *	2/1959	Reed	A47D 13/086
			D21/609
D232,996 S *	10/1974	Snyder	D7/302
D247,258 S *	2/1978	Nakao	D21/595
D274,071 S *	5/1984	Emms	D21/595
D279,308 S *	6/1985	Marschak	D21/609
D295,774 S *	5/1988	Zinter-Chahin	D11/162
D532,463 S *	11/2006	Boutin	A47D 13/086
			D21/609
D667,506 S *	9/2012	Peeters	D21/478
D778,776 S *	2/2017	Weiser	D11/162
D822,131 S *	7/2018	Mason	D21/609
D874,573 S *	2/2020	Ford	D21/360
D897,449 S *	9/2020	Xu	D21/468

* cited by examiner

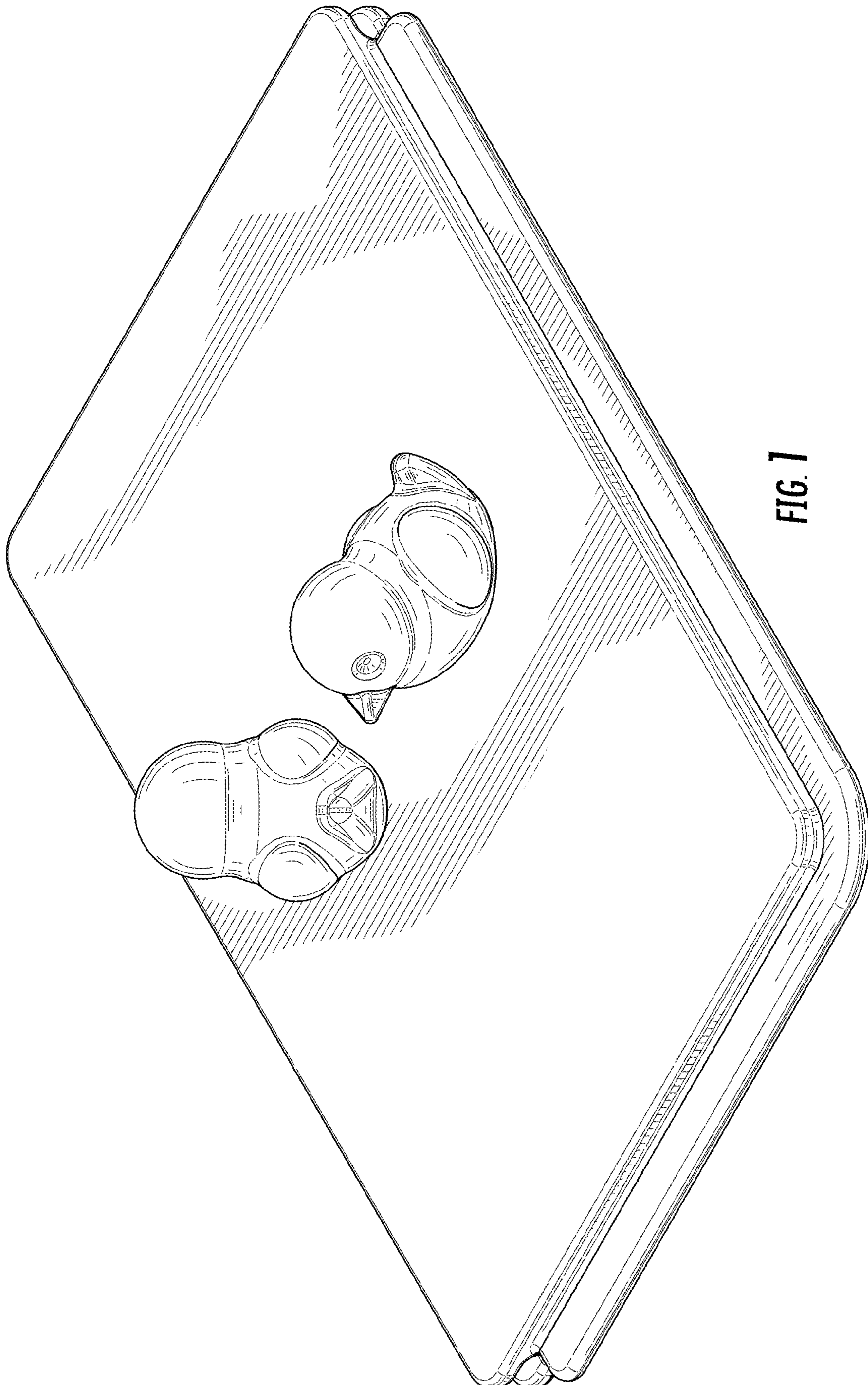

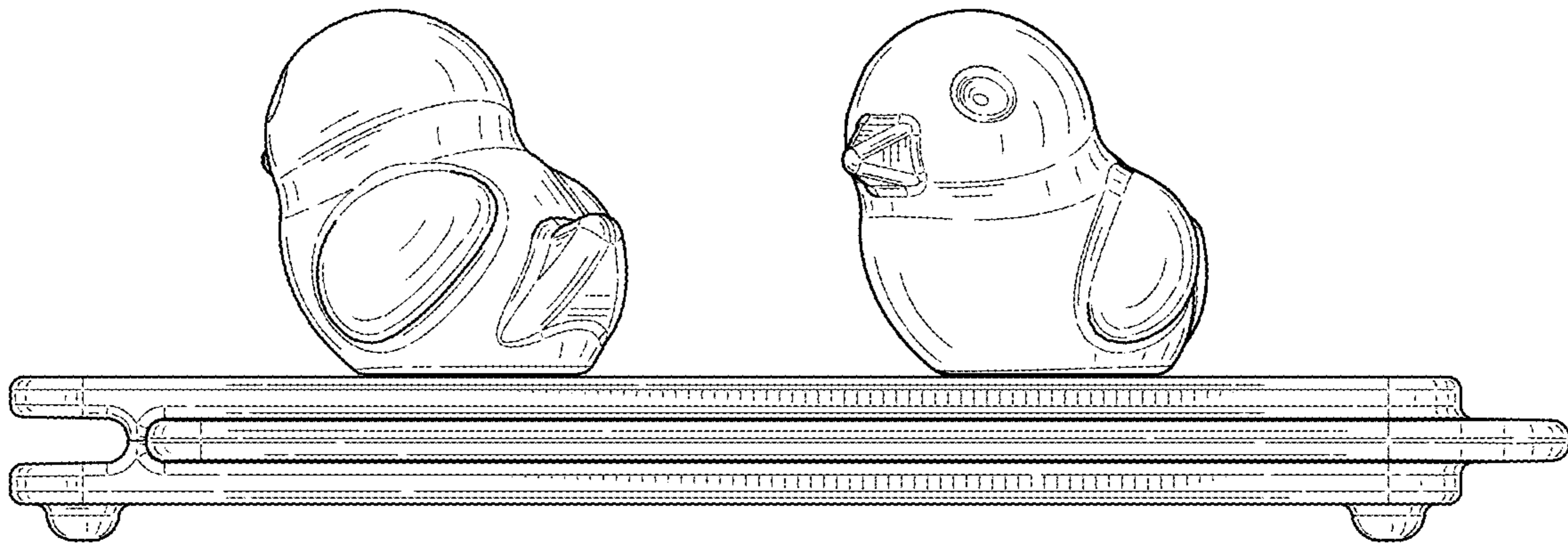

FIG. 2

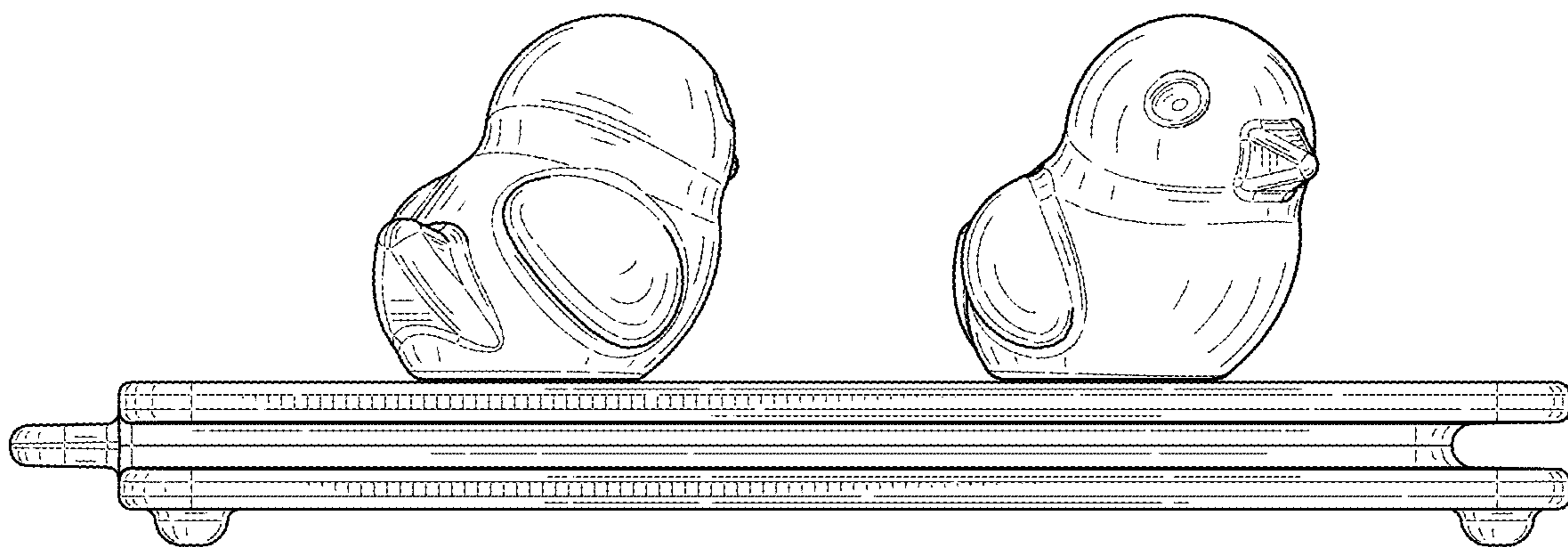

FIG. 3

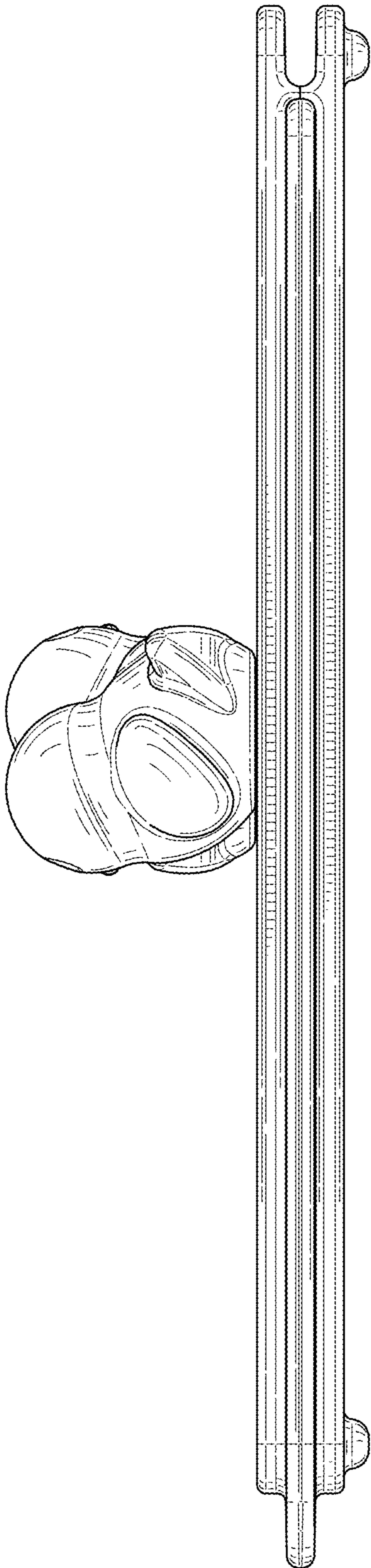

FIG. 4

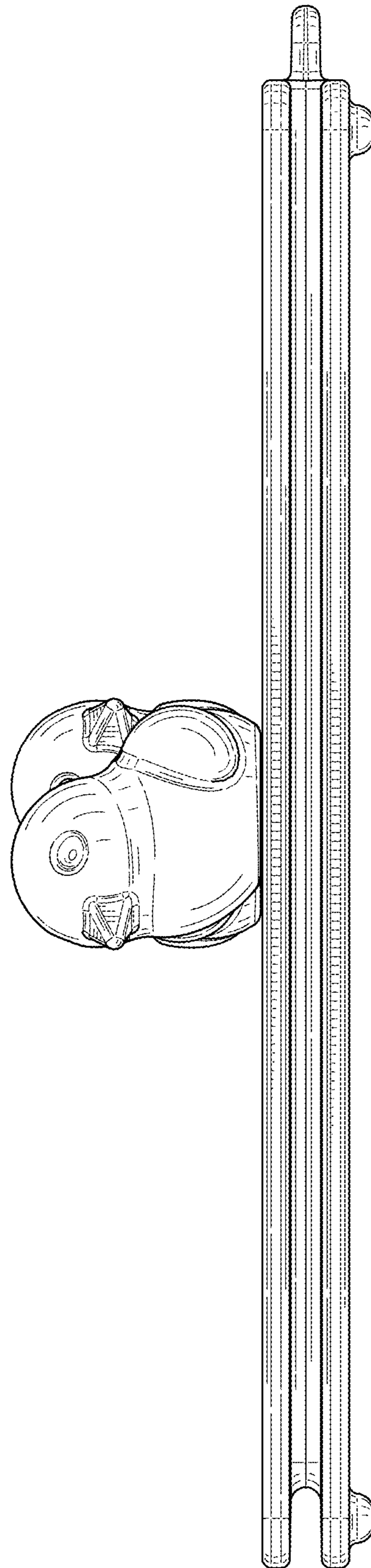

FIG. 5

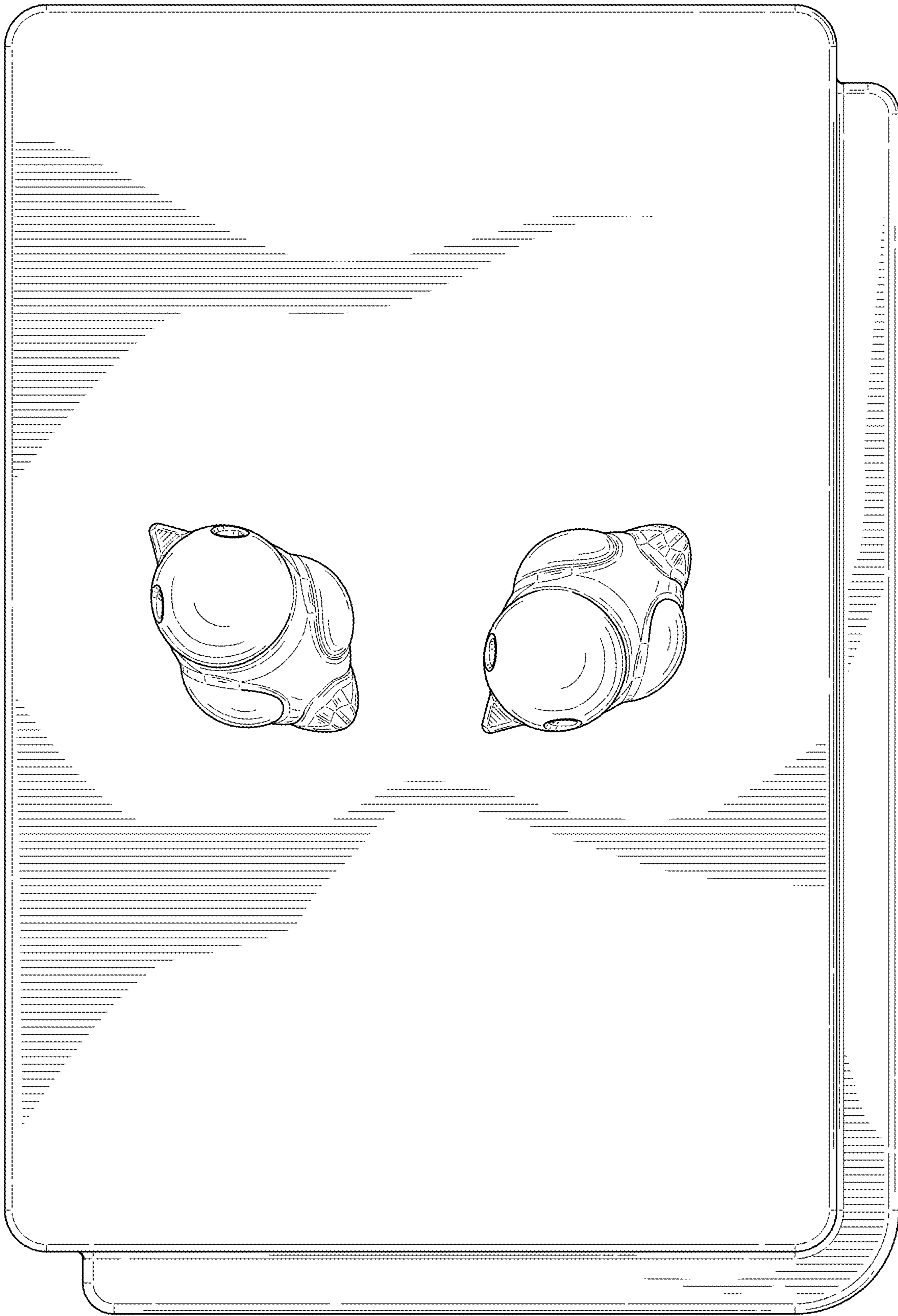

FIG. 6

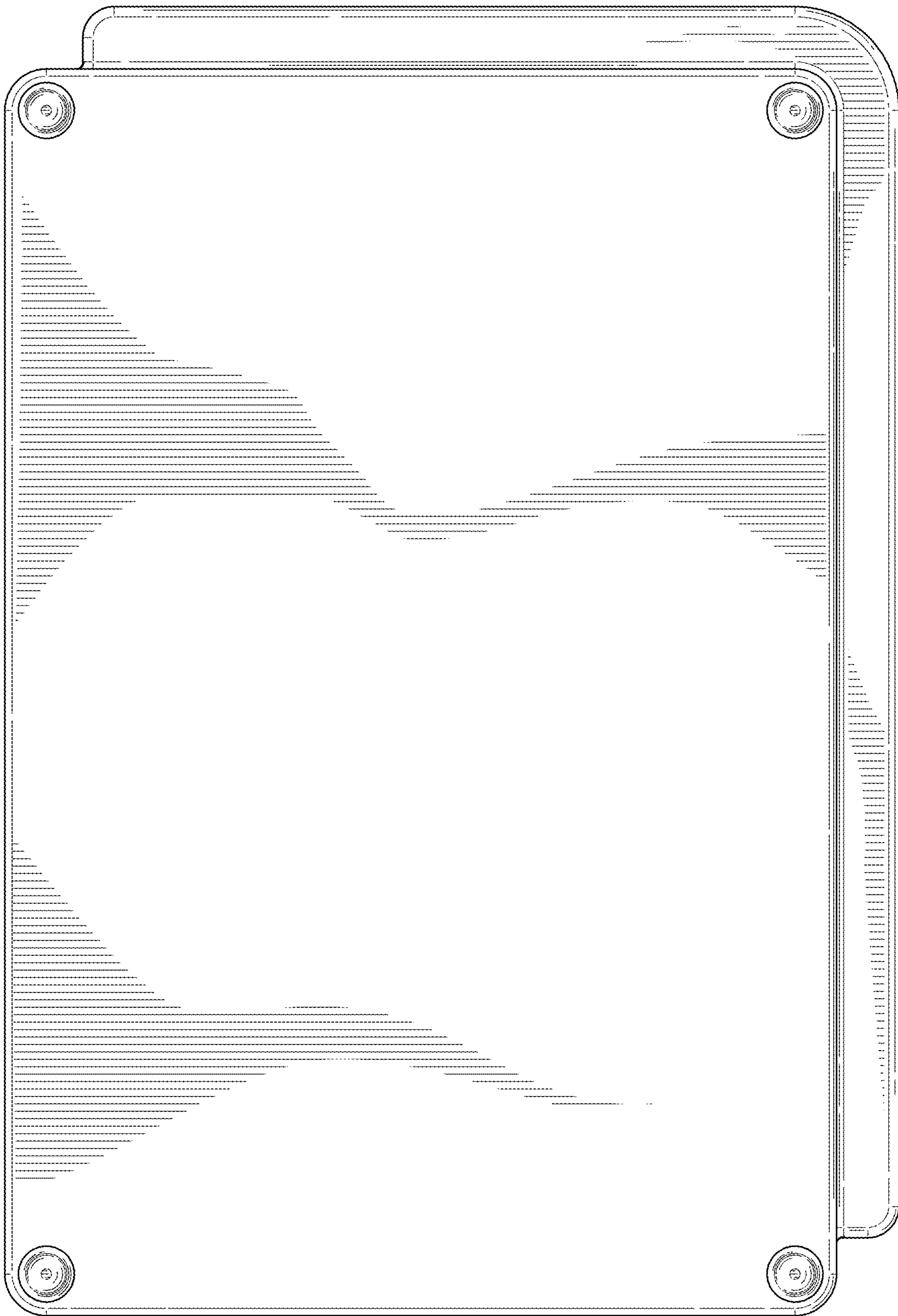

FIG. 7

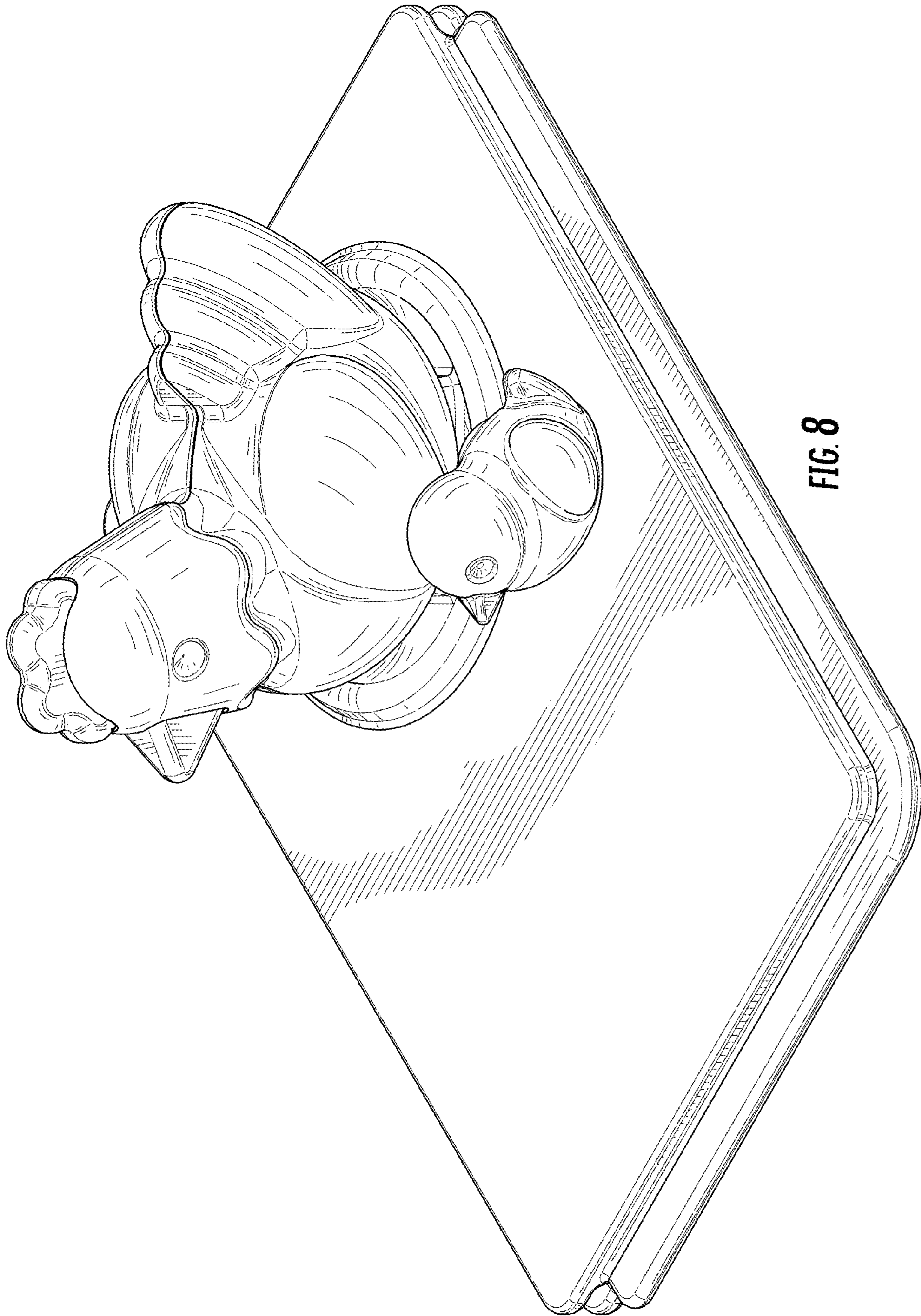

FIG. 8

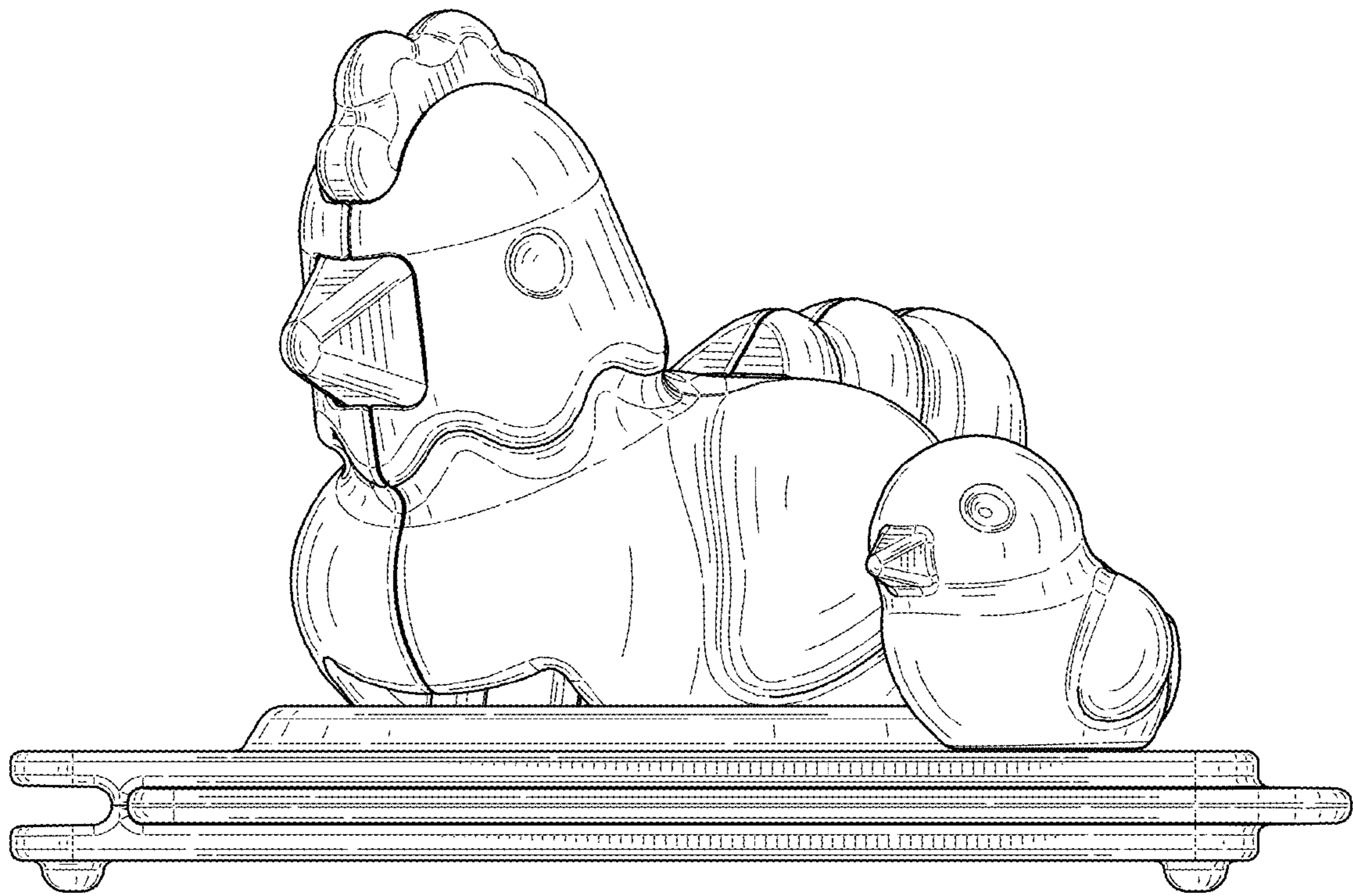

FIG. 9

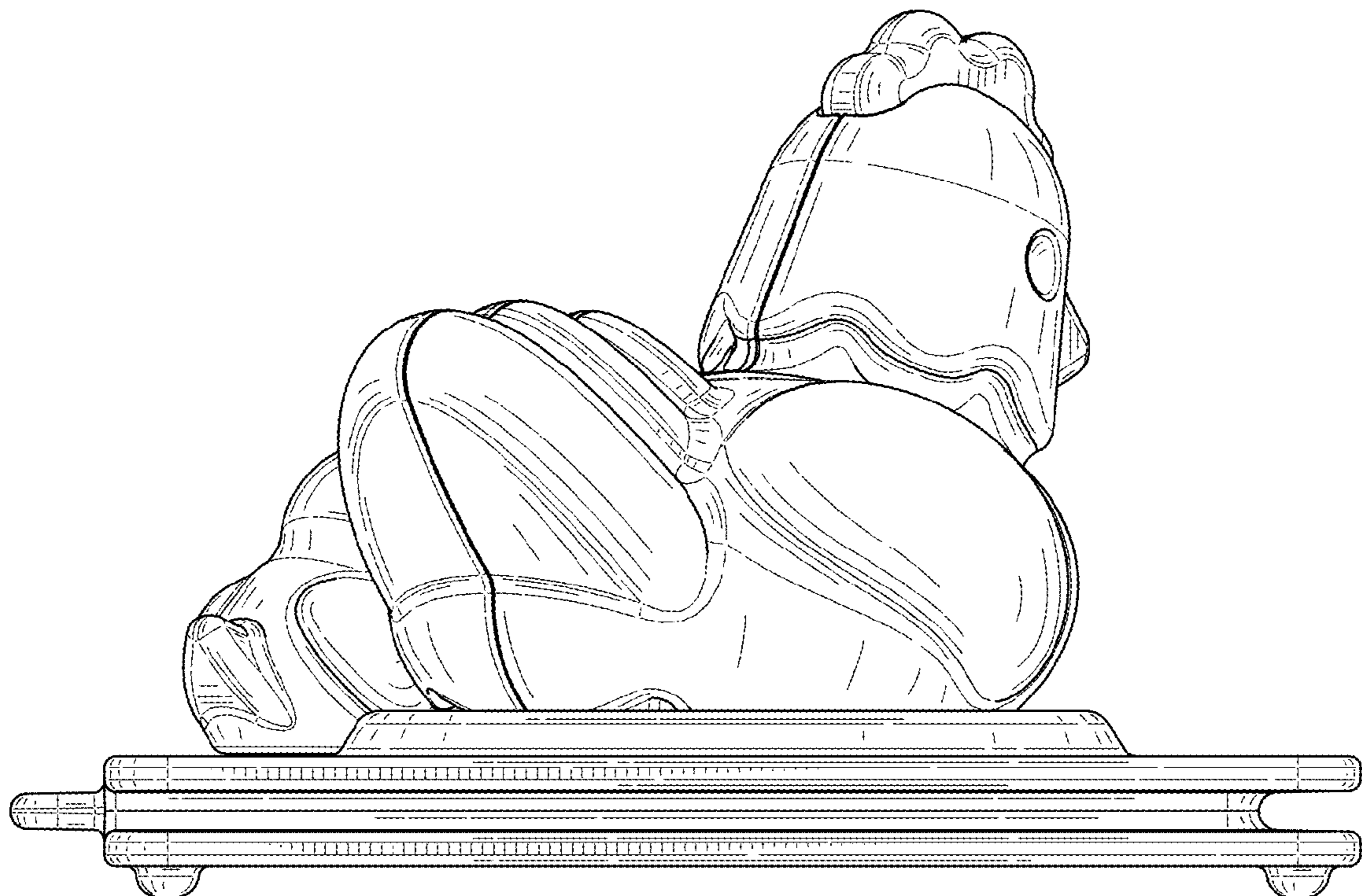

FIG. 10

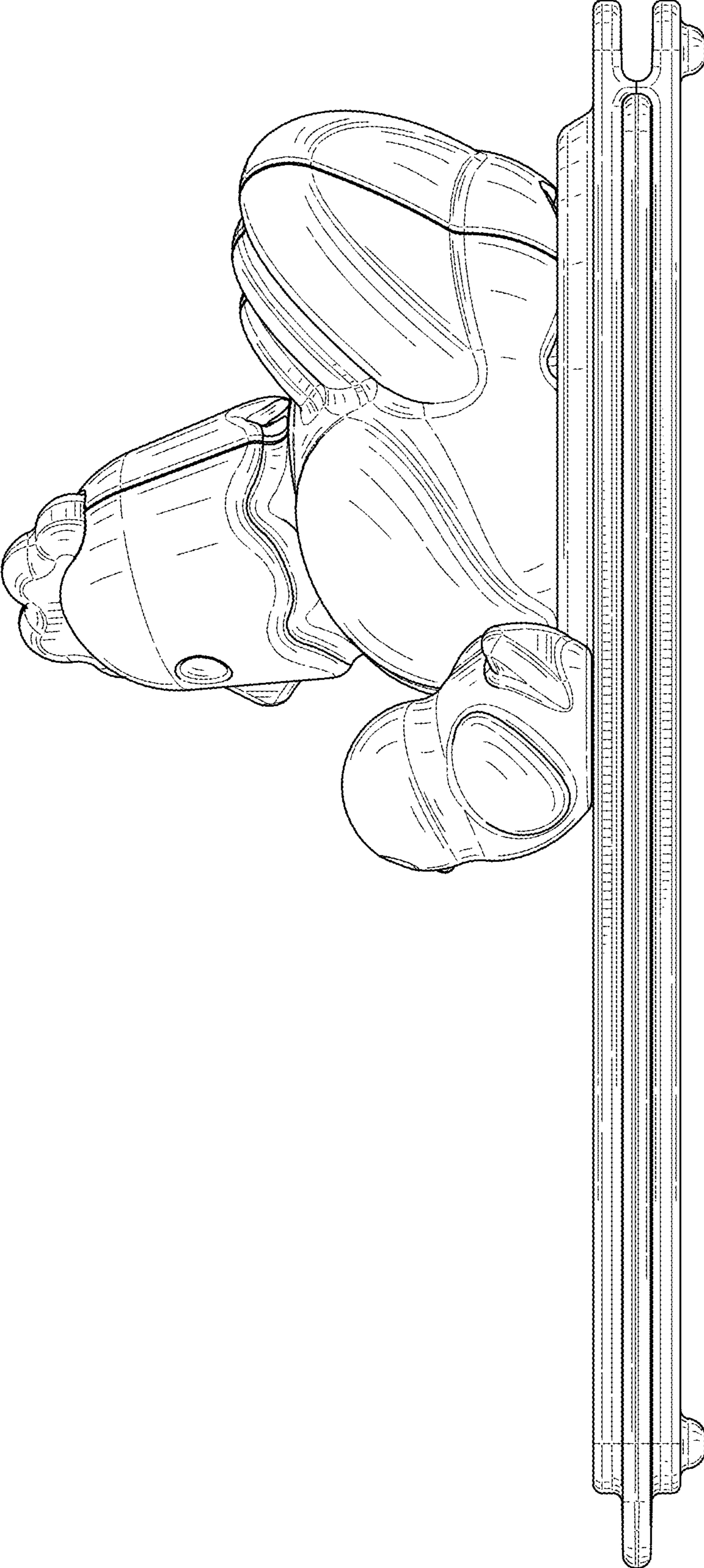

FIG. 11

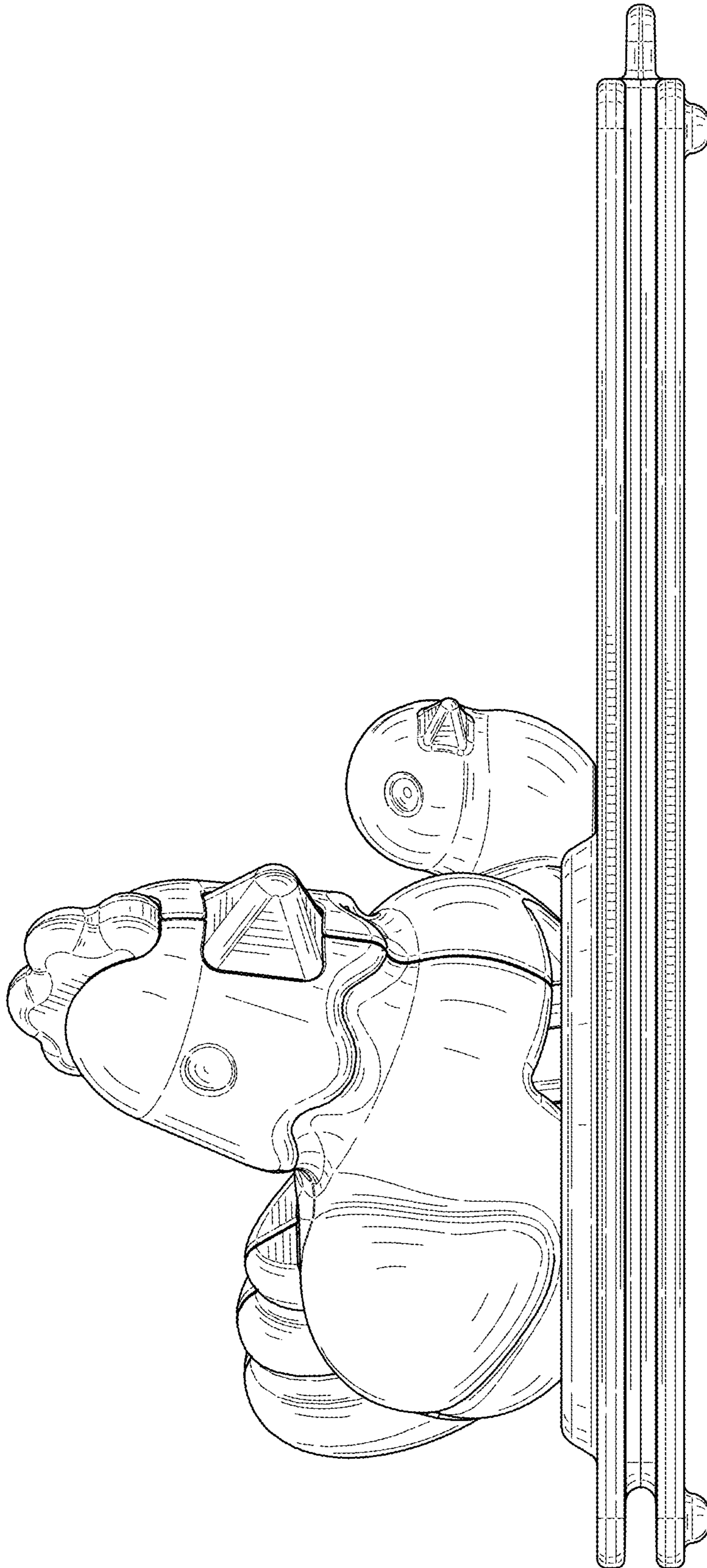

FIG. 12

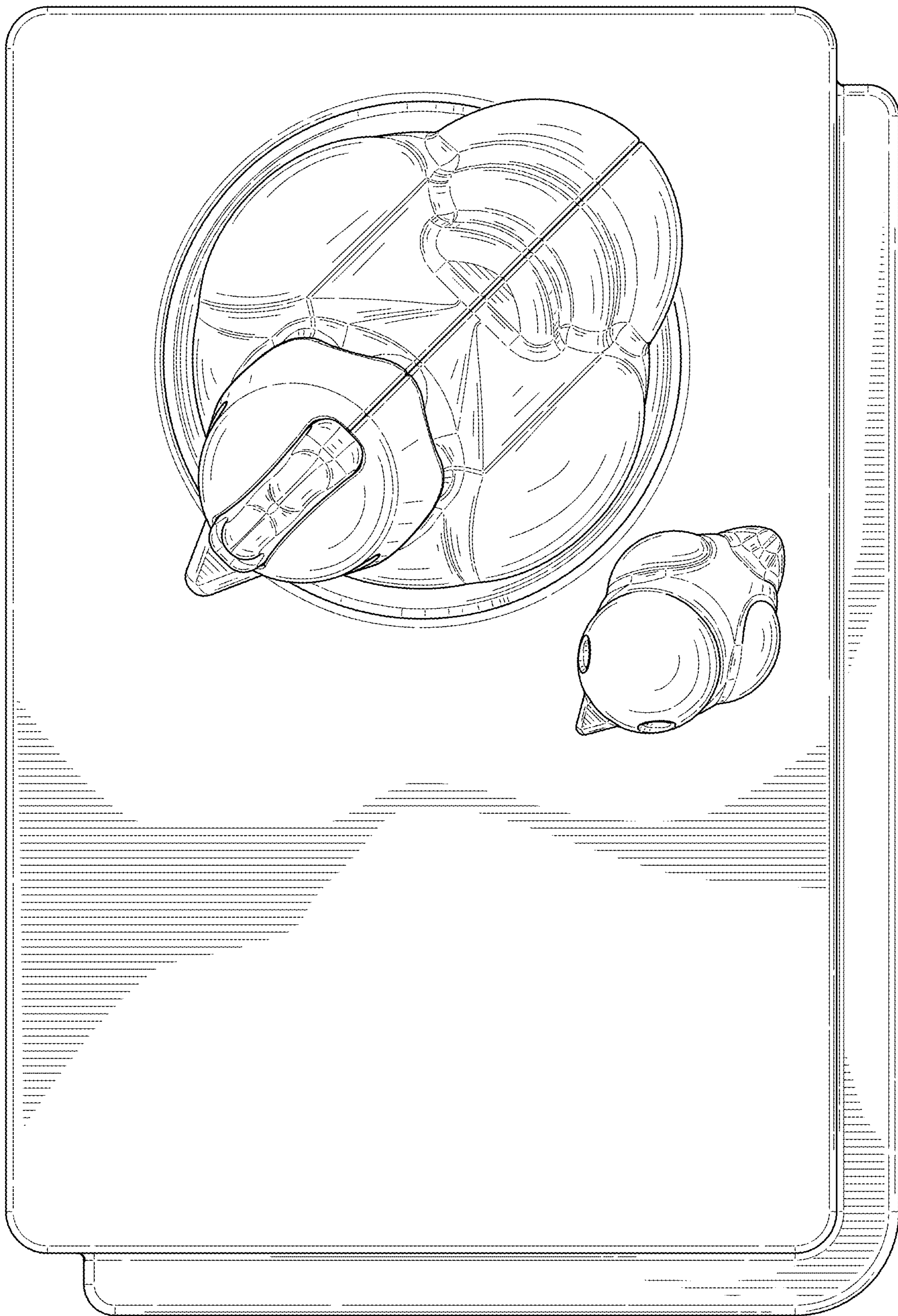

FIG. 13

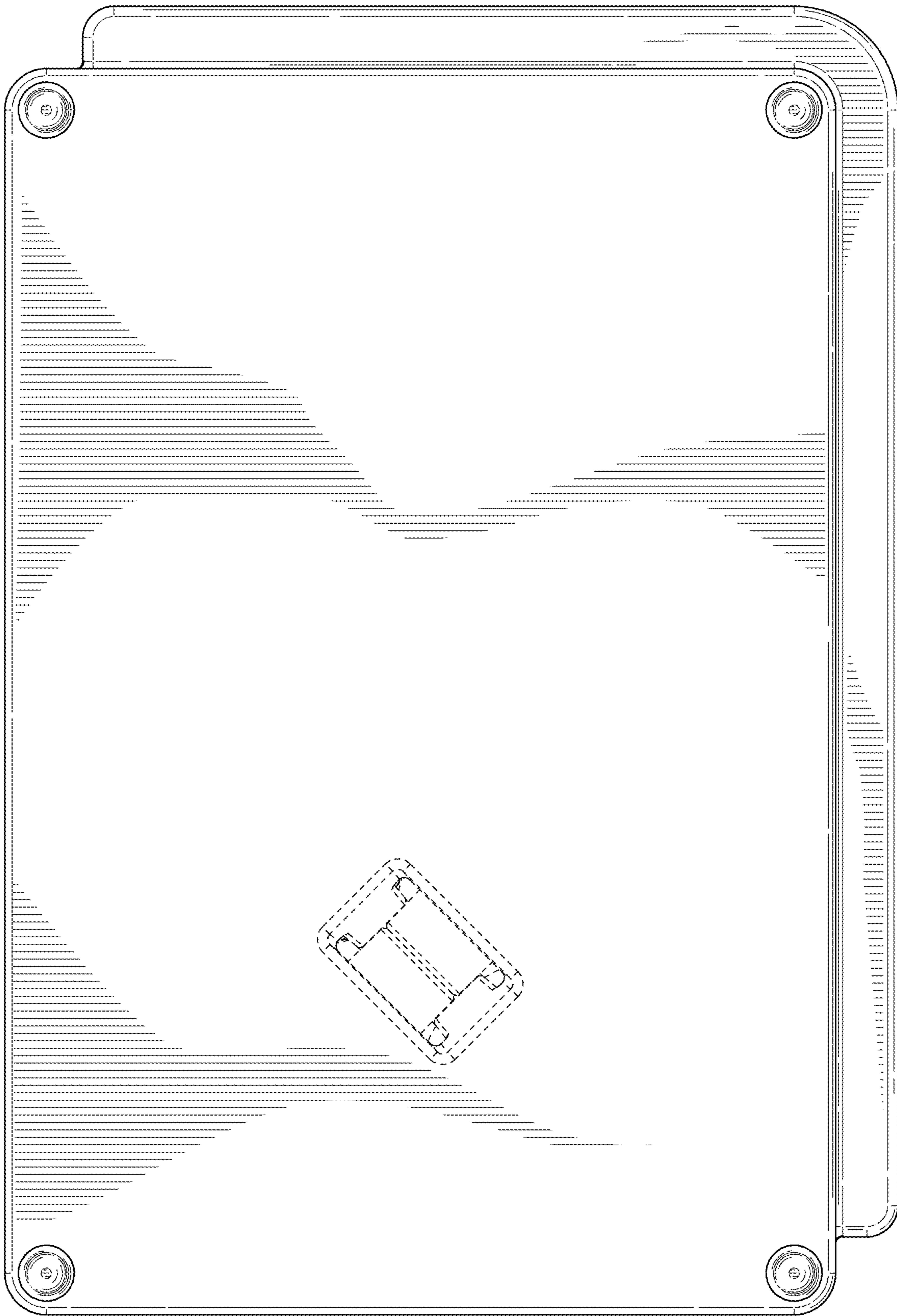

FIG. 14

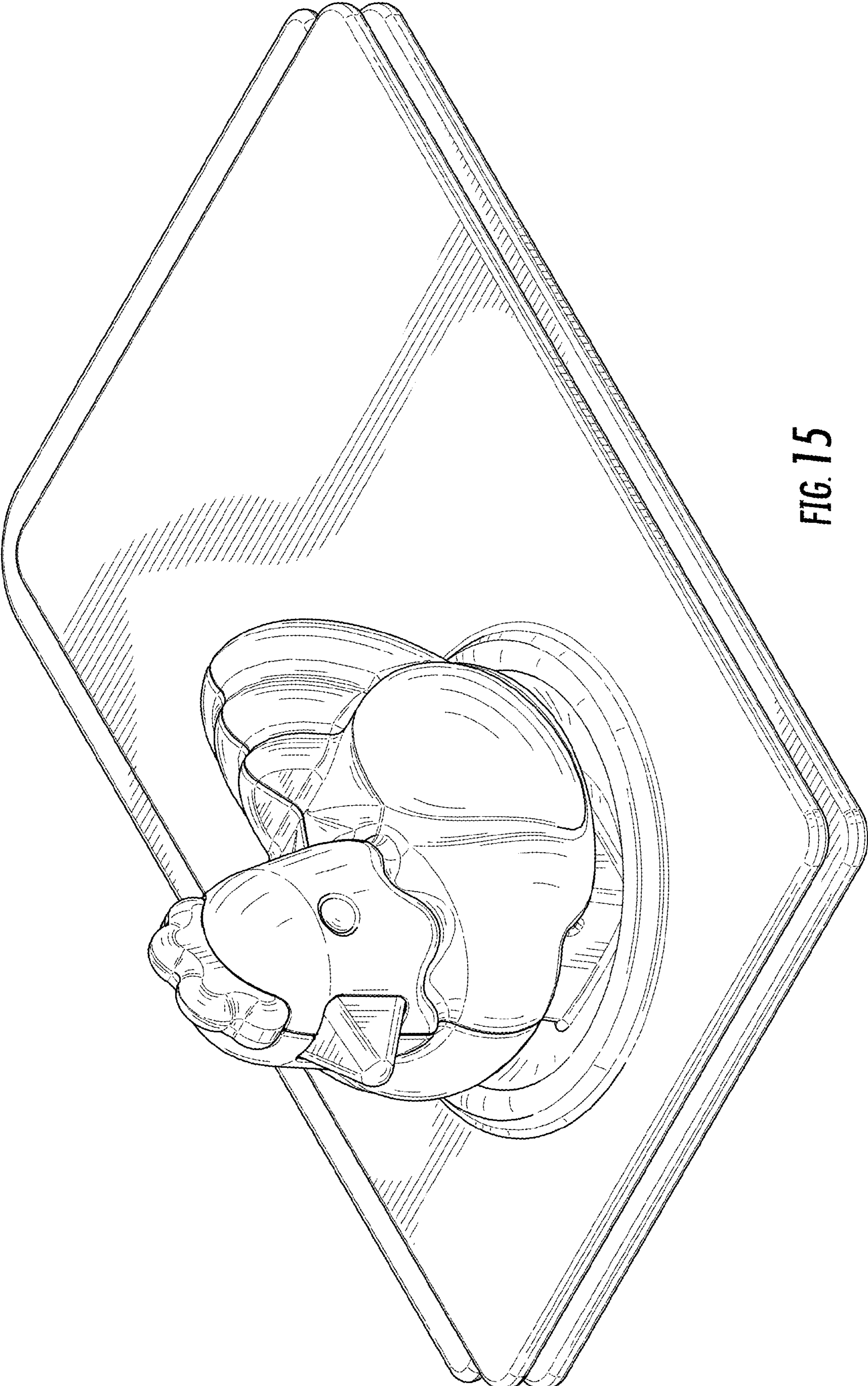

FIG. 15

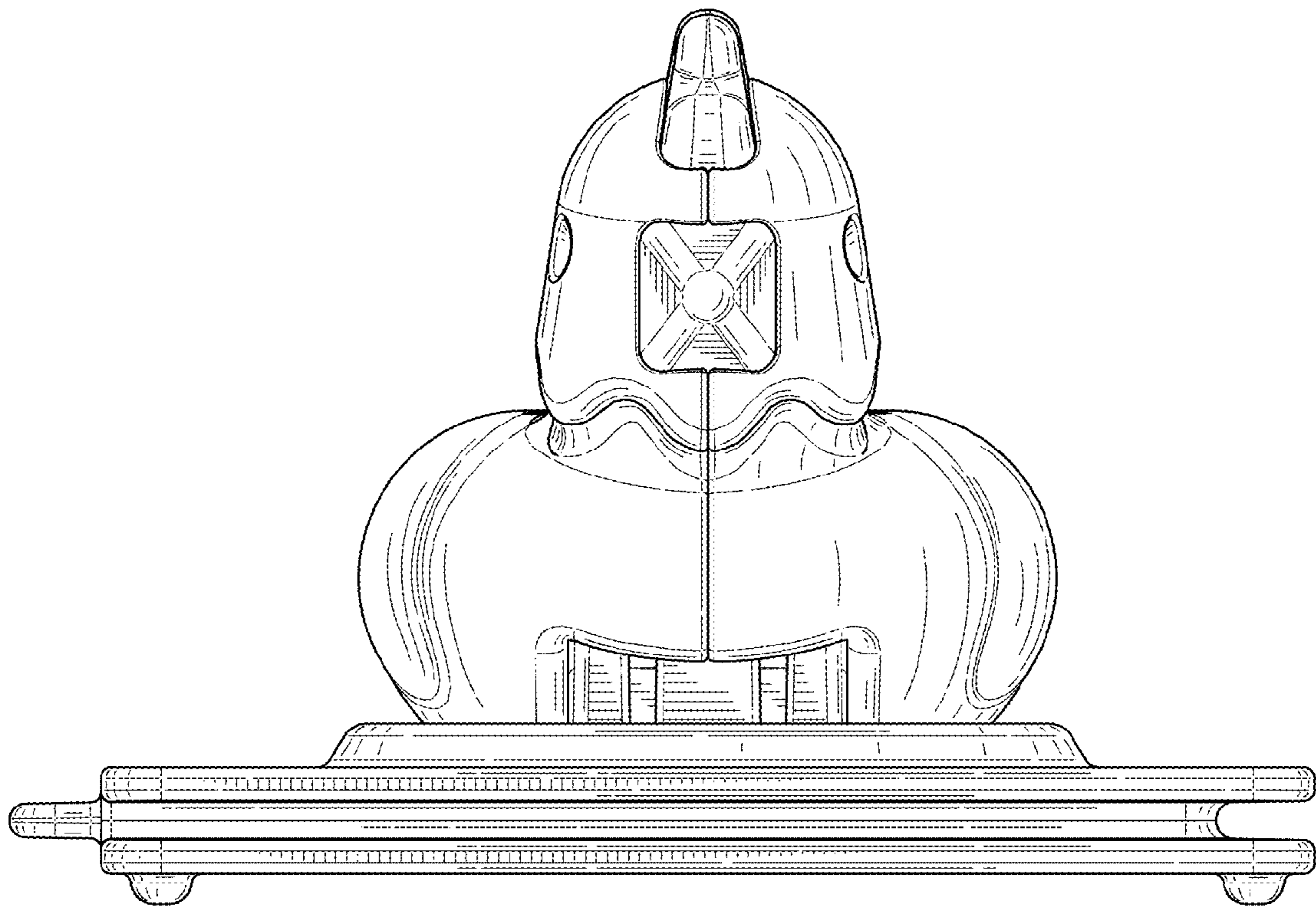

FIG. 16

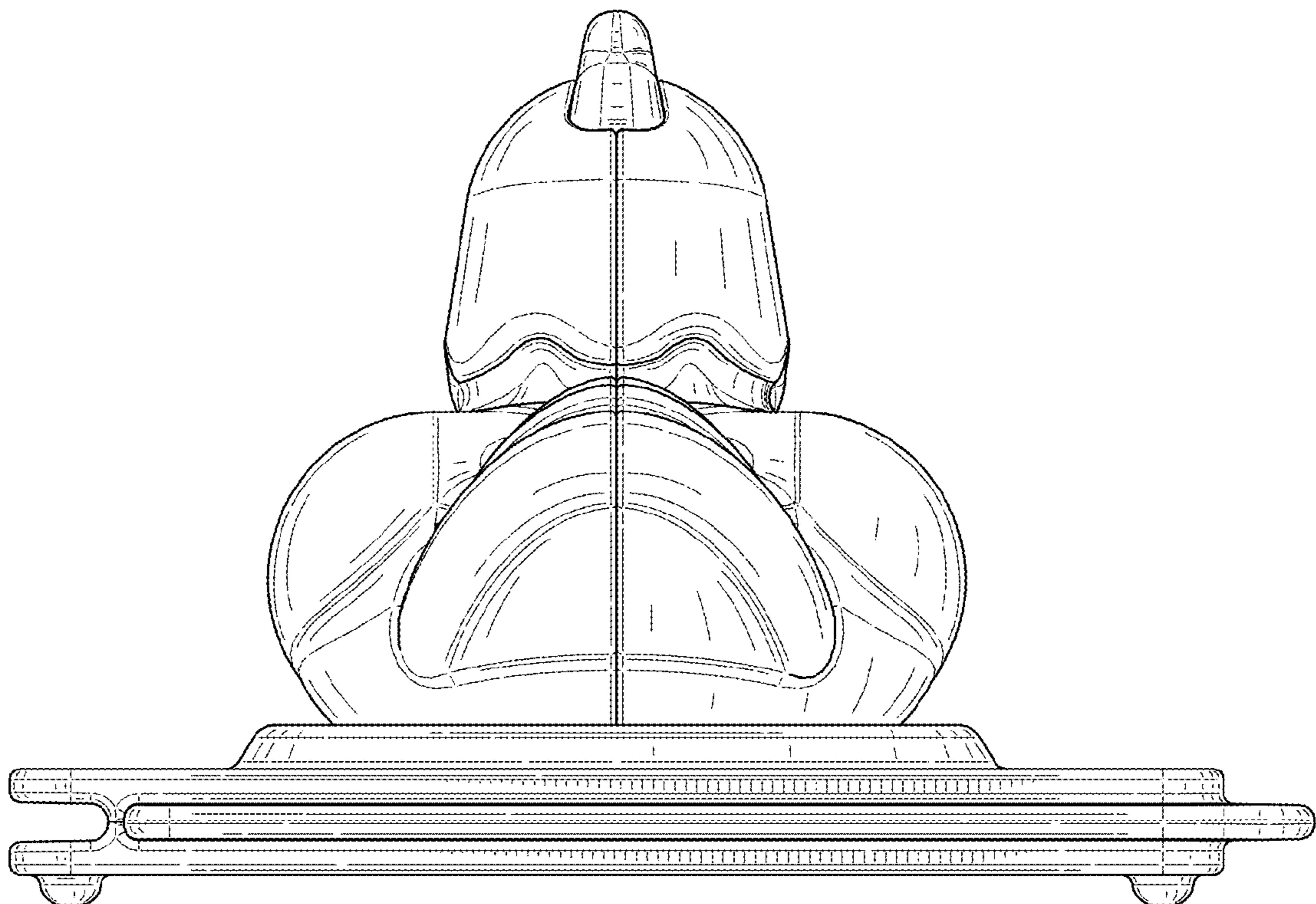

FIG. 17

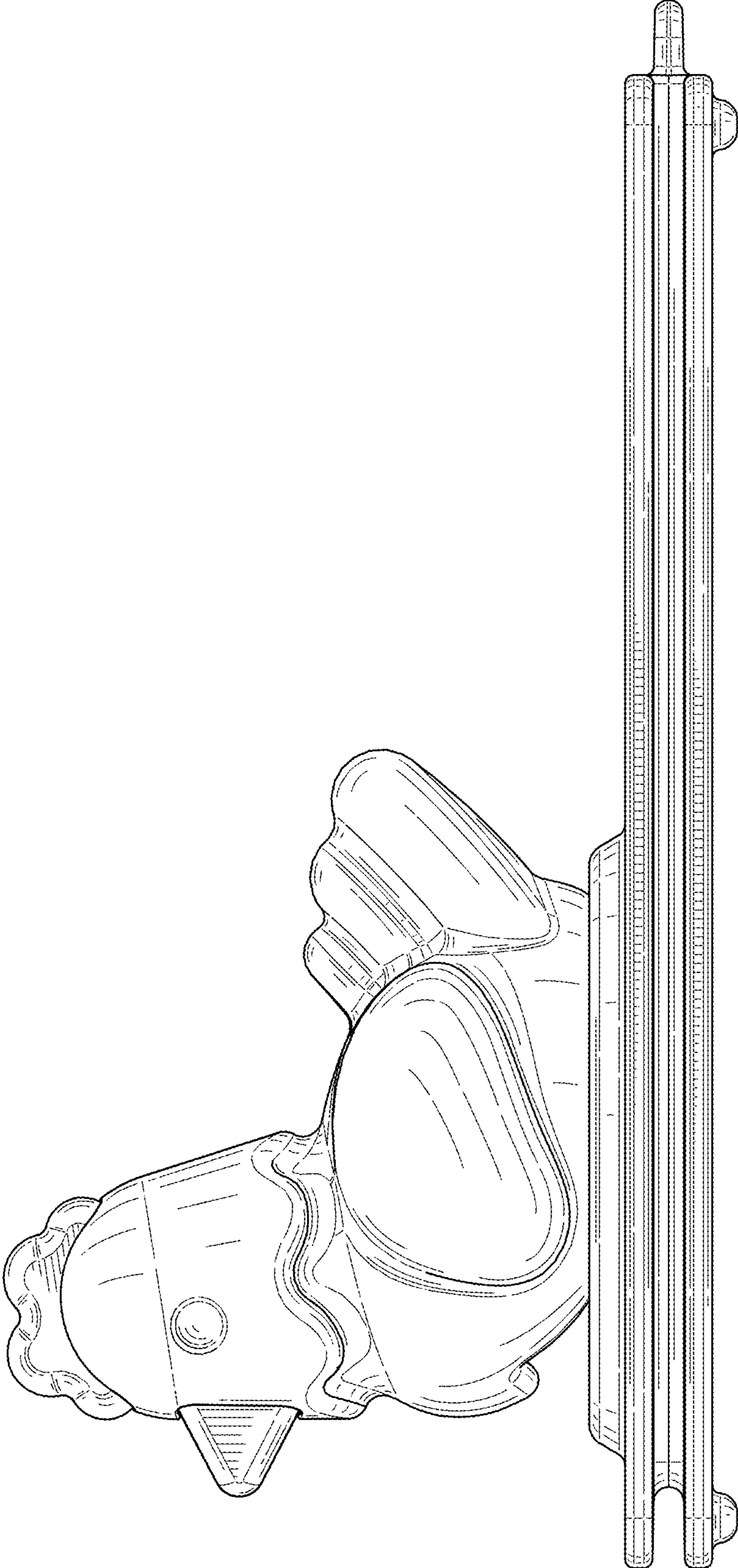

FIG. 18

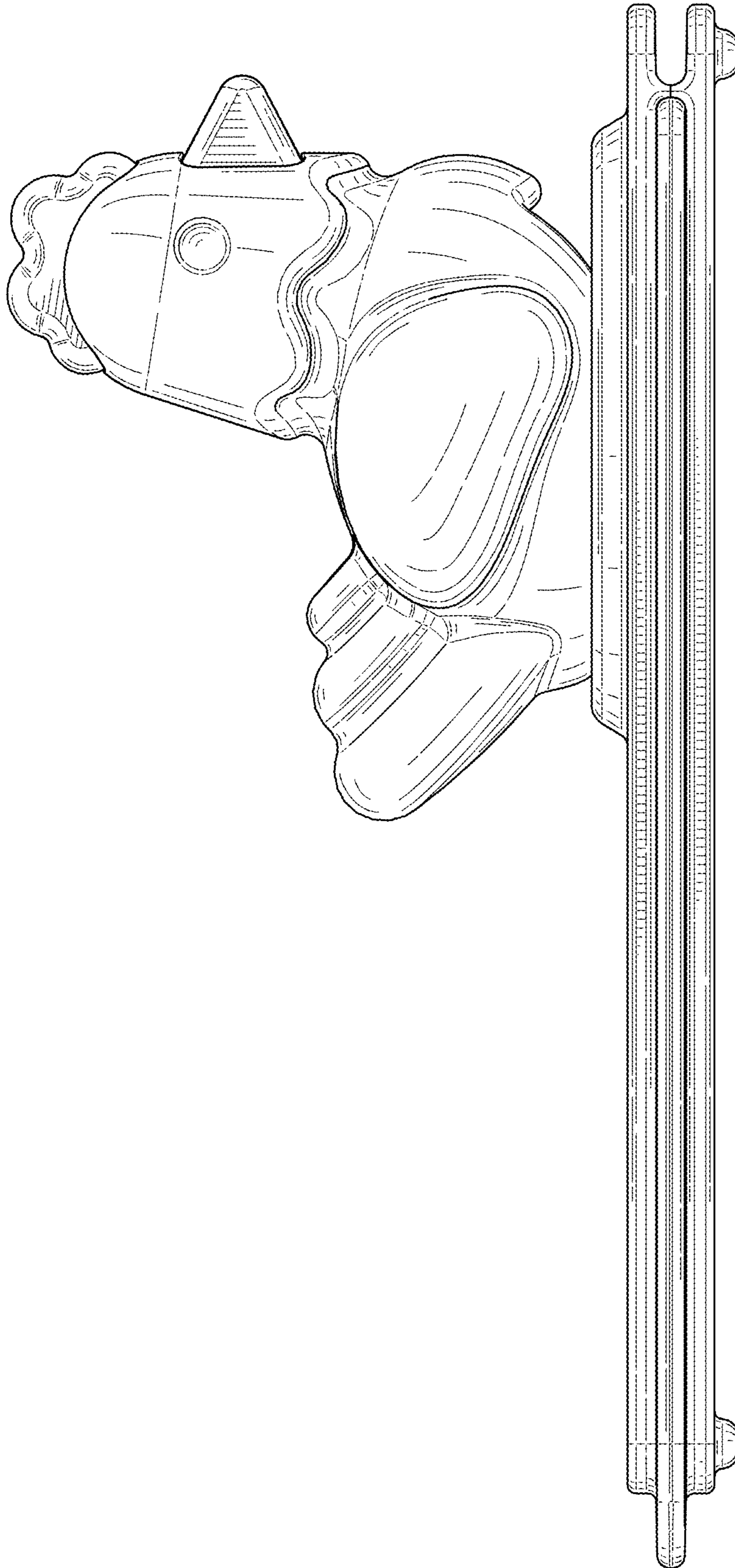

FIG. 19

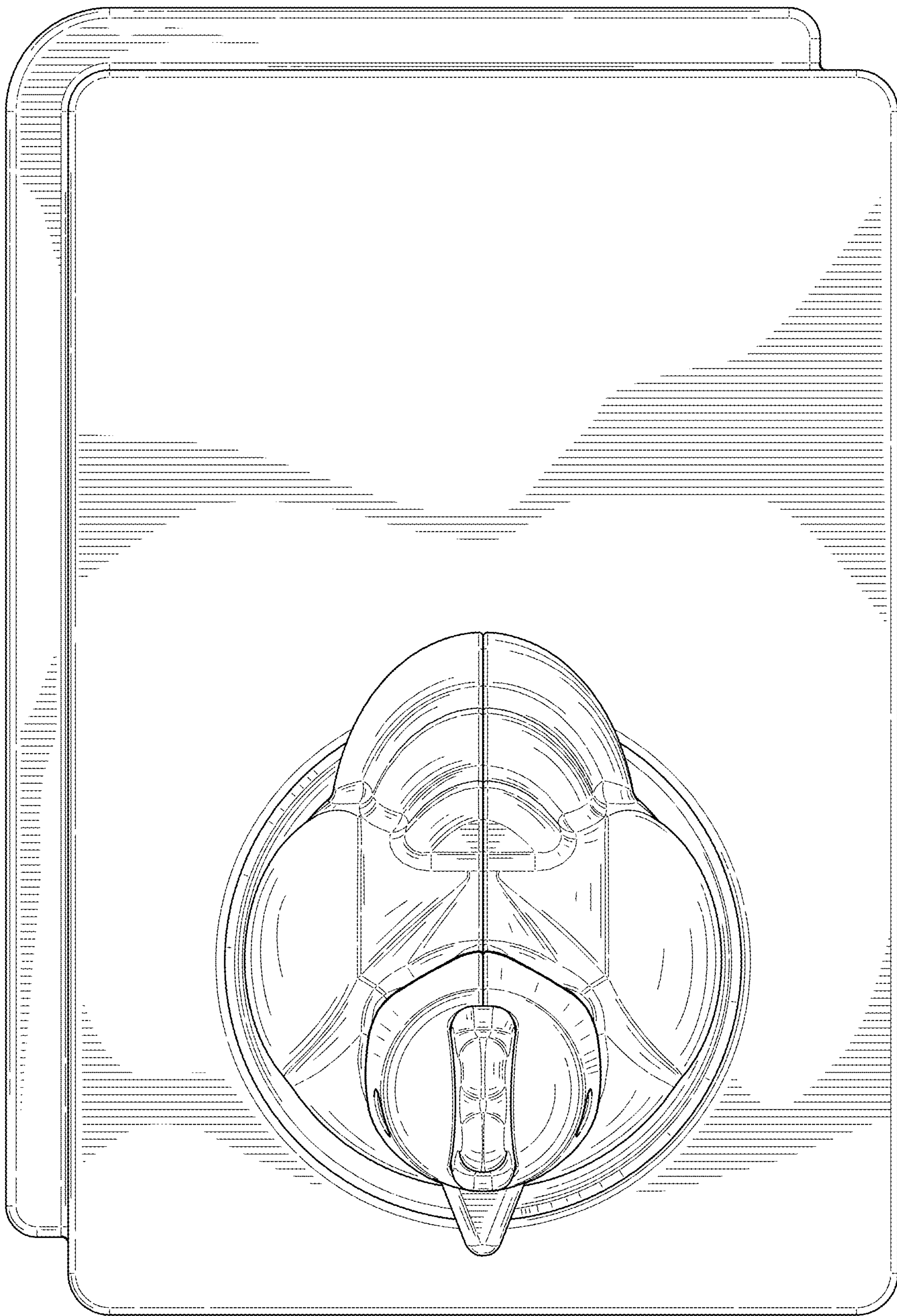

FIG. 20

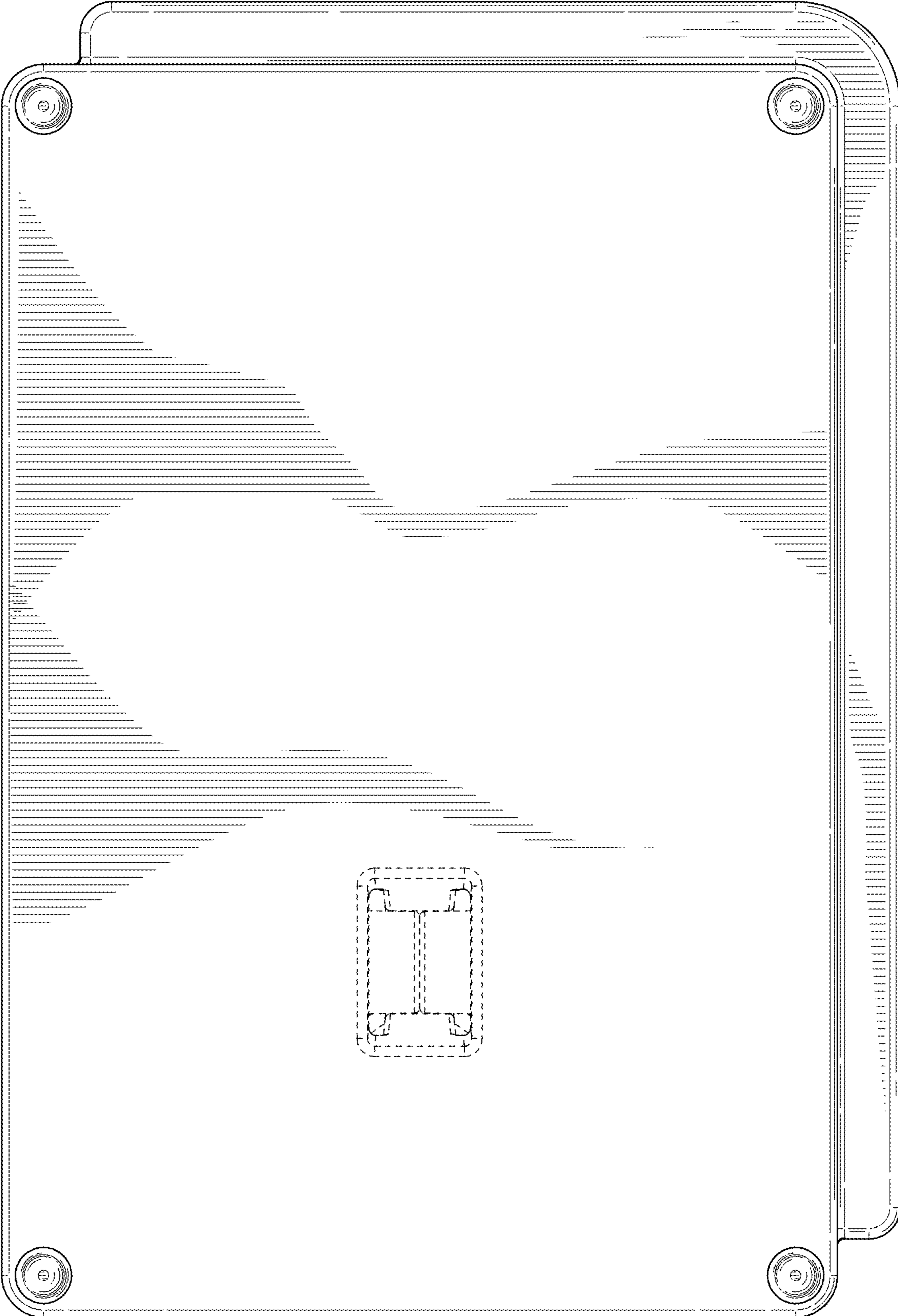

FIG. 21

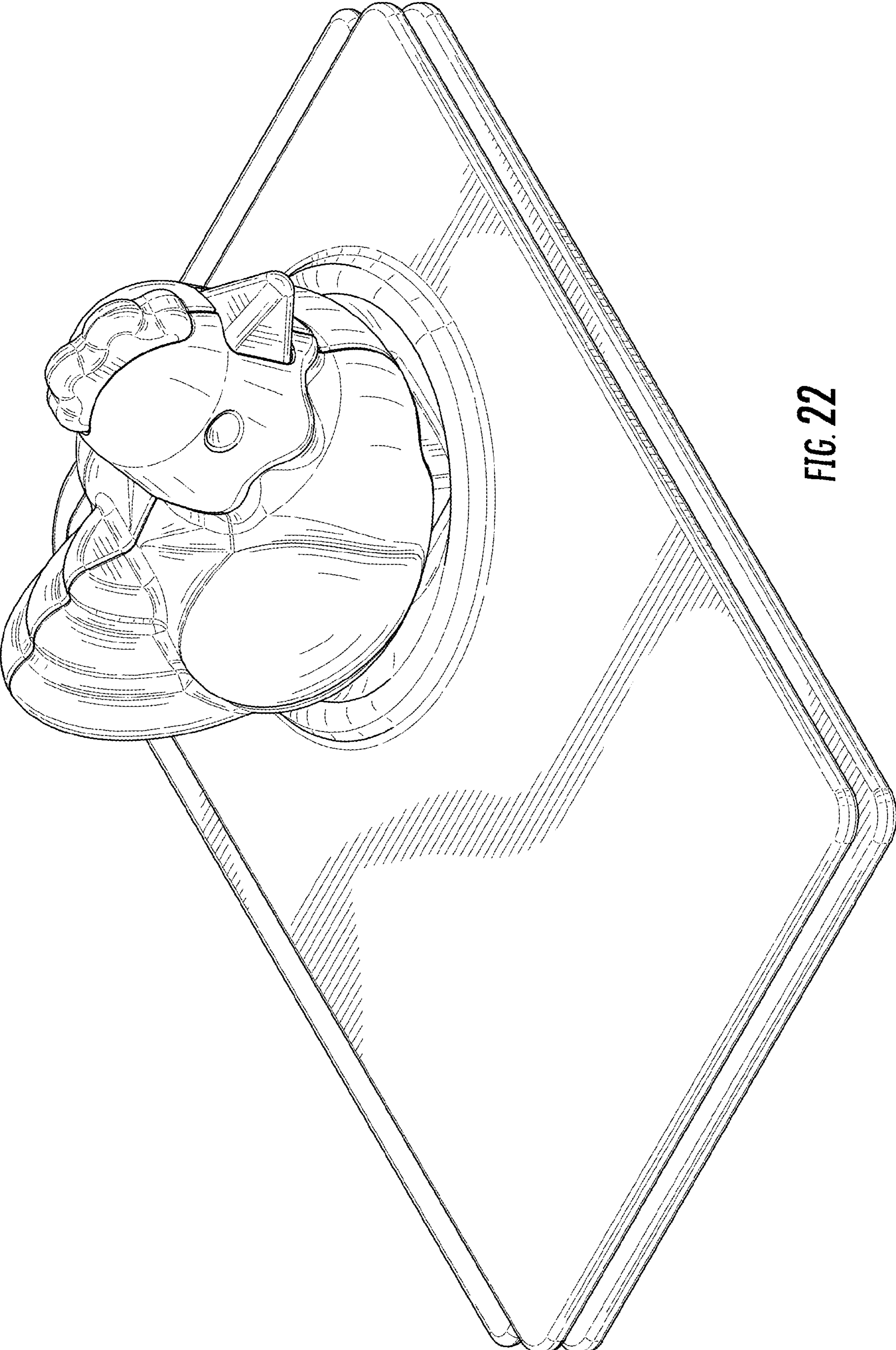

FIG. 22

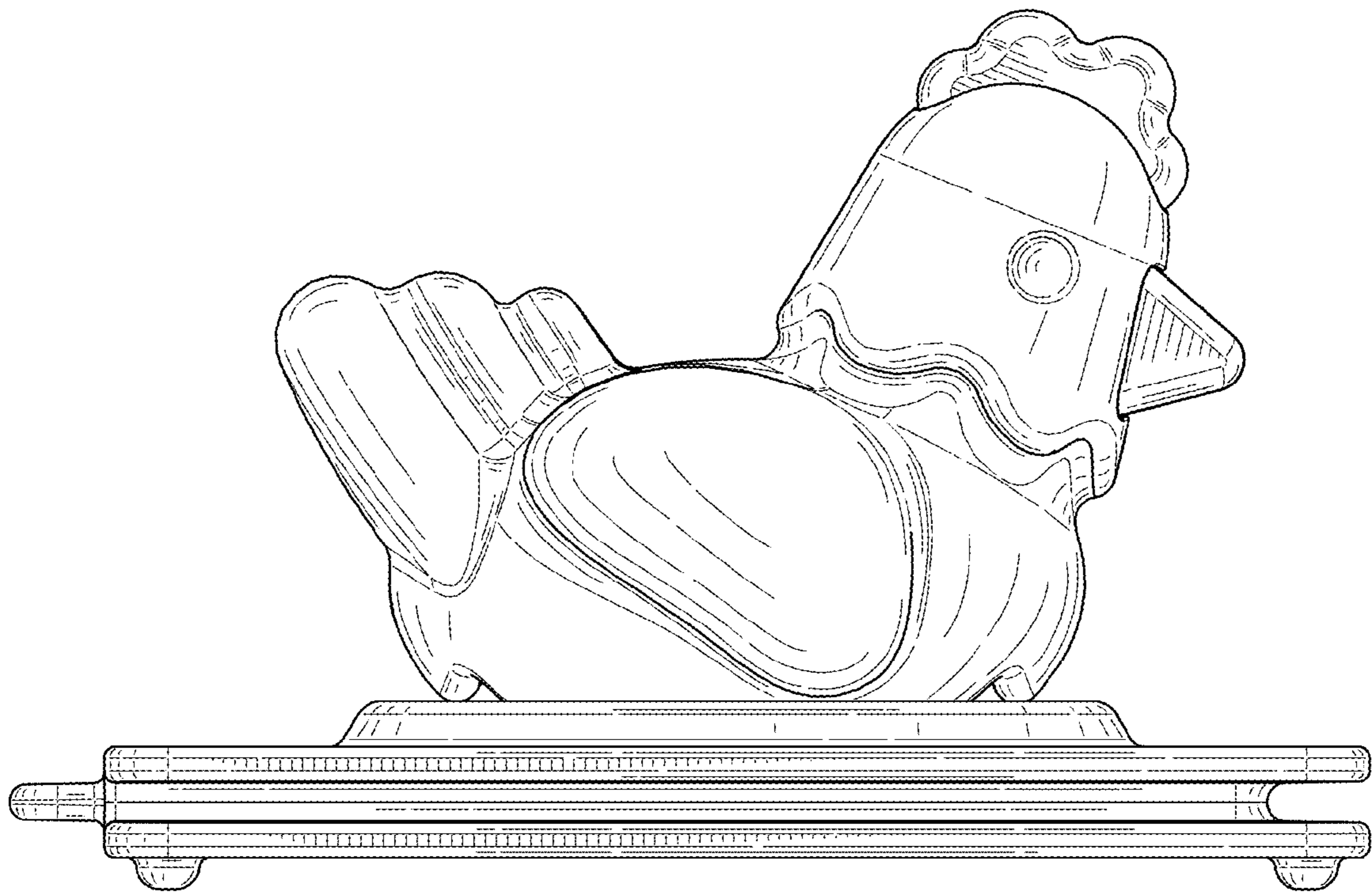

FIG. 23

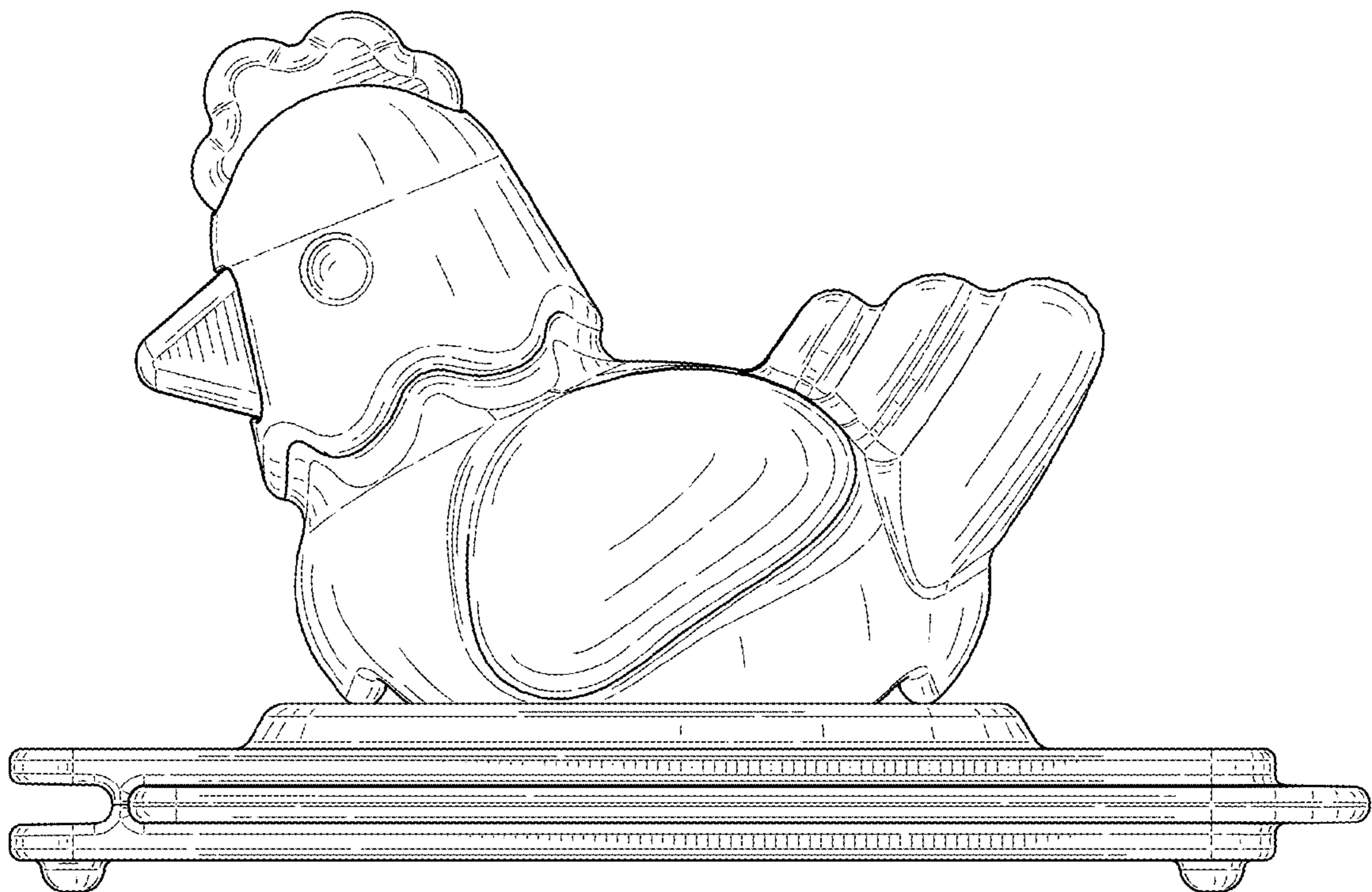

FIG. 24

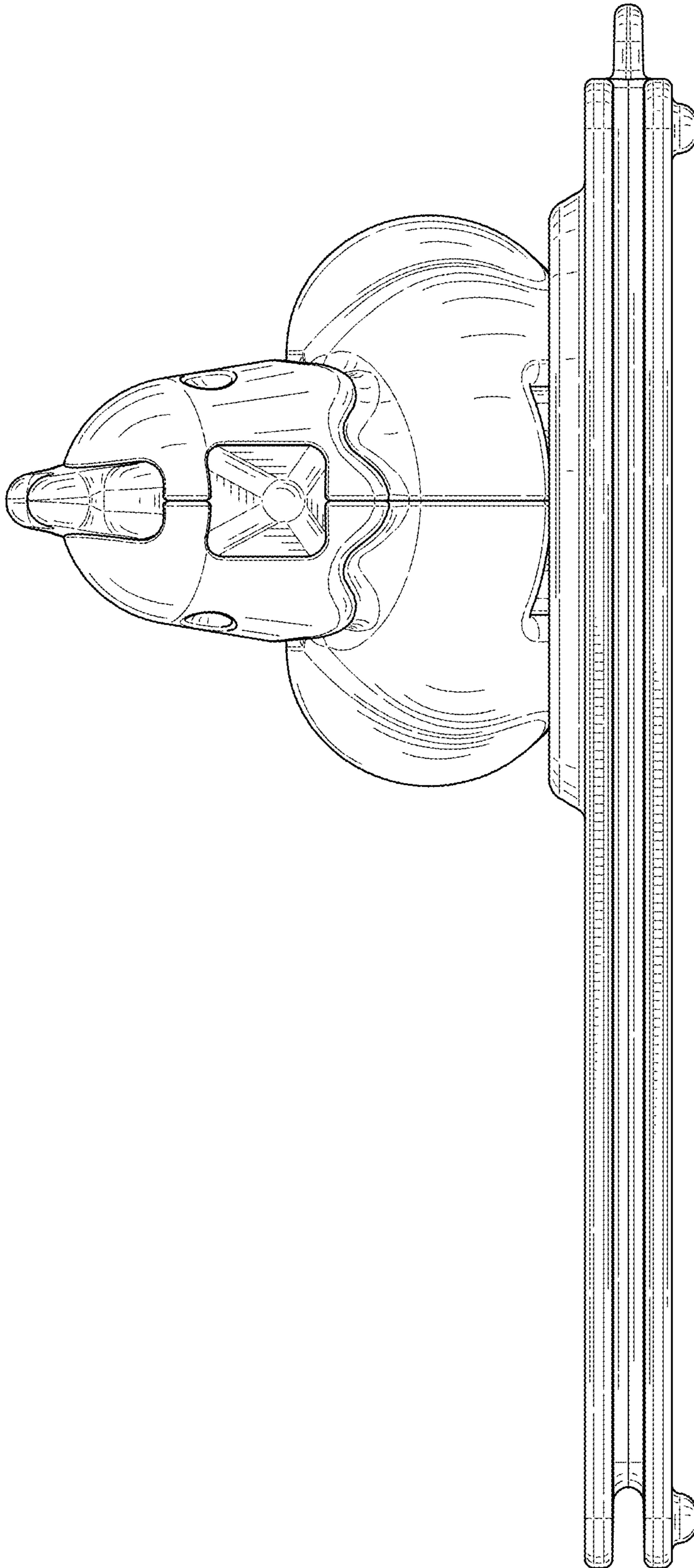

FIG. 25

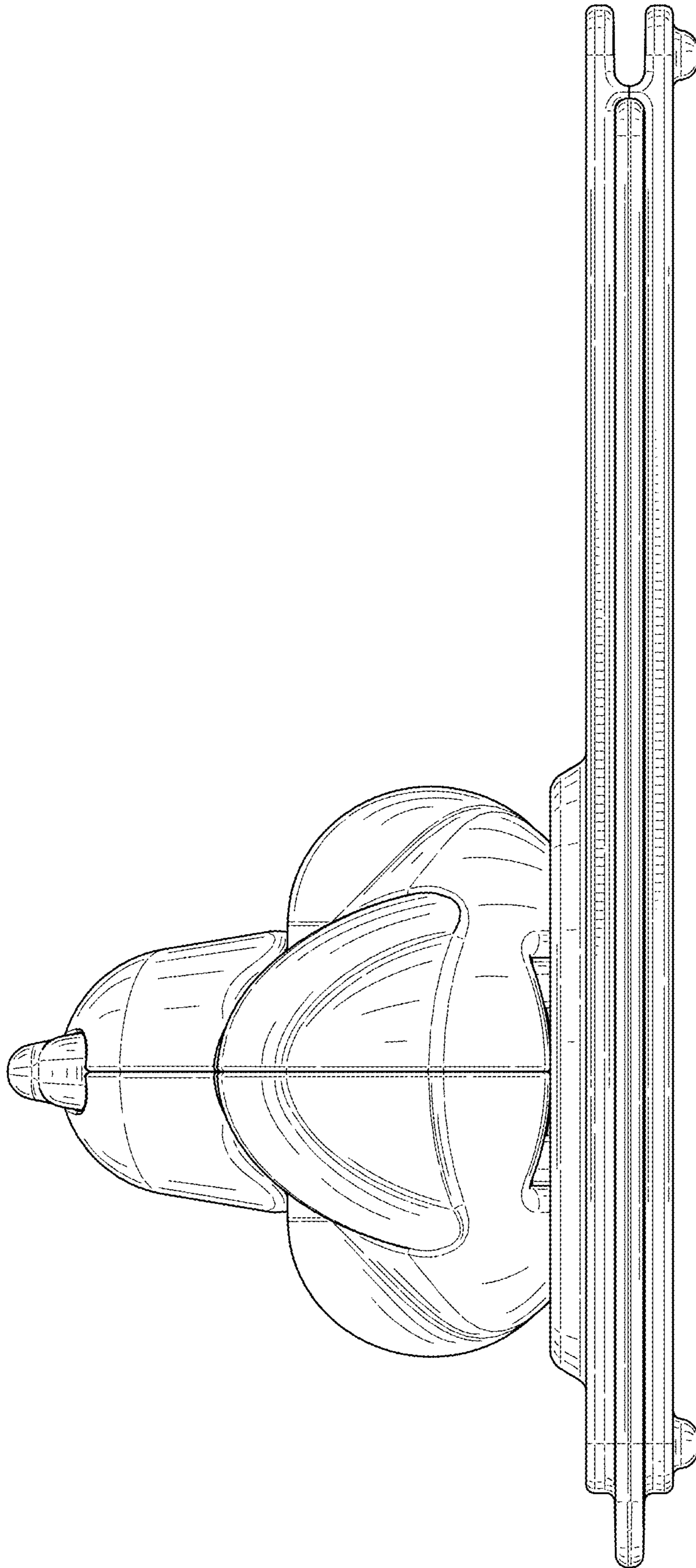

FIG. 26

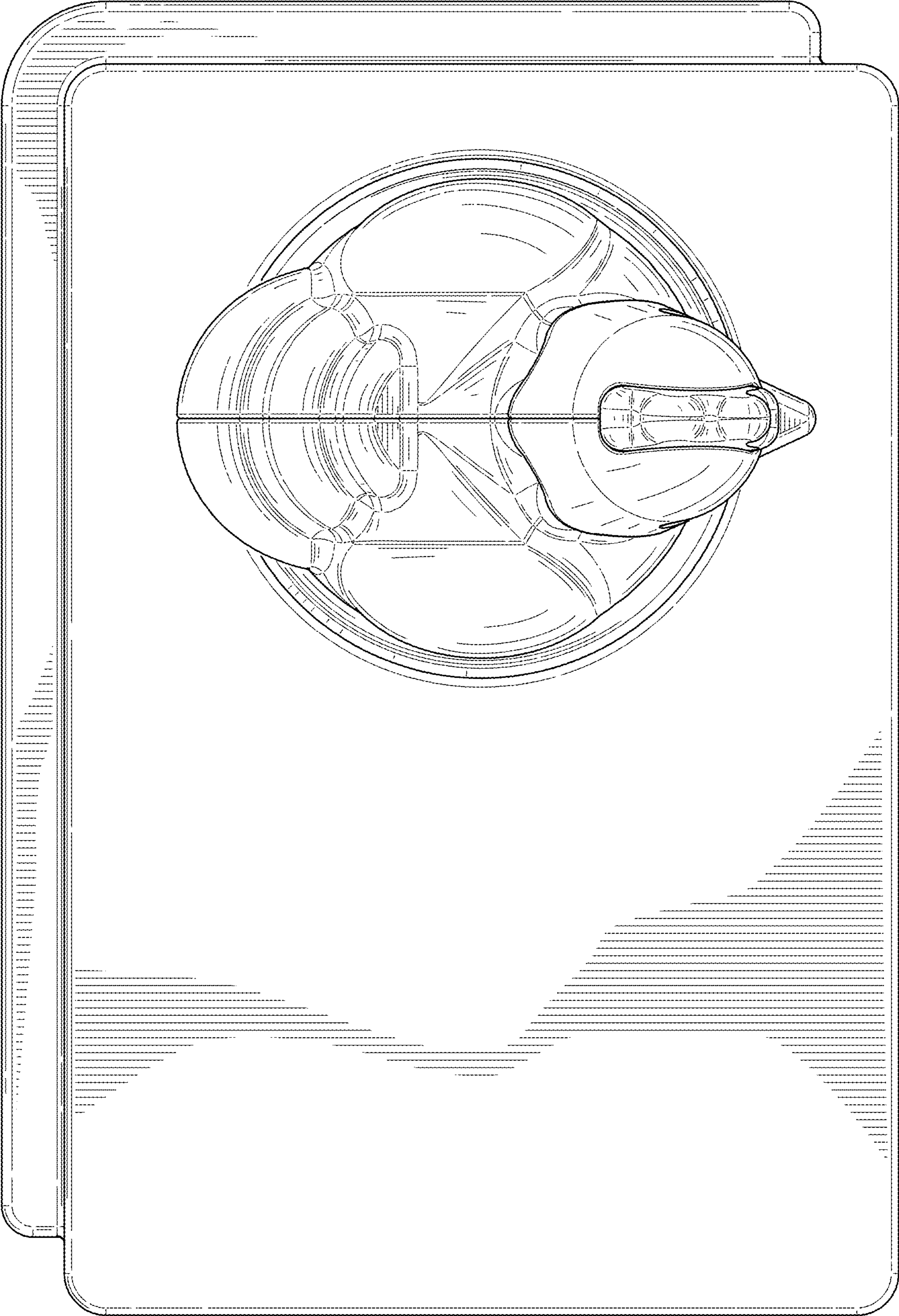

FIG. 27

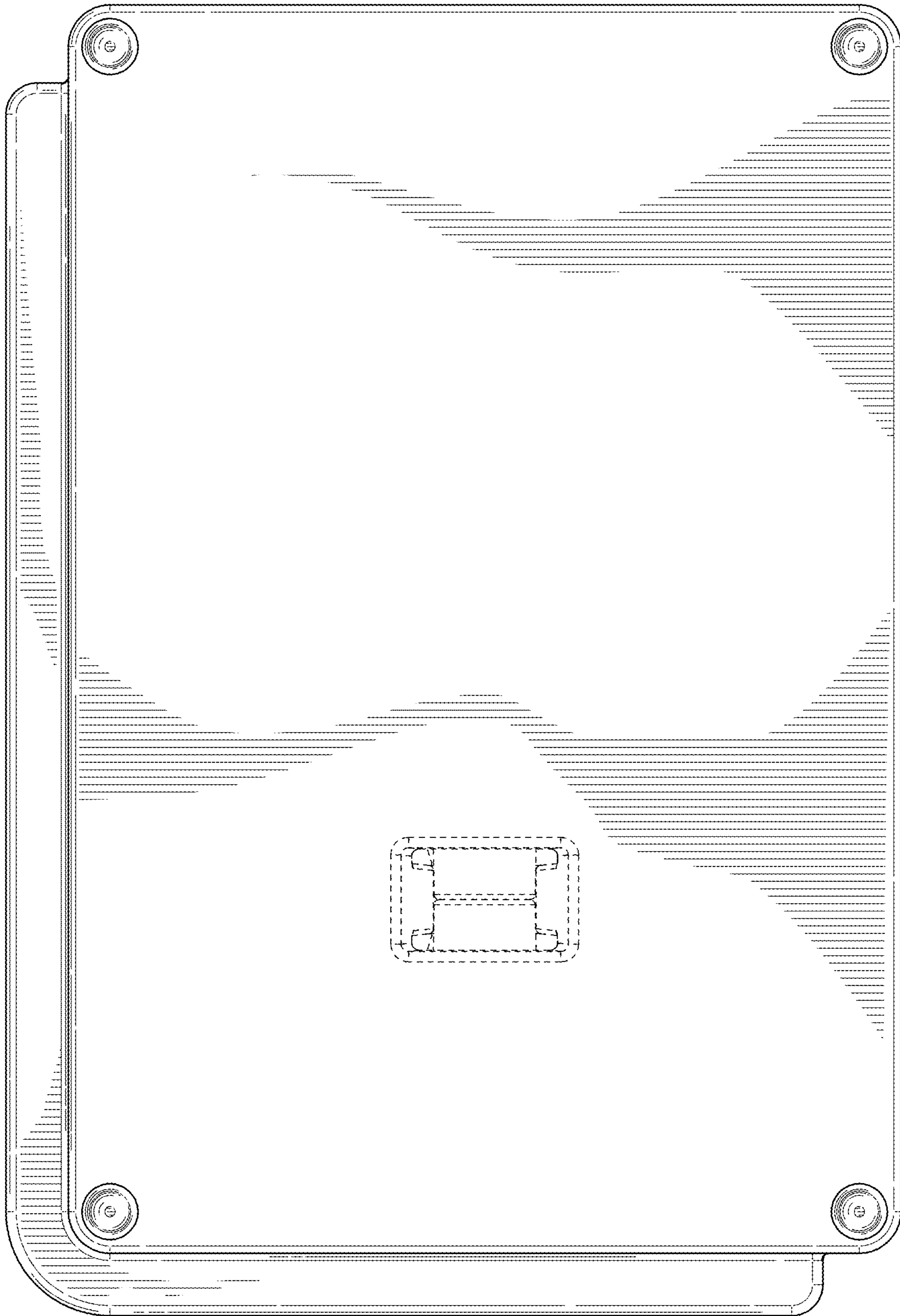

FIG. 28

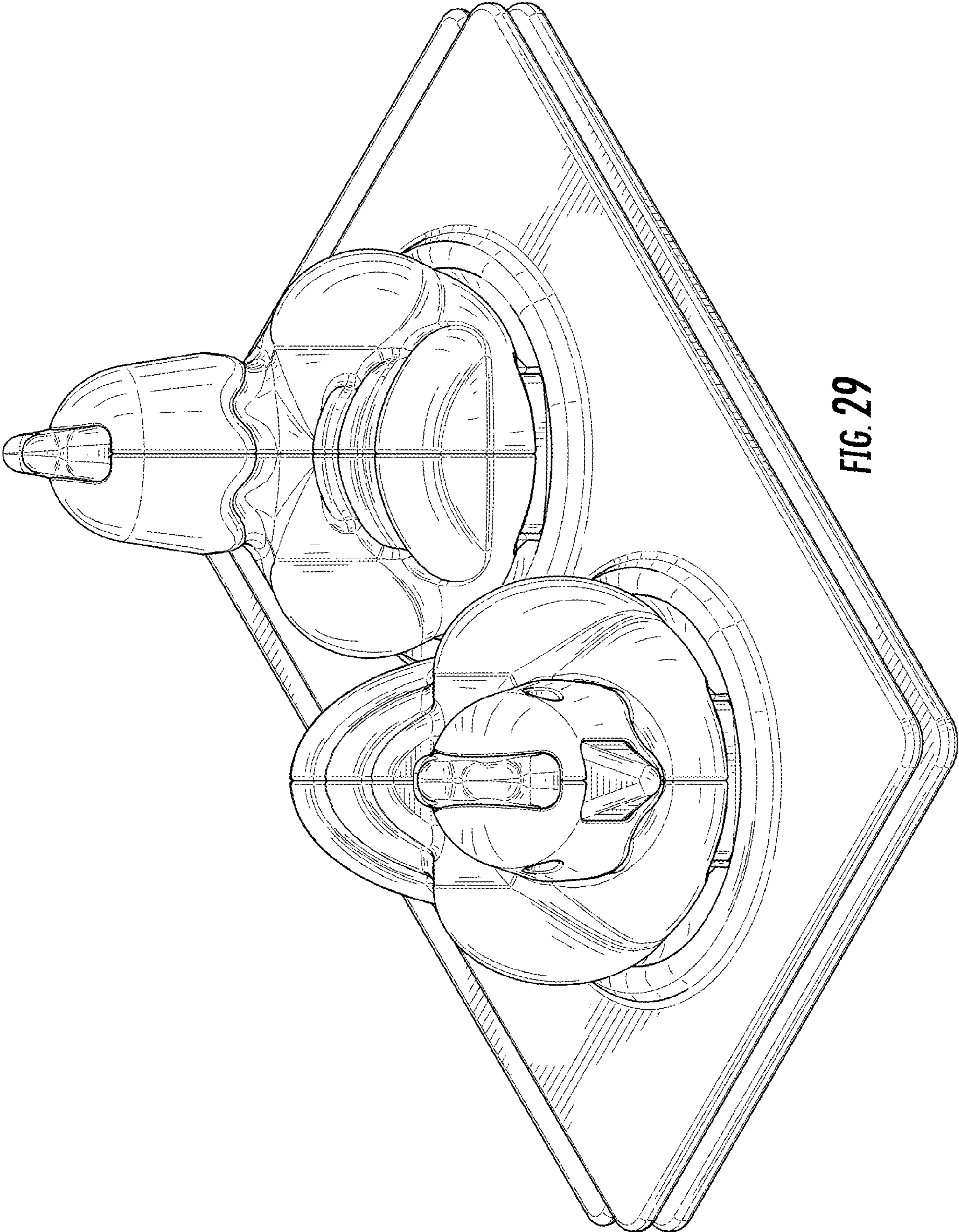

FIG. 29

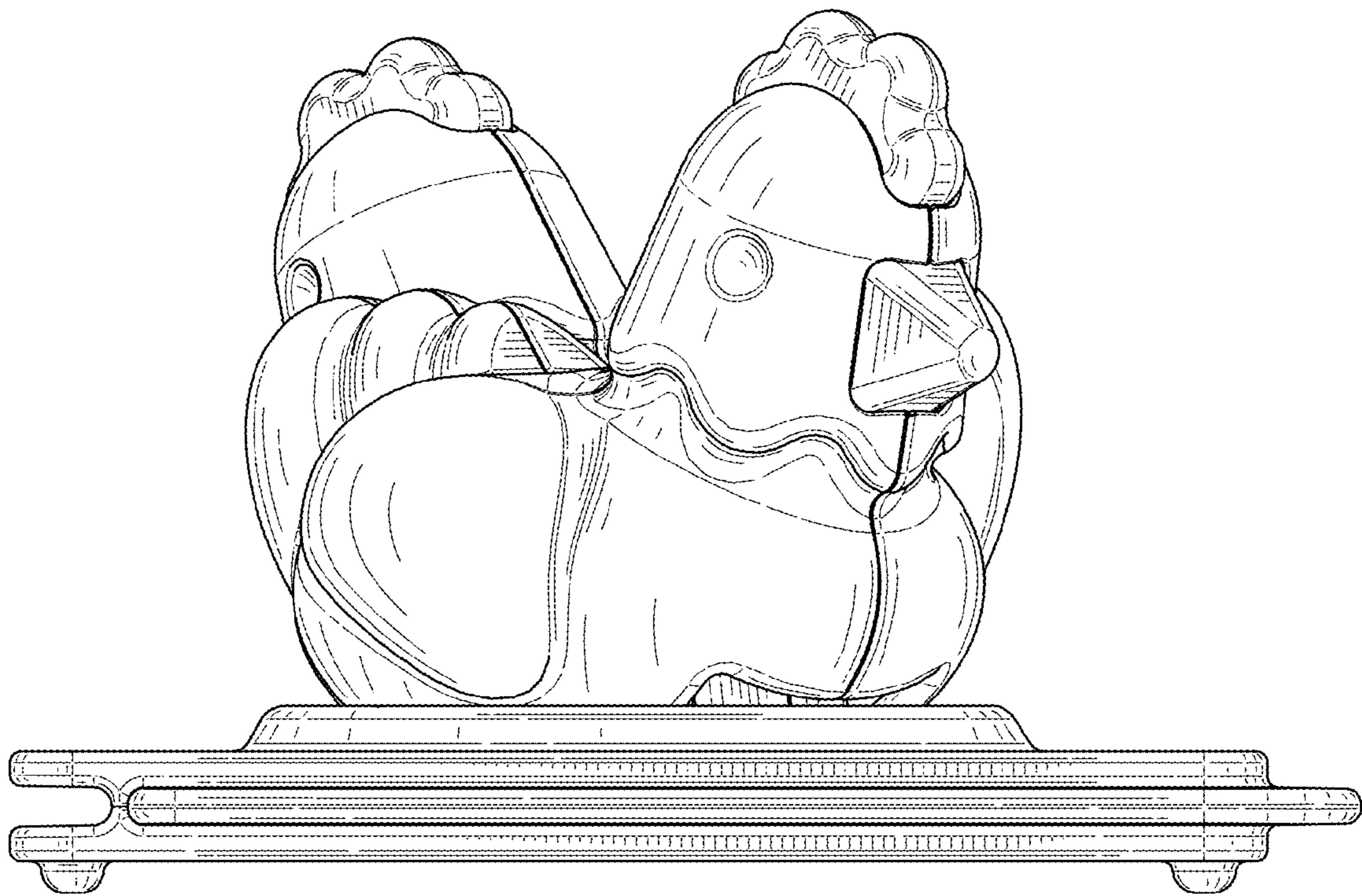

FIG. 30

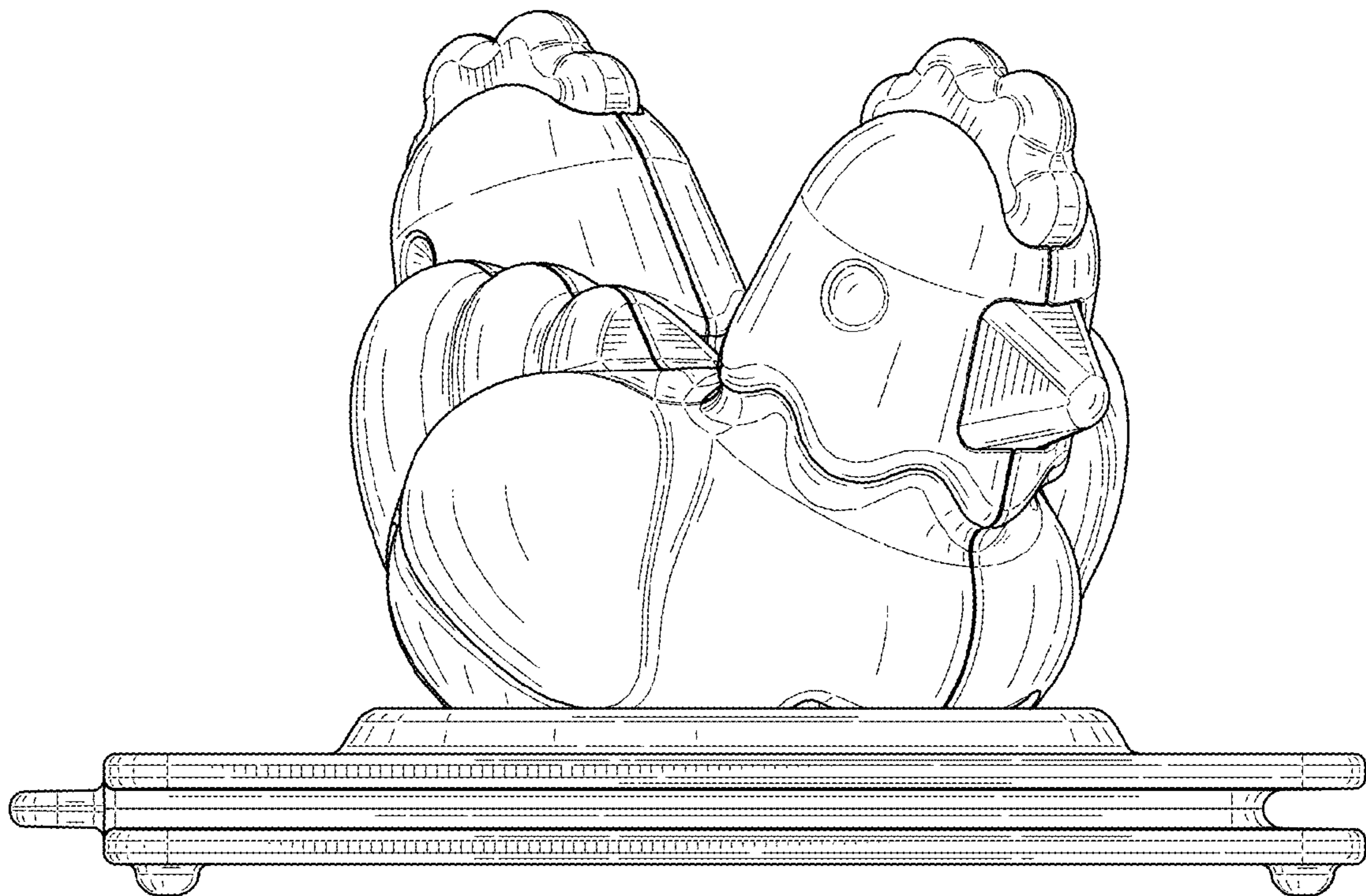

FIG. 31

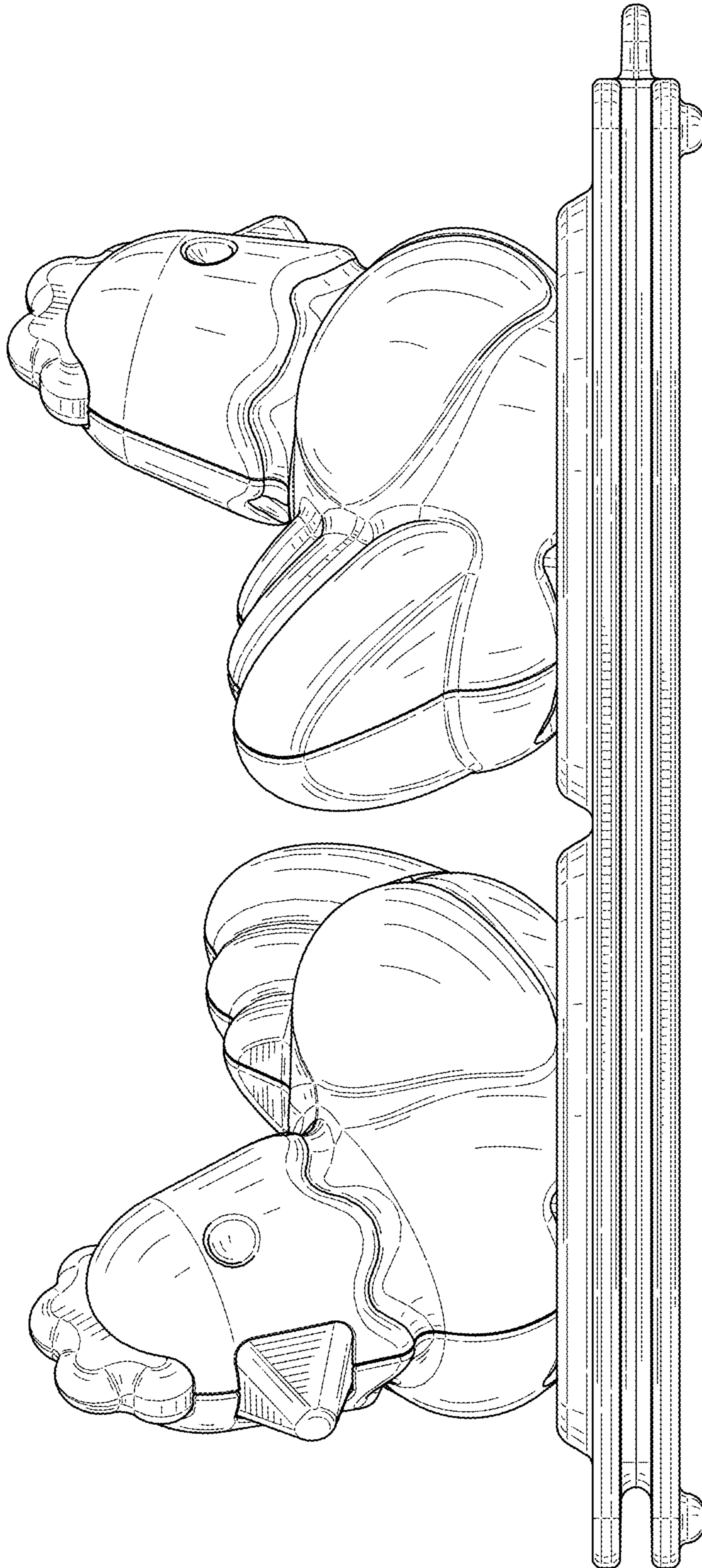

FIG. 32

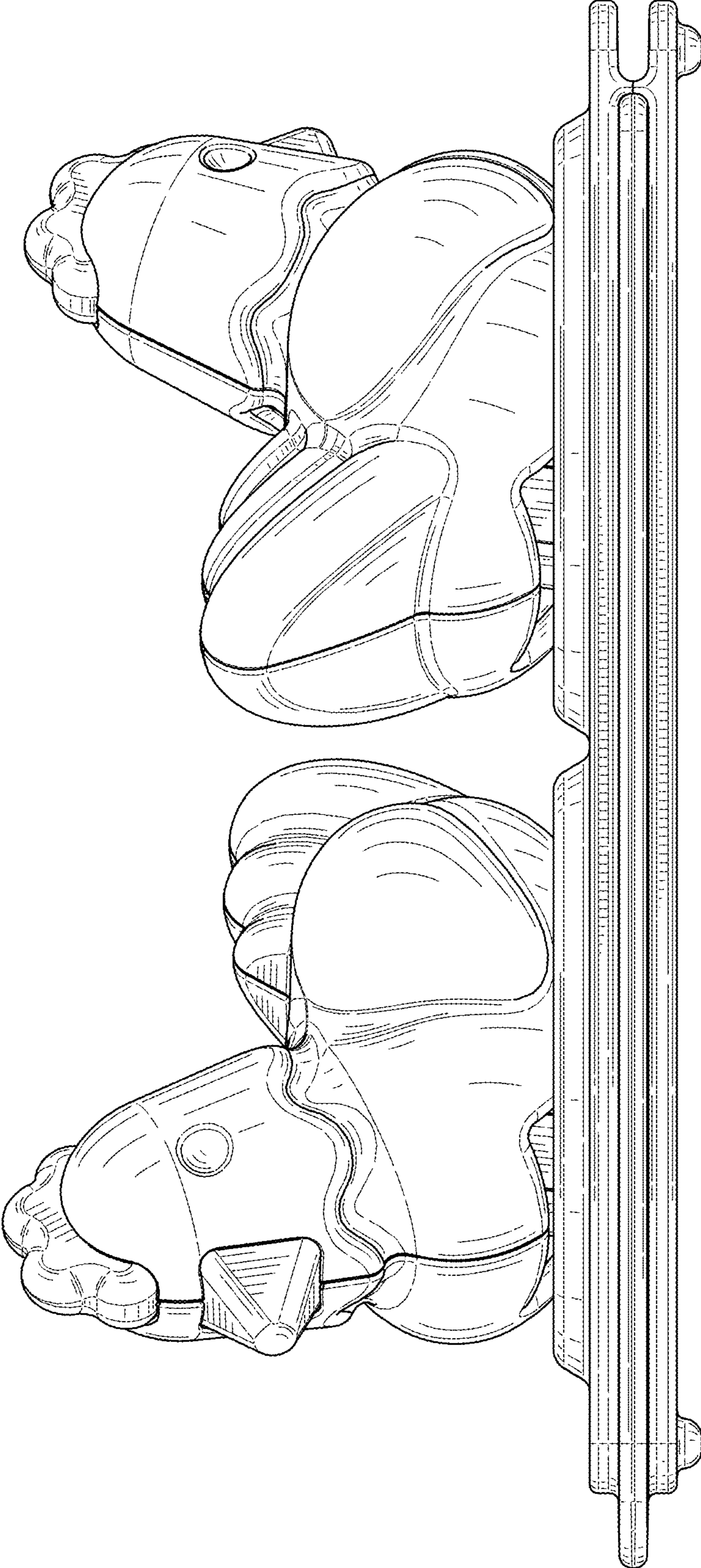

FIG. 33

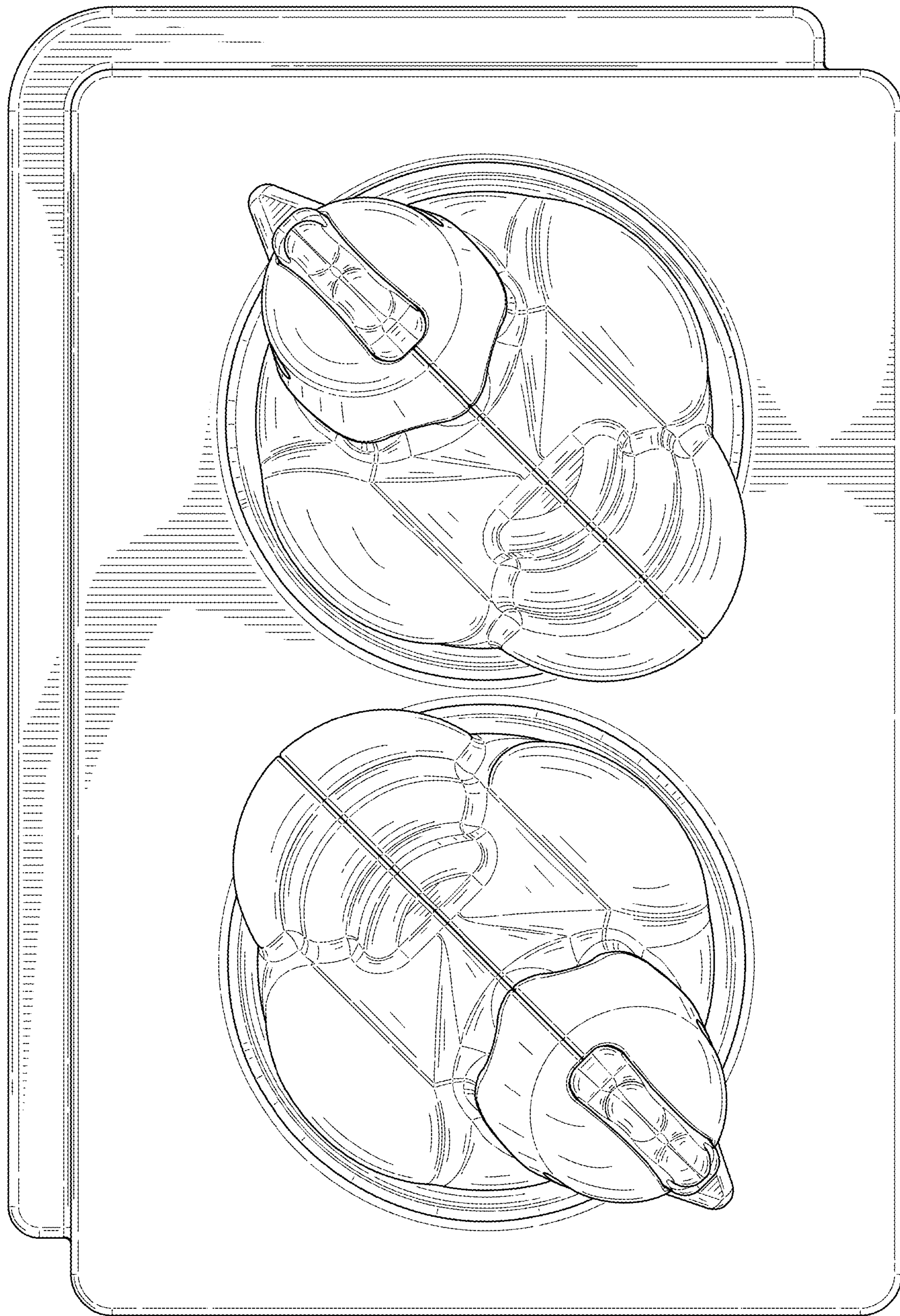

FIG. 34

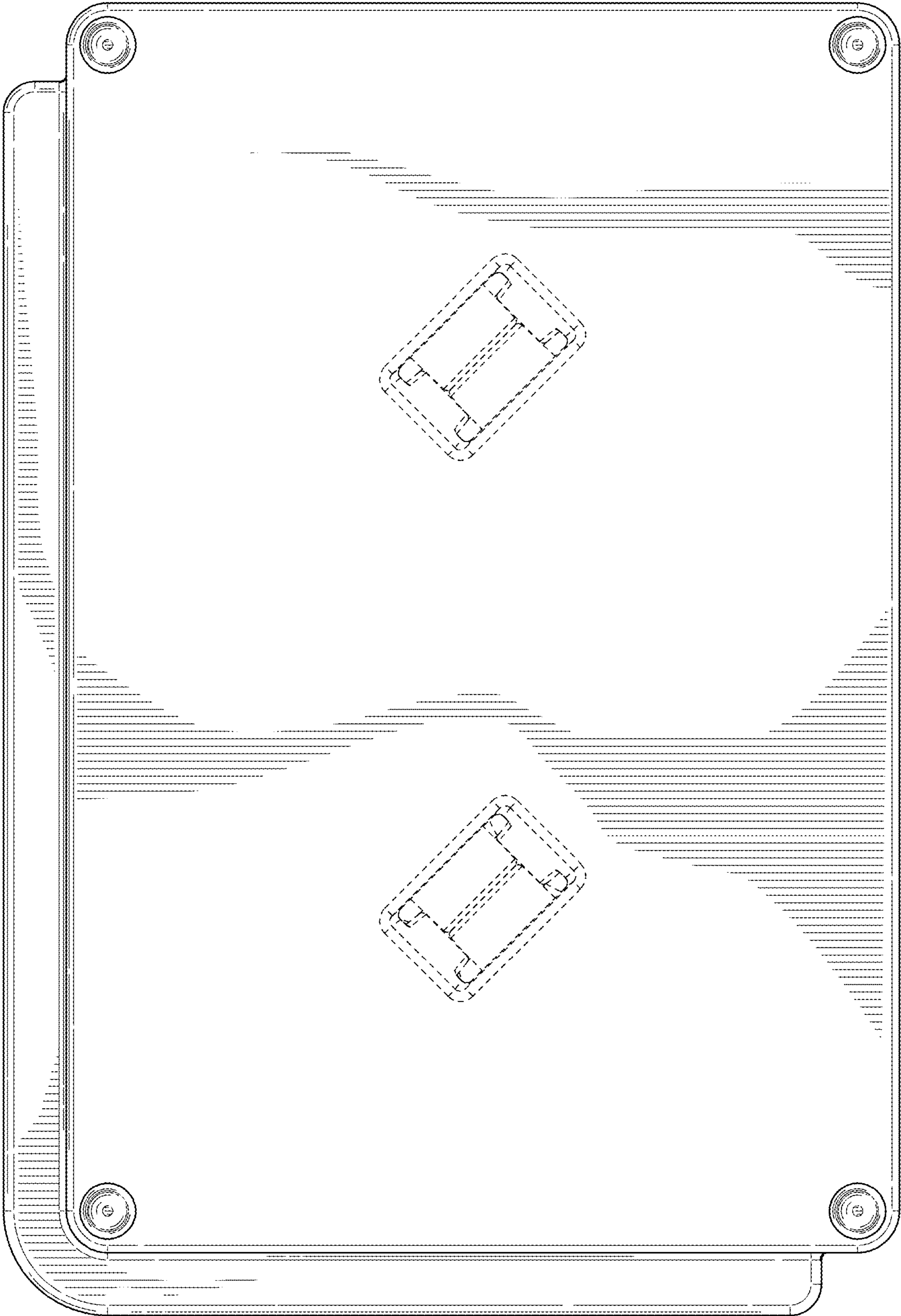

FIG. 35

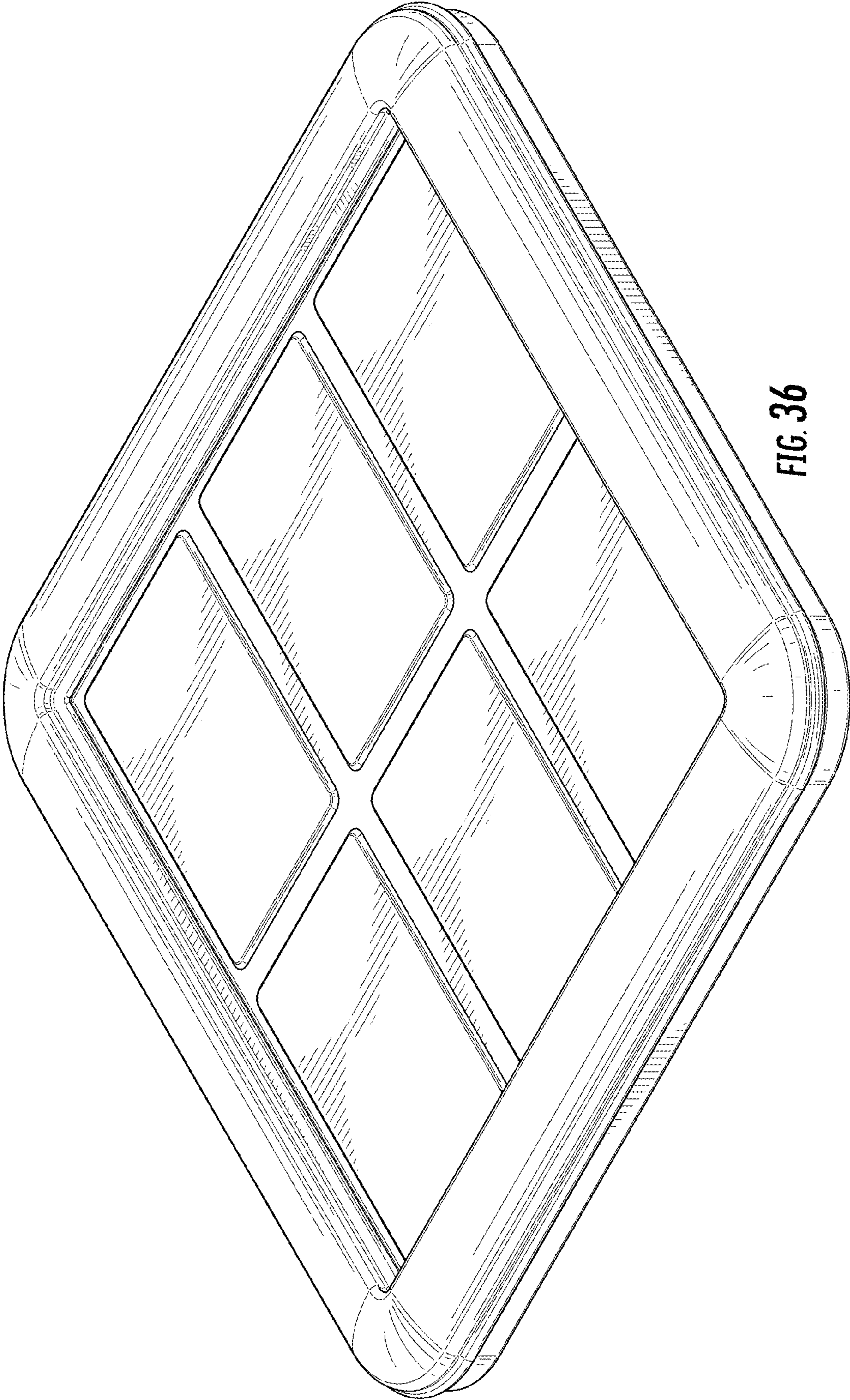

FIG. 36

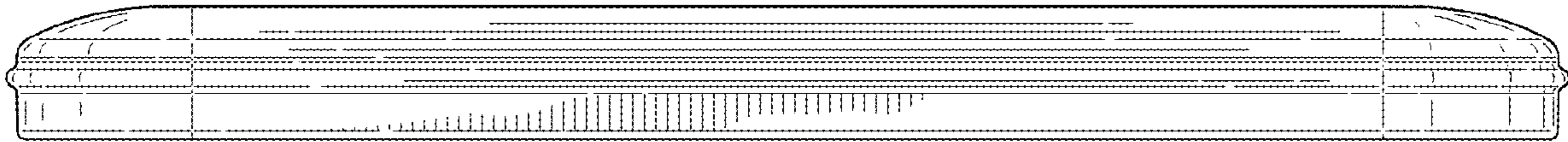

FIG. 37

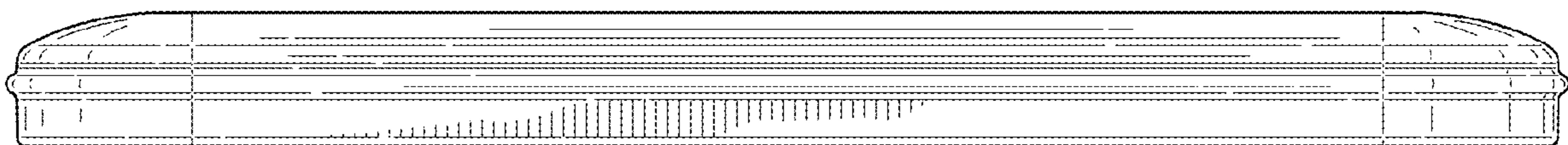

FIG. 38

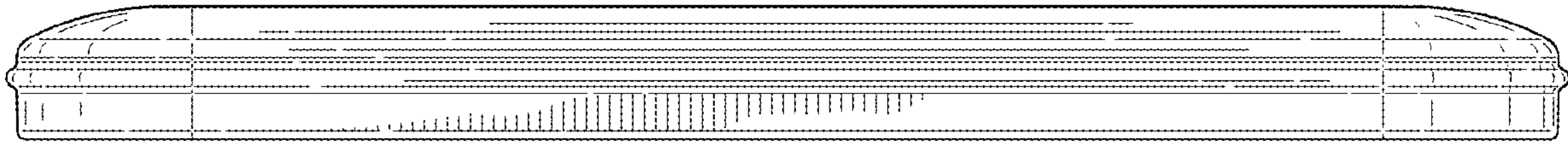

FIG. 39

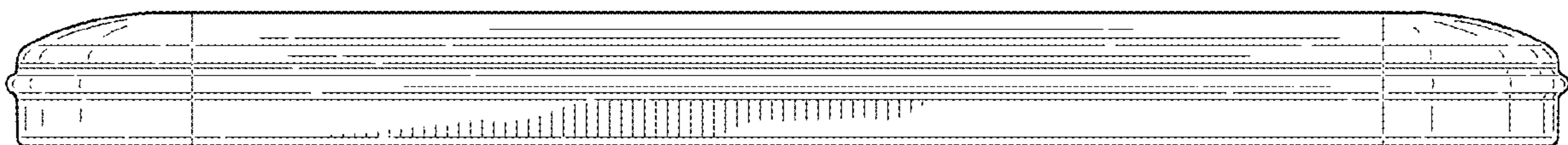

FIG. 40

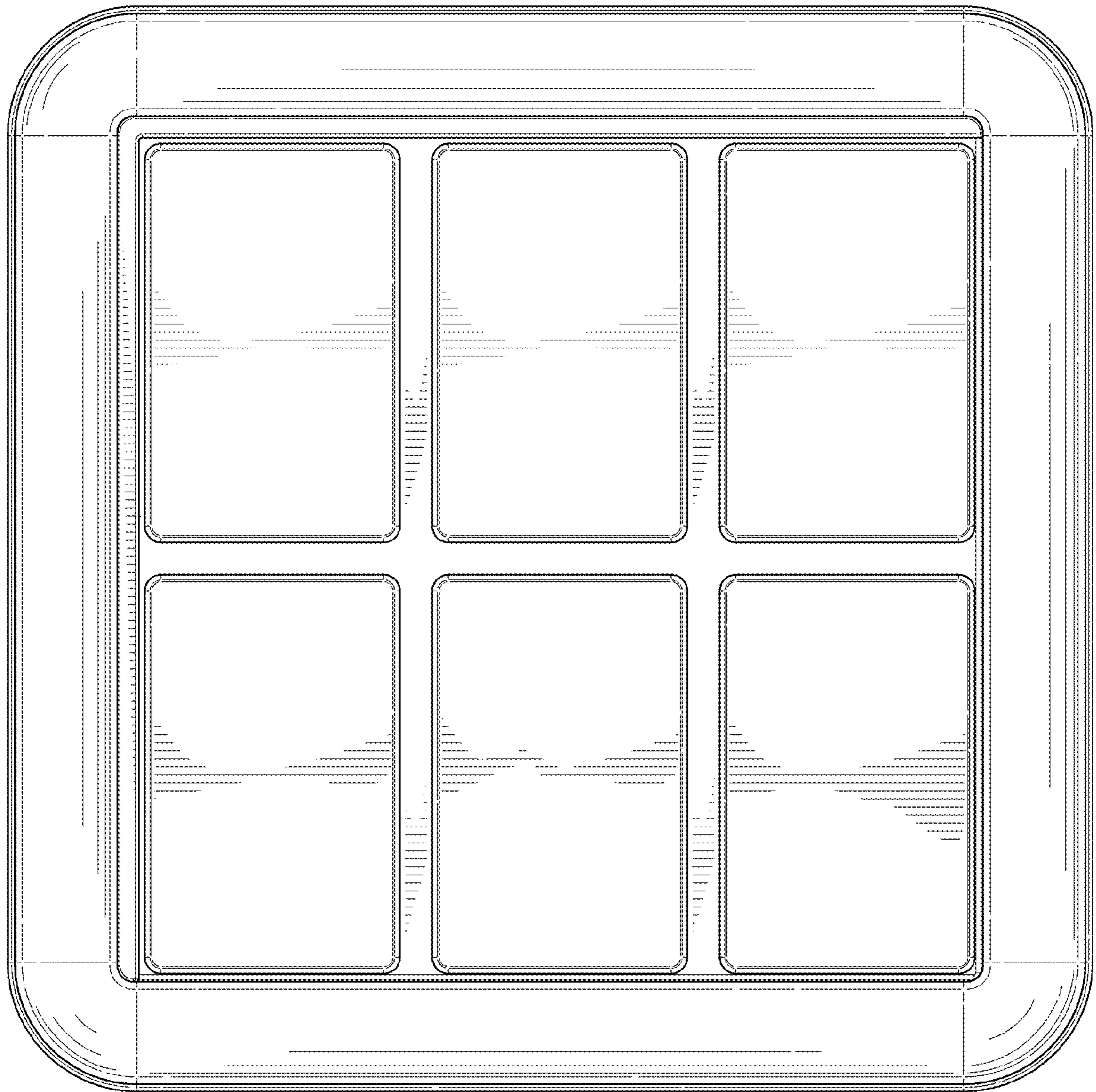

FIG. 41

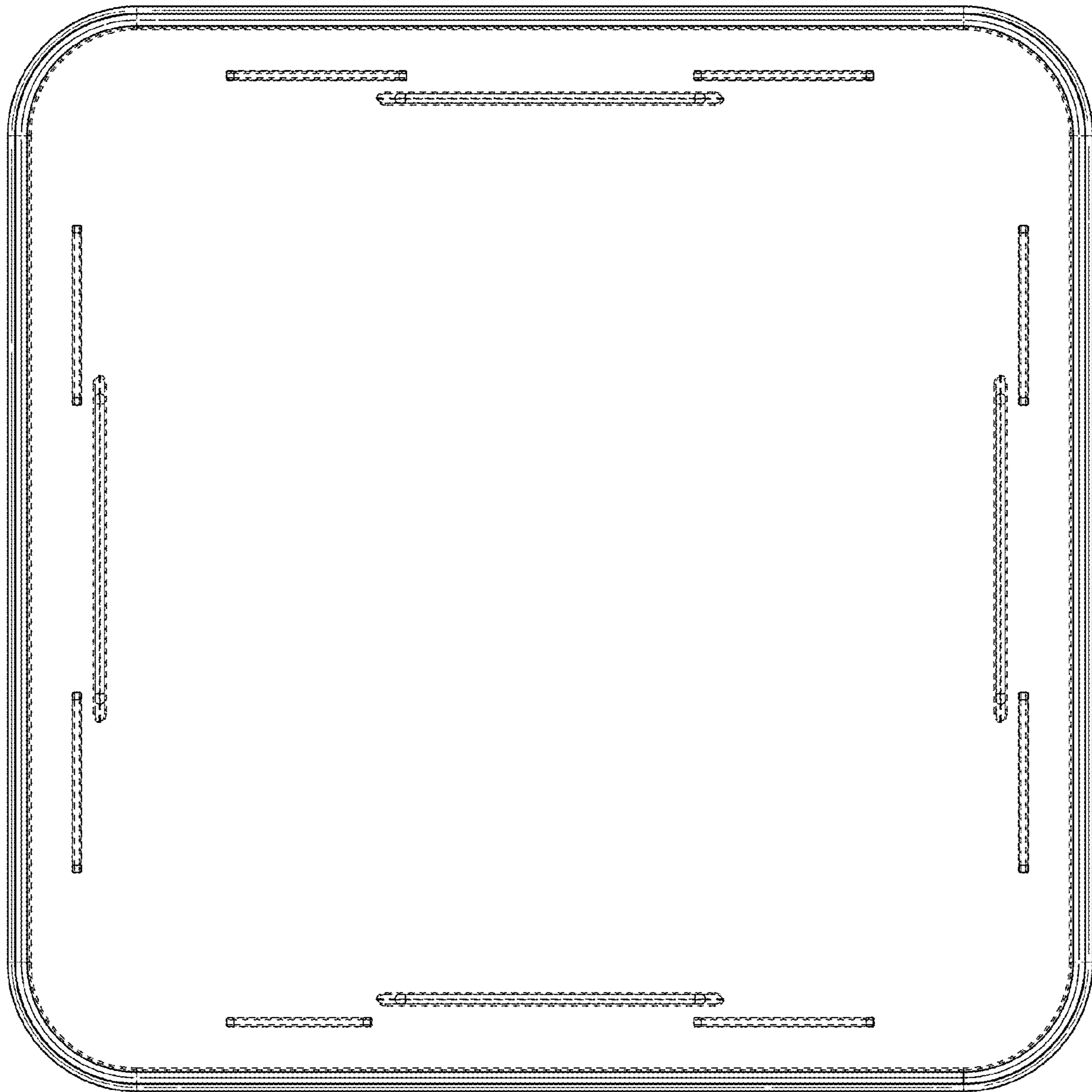

FIG. 42

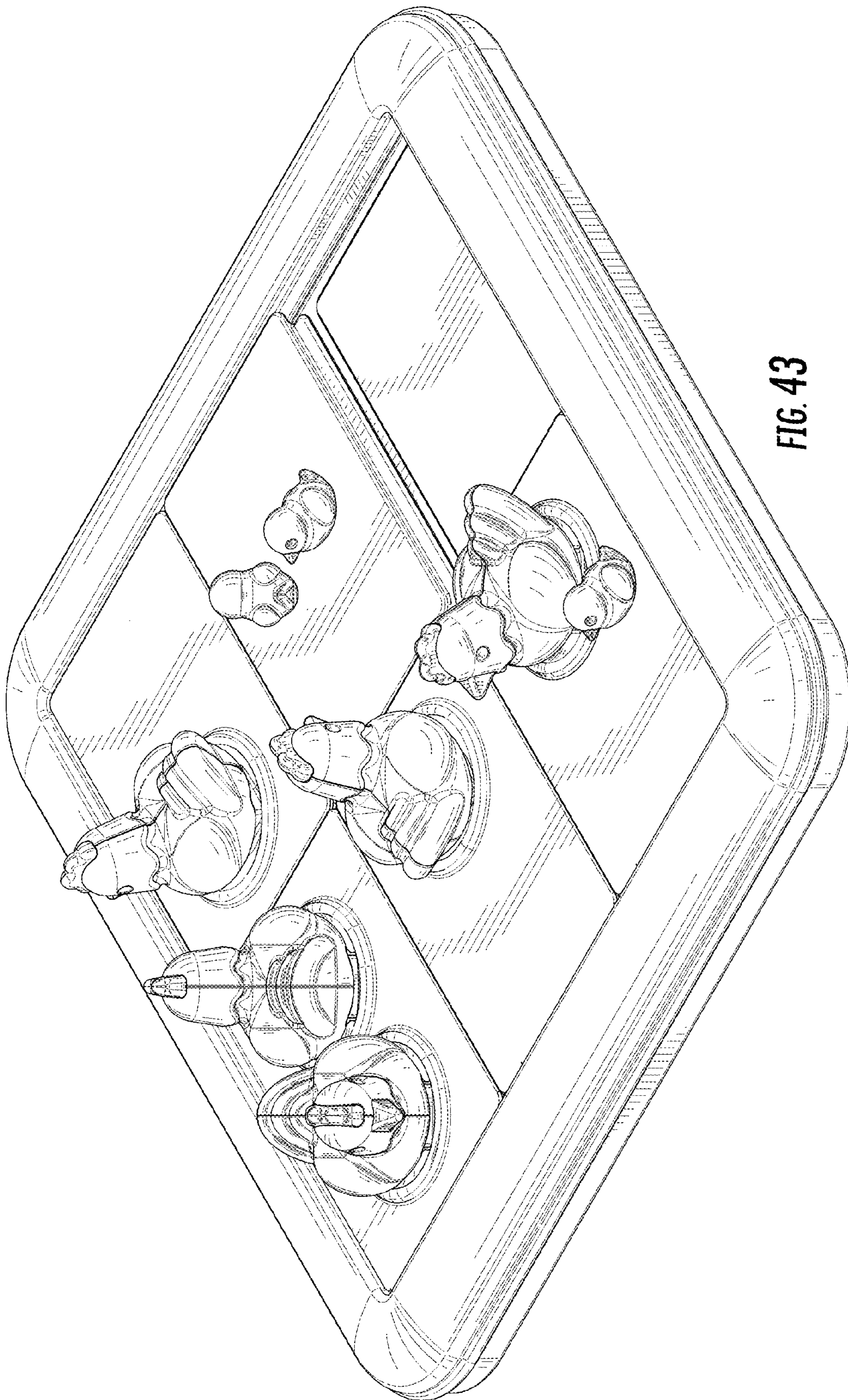

FIG. 43