



US00D942398S

(12) **United States Design Patent**  
**Yang et al.**

(10) **Patent No.:** **US D942,398 S**  
(45) **Date of Patent:** **\*\* Feb. 1, 2022**

(54) **UNINTERRUPTIBLE POWER SUPPLY**

D535,948 S \* 1/2007 Lee ..... D13/139.8  
D549,657 S \* 8/2007 Ng ..... D13/139.8  
D554,064 S \* 10/2007 Ng ..... D13/139.8  
D564,451 S \* 3/2008 Fornino ..... D13/139.8

(71) Applicant: **Eaton Intelligent Power Limited**,  
Dublin (IE)

(Continued)

(72) Inventors: **Kefeng Yang**, Shenzhen (CN); **Jihong Deng**, Shenzhen (CN); **Chuanqing Qi**, Shenzhen (CN)

**FOREIGN PATENT DOCUMENTS**

(73) Assignee: **Eaton Intelligent Power Limited**,  
Dublin (IE)

CN 305057224 \* 3/2019  
EM 007004619-0001 \* 10/2019  
EM 007004619-0002 \* 10/2019

(\*\*) Term: **15 Years**

**OTHER PUBLICATIONS**

(21) Appl. No.: **29/708,716**

“Eaton (3S550)”, first available Apr. 30, 2012. Amazon.com [https://www.amazon.com/Eaton-3S550-550-Desktop-Standby/dp/B00F07T3WE/ref=sr\_1\_7?dchild=1&keywords=eaton+power+supply&qid=16147935%E2%80%A6] (Year: 2012).\*

(22) Filed: **Oct. 9, 2019**

(Continued)

(30) **Foreign Application Priority Data**

Apr. 9, 2019 (CN) ..... 201930157070.1

(51) **LOC (13) Cl.** ..... **13-03**

(52) **U.S. Cl.**  
USPC ..... **D13/139.6**

(58) **Field of Classification Search**  
USPC ..... D13/107, 199, 108, 109, 133, 137.1,  
D13/137.2, 138.1, 139.1, 146, 147 B, 184,  
D13/110, 139.6, 139.7, 139.8; D14/251,  
D14/253, 432, 434; D3/201, 205, 208,  
D3/218, 273, 274, 294

CPC ..... H02J 7/0042; H02J 7/0044; H02J 7/0045;  
H02J 7/0013; H02J 50/00; H02J 50/10;  
H02J 50/12; H02J 50/80; H02J 50/40;  
H02J 50/402; H02J 50/50; H02J 7/025;  
H02J 7/005; H02J 7/0026; H02J 7/0003;  
H02J 9/06; H02J 9/062; H02J 9/068

See application file for complete search history.

*Primary Examiner* — Rosemary K Tarcza

*Assistant Examiner* — Seth David Kumpf

(74) *Attorney, Agent, or Firm* — Stanek Lemon Crouse & Meeks, PA

(56) **References Cited**

**U.S. PATENT DOCUMENTS**

D354,267 S \* 1/1995 Severinsky ..... D13/110  
D467,875 S \* 12/2002 Barger ..... D13/139.8  
D517,484 S \* 3/2006 Wakefield ..... D13/139.8

(57) **CLAIM**

The ornamental design for an uninterruptible power supply, as shown and described.

**DESCRIPTION**

FIG. 1 is a front perspective view of the uninterruptible power supply showing our design;  
FIG. 2 is front view thereof;  
FIG. 3 is back view, opposite the front view of FIG. 2;  
FIG. 4 is a first side view thereof;  
FIG. 5 is a second side view thereof, opposite that shown in FIG. 4;  
FIG. 6 is a top view thereof; and,  
FIG. 7 is a bottom view thereof.  
The broken lines in the drawings illustrate portions of the article that form no part of the claimed design.

**1 Claim, 7 Drawing Sheets**

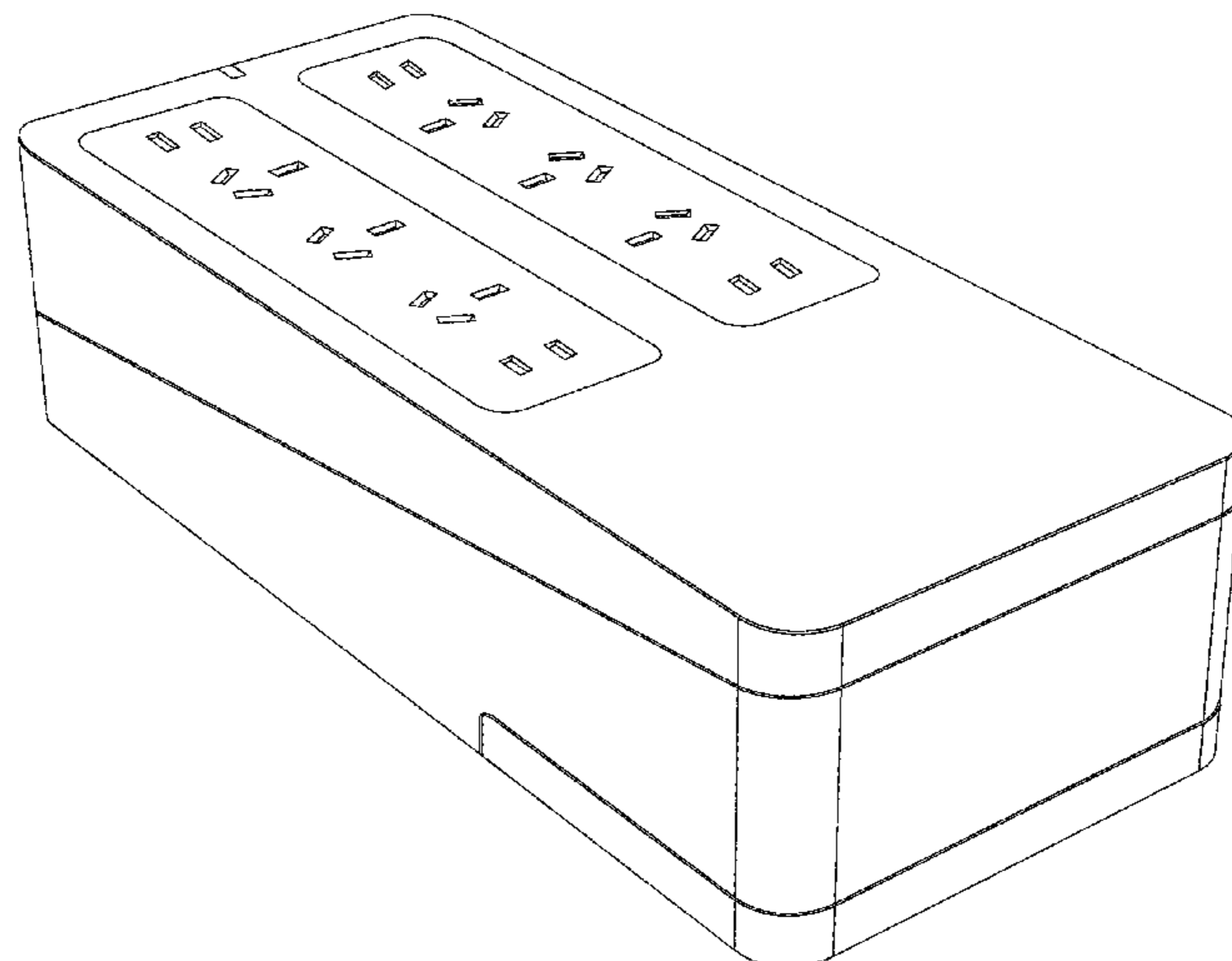

(56)

**References Cited**

U.S. PATENT DOCUMENTS

D593,031 S \* 5/2009 Miyatake ..... D13/110  
 D667,786 S \* 9/2012 Ueda ..... D13/107  
 D696,626 S \* 12/2013 Jacobs ..... D13/110  
 D705,170 S \* 5/2014 Diehl ..... D13/137.1  
 D705,732 S \* 5/2014 Lee ..... D13/137.2  
 D714,214 S \* 9/2014 Wikel ..... D13/107  
 D769,188 S \* 10/2016 Miller ..... D13/108  
 D773,990 S \* 12/2016 Murphy ..... D13/107  
 D773,991 S \* 12/2016 Liu ..... D13/107  
 D801,276 S \* 10/2017 Lin ..... D13/139.7  
 D807,827 S \* 1/2018 Lu ..... D13/137.2  
 D807,828 S \* 1/2018 Xu ..... D13/137.2  
 D808,336 S \* 1/2018 Chien ..... D13/110  
 D820,212 S \* 6/2018 Stern ..... D13/137.2  
 D835,035 S \* 12/2018 Nauroy ..... D13/108  
 D837,736 S \* 1/2019 Liao ..... D13/139.7  
 D844,566 S \* 4/2019 Yu ..... D13/139.7  
 D849,686 S \* 5/2019 Byrne ..... D13/139.7

D852,139 S \* 6/2019 Wen ..... D13/139.7  
 D856,923 S \* 8/2019 Huang ..... D13/139.7  
 2008/0150357 A1\* 6/2008 Teitelbaum ..... H01R 13/6666  
 307/11  
 2010/0020460 A1\* 1/2010 Lee ..... H01R 25/003  
 361/118  
 2010/0165530 A1\* 7/2010 Lee ..... H01R 13/6633  
 361/91.2  
 2016/0197431 A1\* 7/2016 Hsu ..... H01R 31/065  
 200/51 R  
 2016/0352119 A1\* 12/2016 Noh ..... H02J 7/0045

OTHER PUBLICATIONS

“3S550F Eaton UPS”, first accessed Mar. 3, 2021. Omnical.co  
 [https://www.omnical.co/products/eaton/3s550f/3222233?locale=US  
 &gclid=EAIaIQobChMlk\_  
 fNi9eU7wIVkpJbCh1RAAMUEAQYEyABEglbs\_D\_BwE] (Year:  
 2021).\*

\* cited by examiner

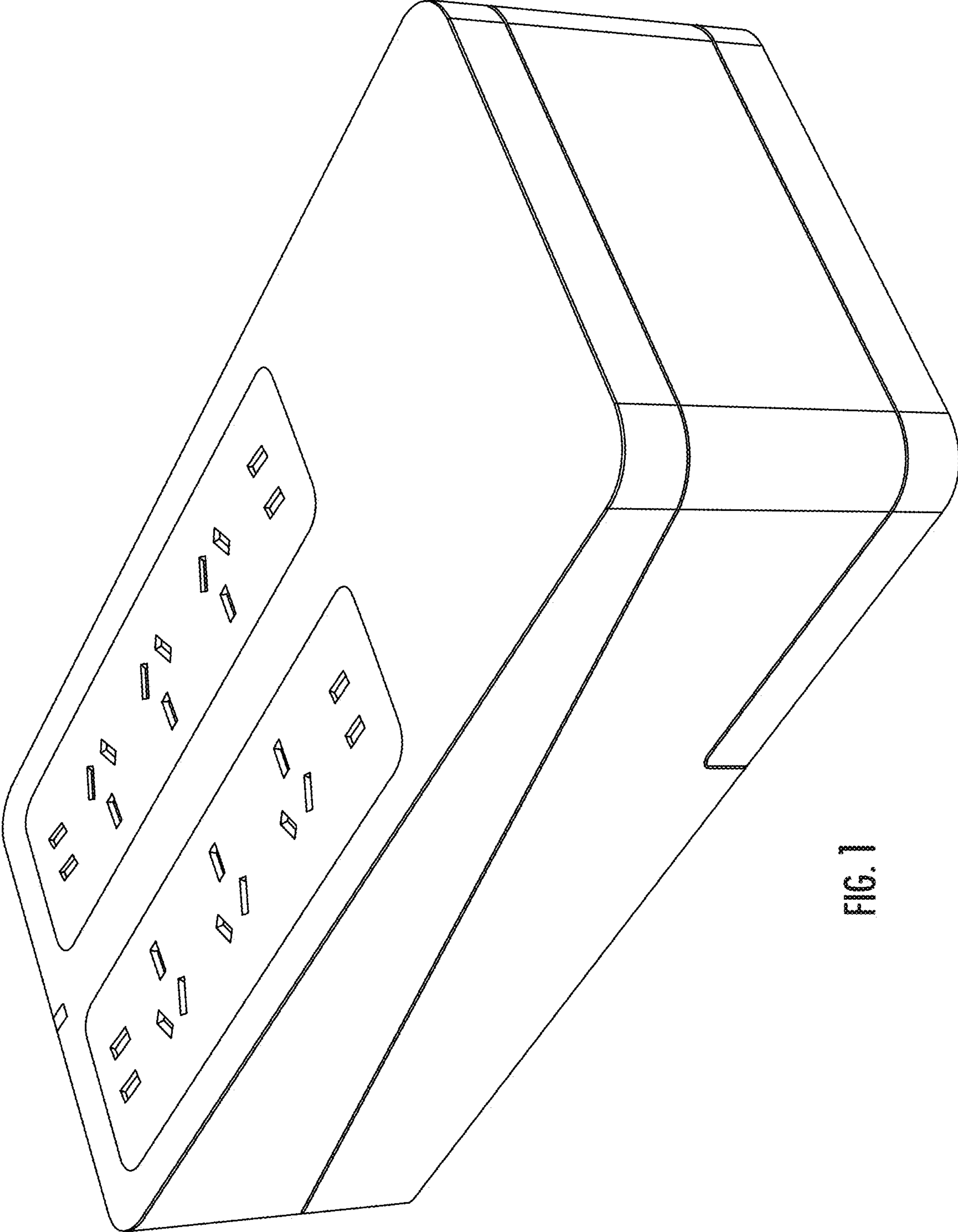
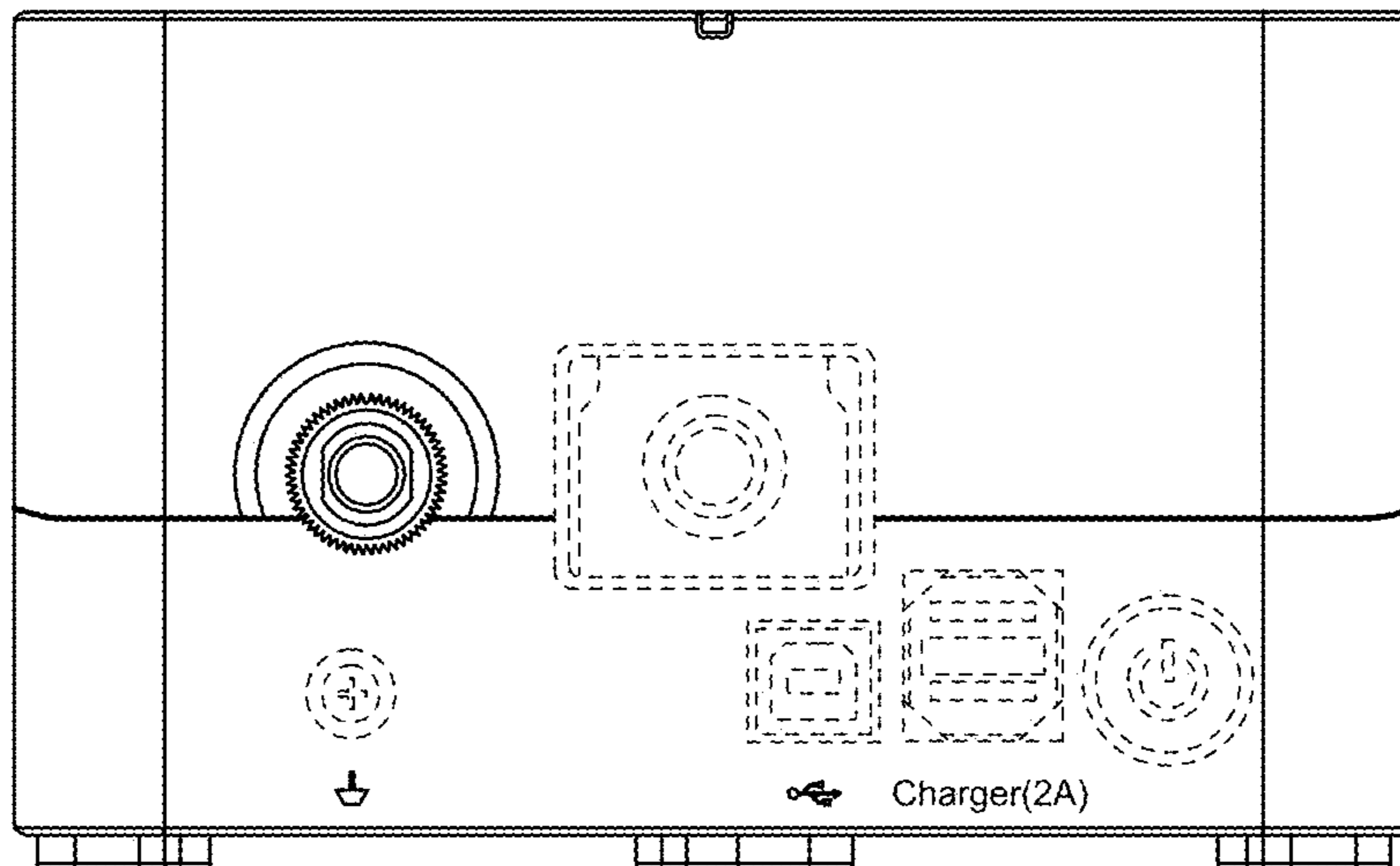

FIG. 1



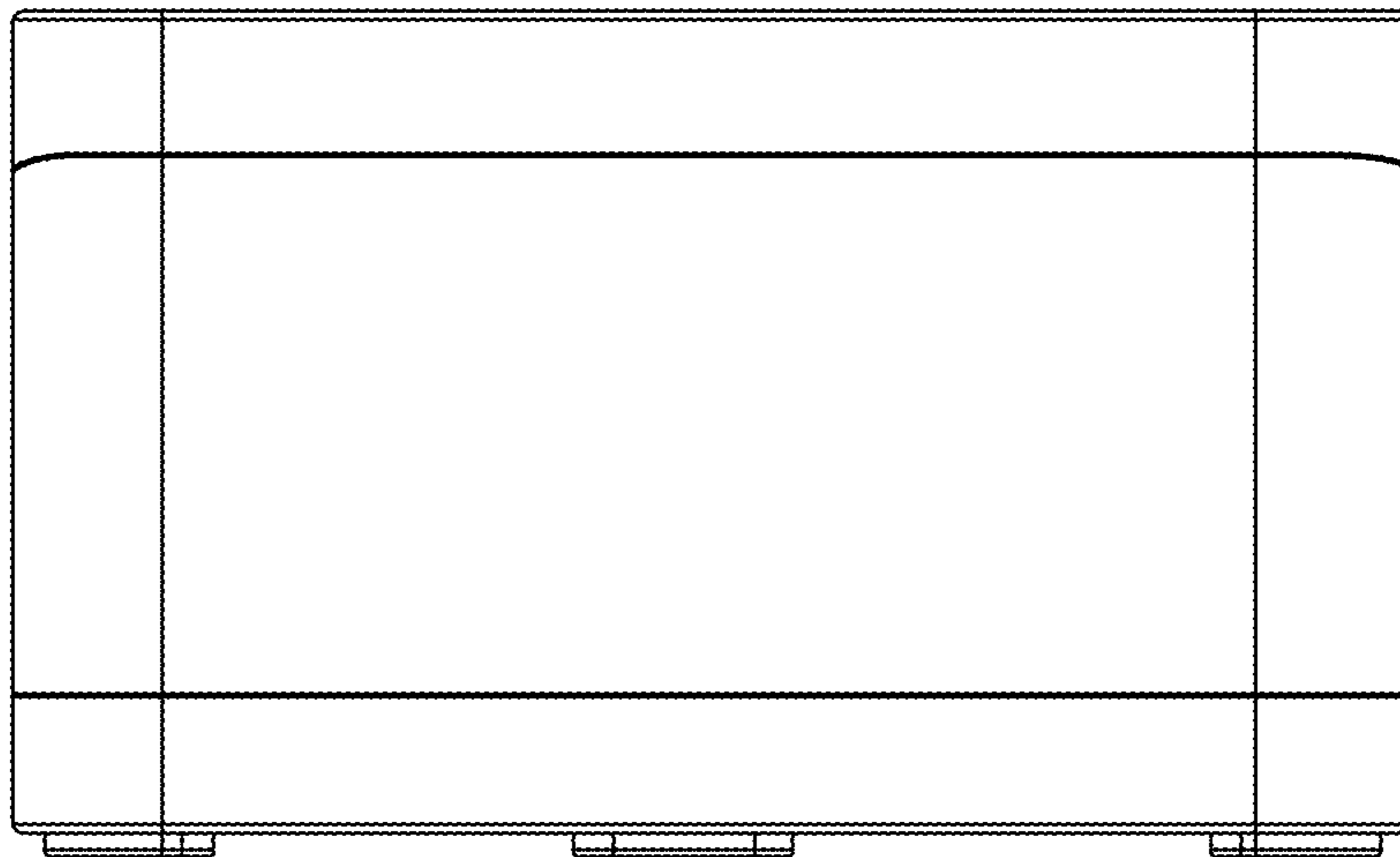

FIG. 3

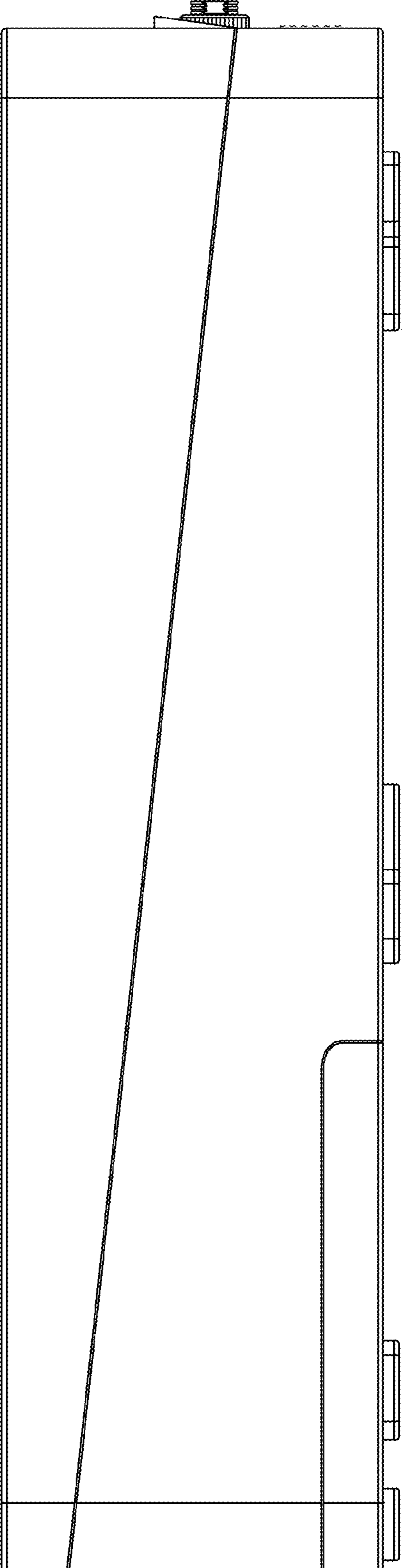

FIG. 4

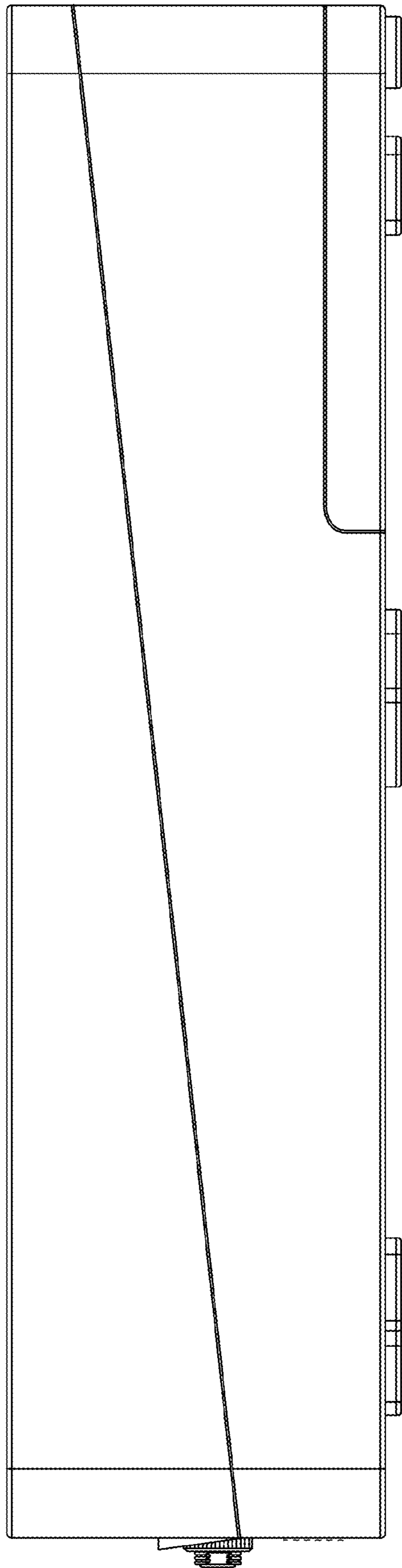

FIG. 5

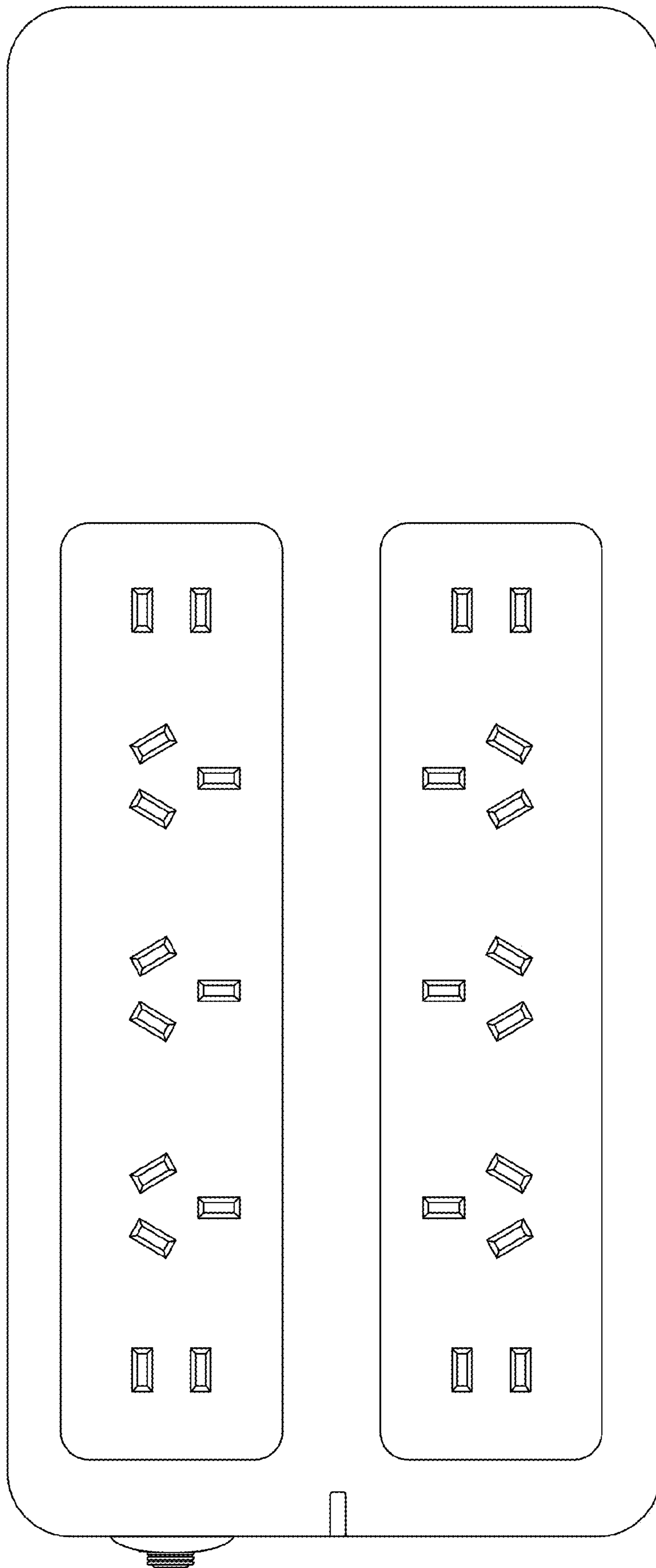

FIG. 6



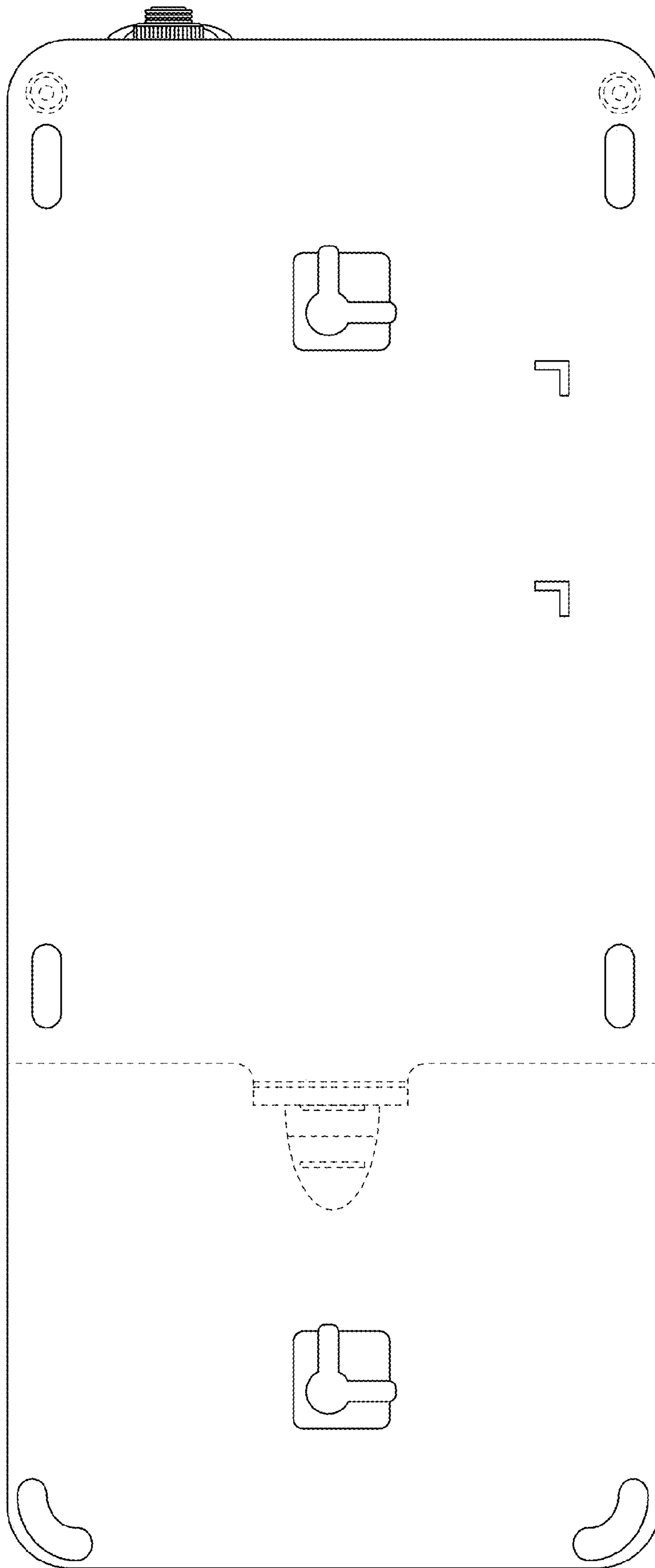

FIG. 7