



US00D942365S

(12) **United States Design Patent** (10) **Patent No.:** **US D942,365 S**  
**Kong** (45) **Date of Patent:** **\*\* Feb. 1, 2022**

(54) **STORAGE NET BAG BETWEEN VEHICLE SEATS**

(71) Applicant: **Wangxing Kong**, Hunan (CN)

(72) Inventor: **Wangxing Kong**, Hunan (CN)

(\*\*) Term: **15 Years**

(21) Appl. No.: **29/743,473**

(22) Filed: **Jul. 22, 2020**

(51) **LOC (13) Cl.** ..... **12-16**

(52) **U.S. Cl.**  
USPC ..... **D12/416**

(58) **Field of Classification Search**  
USPC ..... D12/416, 415, 417-419, 423; D6/513, D6/514, 611, 553, 556, 559; D7/601-602, 605-607; D3/216, 217, 319  
CPC .... B65D 33/00; B64D 11/0636; B60N 3/004; B60R 7/14; B60R 7/08  
See application file for complete search history.

(56) **References Cited**

**U.S. PATENT DOCUMENTS**

D875,644 S \* 2/2020 Goatcher ..... D12/425  
D880,198 S \* 4/2020 Umlauf ..... D6/611  
D881,793 S \* 4/2020 Huang ..... D12/416

D902,629 S \* 11/2020 Umlauf ..... D6/611  
D904,798 S \* 12/2020 Cameron ..... D6/611  
D911,257 S \* 2/2021 Yarbrough ..... D12/416  
D913,909 S \* 3/2021 Guo ..... D12/416  
D929,775 S \* 9/2021 Templeton ..... D6/611  
D931,186 S \* 9/2021 Ye ..... D12/415  
D931,187 S \* 9/2021 Huang ..... D12/416  
2003/0085246 A1 \* 5/2003 Reisman ..... B60R 7/043 224/275  
2006/0021685 A1 \* 2/2006 Cho ..... A45C 13/00 150/113

\* cited by examiner

*Primary Examiner* — Katrina A Betton

(57) **CLAIM**

The ornamental design for a storage net bag between vehicle seats, as shown and described.

**DESCRIPTION**

FIG. 1 is a perspective view of a storage net bag between vehicle seats showing my new design; FIG. 2 is a front elevational view thereof; FIG. 3 is a rear elevational view thereof; FIG. 4 is a left side elevational view thereof; FIG. 5 is a right side elevational view thereof; FIG. 6 is a top plan view thereof; and, FIG. 7 is a bottom plan view thereof. The broken lines shown in the drawings depict stitching which forms part of the claimed design.

**1 Claim, 7 Drawing Sheets**

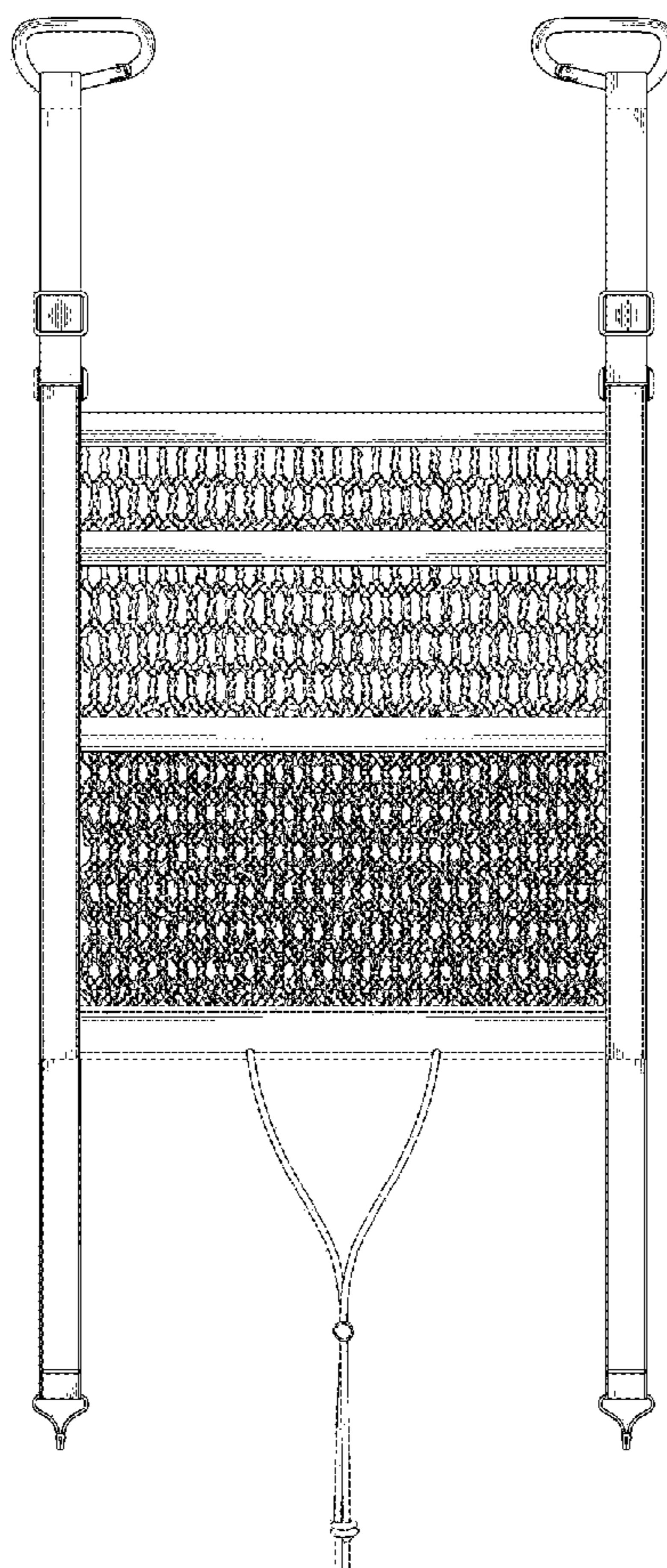

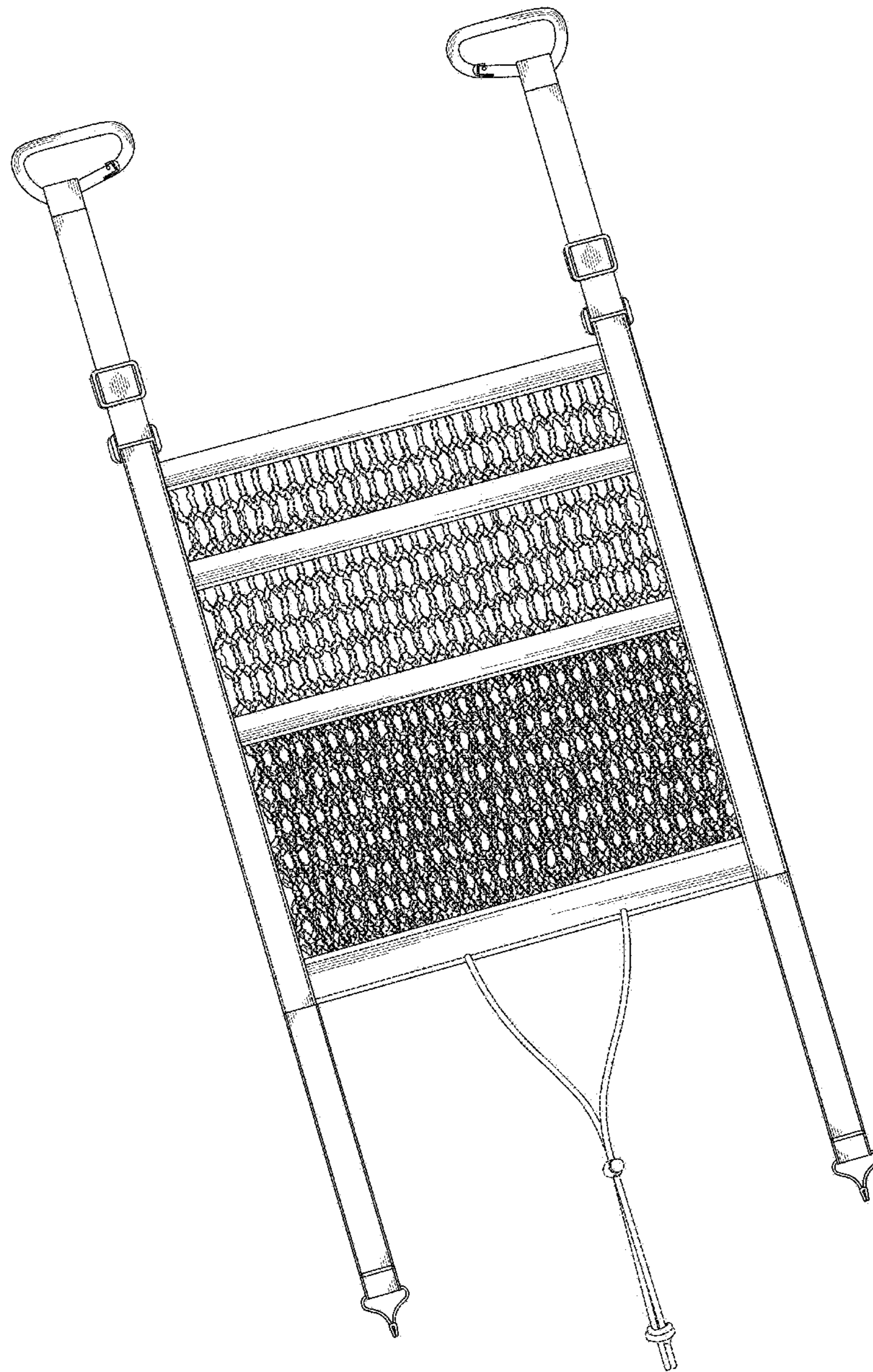

FIG. 1

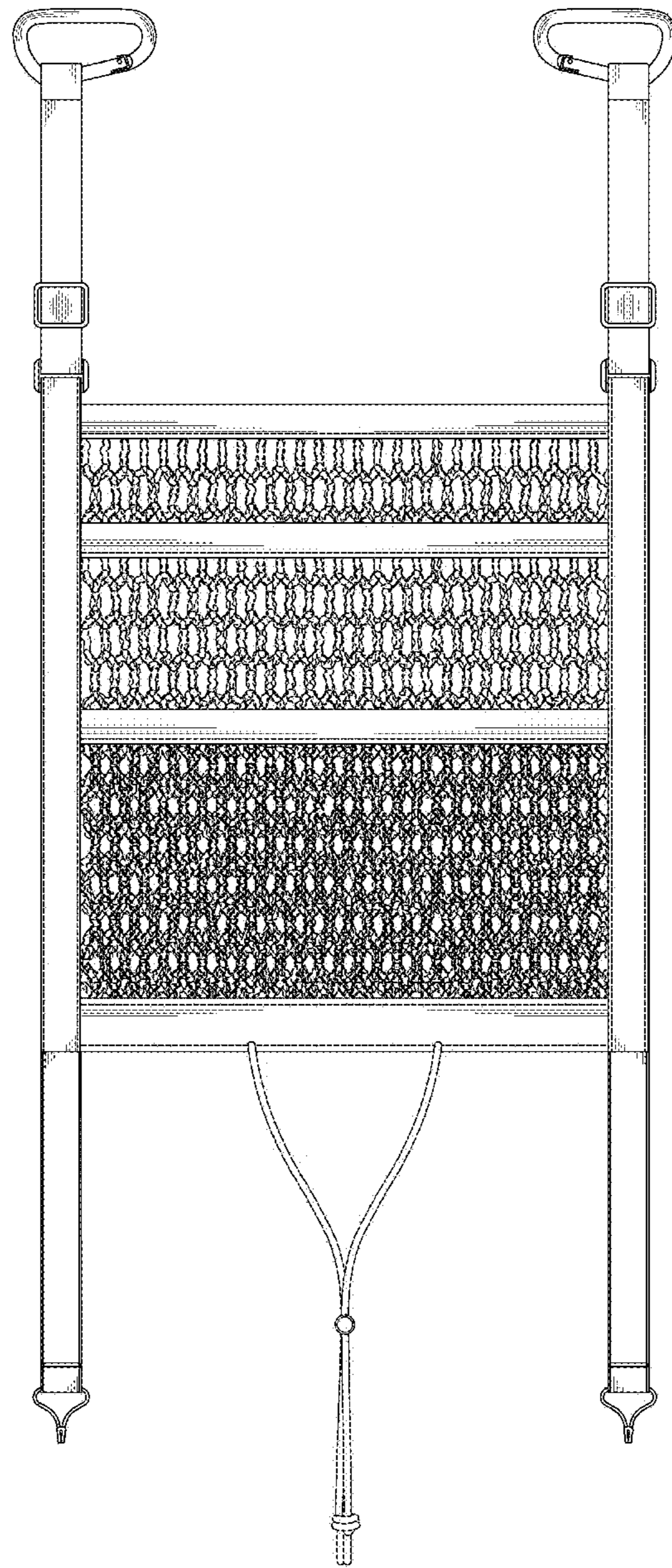

FIG. 2

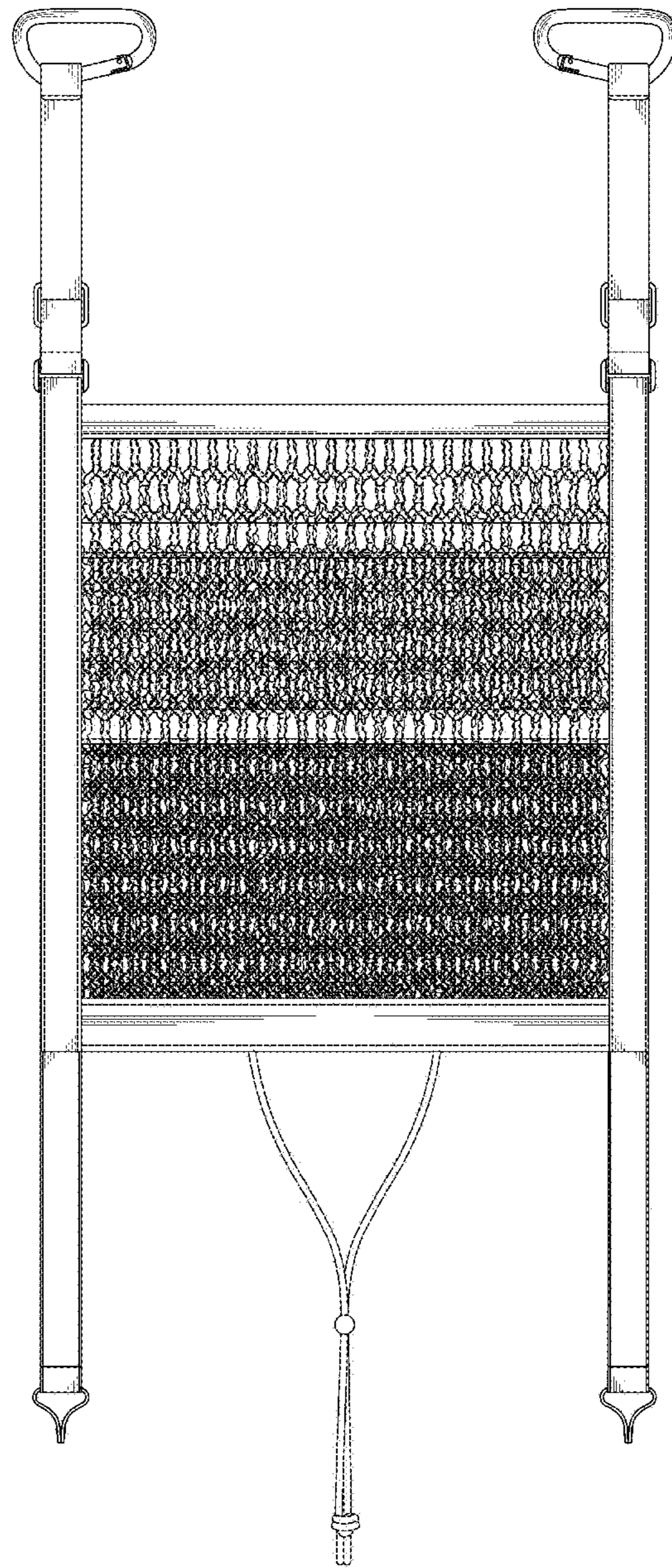

FIG. 3

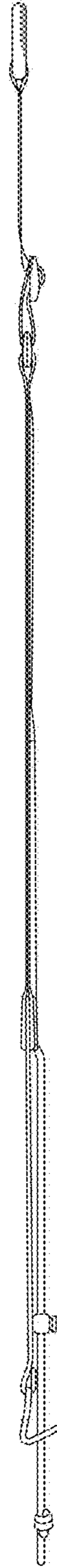

FIG. 4

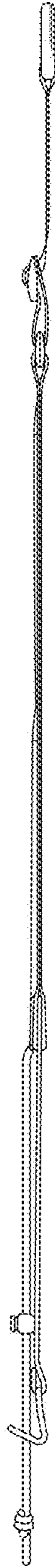

FIG. 5



FIG. 6

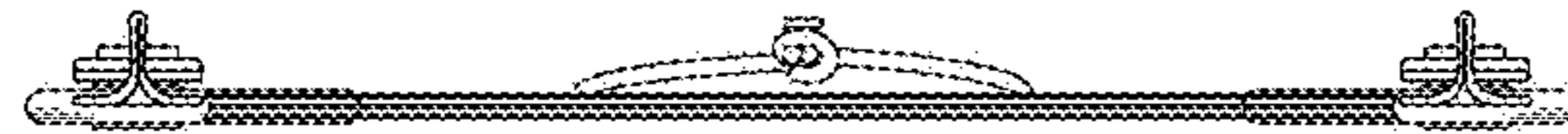

FIG. 7