



US00D942308S

(12) **United States Design Patent** (10) **Patent No.:** **US D942,308 S**
Yatsugi-Kang (45) **Date of Patent:** **** Feb. 1, 2022**

(54) **PAIR OF EARRINGS**

(71) Applicant: **Harry Winston SA**, Plan-les-Ouates (CH)
(72) Inventor: **Rie Yatsugi-Kang**, New York, NY (US)
(73) Assignee: **Harry Winston SA**, Plan-les-Ouates (CH)
(**) Term: **15 Years**

(21) Appl. No.: **29/729,067**

(22) Filed: **Mar. 24, 2020**

(30) **Foreign Application Priority Data**

Oct. 21, 2019 (WO) DM/204690

(51) **LOC (13) Cl.** **11-01**

(52) **U.S. Cl.**
USPC **D11/43**

(58) **Field of Classification Search**
USPC D11/1-18, 26, 30, 39, 40-49, 56-58, 60, D11/61, 64, 72, 75-76, 78-86, 95-100, D11/102, 103, 115, 116; D3/207-212, D3/232, 318; D2/946
CPC .. A44C 1/00; A44C 3/00; A44C 3/001; A44C 3/004; A44C 3/005; A44C 5/00; A44C 5/02; A44C 7/00; A44C 7/002; A44C 7/003; A44C 7/004; A44C 7/005; A44C 7/006; A44C 7/007; A44C 7/008; A44C 9/00; A44C 9/003; A44C 9/0007; A44C 9/0015; A44C 9/0023; A44C 15/00; A44C 15/0015; A44C 15/002; A44C 15/0025; A44C 15/005; A44C 15/0055; A44C 21/00; A44C 23/00; A44C 25/00; A44C 25/001; A44C 25/002; A44C 25/005; A44C 25/007; A44C 25/008

See application file for complete search history.

(56) **References Cited**

U.S. PATENT DOCUMENTS

D279,879 S * 7/1985 Moon D11/43
D308,949 S * 7/1990 Bulgari D11/42
D685,667 S * 7/2013 Papadimitriou D11/43
D728,410 S * 5/2015 Yatsugi-Kang D11/43

FOREIGN PATENT DOCUMENTS

WO D096822-007 * 9/2017

OTHER PUBLICATIONS

Black Label Diamond Chandelier Earrings, available 2021, online, site visited Sep. 25, 2021. Available from internet, URL: <https://www.forevermark.com/en-us/products/black-label-diamond-chandelier-earrings-9928/> (Year: 2021).*

(Continued)

Primary Examiner — W. A. Teddy Falloway
Assistant Examiner — Sarah J Ault
(74) *Attorney, Agent, or Firm* — Blank Rome LLP

(57) **CLAIM**

The ornamental design for a pair of earrings, as shown and described.

DESCRIPTION

FIG. 1 is a front view of a pair of earrings of the present design;
FIG. 2 is a rear view thereof;
FIG. 3 is a right side view thereof;
FIG. 4 is a left side view thereof;
FIG. 5 is a top rear perspective view thereof;
FIG. 6 is a bottom rear perspective view thereof;
FIG. 7 is a front right perspective view thereof; and,
FIG. 8 is a rear left perspective view thereof.

1 Claim, 8 Drawing Sheets

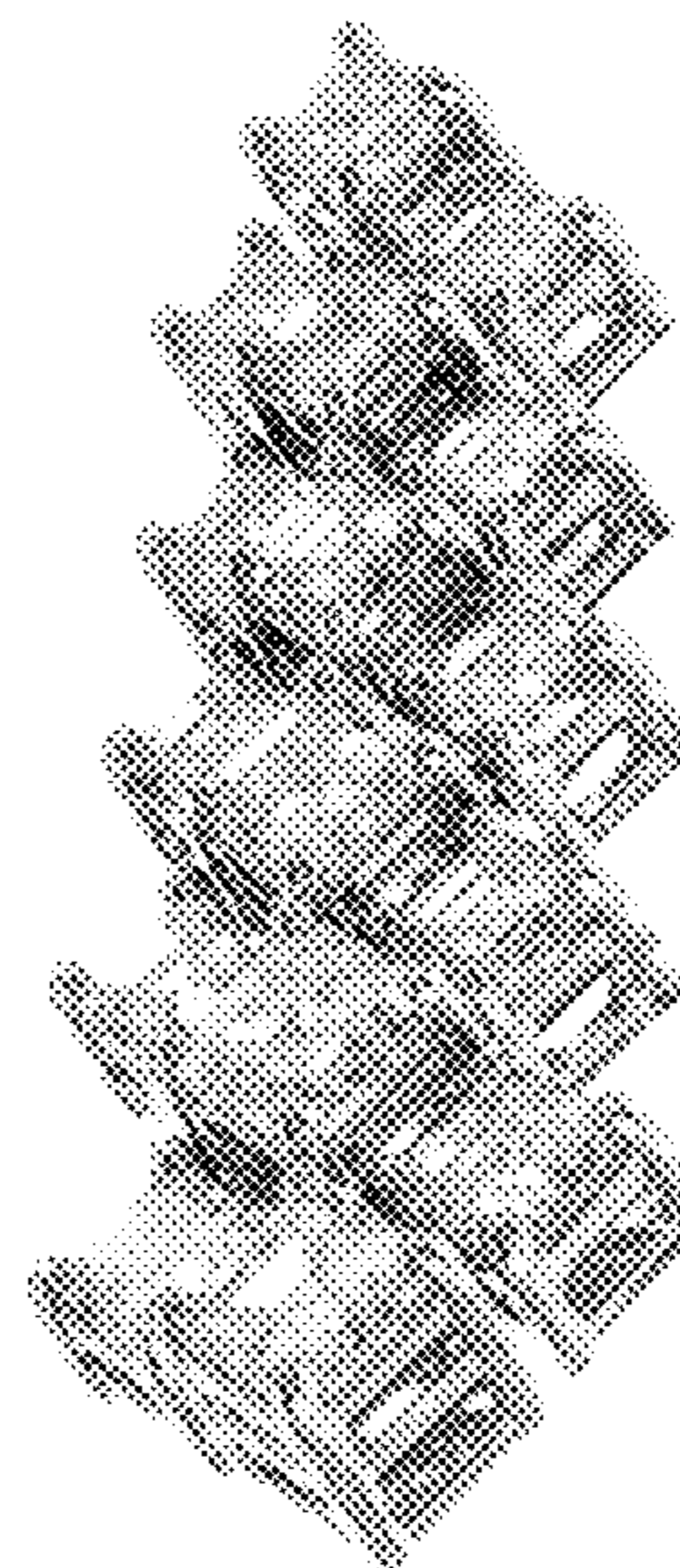
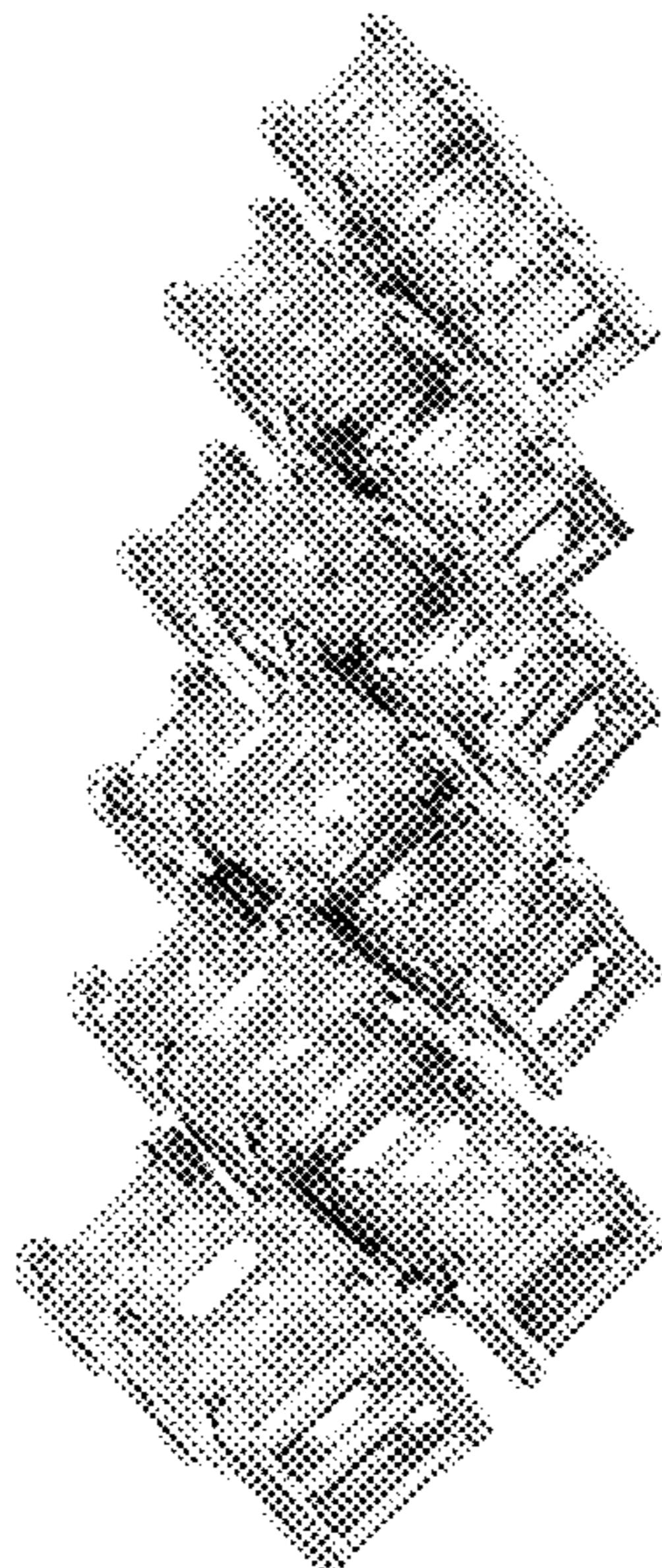

(56)

References Cited

OTHER PUBLICATIONS

Bulgaria 18k Gold Earrings, available 1979, online, site visited Sep. 25, 2021. Available from internet, URL: https://www.1stdibs.com/jewelry/earrings/clip-on-earrings/bulgari-18k-gold-earrings/id-j_13333341/ (Year: 1979).*

Rita Linear Diamond Drop Earrings, available 2021, site visited Sep. 25, 2021. Available from internet, URL: <https://www.nordstrom.com/s/bony-levy-rita-linear-diamond-drop-earrings-nordstrom-exclusive/> (Year: 2021).*

* cited by examiner

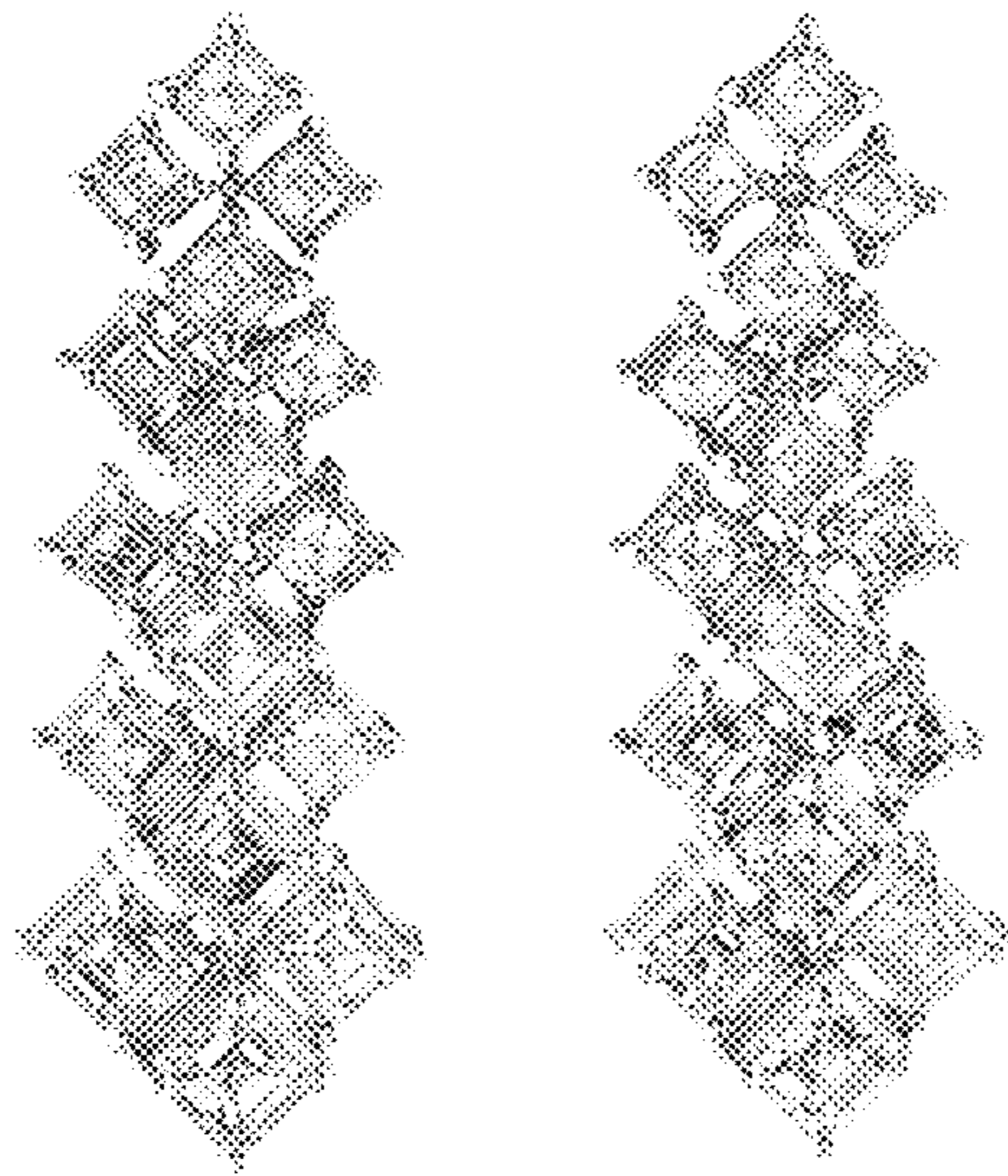

FIG. 1

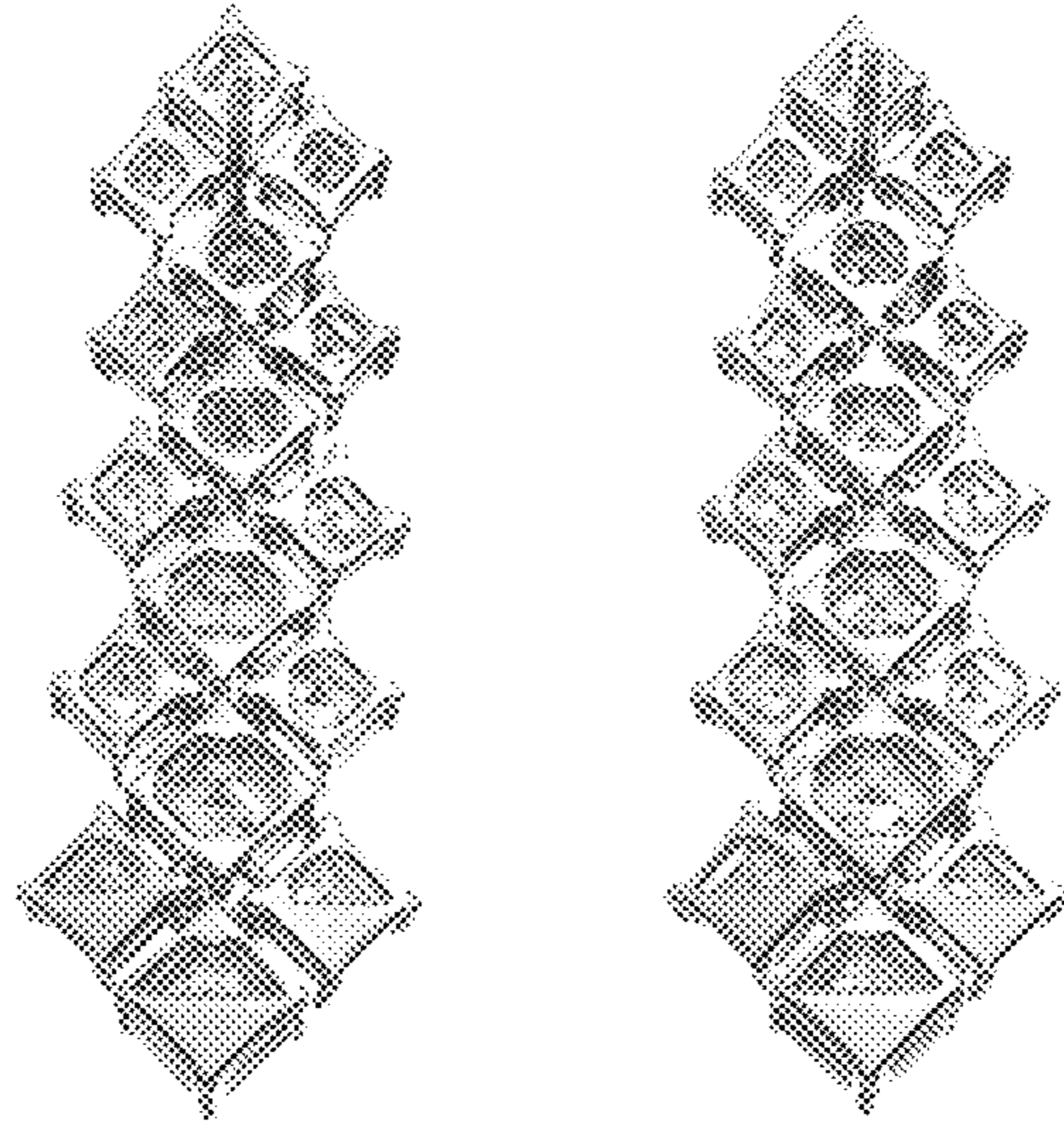

FIG. 2

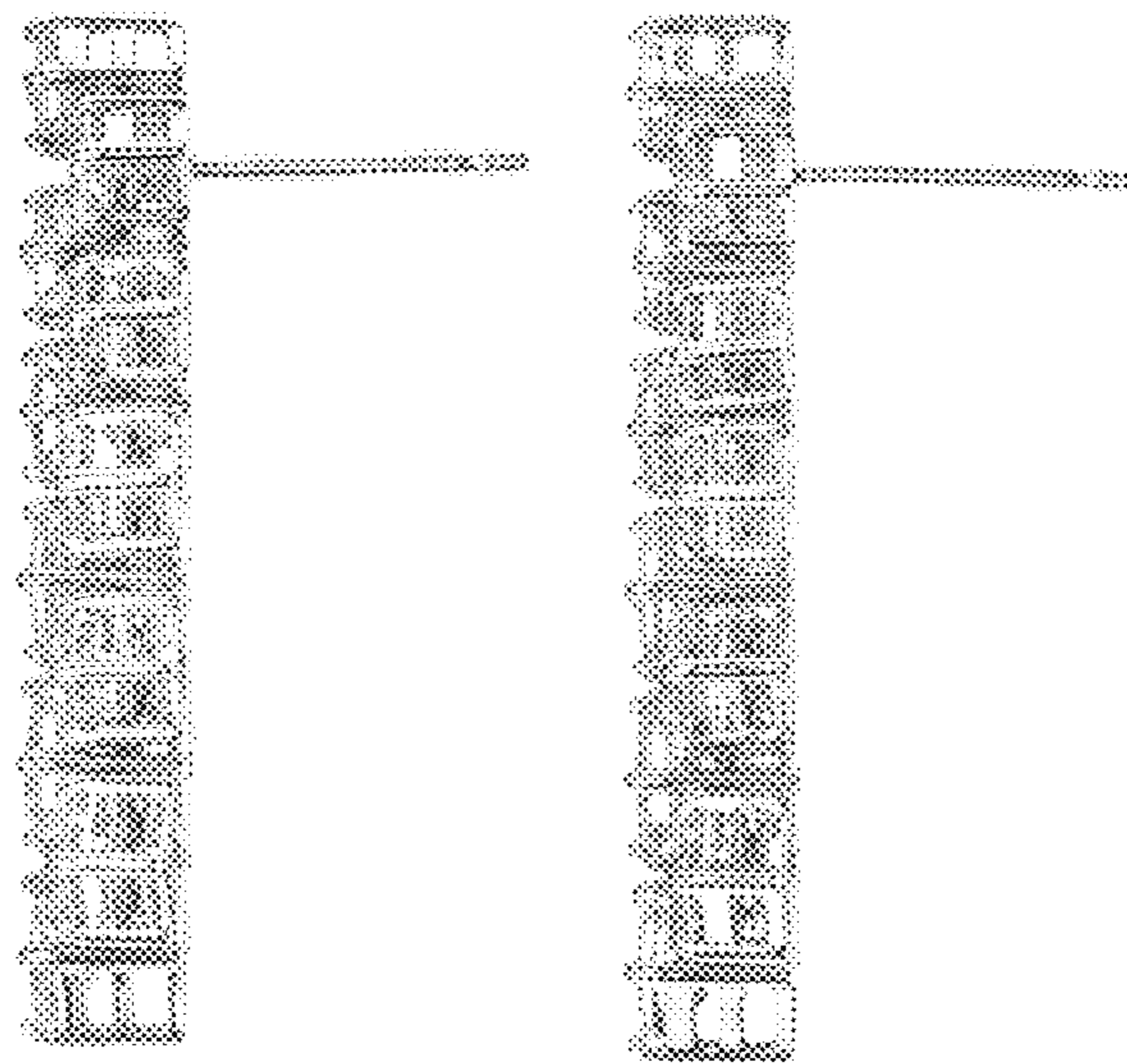

FIG. 3

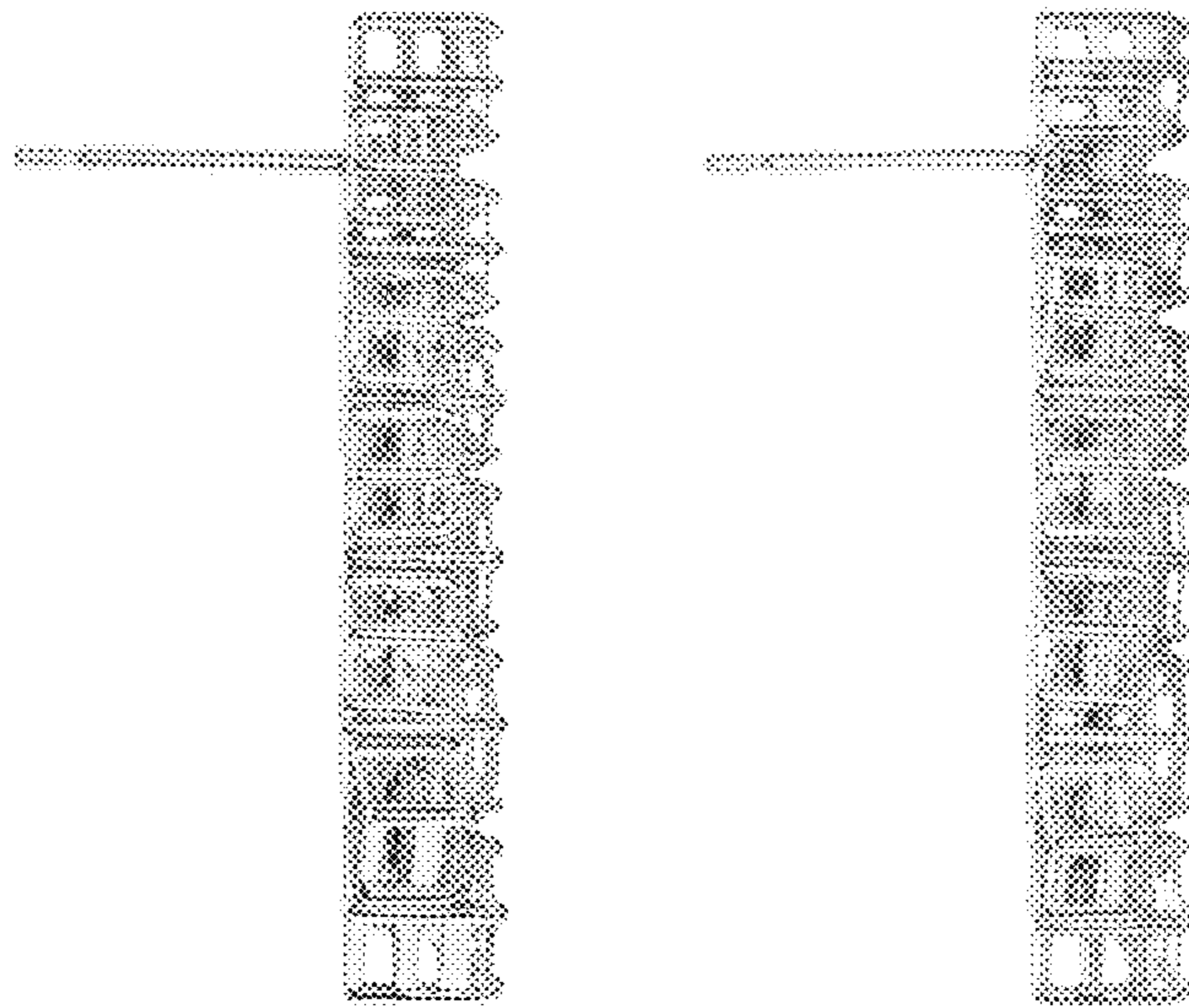

FIG. 4

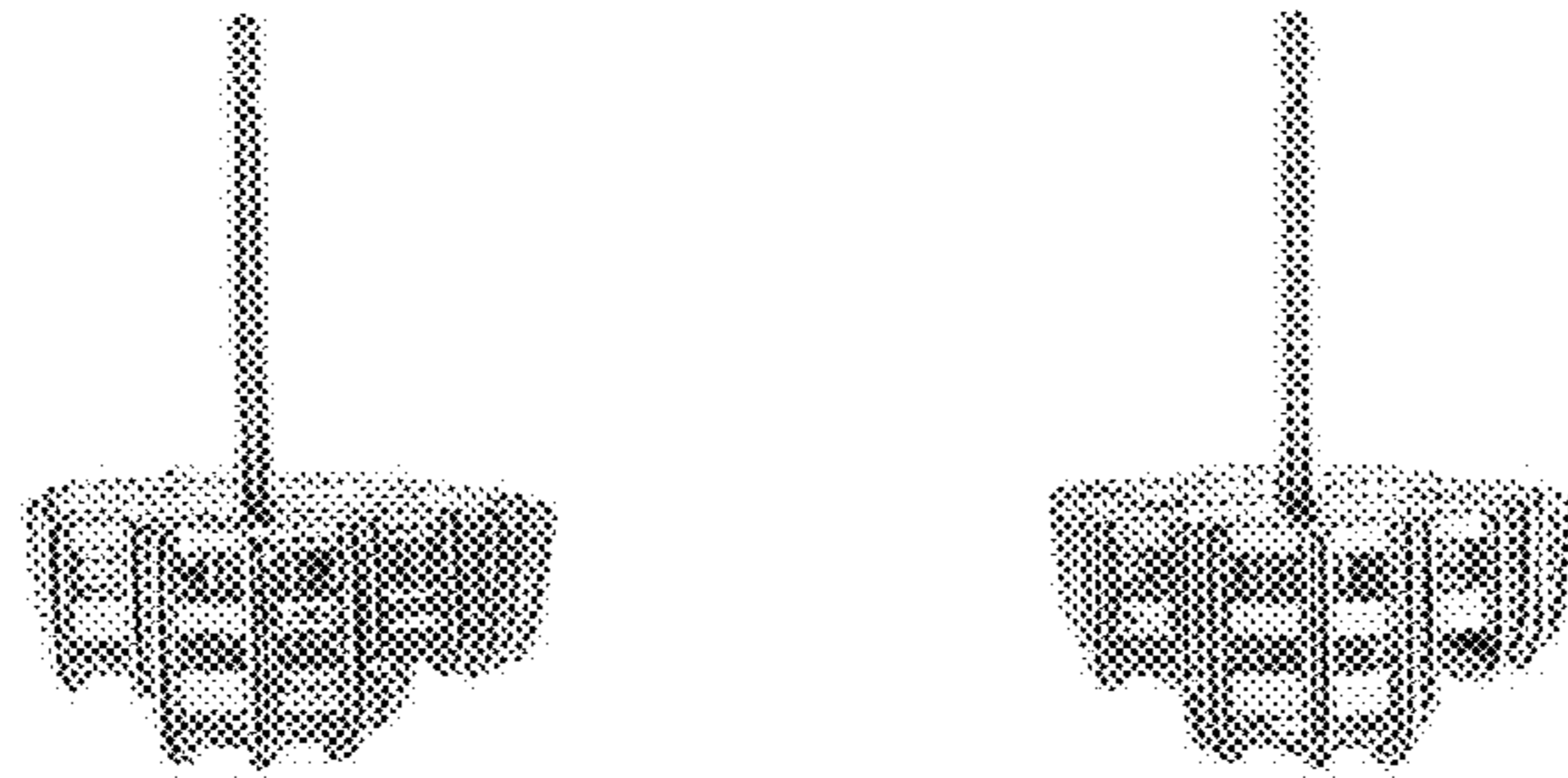

FIG. 5

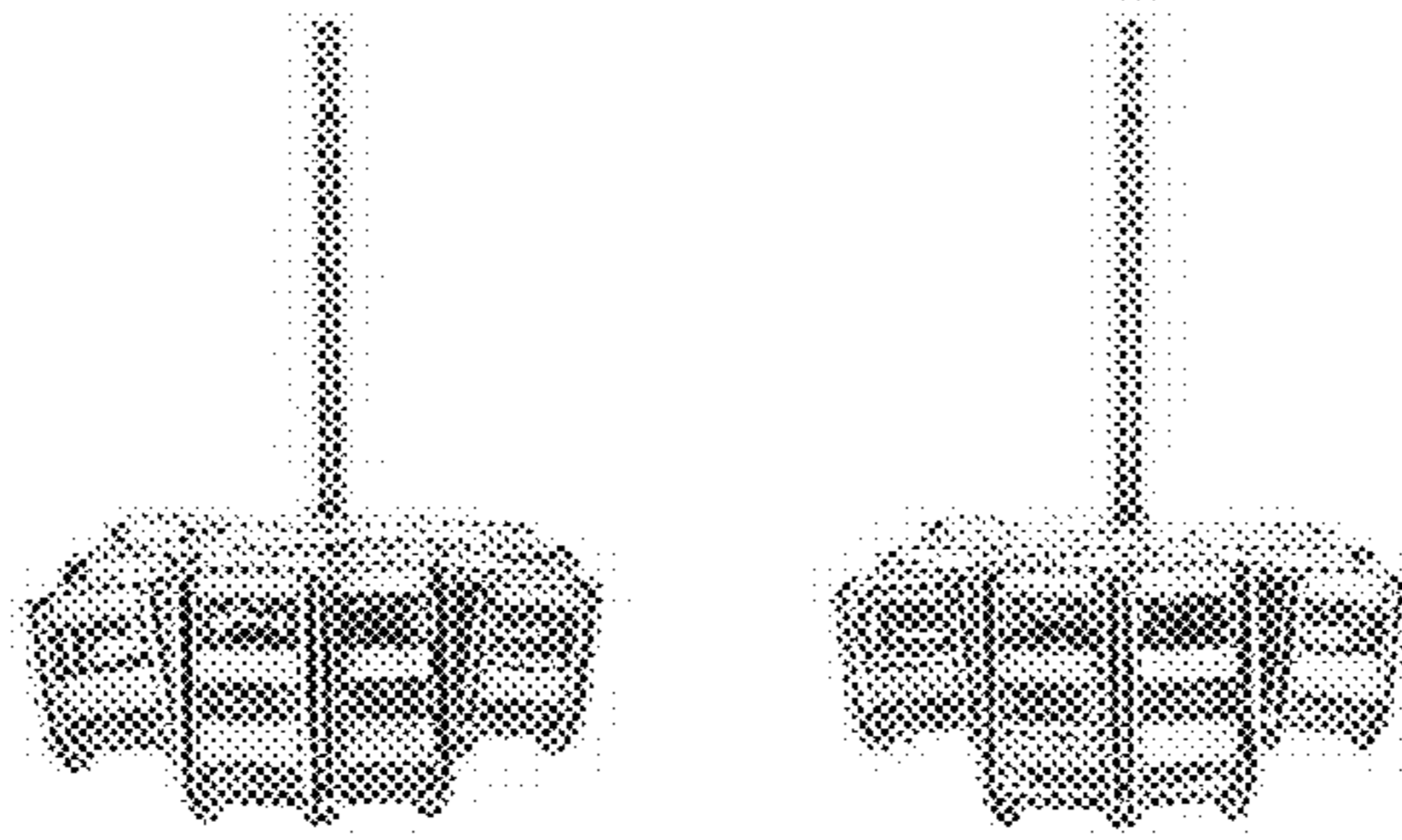

FIG. 6

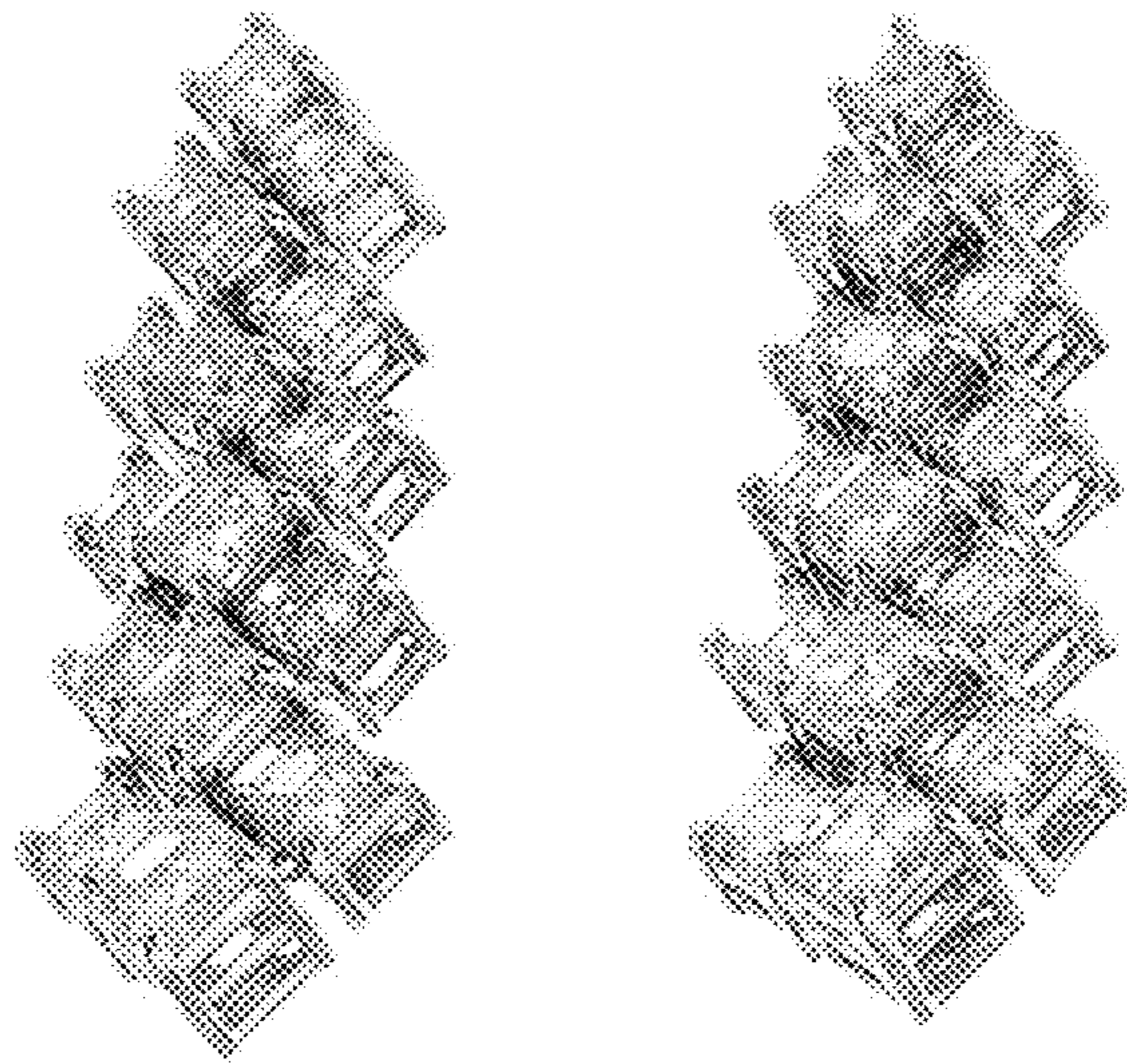

FIG. 7

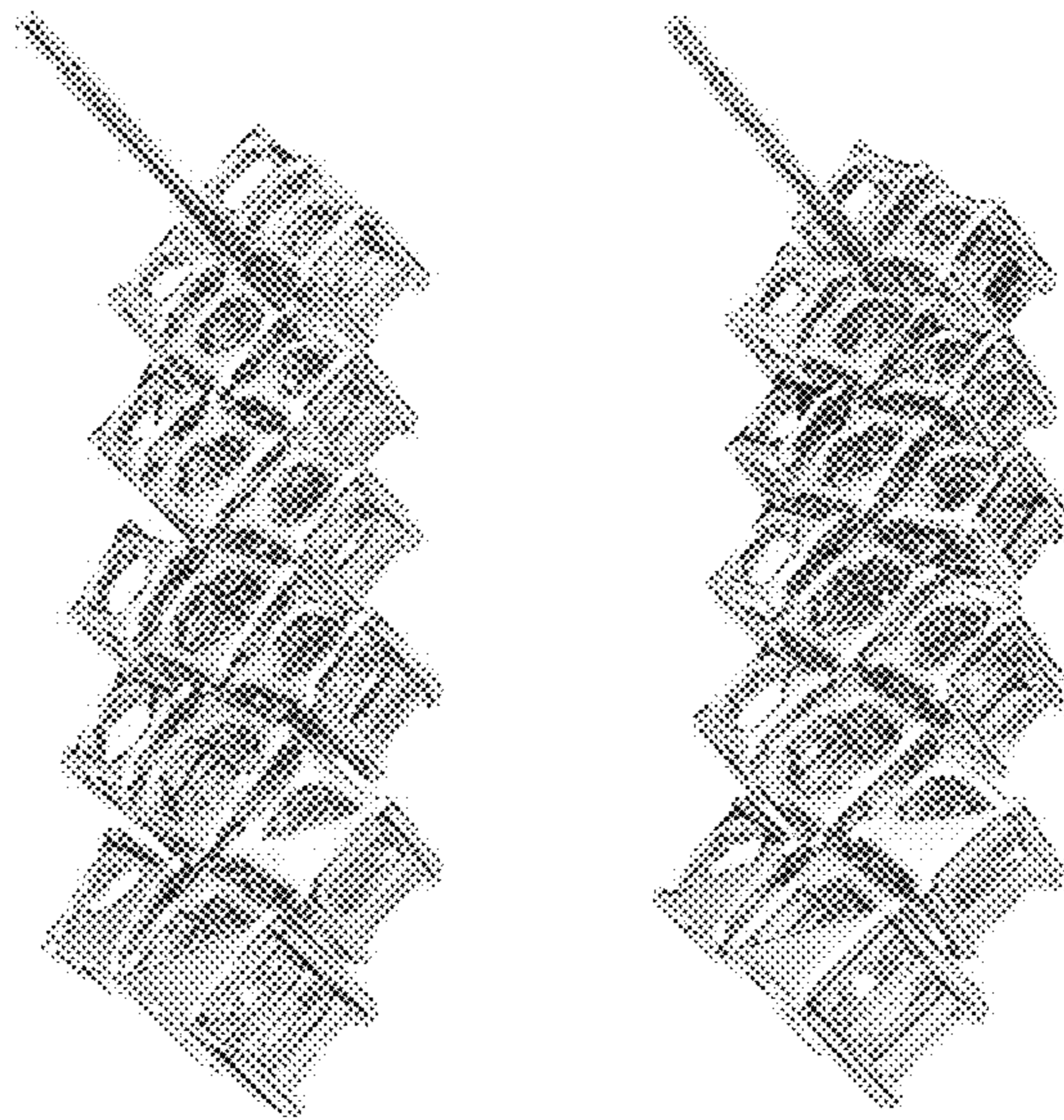

FIG. 8