



US00D942148S

(12) **United States Design Patent**  
**Zhou**

(10) **Patent No.:** **US D942,148 S**  
(45) **Date of Patent:** **\*\* Feb. 1, 2022**

(54) **DETACHABLE BRISTLE HEAD FOR ELECTRIC FACE BRUSH**

(71) Applicant: **JS Holding Inc.**, Dover, DE (US)

(72) Inventor: **Xin Zhou**, Irvine, CA (US)

(73) Assignee: **JS Holding Inc.**, Dover, DE (US)

(\*\*) Term: **15 Years**

(21) Appl. No.: **29/746,017**

(22) Filed: **Aug. 11, 2020**

(51) **LOC (13) Cl.** ..... **28-03**

(52) **U.S. Cl.**  
USPC ..... **D4/102; D4/113**

(58) **Field of Classification Search**  
USPC ..... D4/100, 102, 121, 127, 126, 128, 129,  
D4/130, 132, 133, 134, 135, 136, 138,  
(Continued)

(56) **References Cited**

**U.S. PATENT DOCUMENTS**

D46,240 S \* 8/1914 Williams ..... D24/211  
D369,026 S \* 4/1996 Furbert ..... D23/223  
(Continued)

**FOREIGN PATENT DOCUMENTS**

CN 305344403 \* 9/2019  
CN 305999556 \* 8/2020  
(Continued)

**OTHER PUBLICATIONS**

Clarisonic Mia 1 Facial Cleansing Brush System, by L'Oreal (screen-shot from video at frame 0:23 / 4:10) [on-line]. [Published Dec. 15, 2018.] [Retrieved Jul. 29, 2021.] URL: ><https://www.youtube.com/watch?v=NMz1EgrOE08> (Year: 2018).\*

*Primary Examiner* — Karen E Eldridge Powers  
(74) *Attorney, Agent, or Firm* — Fox Rothschild LLP

(57) **CLAIM**

The ornamental design of a detachable bristle head for electric face brush, as shown and described.

**DESCRIPTION**

FIG. 1 illustrates a top plan view of a first embodiment of a detachable bristle head for electric face brush.  
FIG. 2 illustrates a top, front perspective view of the first embodiment of the bristle head;  
FIG. 3 illustrates a front elevation view of the first embodiment of the bristle head.  
FIG. 4 illustrates a rear elevation view of first embodiment of the bristle head.  
FIG. 5 illustrates a side elevation view of the first embodiment of the bristle head.  
FIG. 6 illustrates an opposite side elevation view of the first embodiment of the bristle head.  
FIG. 7 illustrates a bottom plan view of the first embodiment of the bristle head.  
FIG. 8 illustrates a top plan view of a second embodiment of a detachable bristle head for electric face brush.  
FIG. 9 illustrates a top, front perspective view of the second embodiment of the bristle head;  
FIG. 10 illustrates a front elevation view of the second embodiment of the bristle head.  
FIG. 11 illustrates a rear elevation view of second embodiment of the bristle head.  
FIG. 12 illustrates a side elevation view of the second embodiment of the bristle head.  
FIG. 13 illustrates an opposite side elevation view of the second embodiment of the bristle head; and,  
FIG. 14 illustrates a bottom plan view of the second embodiment of the bristle head.  
In each of the Figures, broken lines show elements that form no part of the claimed design.

**1 Claim, 10 Drawing Sheets**

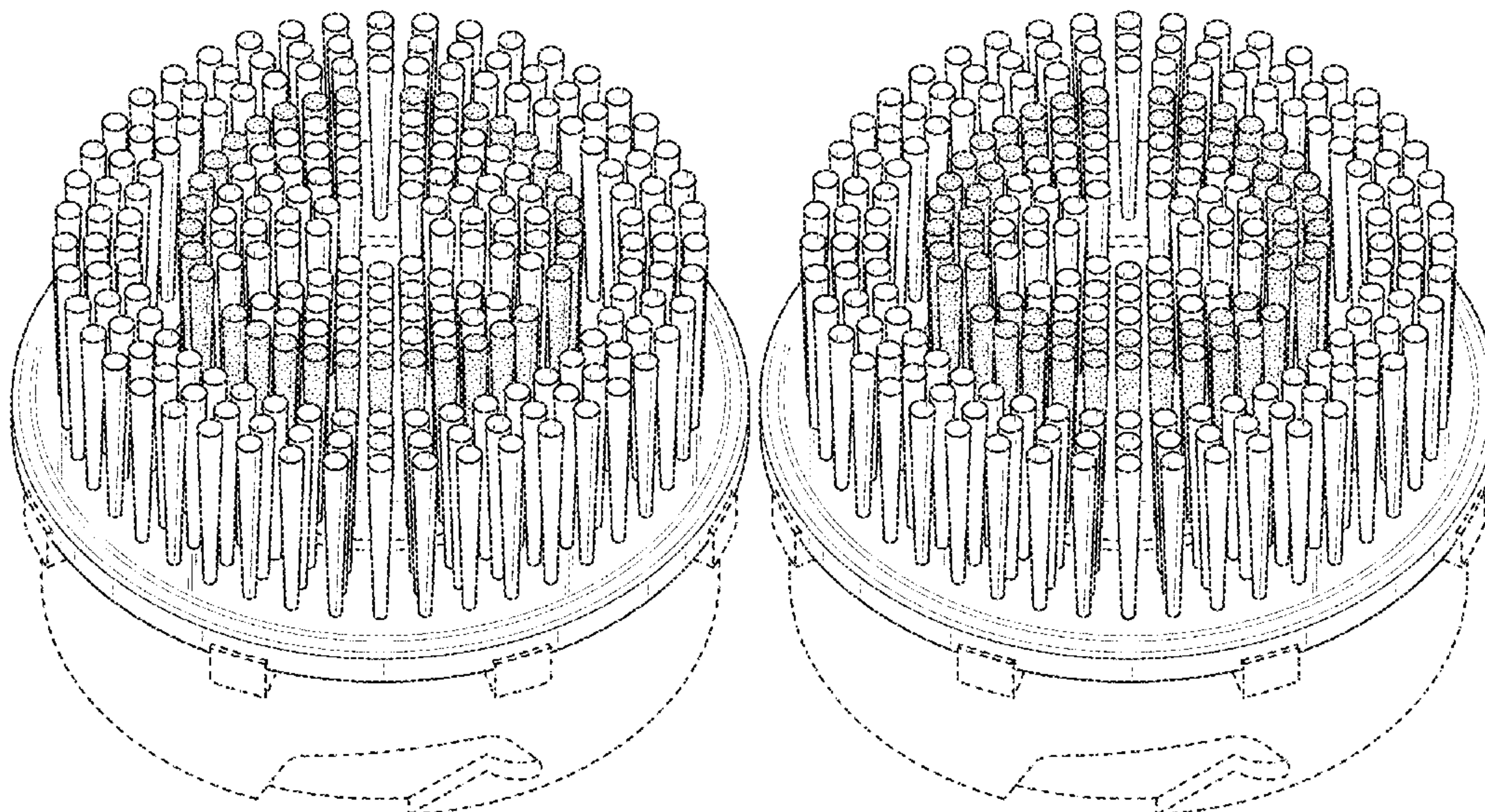

(58) **Field of Classification Search**

USPC ..... D4/199; D24/211, 214, 215; D30/158,  
 D30/159, 160; D32/35  
 CPC ..... A46B 2200/1006; A46B 2200/102; A46B  
 2200/10  
 See application file for complete search history.

(56) **References Cited**

U.S. PATENT DOCUMENTS

D549,964 S 9/2007 Roth et al.  
 7,386,906 B2 6/2008 Roth et al.  
 D589,257 S \* 3/2009 Van Wambeke ..... D4/102  
 D601,803 S 10/2009 Reishus et al.  
 D683,139 S 5/2013 Chikos et al.  
 8,484,788 B2 7/2013 Brewer et al.  
 D715,554 S 10/2014 Hosler et al.  
 D715,555 S 10/2014 Hosler et al.  
 D715,556 S 10/2014 Brewer  
 D715,557 S 10/2014 Brewer et al.  
 D715,558 S 10/2014 Brewer  
 9,107,486 B2 \* 8/2015 Brewer ..... A46B 13/02  
 D768,391 S \* 10/2016 Kling ..... D4/127  
 9,642,768 B2 \* 5/2017 Ungemach ..... A61H 23/0254  
 9,706,832 B2 \* 7/2017 Price ..... A46B 11/0089

9,801,448 B1 \* 10/2017 Jakubow ..... A45D 27/06  
 D804,826 S \* 12/2017 Kling ..... D4/127  
 9,889,282 B2 \* 2/2018 Ungemach ..... A46B 9/028  
 D830,700 S \* 10/2018 Xue ..... D4/102  
 10,194,742 B2 \* 2/2019 Meginniss, III ..... A46B 5/0012  
 D861,908 S \* 10/2019 Gan ..... D24/214  
 D871,770 S \* 1/2020 Diener ..... D4/102  
 D871,771 S \* 1/2020 Diener ..... D4/102  
 10,531,729 B1 \* 1/2020 Liu ..... A46B 5/0095  
 D884,355 S \* 5/2020 Diener ..... D4/102  
 D889,133 S \* 7/2020 Rybacek ..... D4/116  
 D889,850 S \* 7/2020 Rybacek ..... D4/116  
 D896,530 S \* 9/2020 Diener ..... D4/102  
 2013/0023901 A1 \* 1/2013 Sanchez-Martinez .....  
 A46B 13/02  
 606/133  
 2015/0141884 A1 5/2015 Thiebaut et al.  
 2016/0121108 A1 \* 5/2016 Kondo ..... A61N 1/328  
 601/2

FOREIGN PATENT DOCUMENTS

CN 306055713 \* 9/2020  
 CN 306184610 \* 11/2020

\* cited by examiner



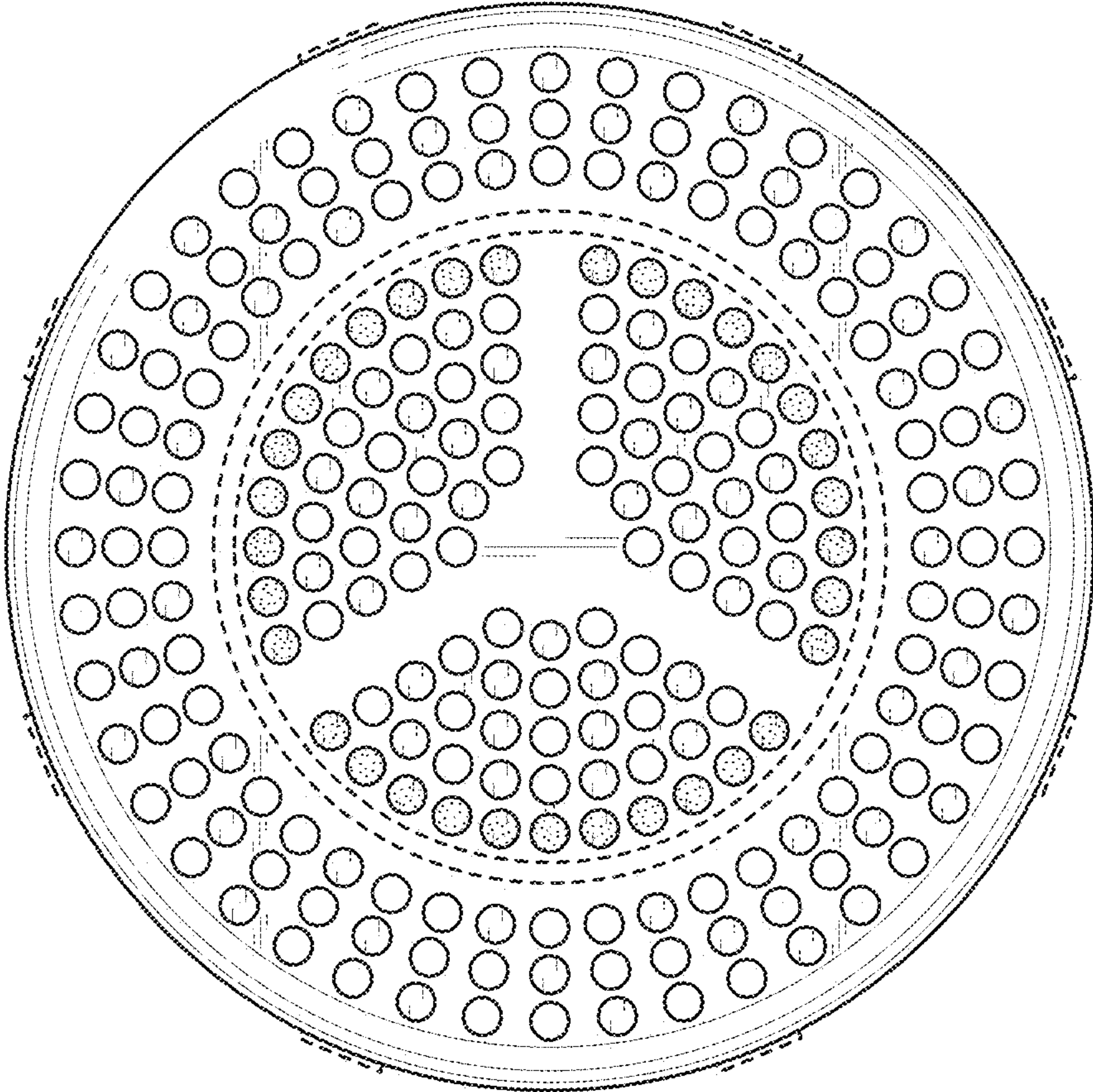

FIG. 1

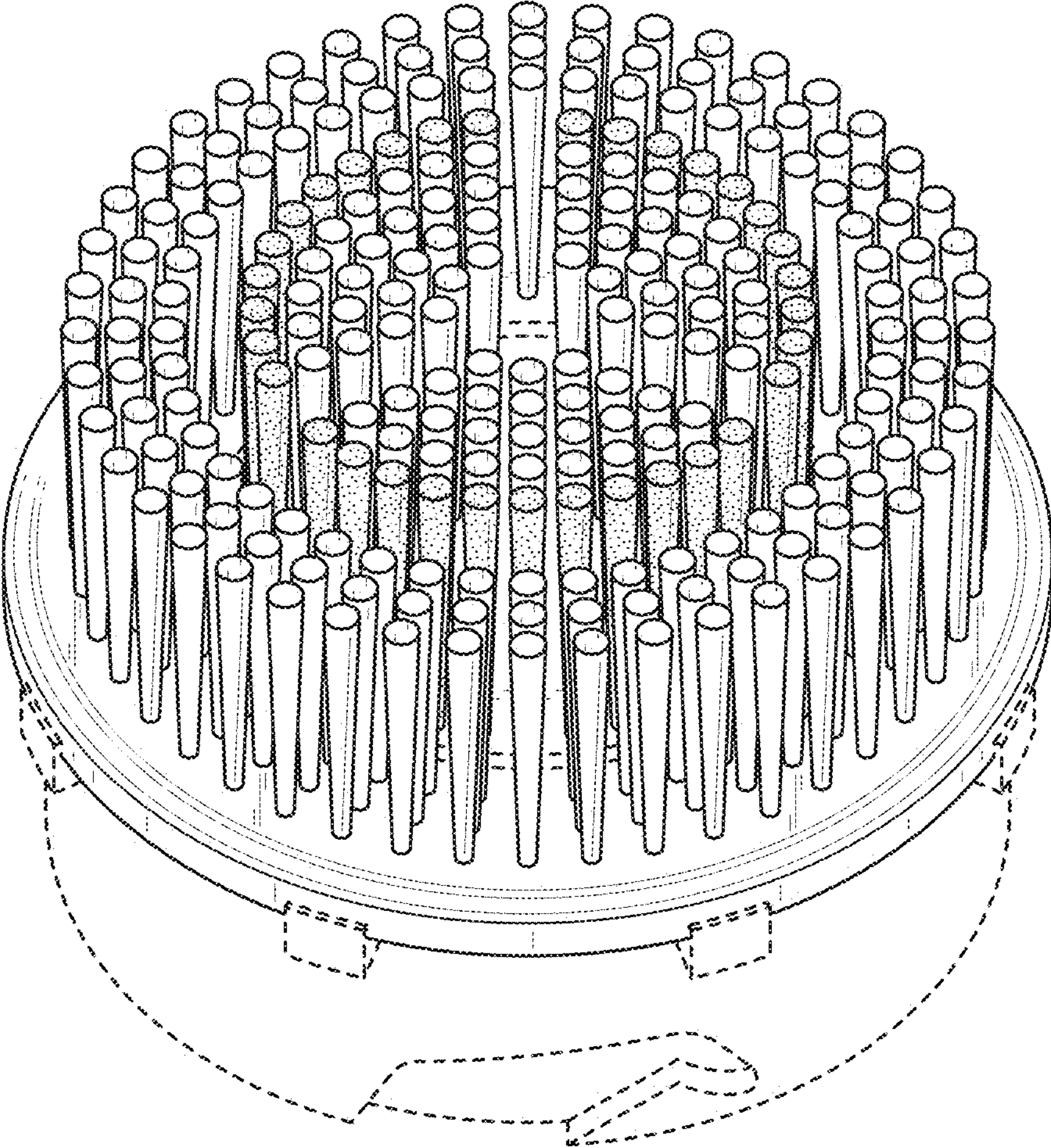

FIG. 2

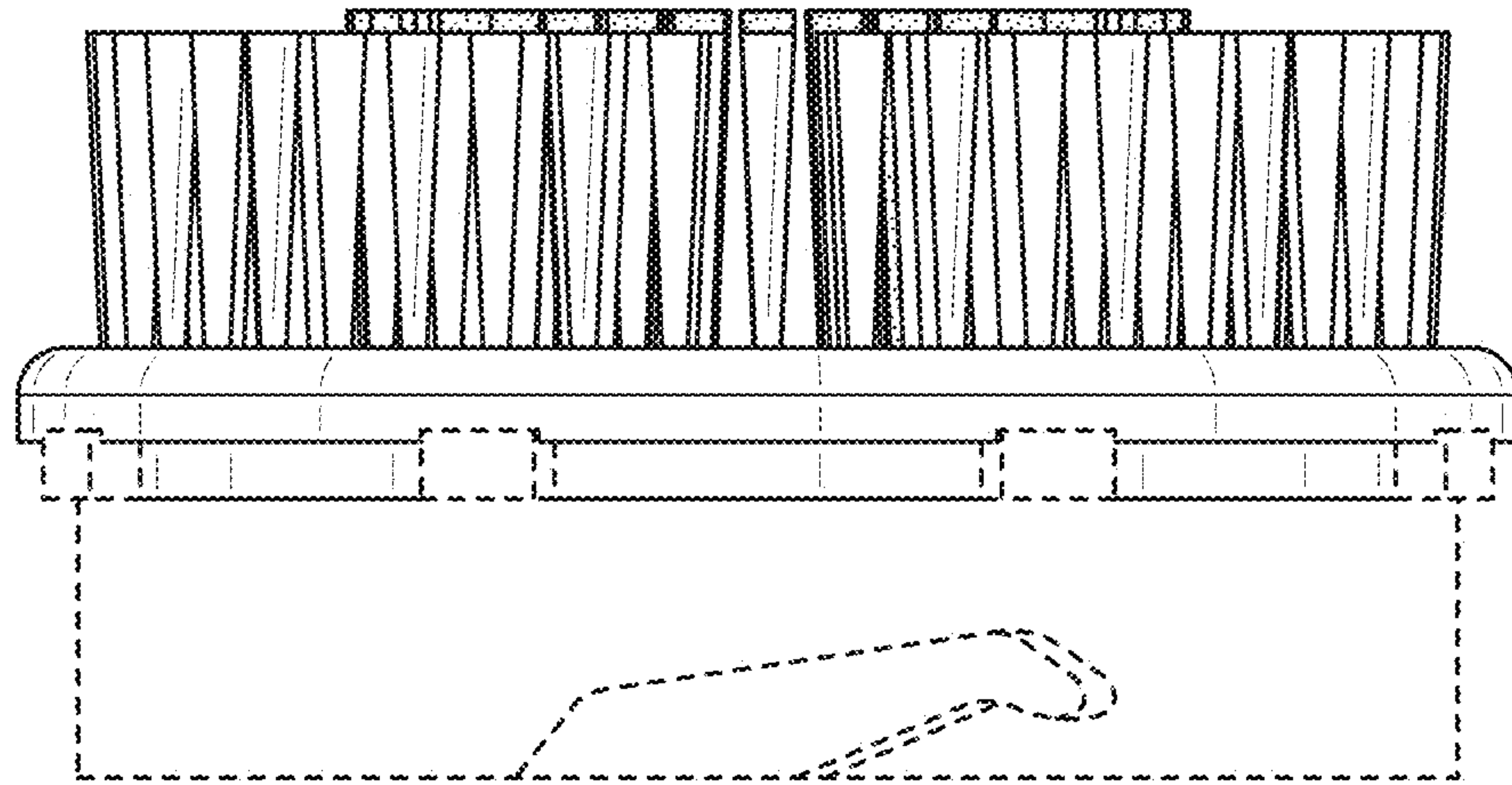

FIG. 3

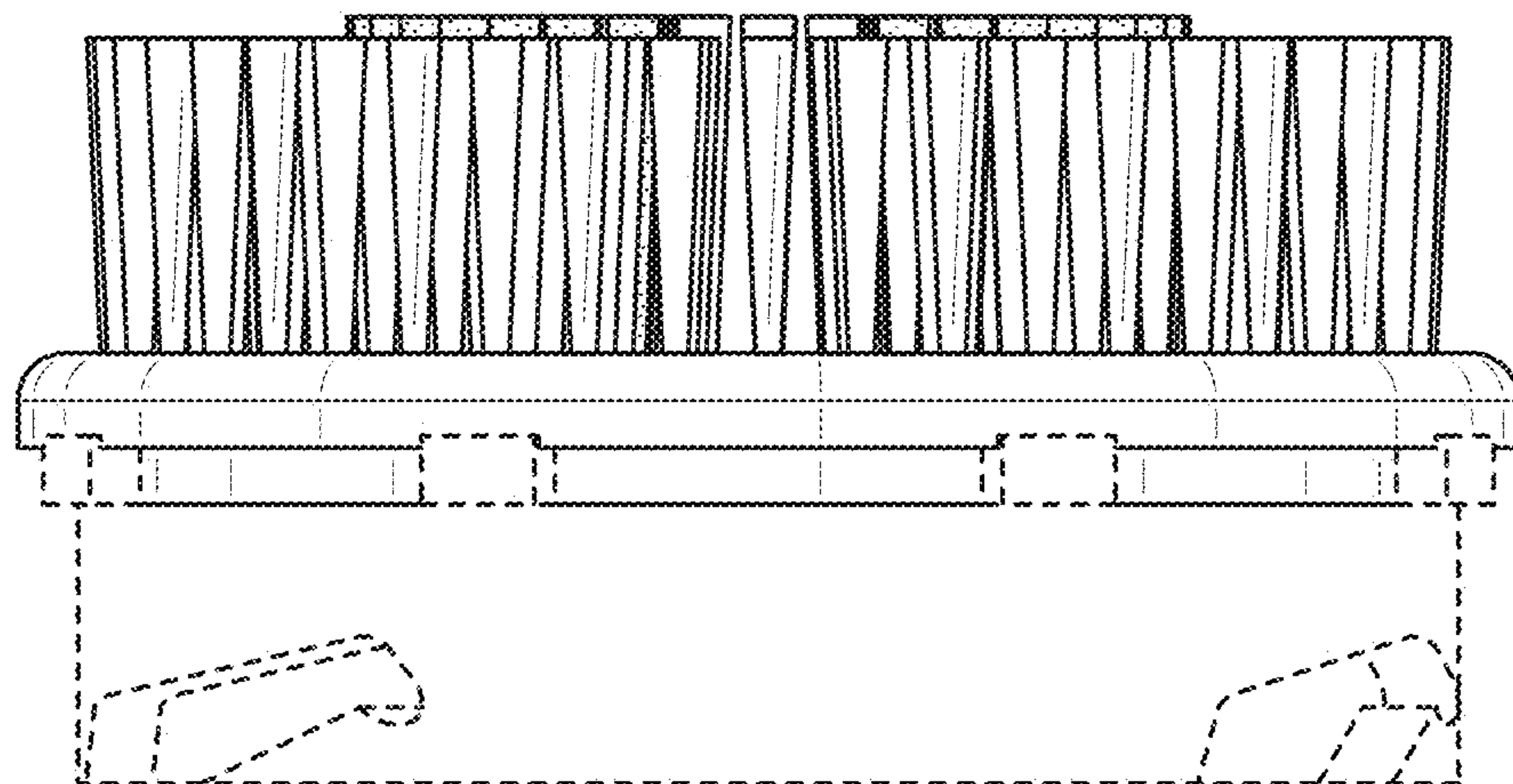

FIG. 4



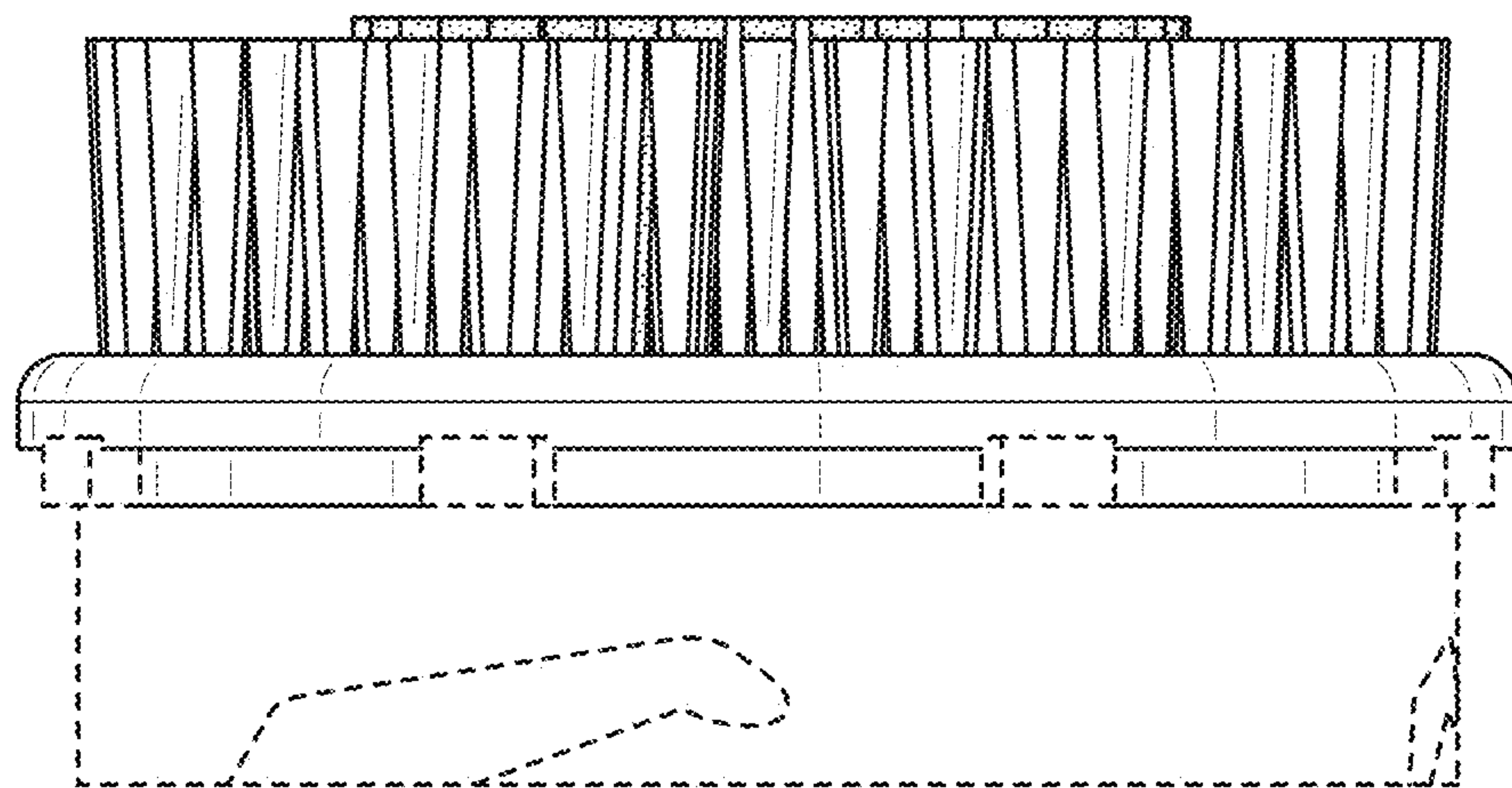

FIG. 5

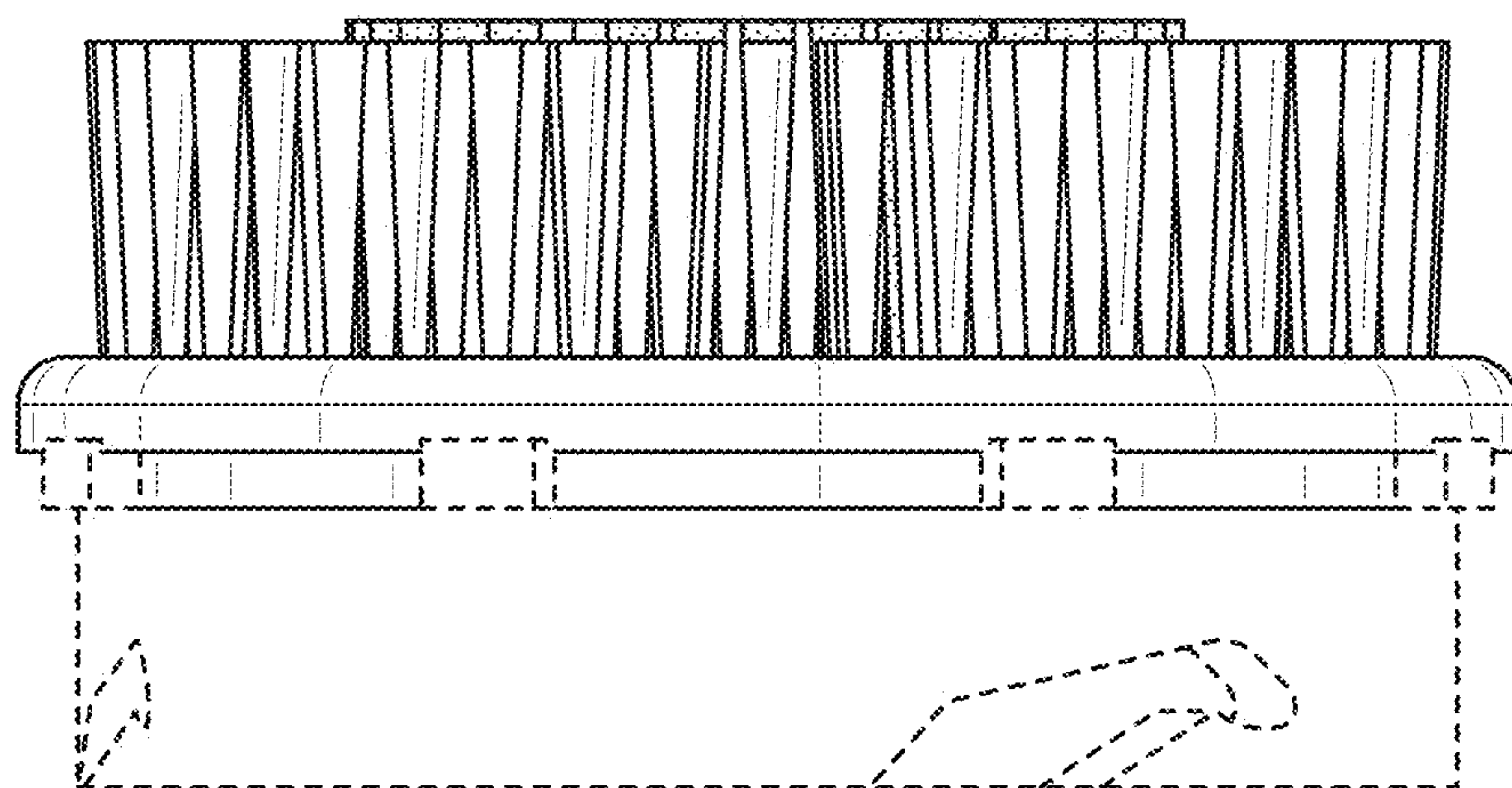

FIG. 6

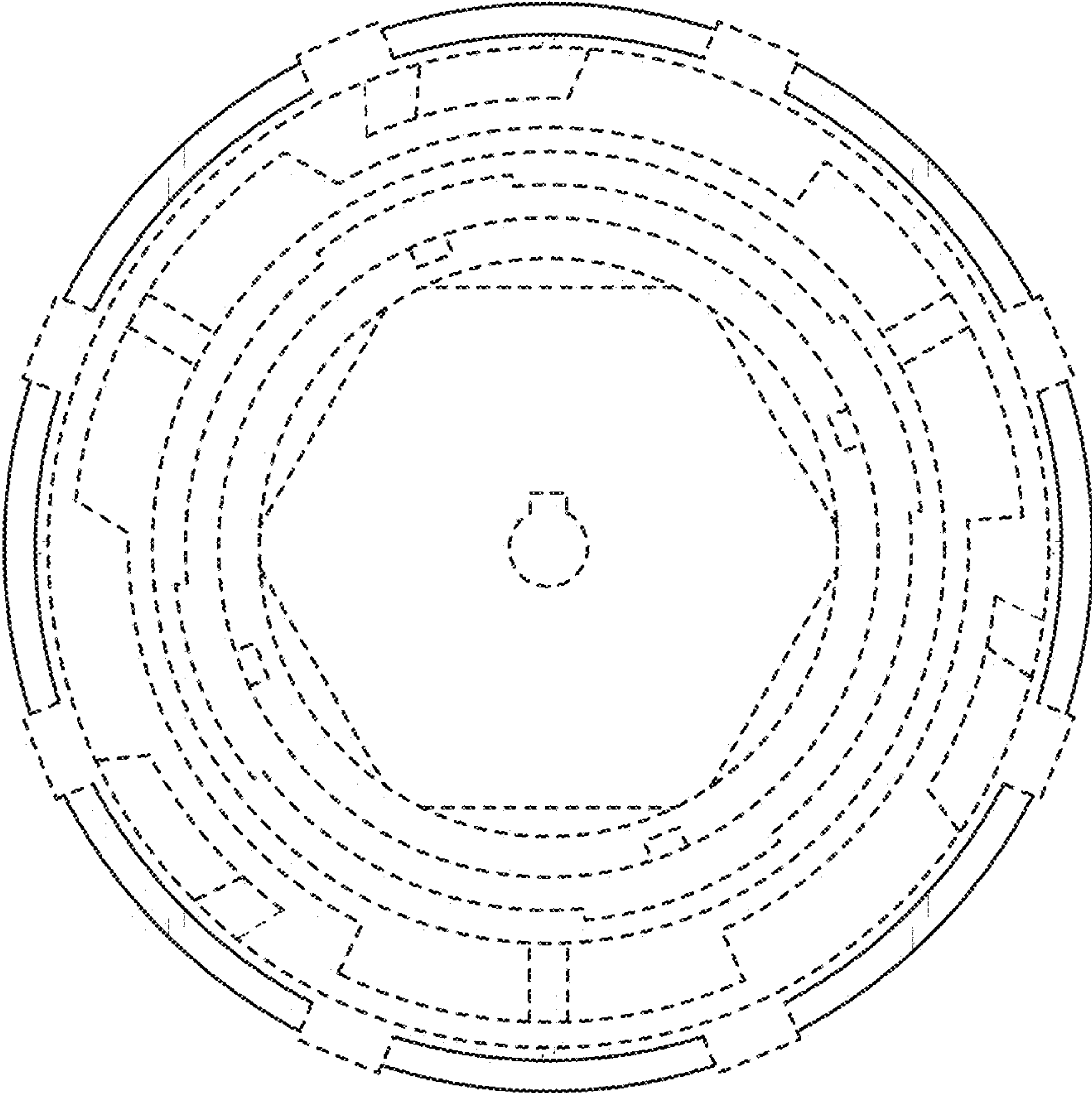

FIG. 7

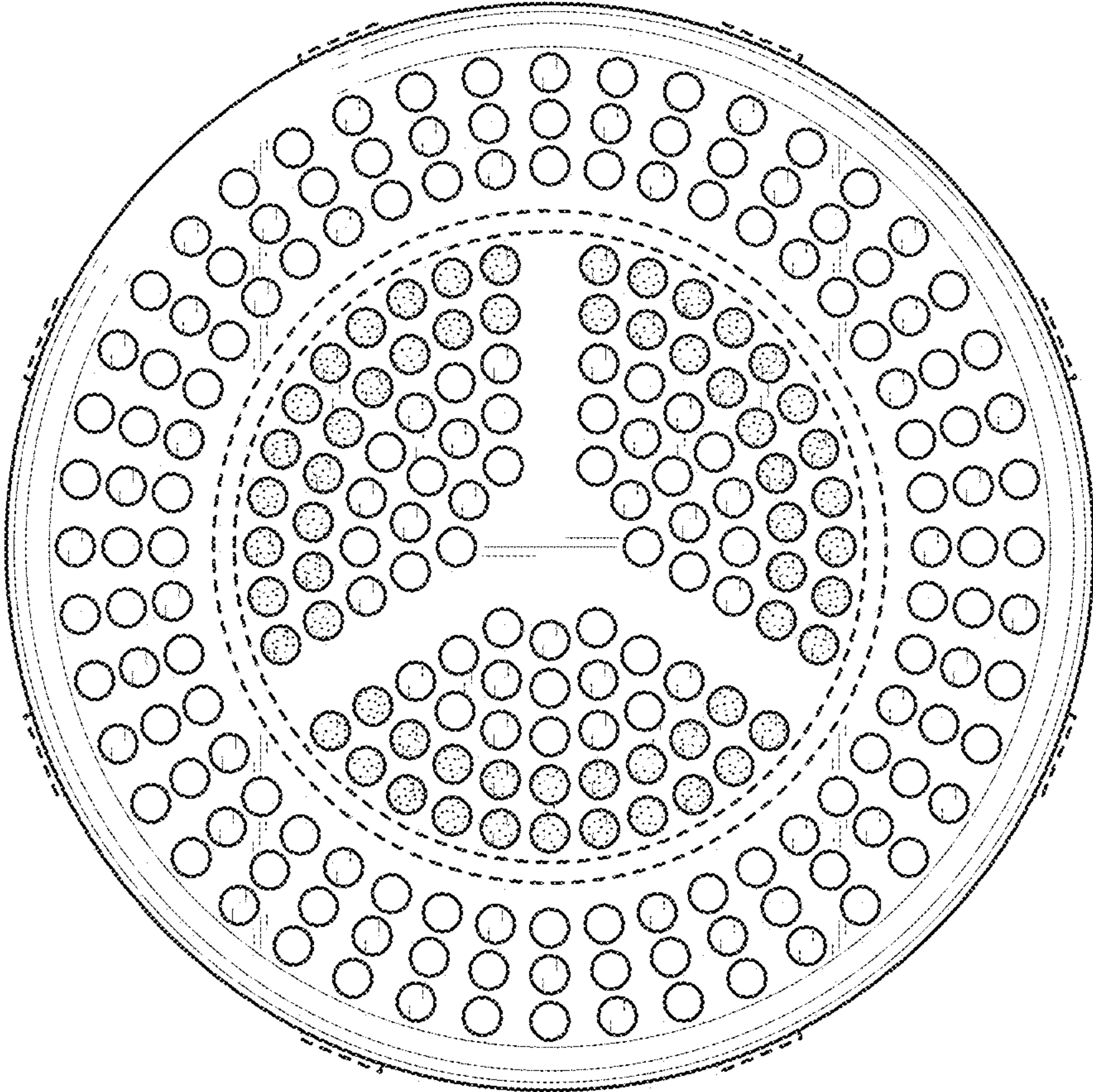

FIG. 8



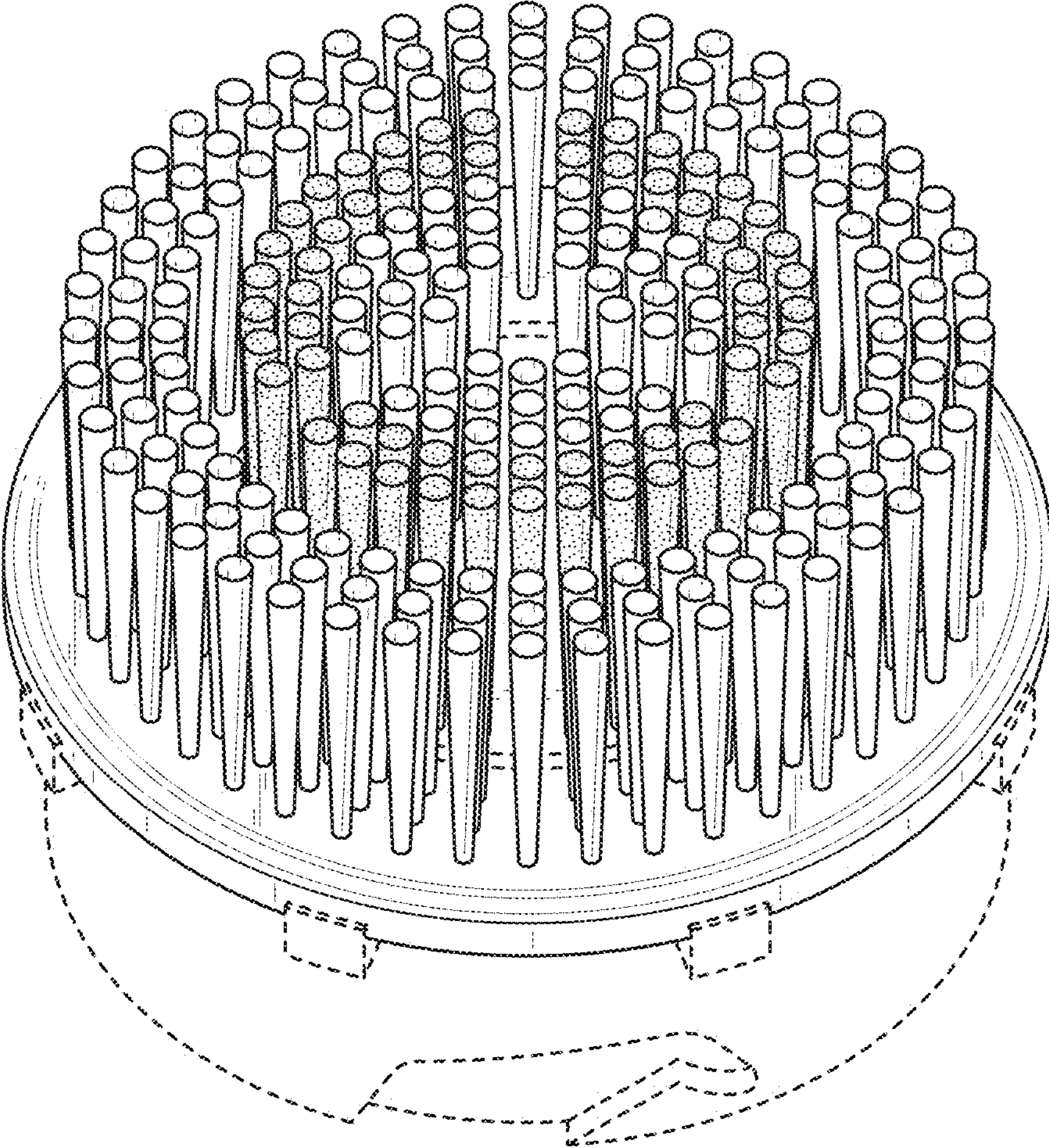

FIG. 9

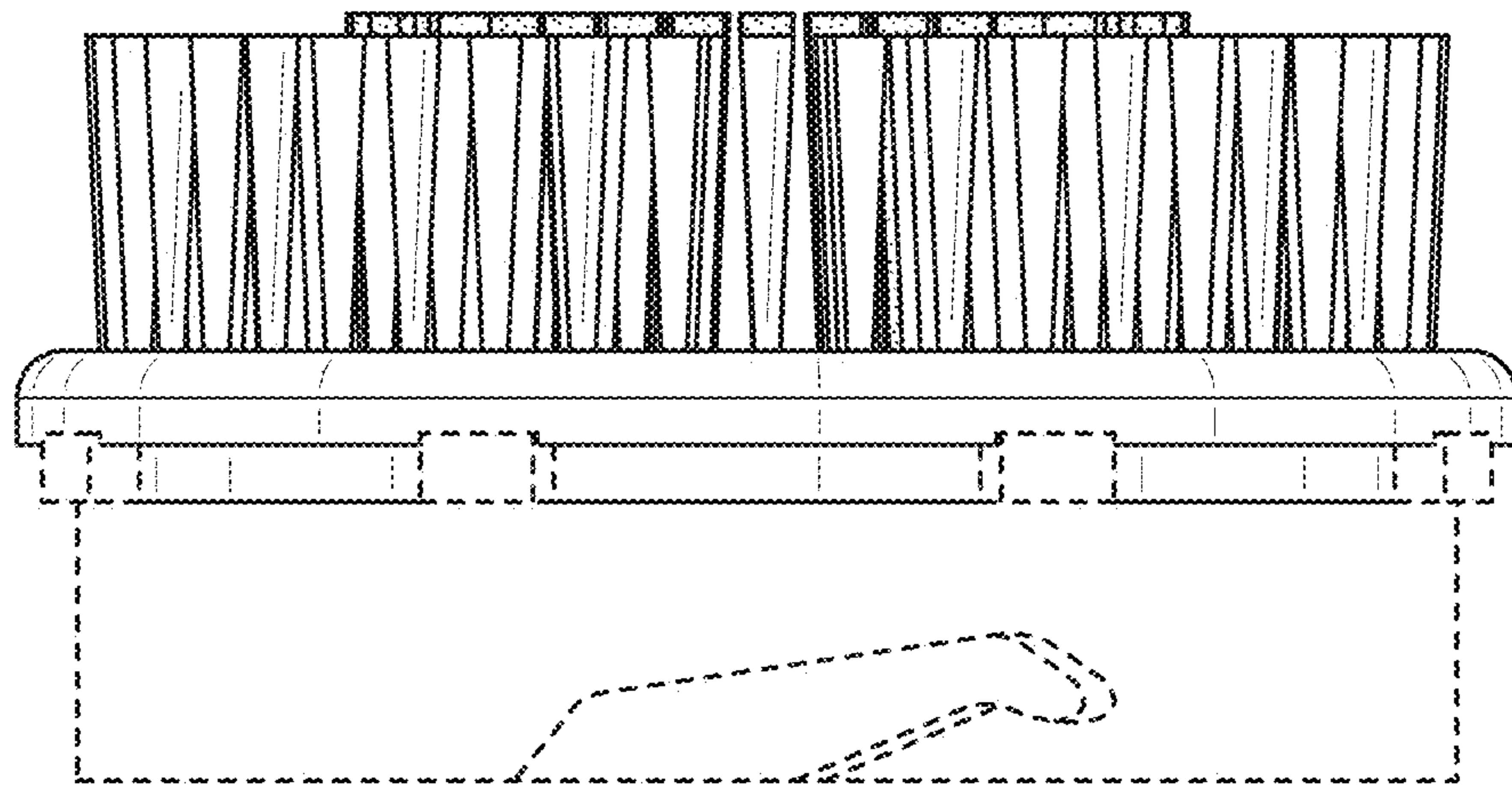

FIG. 10

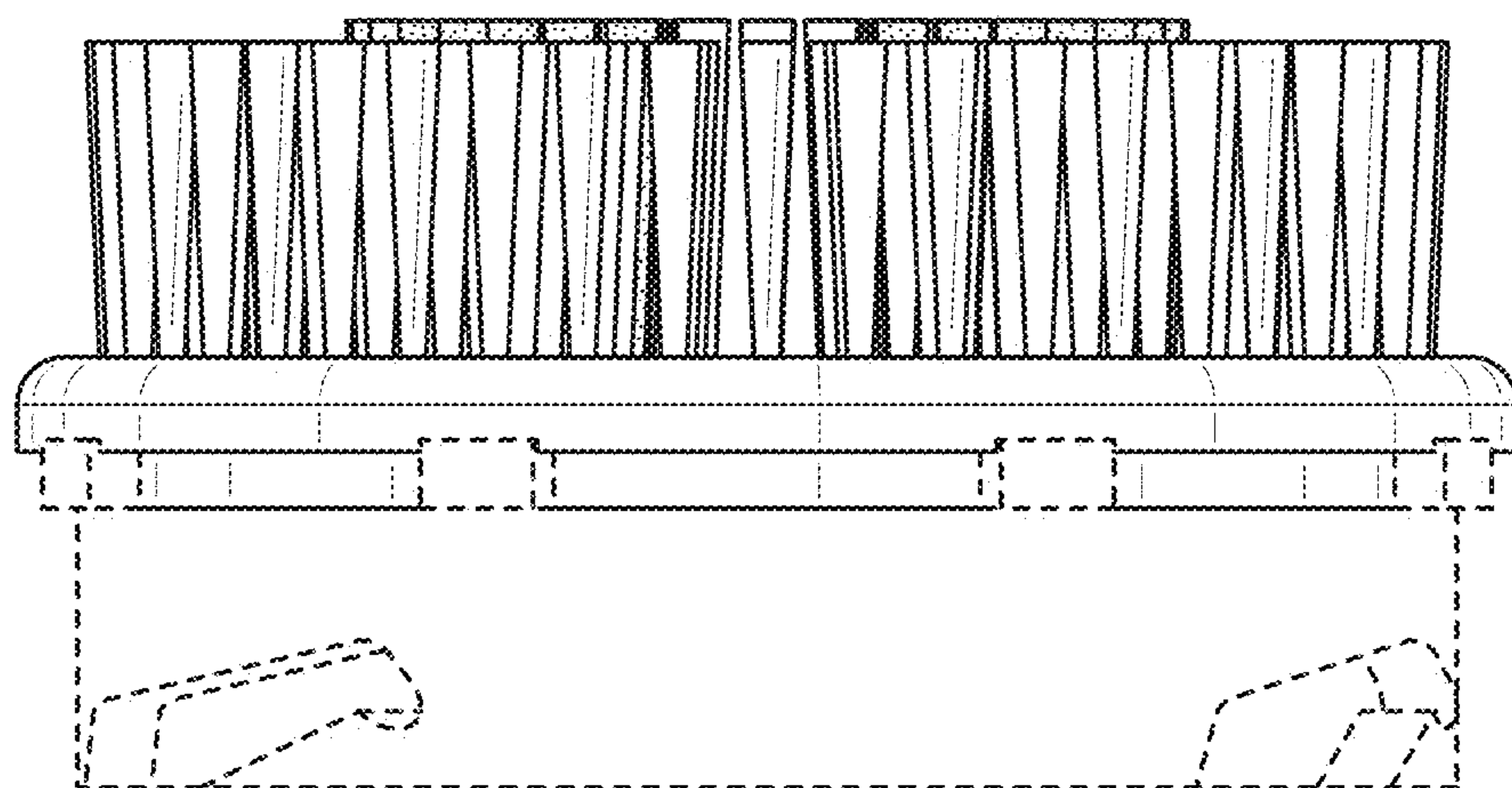

FIG. 11

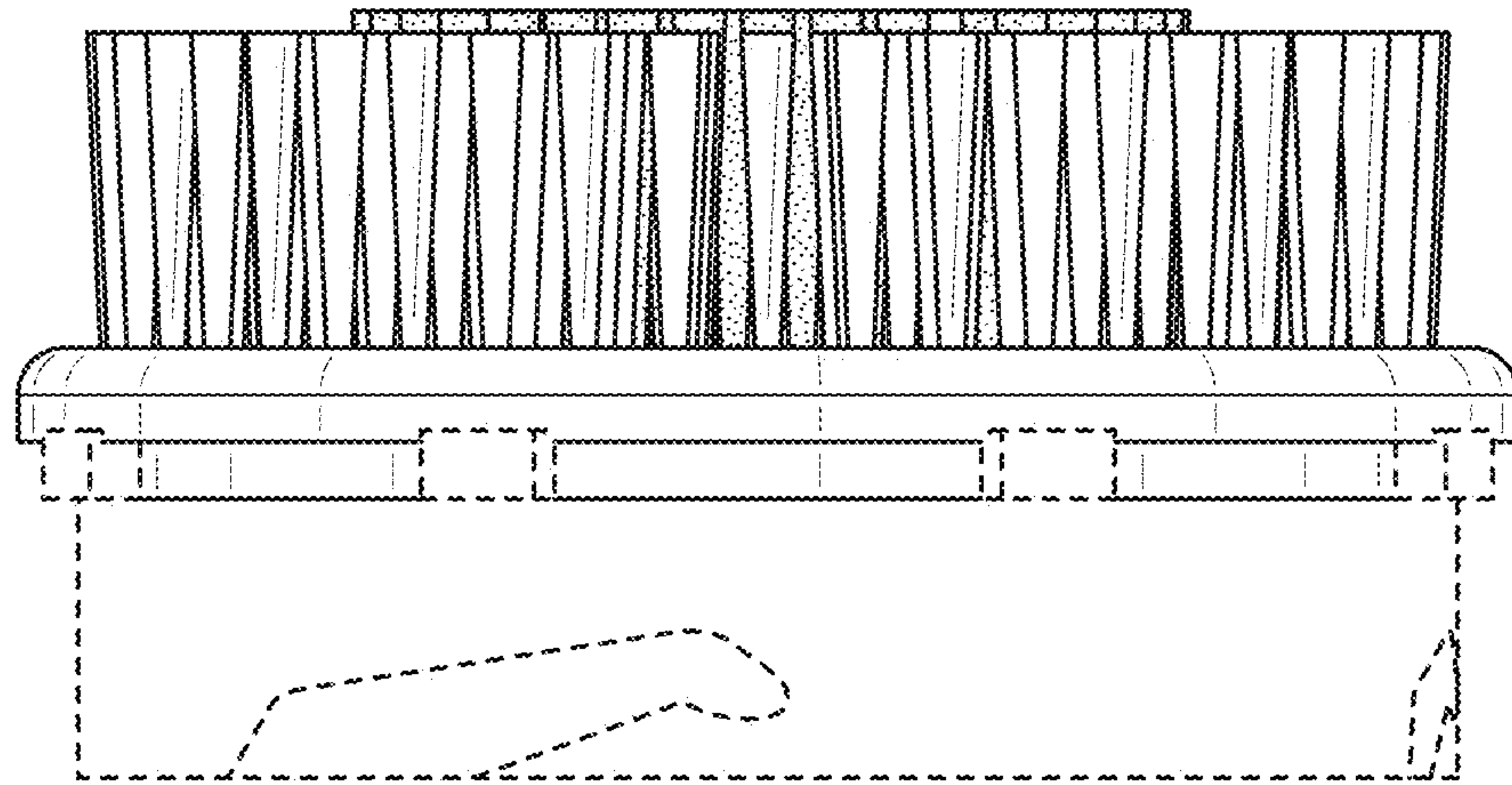

FIG. 12

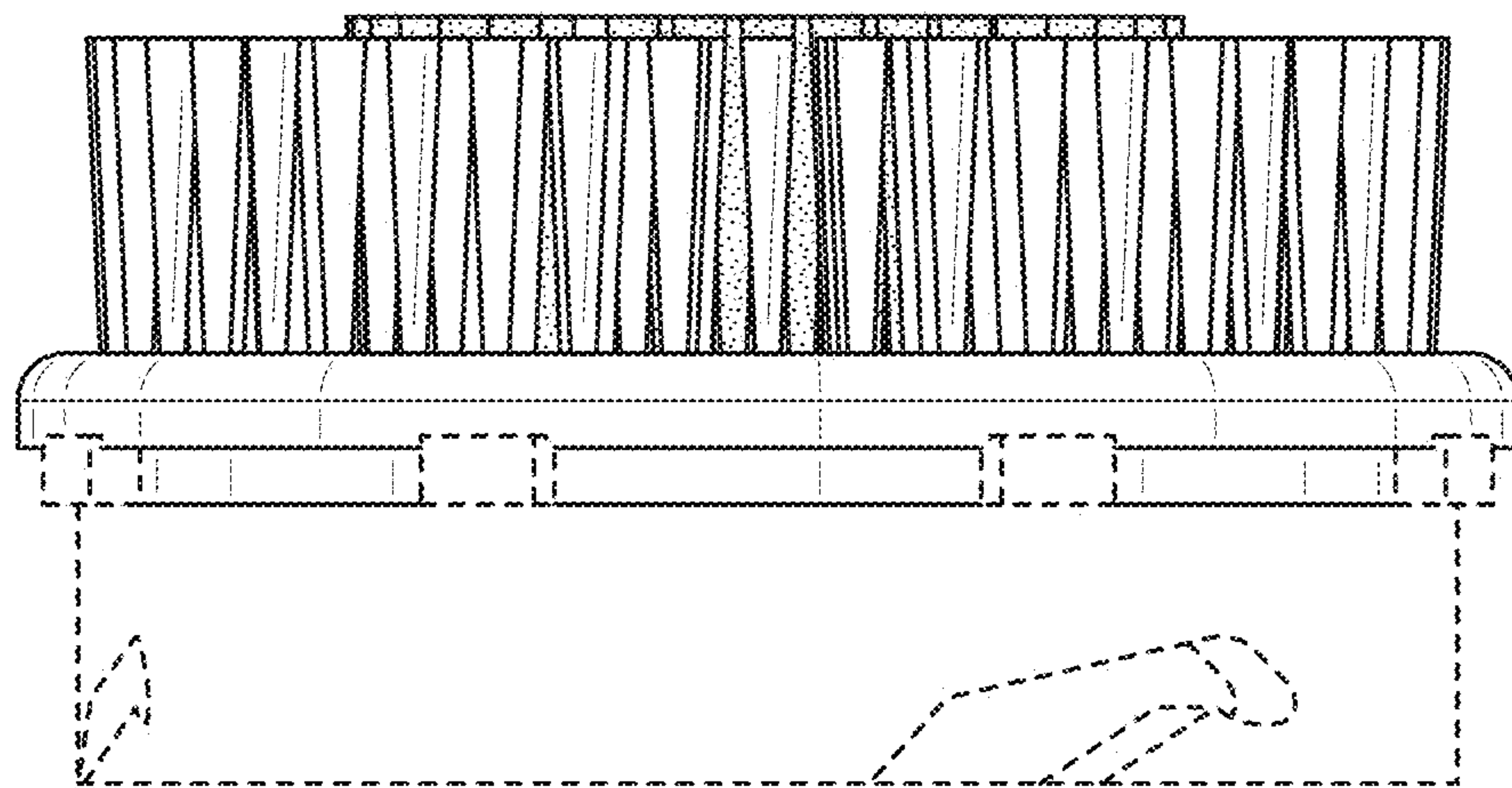

FIG. 13



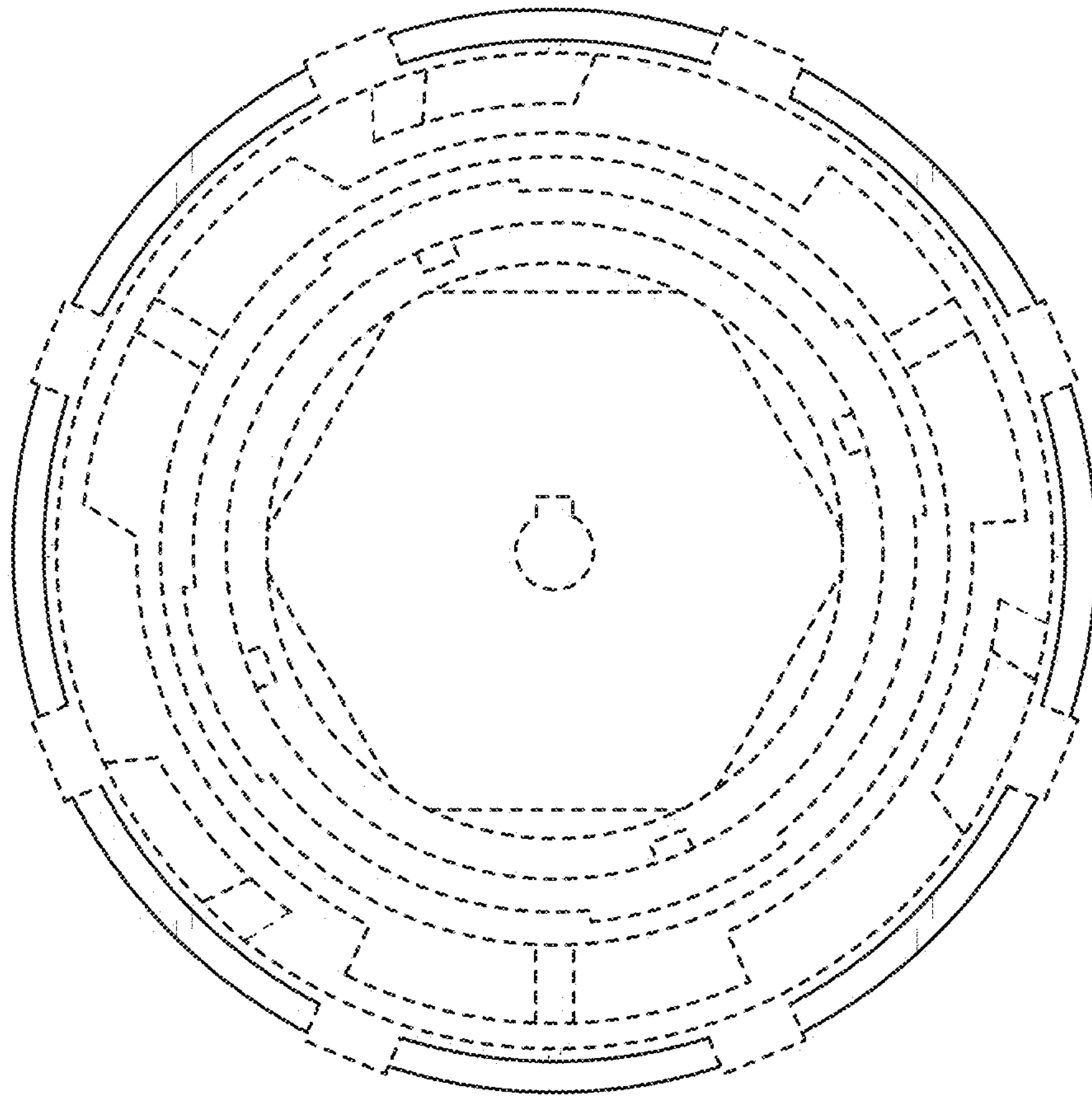

FIG. 14