

US00D942110S

(12) **United States Design Patent** (10) **Patent No.:** **US D942,110 S**
Lee et al. (45) **Date of Patent:** **** Jan. 25, 2022**

(54) **AUTOMATED TELLER MACHINE**

(56) **References Cited**

(71) Applicant: **HYOSUNG TNS INC.**, Seoul (KR)

U.S. PATENT DOCUMENTS

(72) Inventors: **Hee Youn Lee**, Gyeonggi-do (KR); **Jae Min Cha**, Gyeonggi-do (KR); **Jae Min Park**, Gyeonggi-do (KR)

D283,746 S * 5/1986 Kobayashi D99/28
D303,448 S * 9/1989 Noda D99/28
D304,642 S * 11/1989 Kakiuchi D99/28
D319,135 S * 8/1991 'Feger D99/28
D360,735 S * 7/1995 Hall D99/28
D360,739 S * 7/1995 Hall D99/28

(73) Assignee: **HYOSUNG TNS INC.**, Seoul (KR)

(Continued)

(**) Term: **15 Years**

OTHER PUBLICATIONS

(21) Appl. No.: **29/692,585**

Financial ATMS (MX5600T, MX7600T, MX7600FFL, MX7600I, MX7600DR, MX5100T, MX5600) Nautilus Hyosung, <https://www.nhatm.com/front/product/financialList.do>, Copyright @ 2011 Nautilus Hyosung. All Rights Reserved#2,2011. (Year: 2011).*

(22) Filed: **May 28, 2019**

(30) **Foreign Application Priority Data**

Nov. 30, 2018 (KR) 30-2018-0056431

Primary Examiner — Elizabeth J Oswecki

(51) **LOC (13) Cl.** **99-00**

(74) *Attorney, Agent, or Firm* — Bacon & Thomas, PLLC

(52) **U.S. Cl.**

USPC **D99/28**

(57) **CLAIM**

(58) **Field of Classification Search**

USPC D99/28, 34, 35, 36, 43, 99;

The ornamental design for an automated teller machine, as shown and described.

D14/300-302, 305, 307, 900-902;

D18/3.1-3.3, 4.1-4.6, 12.1-12.3;

D21/324, 325, 329, 369, 370; 101/66;

109/1 R, 1 V, 2, 23, 24.1, 25, 58, 58.5,

109/66; 446/8-13; 705/16, 17, 18, 42,

705/43, 44, 45; 235/51, 379, 380, 381,

235/382, 382.5, 386; 206/0.8, 0.81,

206/0.815, 0.82, 0.84

CPC .. G06Q 20/10; G06Q 20/108; G06Q 20/1085;

G06Q 20/18; G07D 1/00; G07D 1/02;

G07D 1/04; G07D 1/06; G07D 11/00;

G07D 9/002; G07D 9/04; G07F 19/20;

G07F 19/201; G07F 19/202; G07F

19/203; G07F 19/204; G07F 19/105;

G07F 19/21; G07F 19/00; G07F 7/04;

G07F 5/00; G07F 1/00; E05G 1/006;

A63H 33/00; A63H 33/005

See application file for complete search history.

DESCRIPTION

FIG. 1 is a perspective view of an automated teller machine, showing our new design;

FIG. 2 is a front view thereof;

FIG. 3 is a rear view thereof;

FIG. 4 is a left side view thereof;

FIG. 5 is a right side view thereof;

FIG. 6 is a top view thereof; and,

FIG. 7 is a bottom view thereof.

The broken lines shown in the drawings represent portions of the automated teller machine that form no part of the claimed design.

The small circular pattern shown in FIGS. 1 and 2 are shown in broken lines and form no part of the claimed design.

1 Claim, 7 Drawing Sheets

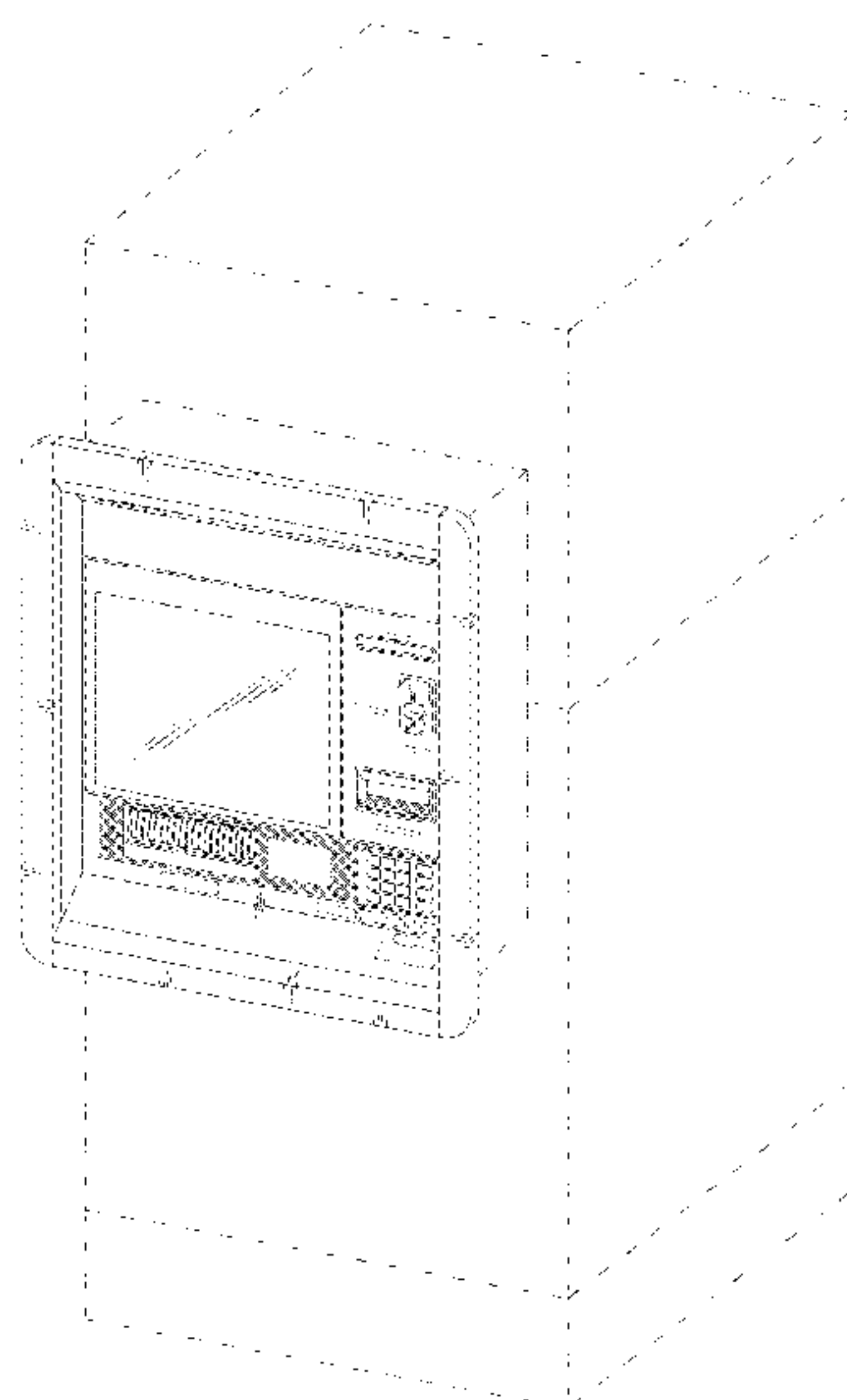

(56)

References Cited

U.S. PATENT DOCUMENTS

D411,905 S * 7/1999 Molander D99/28
 6,527,172 B1 * 3/2003 Lewis G07F 19/20
 235/375
 D481,516 S * 10/2003 Magee D99/28
 D481,517 S * 10/2003 Magee D99/28
 6,732,918 B2 * 5/2004 Coventry G07F 19/20
 235/379
 D492,080 S * 6/2004 Magee D99/28
 6,966,485 B2 * 11/2005 Lute, Jr. G06Q 20/1085
 235/379
 7,004,385 B1 * 2/2006 Douglass G06Q 20/327
 235/379
 7,040,534 B2 * 5/2006 Turocy G06Q 20/1085
 235/379
 7,229,009 B1 * 6/2007 Parsons G06Q 20/341
 235/379
 7,284,692 B1 * 10/2007 Douglass G06Q 20/352
 235/379
 D558,425 S * 12/2007 Dias D99/28
 7,513,420 B1 * 4/2009 Block G06Q 20/102
 235/379
 7,533,802 B1 * 5/2009 McGinley G07F 19/20
 235/376
 D596,374 S * 7/2009 Kang D99/28
 D597,275 S * 7/2009 Lee D99/28
 D602,225 S * 10/2009 Lute D99/28
 D615,274 S * 5/2010 Kim D99/28
 D625,485 S * 10/2010 Lee D99/28

7,891,546 B1 * 2/2011 Steinbach G06Q 20/40
 235/375
 7,959,072 B1 * 6/2011 Jenkins G07F 19/20
 235/379
 D652,601 S * 1/2012 Rohan D99/28
 D672,525 S * 12/2012 Lee D99/28
 D696,484 S * 12/2013 Lee D99/28
 D696,485 S * 12/2013 Lee D99/28
 D765,340 S * 8/2016 Lee D99/28
 D825,883 S * 8/2018 Oh D99/28
 D901,825 S * 11/2020 Nelson D99/28
 D905,375 S * 12/2020 Lee D99/28
 2004/0262379 A1 * 12/2004 Gomes G07F 17/248
 235/379
 2005/0029340 A1 * 2/2005 Ferraro G07F 19/205
 235/379
 2006/0073883 A1 * 4/2006 Franks, Jr. G07F 17/42
 463/25
 2006/0195567 A1 * 8/2006 Mody G07F 19/20
 709/224
 2008/0265019 A1 * 10/2008 Artino G07F 19/202
 235/379
 2008/0296365 A1 * 12/2008 Schliebe G07F 19/2055
 235/379
 2009/0057398 A1 * 3/2009 Douglass G07F 19/00
 235/379
 2010/0161489 A1 * 6/2010 Goodall G07F 19/202
 705/45
 2010/0187300 A1 * 7/2010 Ramachandran G07F 19/207
 235/379

* cited by examiner

Fig 1

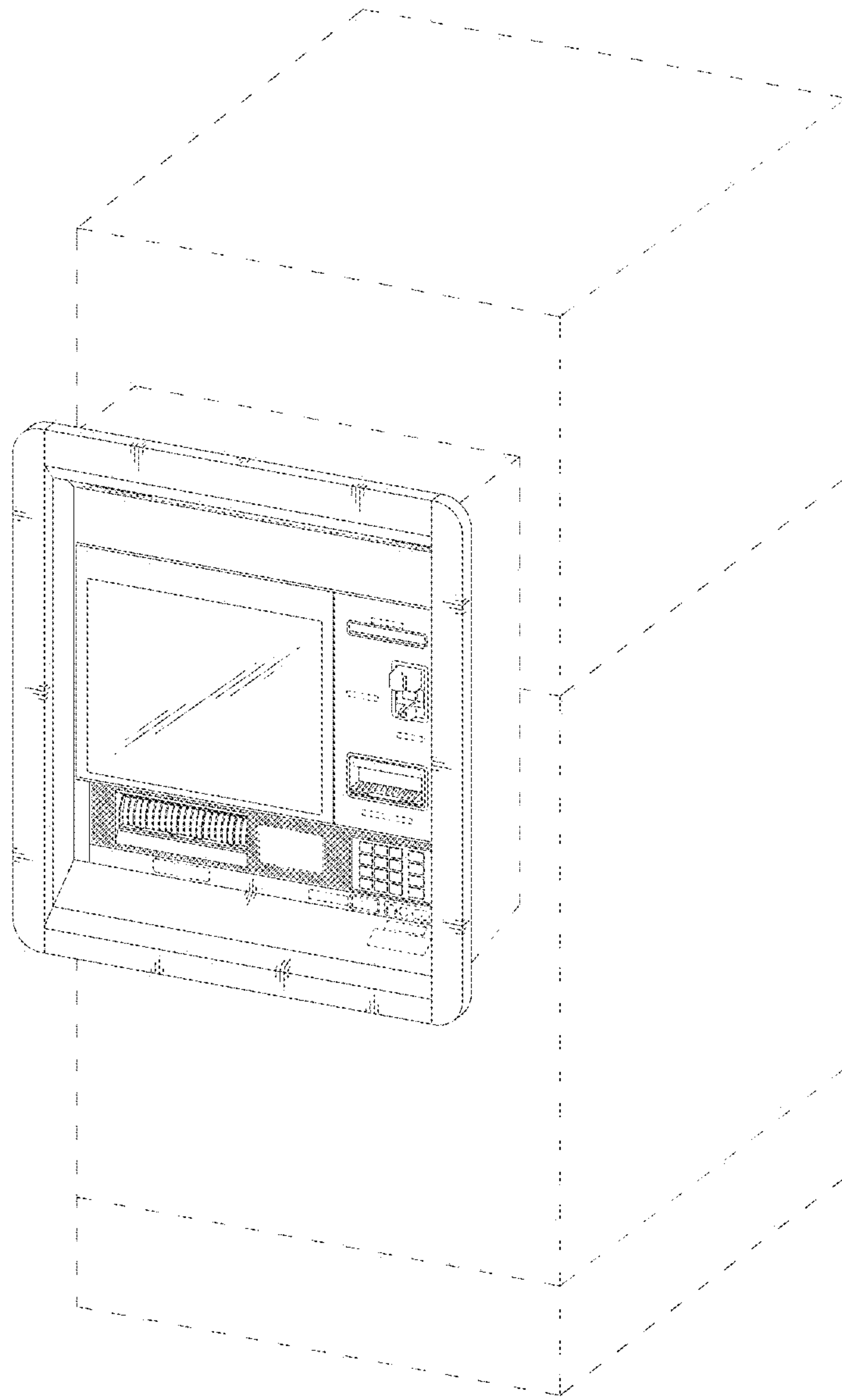

Fig 2

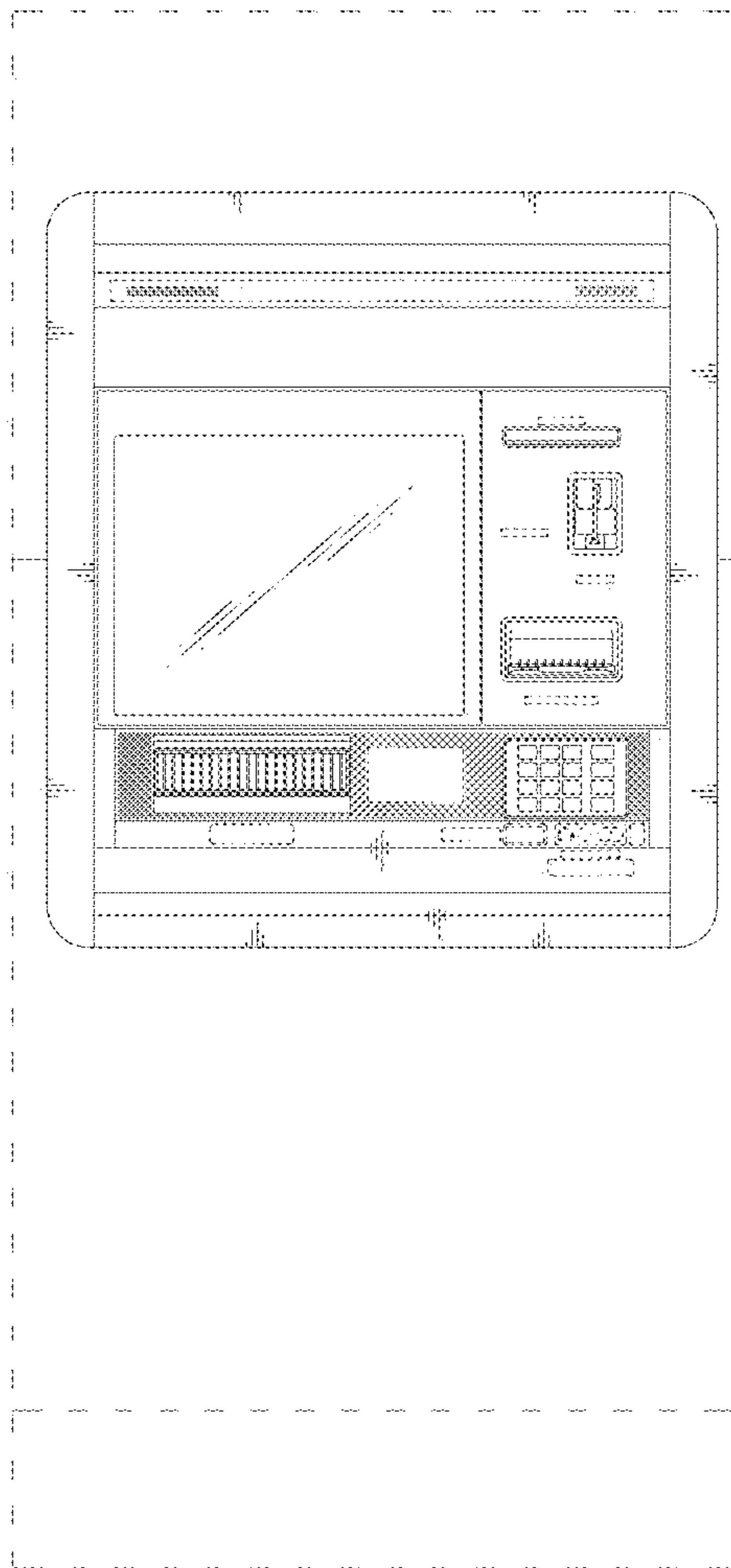

Fig 3

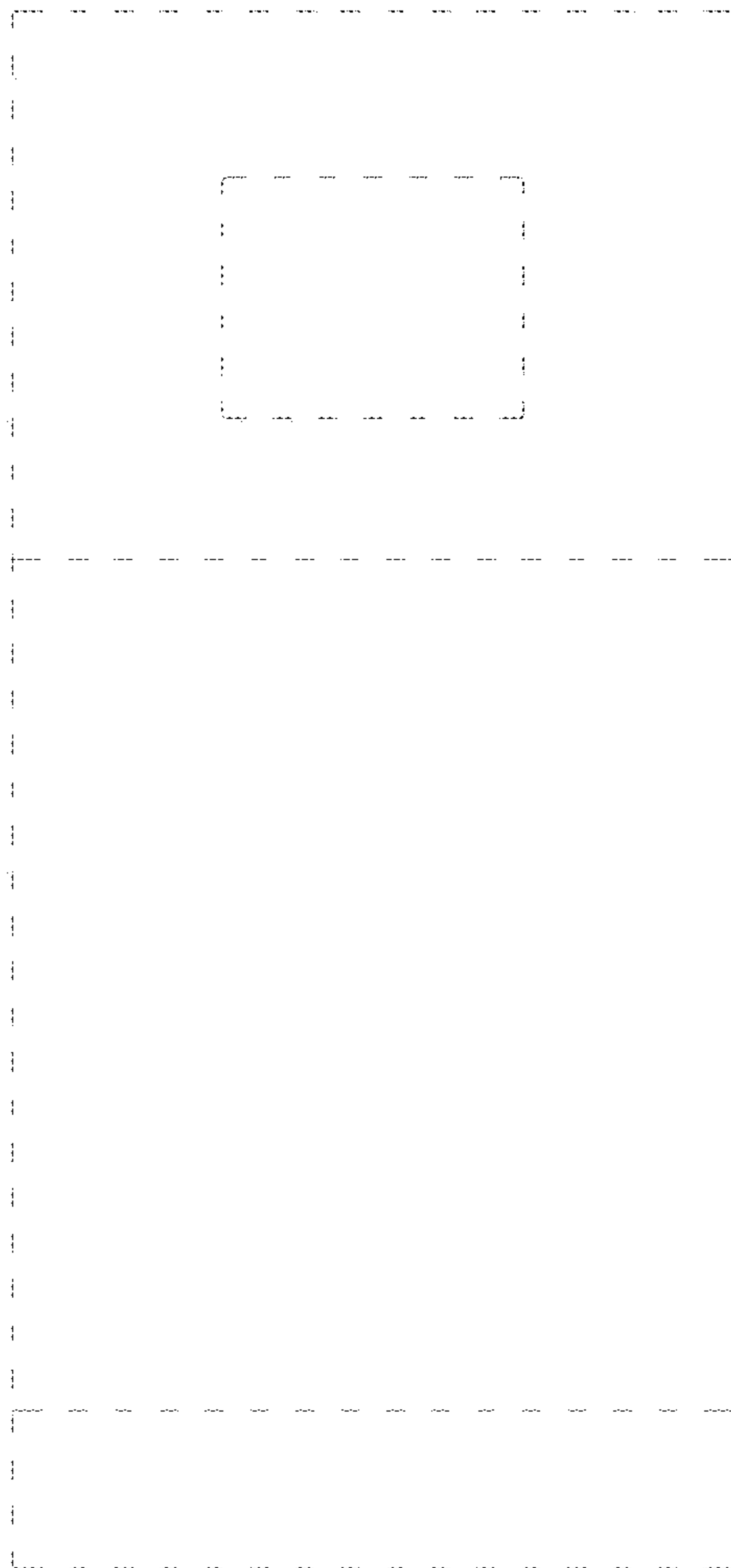

Fig 4

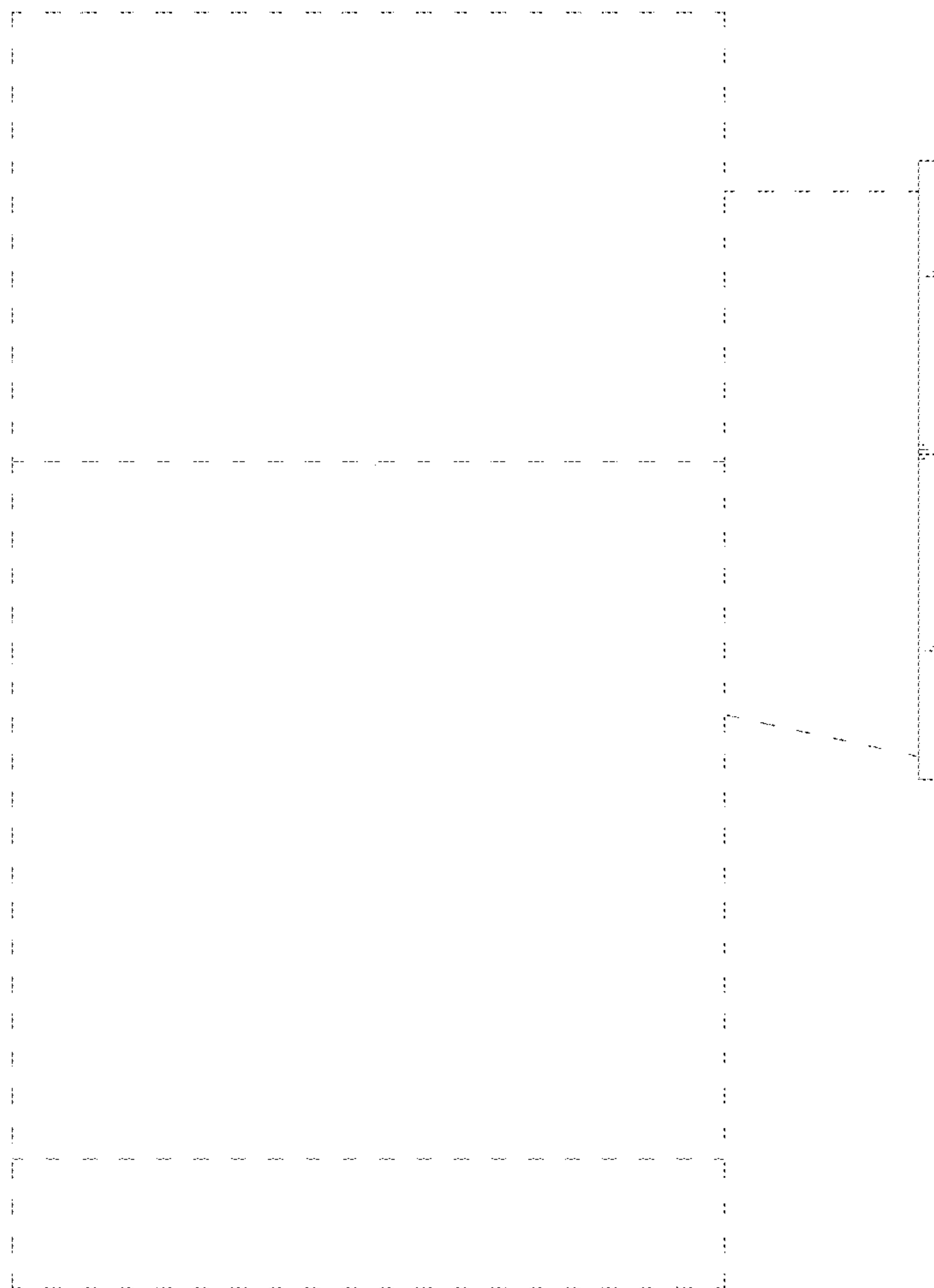

Fig 5

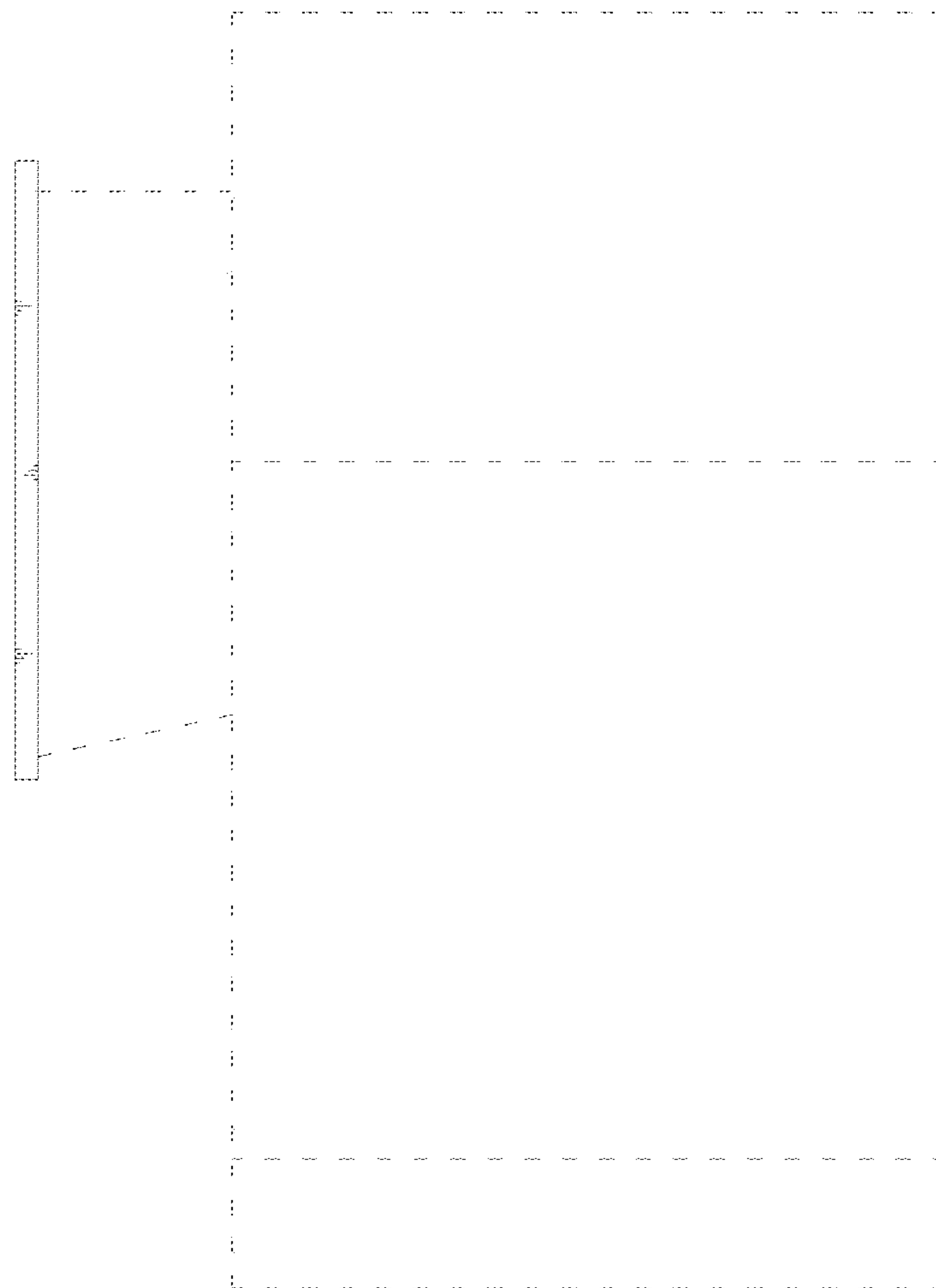

Fig 6

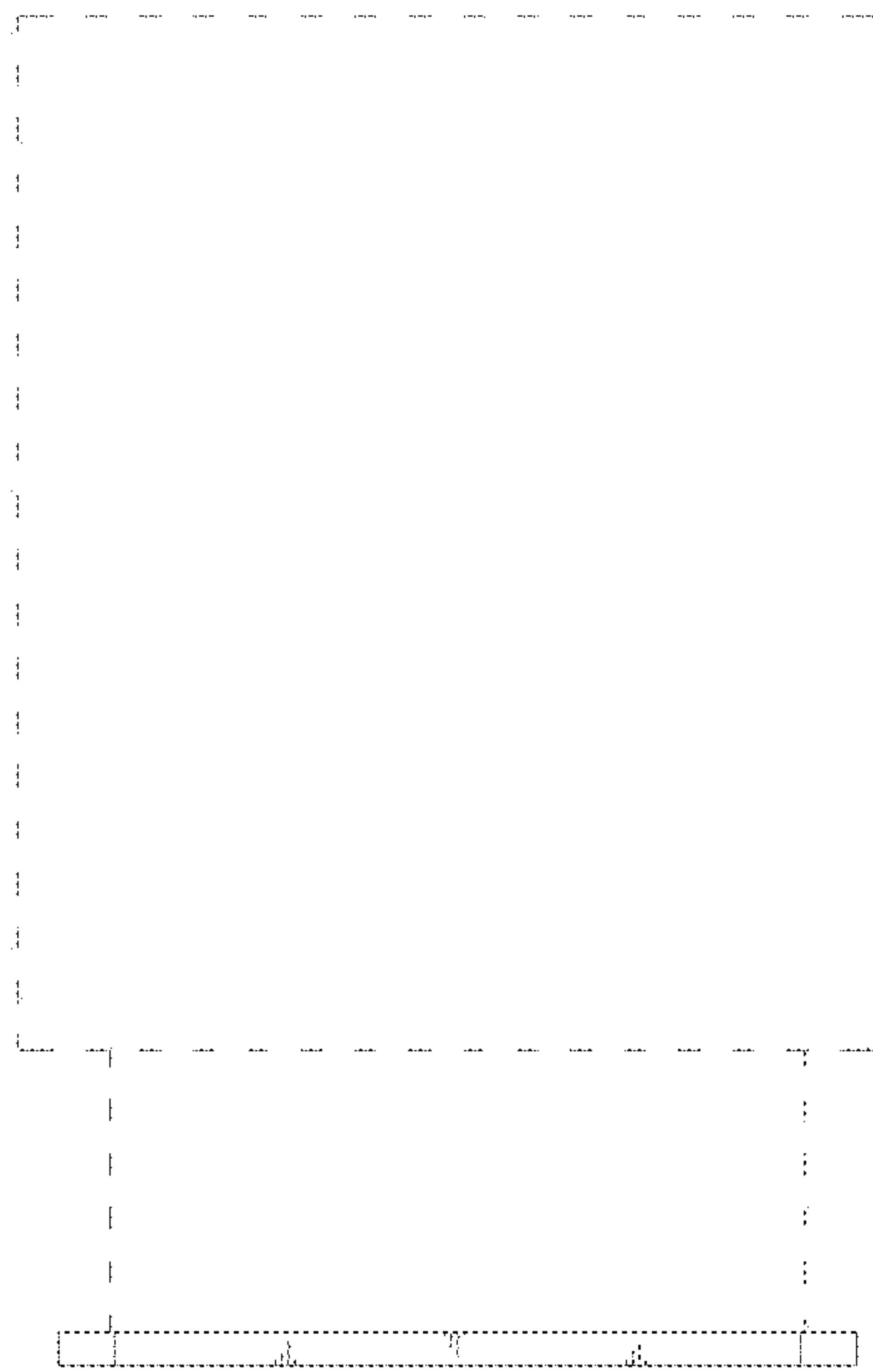

Fig 7

