



US00D942094S

(12) **United States Design Patent**
Courchesne

(10) **Patent No.:** **US D942,094 S**
(45) **Date of Patent:** **** Jan. 25, 2022**

(54) **LITTER BOX**

(71) Applicant: **Alain Courchesne**, Montreal (CA)

(72) Inventor: **Alain Courchesne**, Montreal (CA)

(**) Term: **15 Years**

(21) Appl. No.: **29/654,370**

(22) Filed: **Jun. 22, 2018**

(51) **LOC (13) Cl.** **30-99**

(52) **U.S. Cl.**
USPC **D30/161**

(58) **Field of Classification Search**
USPC D30/108-120, 158, 160, 161; D6/601,
D6/349, 595-597, 604, 382

(Continued)

(56) **References Cited**

U.S. PATENT DOCUMENTS

D635,726 S * 4/2011 Lawson D30/161
D653,818 S * 2/2012 Schetlin D30/158

(Continued)

Primary Examiner — Sheryl Lane

Assistant Examiner — Aula Soroush

(74) *Attorney, Agent, or Firm* — PRAXIS

(57) **CLAIM**

The ornamental design for a litter box, as shown and described.

DESCRIPTION

FIG. 1 is a perspective, front and side view of the litter box in accordance with the first embodiment of the Design, FIG. 2 is a front view of the litter box of FIG. 1; FIG. 3 is a rear view of the litter box of FIG. 1; FIG. 4 is a left side view of the litter box of FIG. 1;

FIG. 5 is a right side view of the litter box of FIG. 1; FIG. 6 is a top plan view of the litter box of FIG. 1; FIG. 7 is a bottom view of the litter box of FIG. 1; FIG. 8 is a perspective, front and side view of the litter box in accordance with the second embodiment of the Design, FIG. 9 is a front view of the litter box of FIG. 8; FIG. 10 is a rear view of the litter box of FIG. 8; FIG. 11 is a left side view of the litter box of FIG. 8; FIG. 12 is a right side view of the litter box of FIG. 8; FIG. 13 is a top plan view of the litter box of FIG. 8; FIG. 14 is a bottom view of the litter box of FIG. 8; FIG. 15 is a perspective, front and side view of the litter box in accordance with the third embodiment of the Design, FIG. 16 is a front view of the litter box of FIG. 15; FIG. 17 is a rear view of the litter box of FIG. 15; FIG. 18 is a left side view of the litter box of FIG. 15; FIG. 19 is a right side view of the litter box of FIG. 15; FIG. 20 is a top plan view of the litter box of FIG. 15; FIG. 21 is a bottom view of the litter box of FIG. 15; FIG. 22 is a perspective, front and side view of the litter box in accordance with the fourth embodiment of the Design, FIG. 23 is a front view of the litter box of FIG. 22; FIG. 24 is a rear view of the litter box of FIG. 22; FIG. 25 is a left side view of the litter box of FIG. 22; FIG. 26 is a right side view of the litter box of FIG. 22; FIG. 27 is a top plan view of the litter box of FIG. 22; FIG. 28 is a bottom view of the litter box of FIG. 22; FIG. 29 is a perspective, front and side view of the litter box in accordance with the fifth embodiment of the Design, FIG. 30 is a front view of the litter box of FIG. 29; FIG. 31 is a rear view of the litter box of FIG. 29; FIG. 32 is a left side view of the litter box of FIG. 29; FIG. 33 is a right side view of the litter box of FIG. 29; FIG. 34 is a top plan view of the litter box of FIG. 29; and, FIG. 35 is a bottom view of the litter box of FIG. 29.

The broken line portions depict subject matter that forms no part of the claimed design. The parallel lines broken by zigzag shown in the Figures illustrate represent a break in length and form no part of the claimed design.

1 Claim, 20 Drawing Sheets

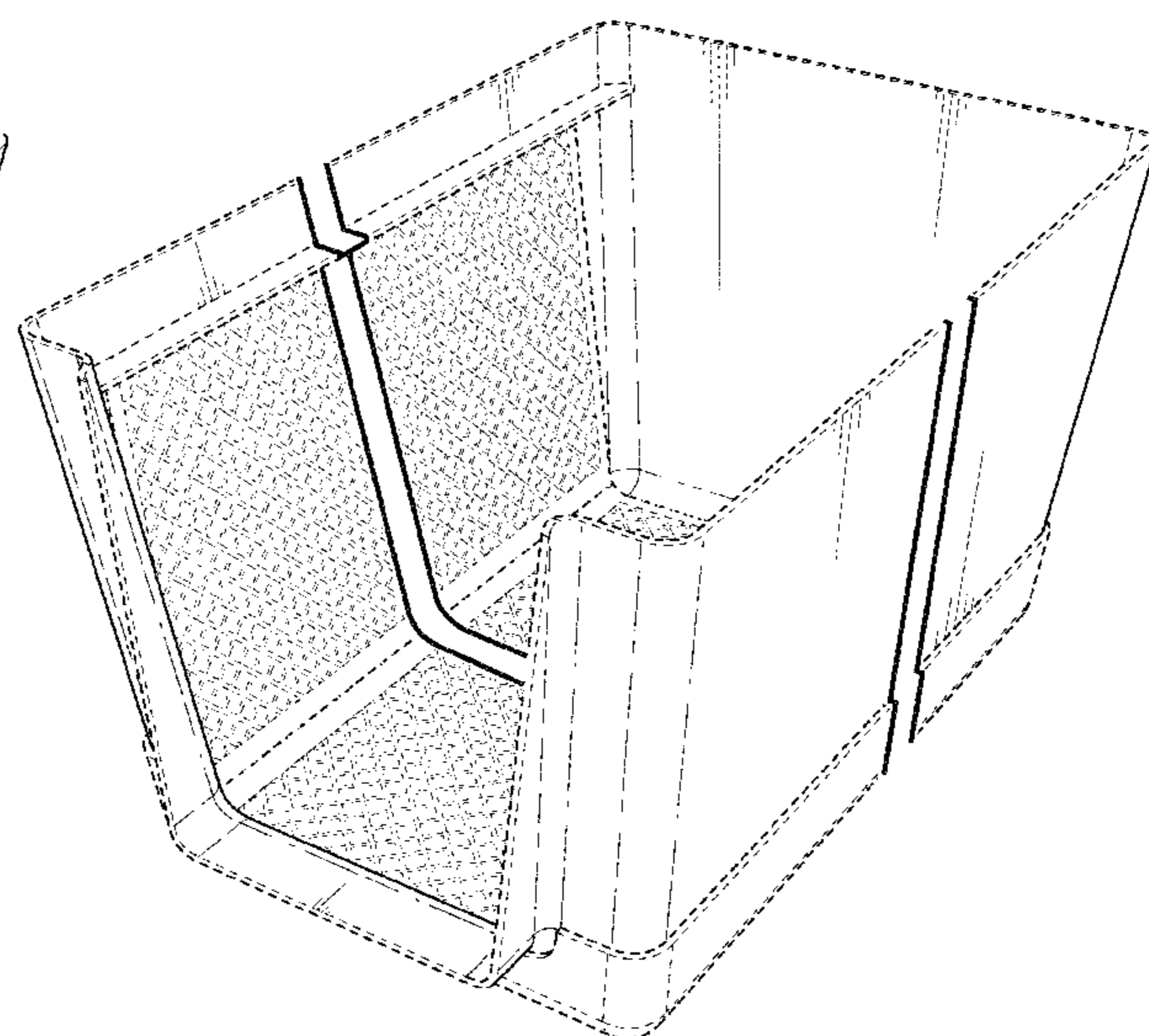
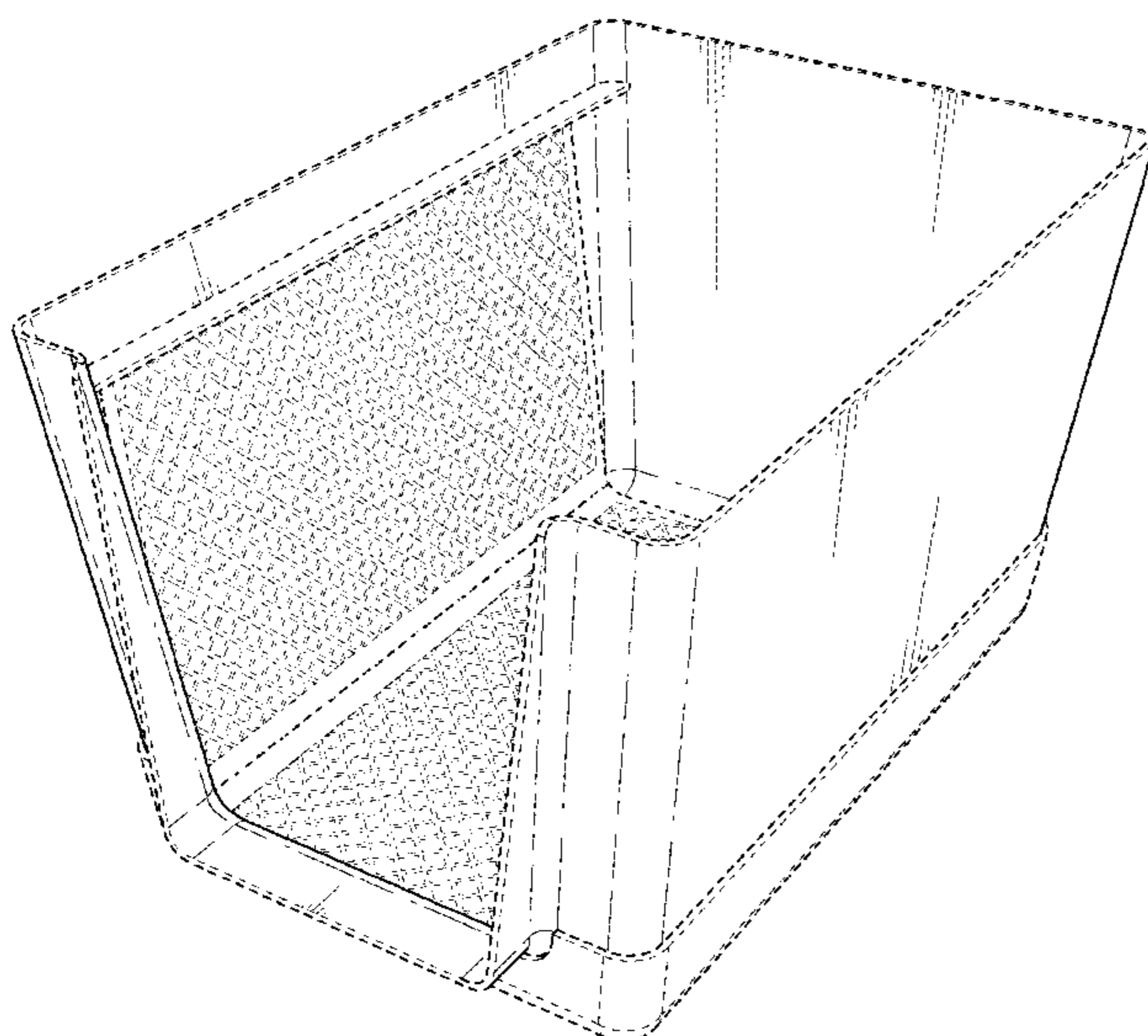

(58) **Field of Classification Search**

CPC A01K 1/00; A01K 1/0272; A01K 1/0353;
A01K 1/035; A01K 1/0017; A01K
1/0245; A01K 1/0035; A01K 1/0151;
A01K 1/0114; A01K 1/0125; A01K
1/0152; A01K 1/0107; A47C 21/02

See application file for complete search history.

(56) **References Cited**

U.S. PATENT DOCUMENTS

D762,065	S	*	7/2016	Hsu	D3/304
D764,169	S	*	8/2016	Bougay	D3/304
D782,755	S	*	3/2017	Veness	D30/161
D850,029	S	*	5/2019	Williams	D30/161
D888,352	S	*	6/2020	Olivier	D30/161
D897,056	S	*	9/2020	Takai	D30/161
2009/0178622	A1	*	7/2009	Havluciyani	A01K 1/0107 119/161
2014/0251224	A1	*	9/2014	Yamamoto	A01K 1/0114 119/165
2020/0163306	A1	*	5/2020	Takai	A01K 1/0107

* cited by examiner

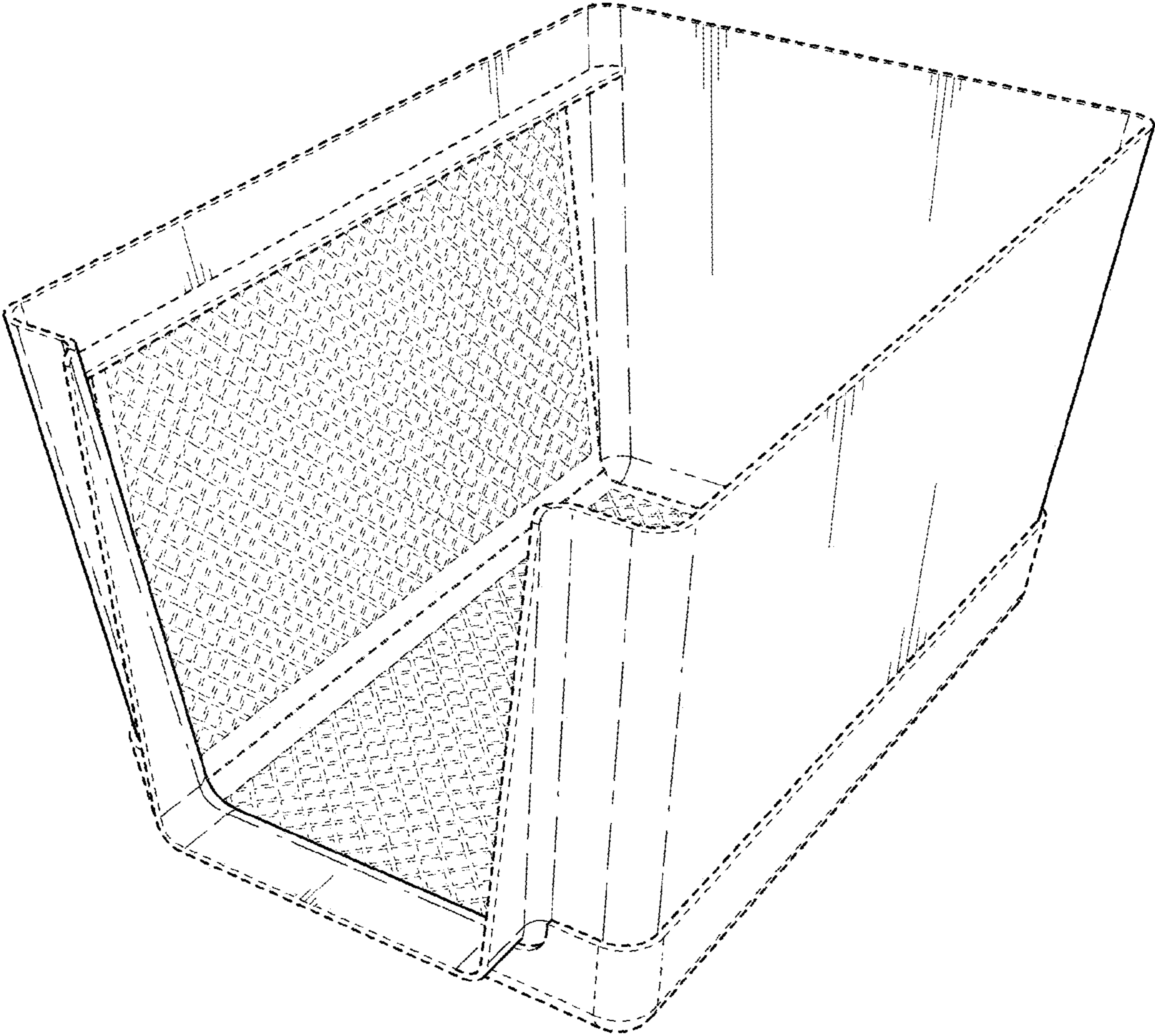

FIG. 1

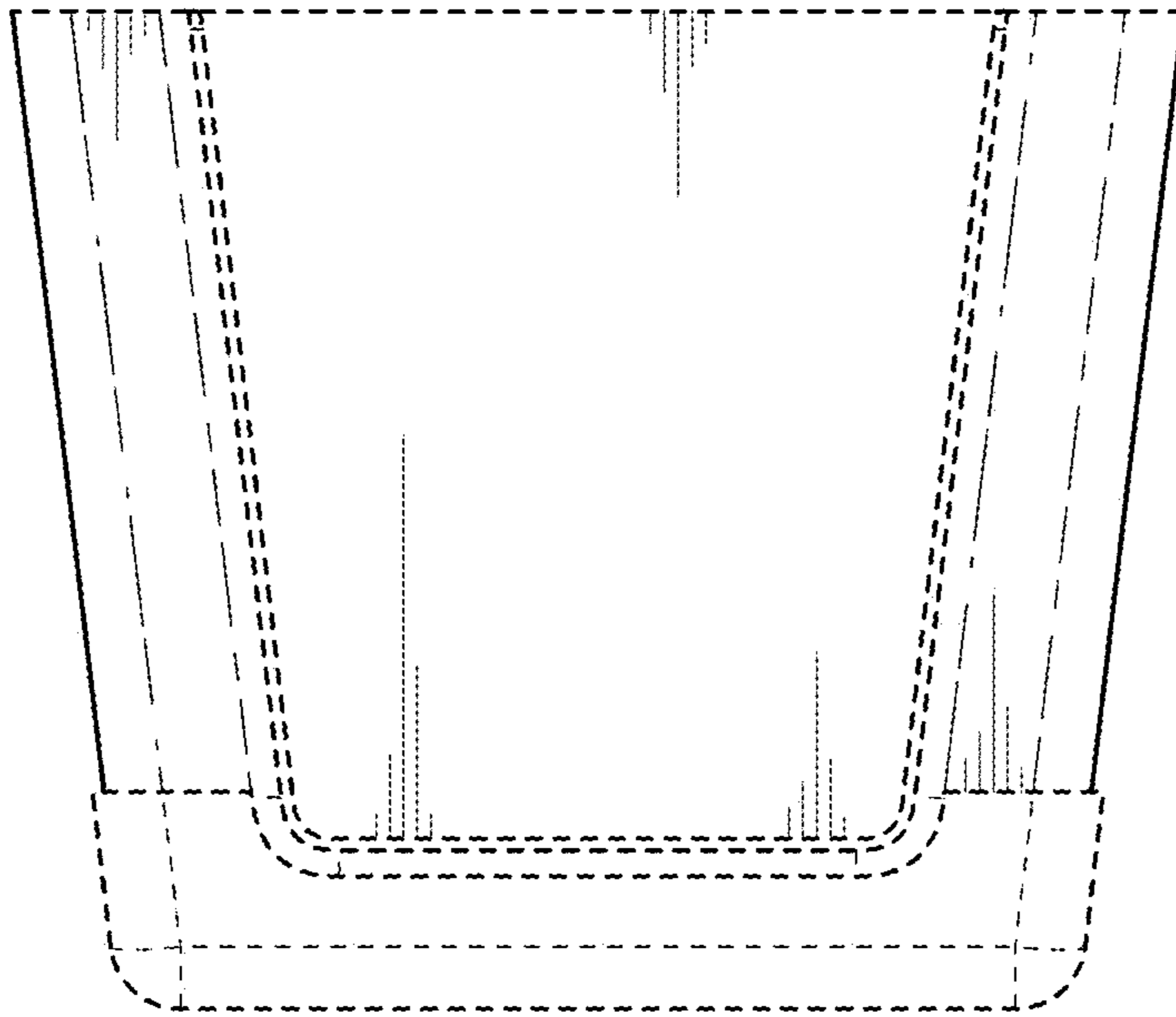

FIG. 2

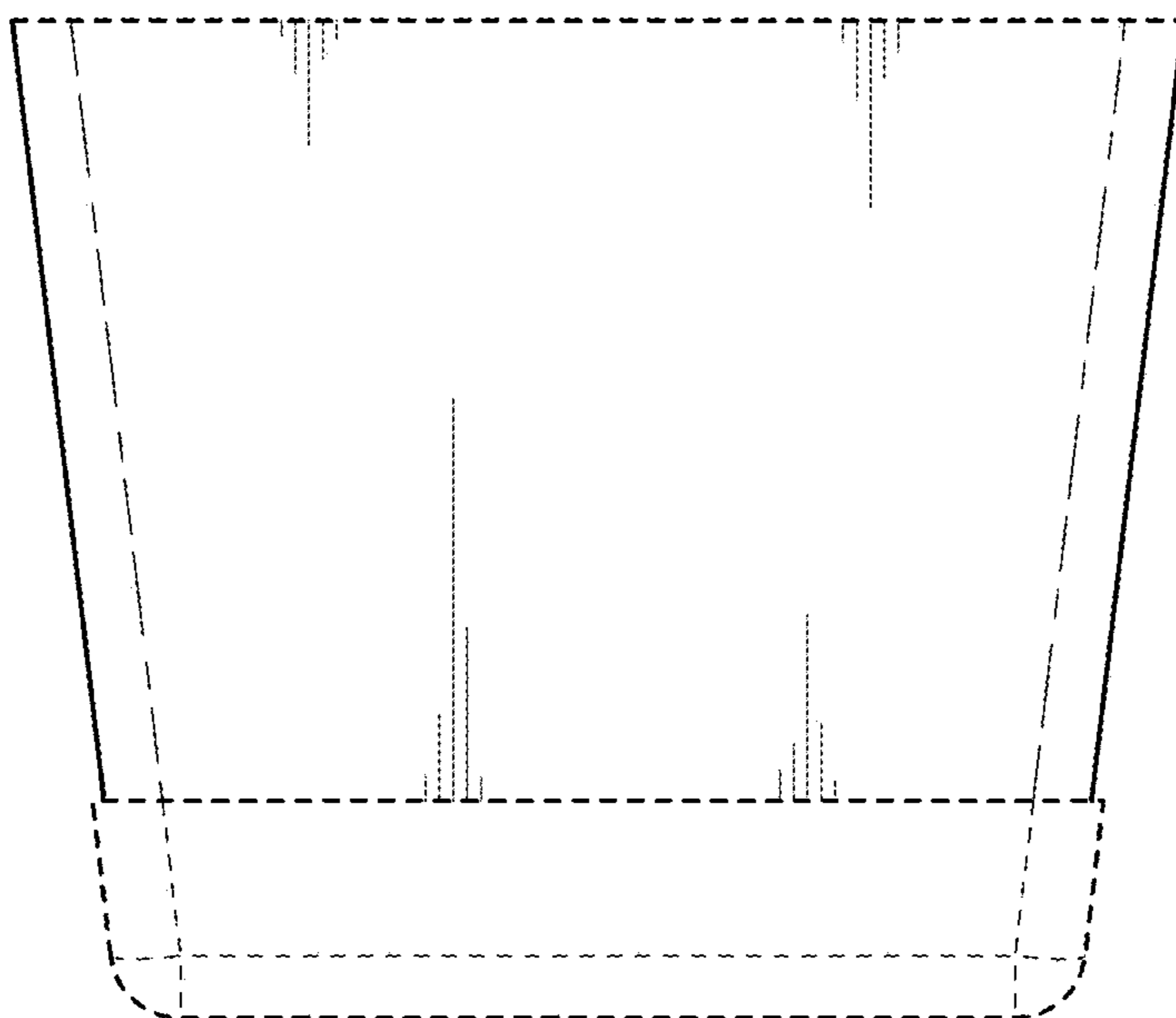

FIG. 3

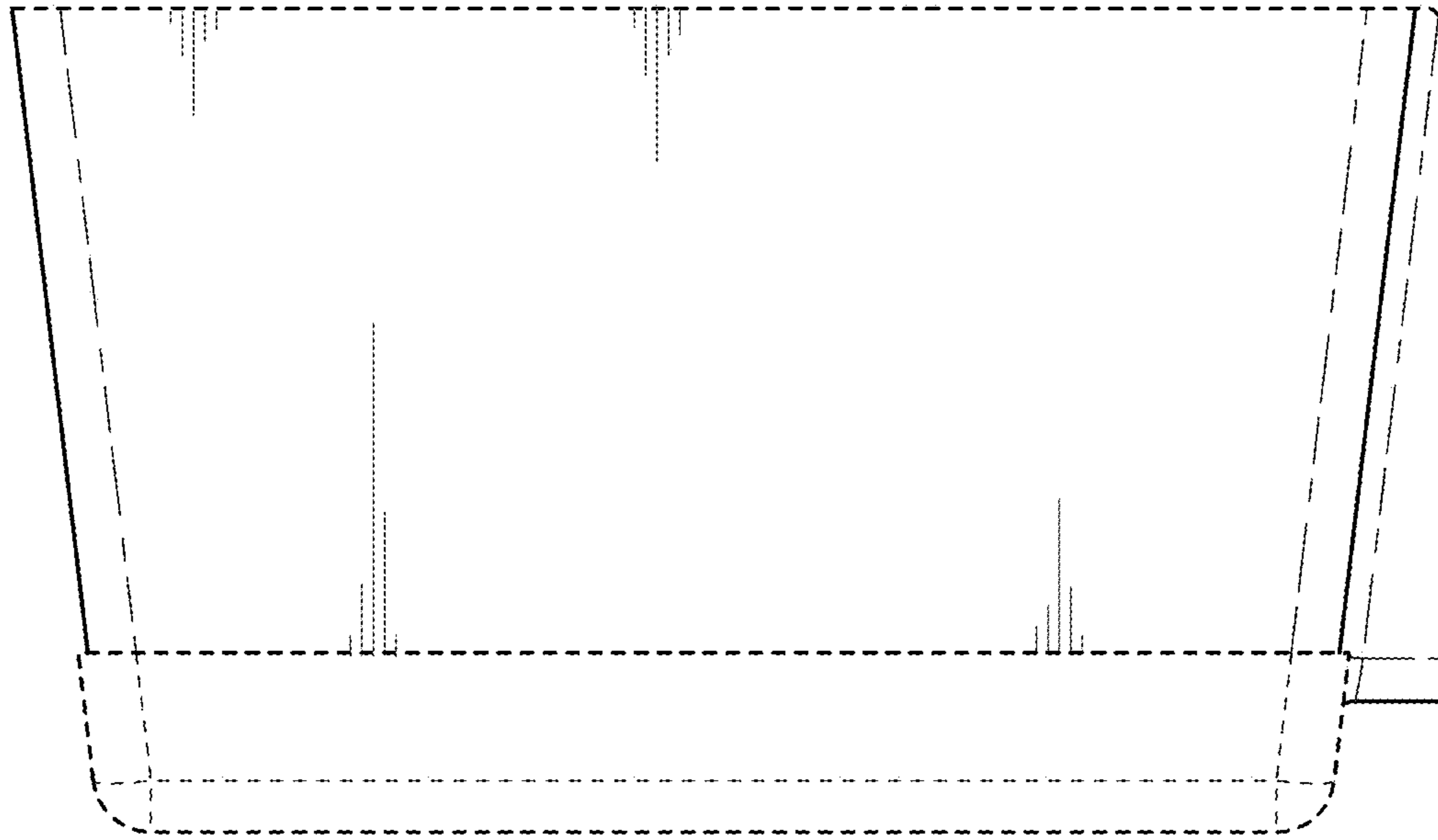

FIG. 4

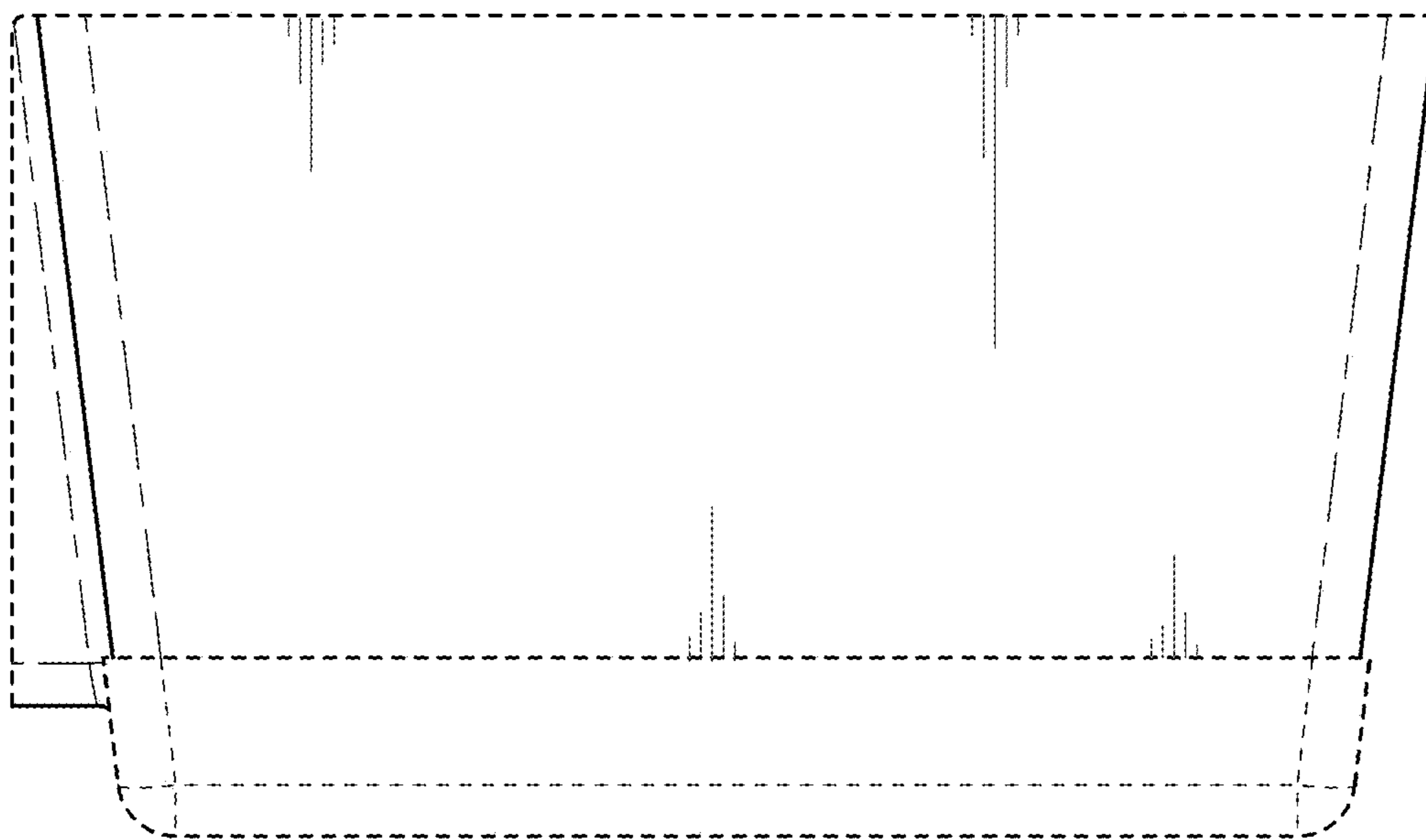

FIG. 5

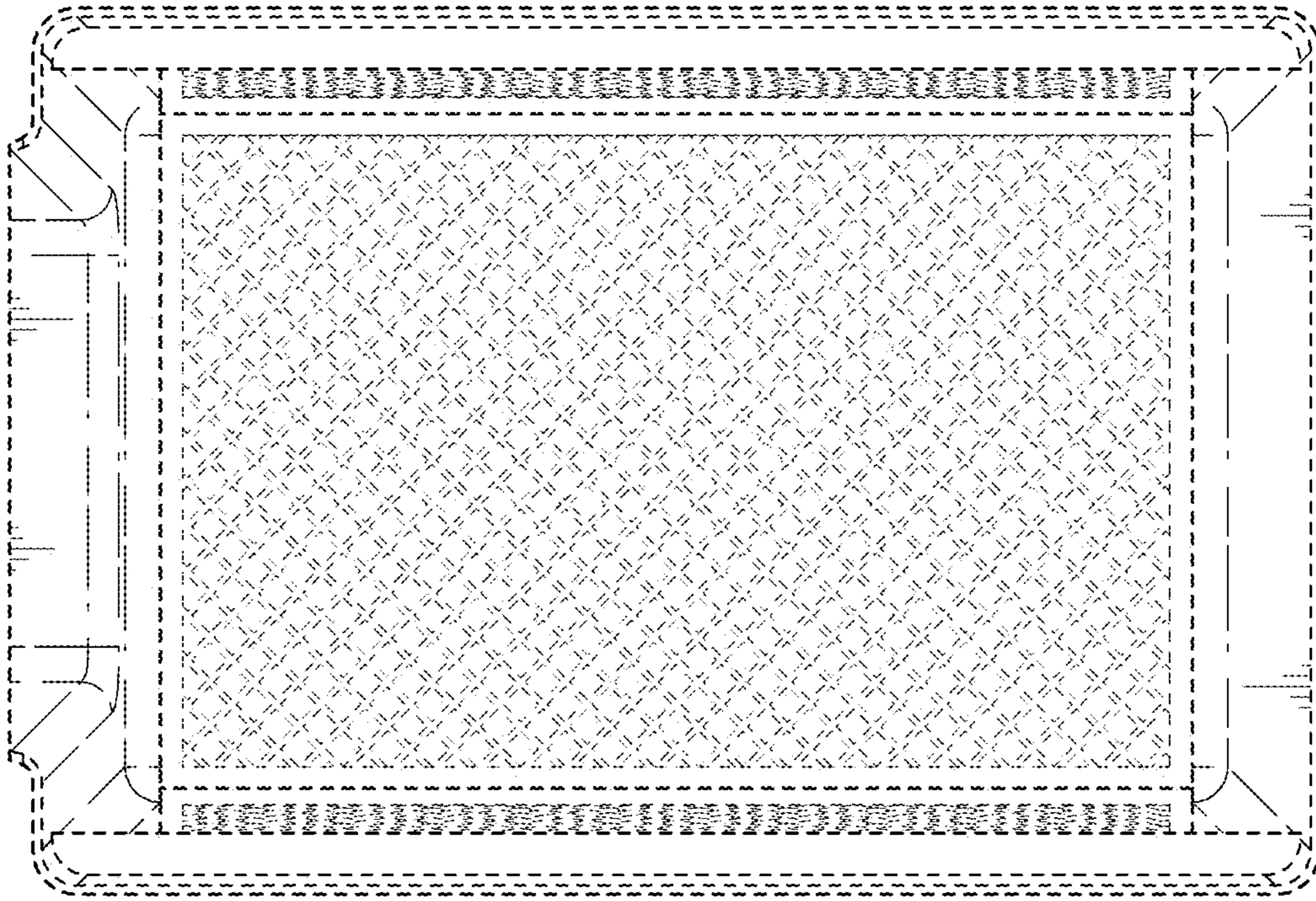

FIG. 6



FIG. 7

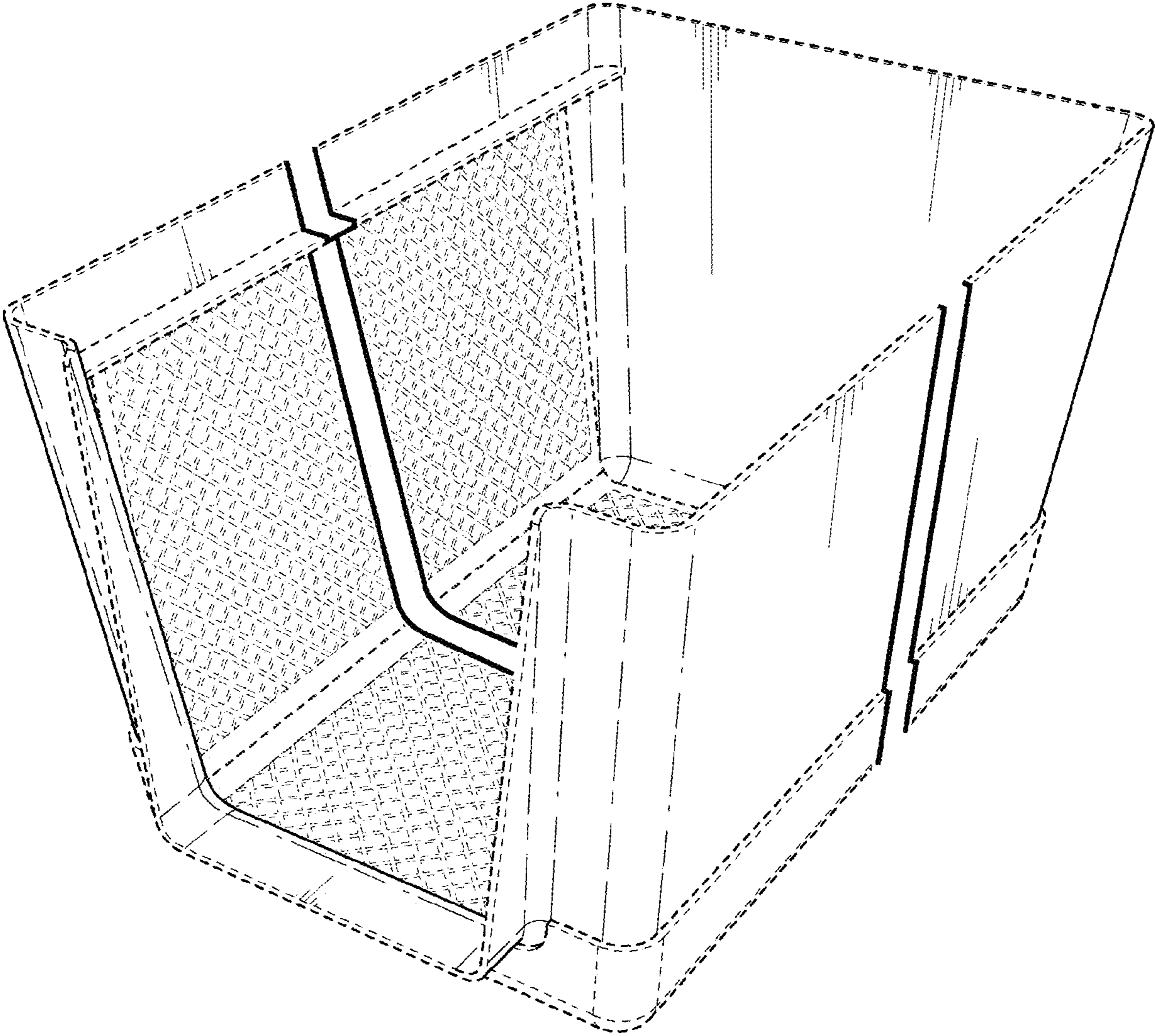

FIG. 8

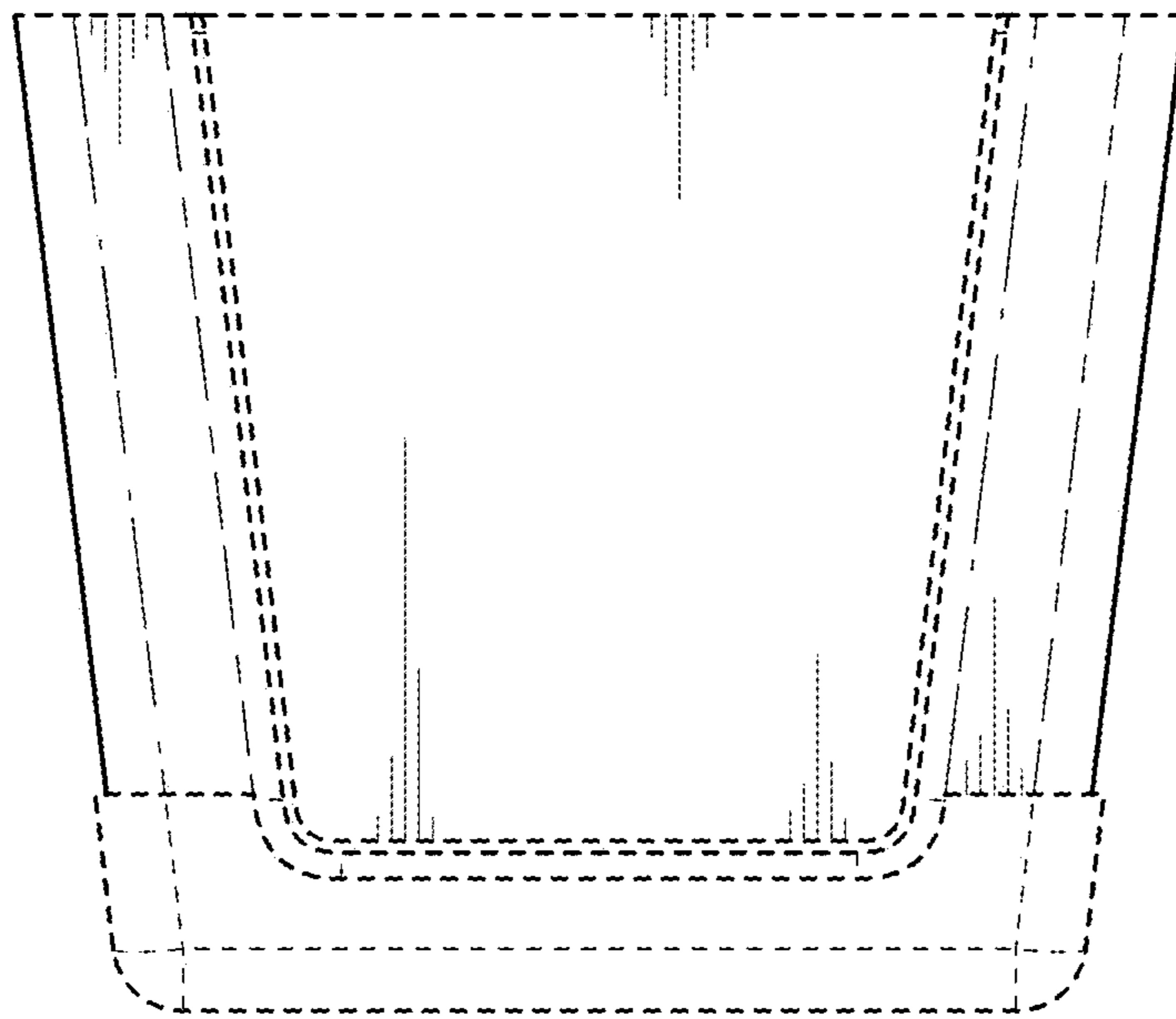

FIG. 9

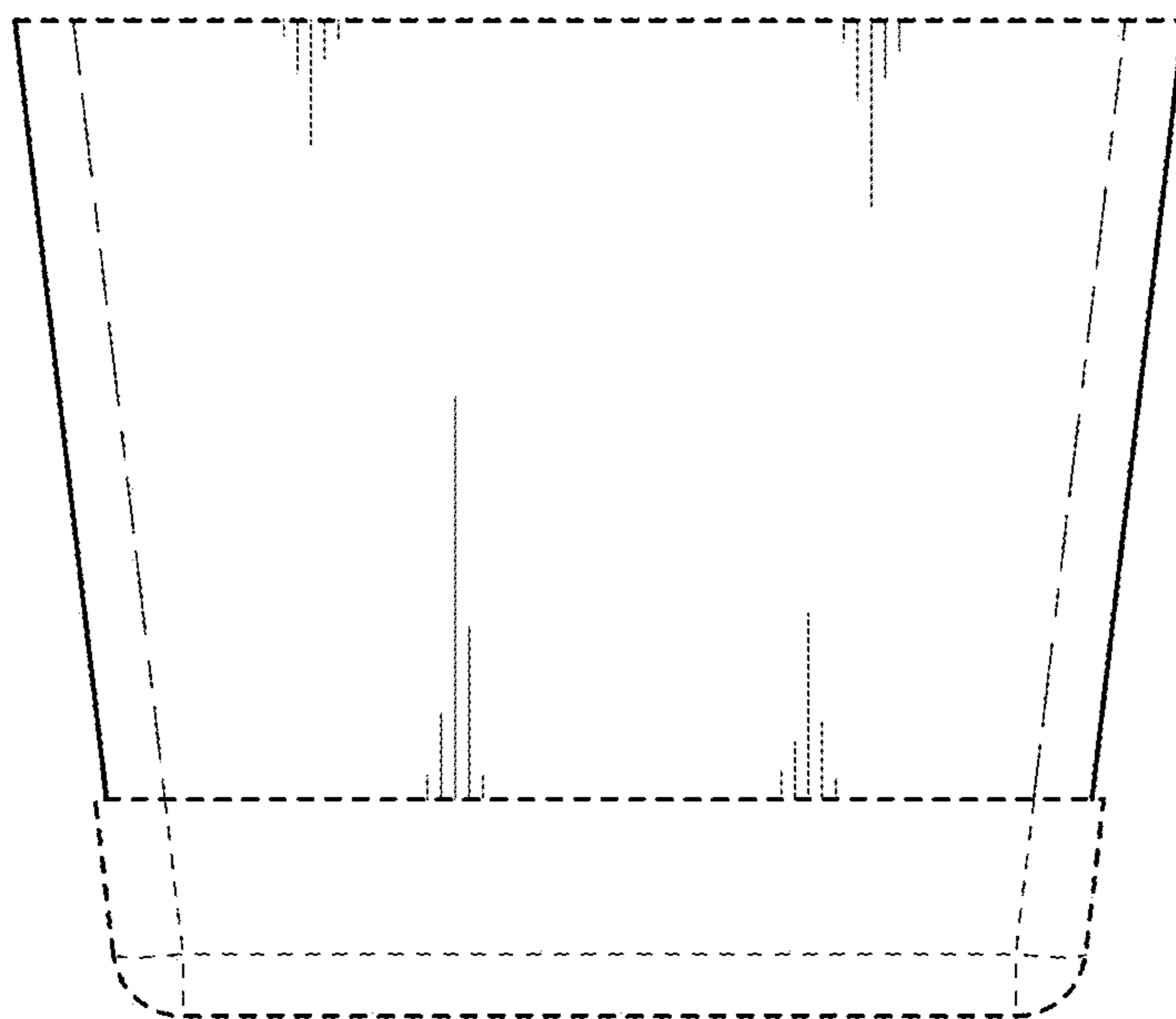

FIG. 10

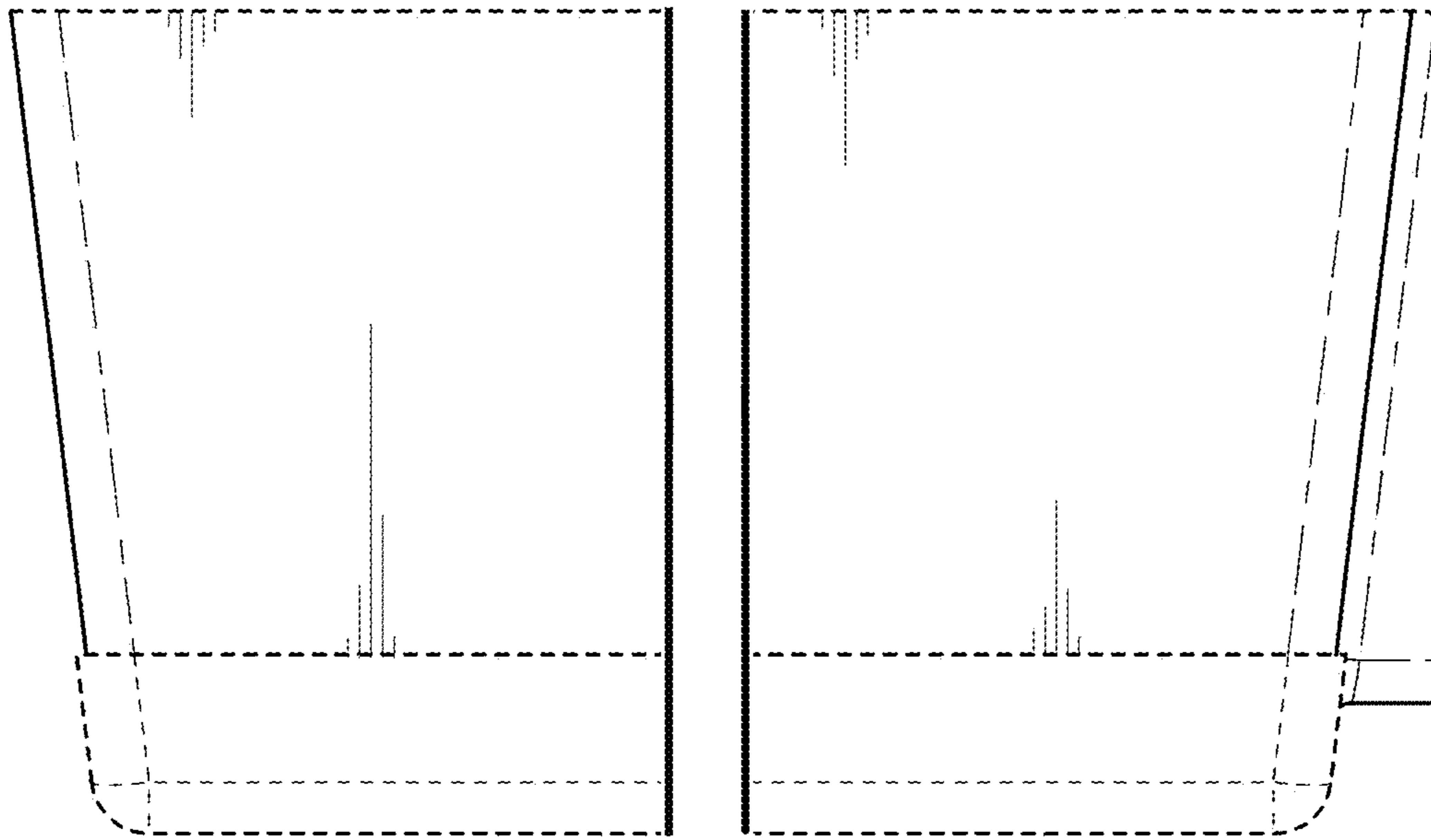

FIG. 11

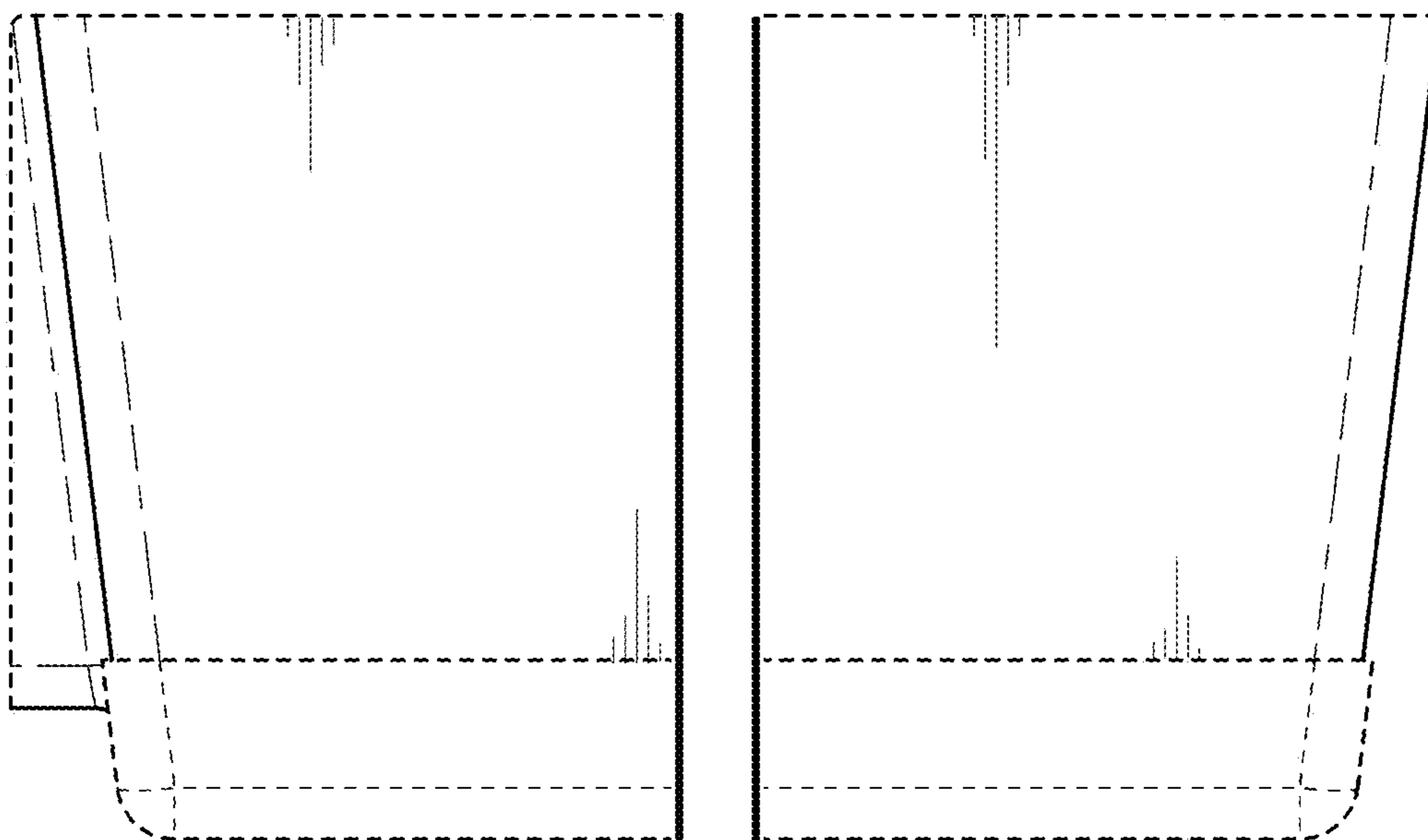

FIG. 12

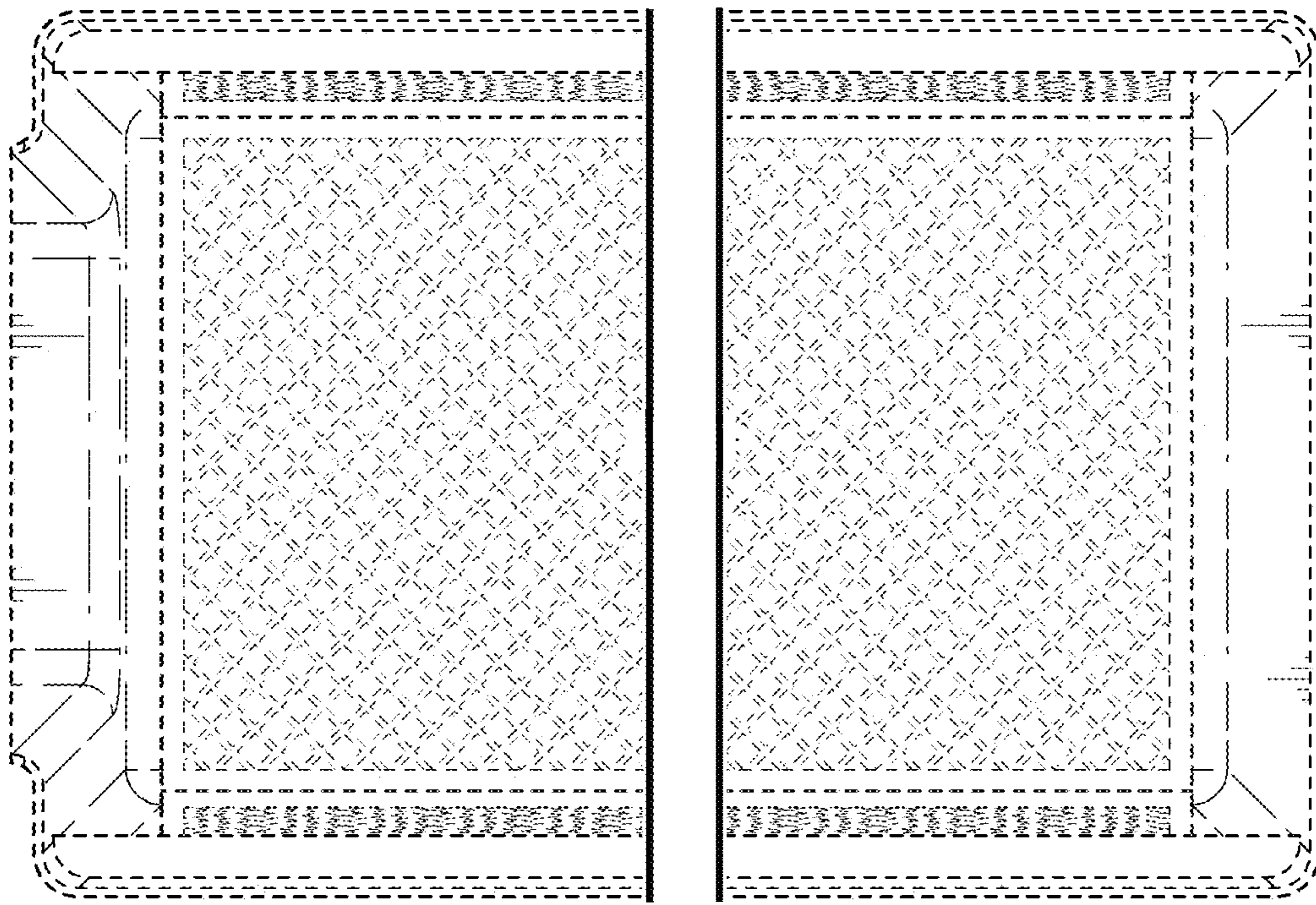

FIG. 13

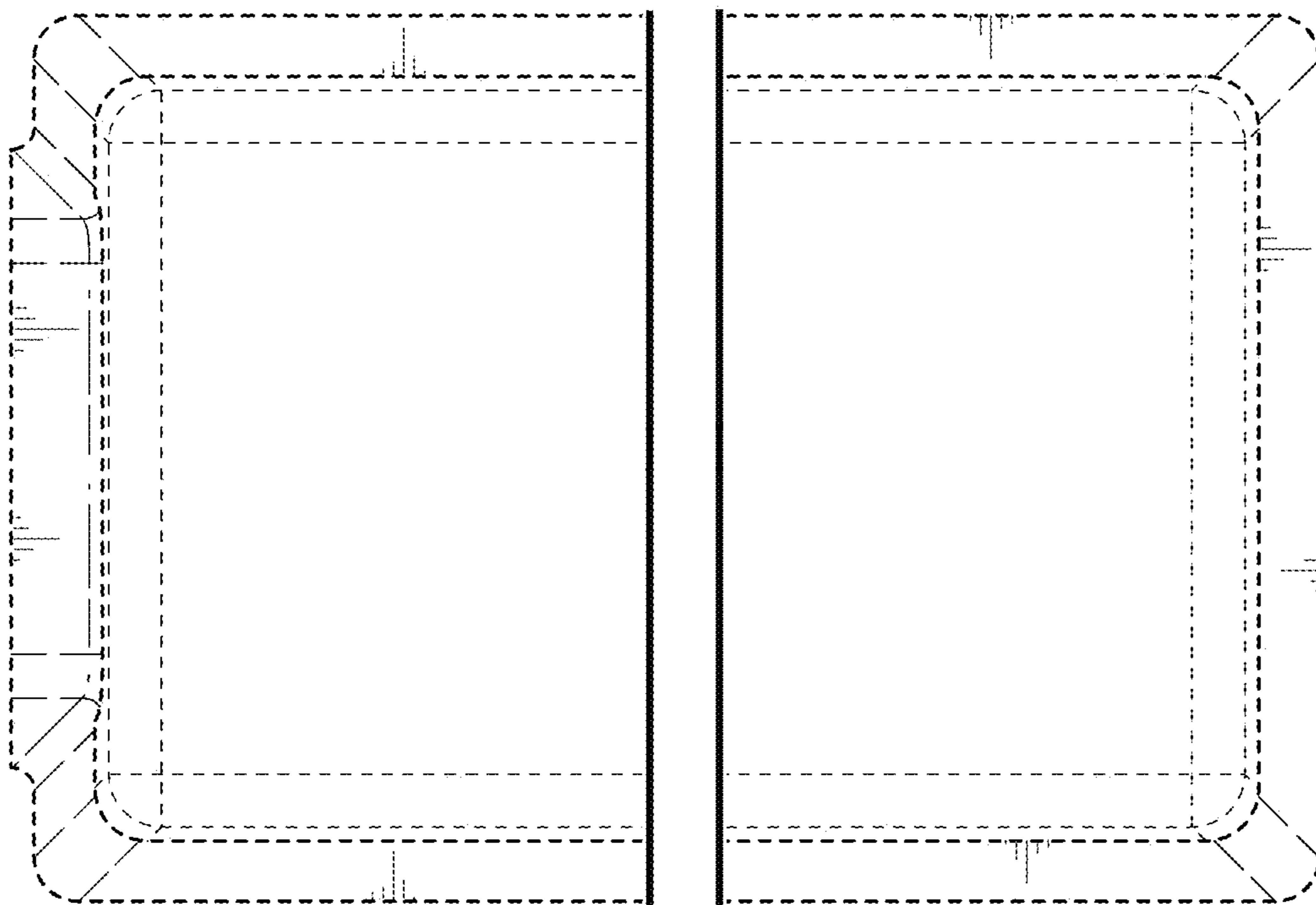

FIG. 14

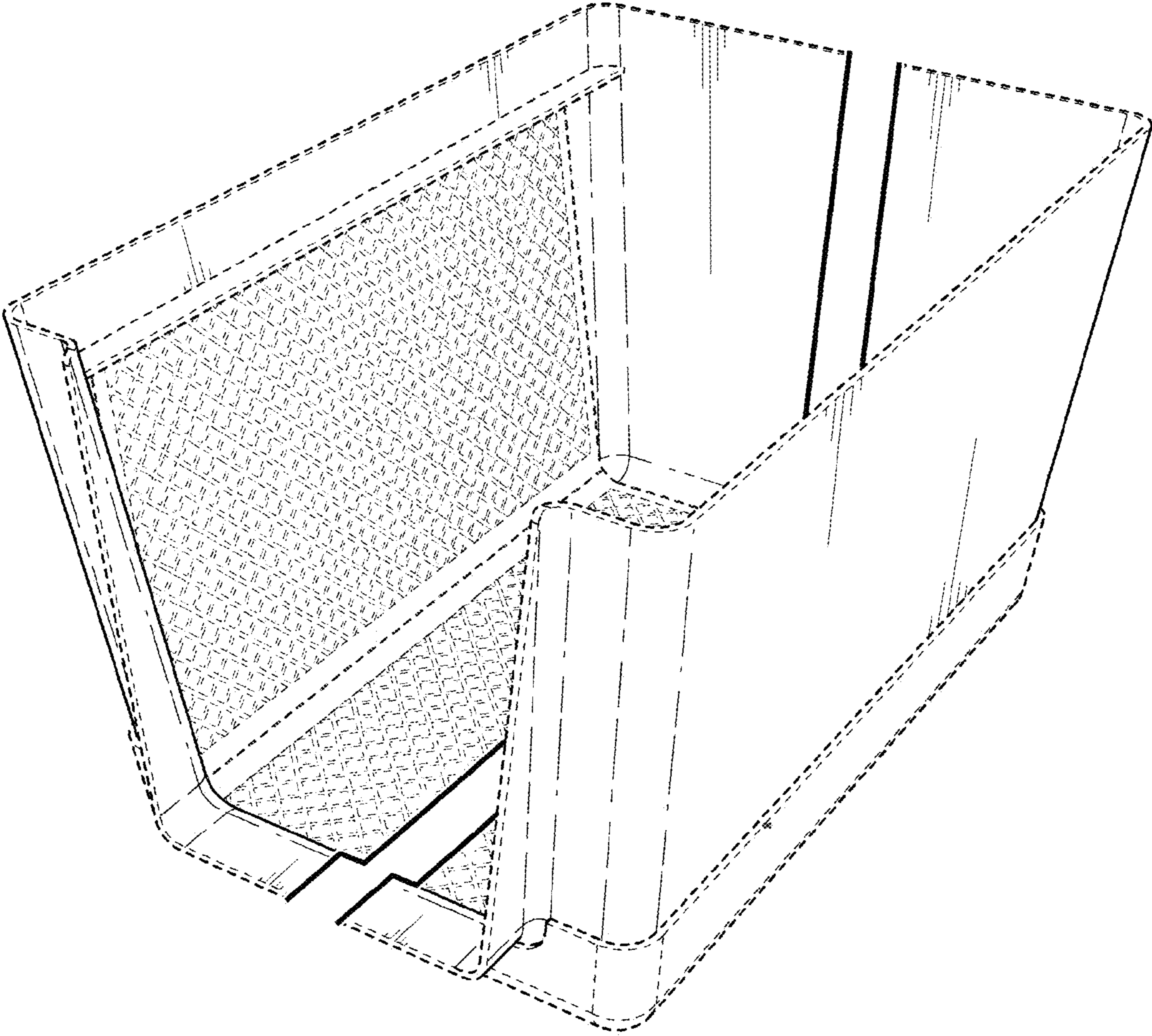

FIG.15

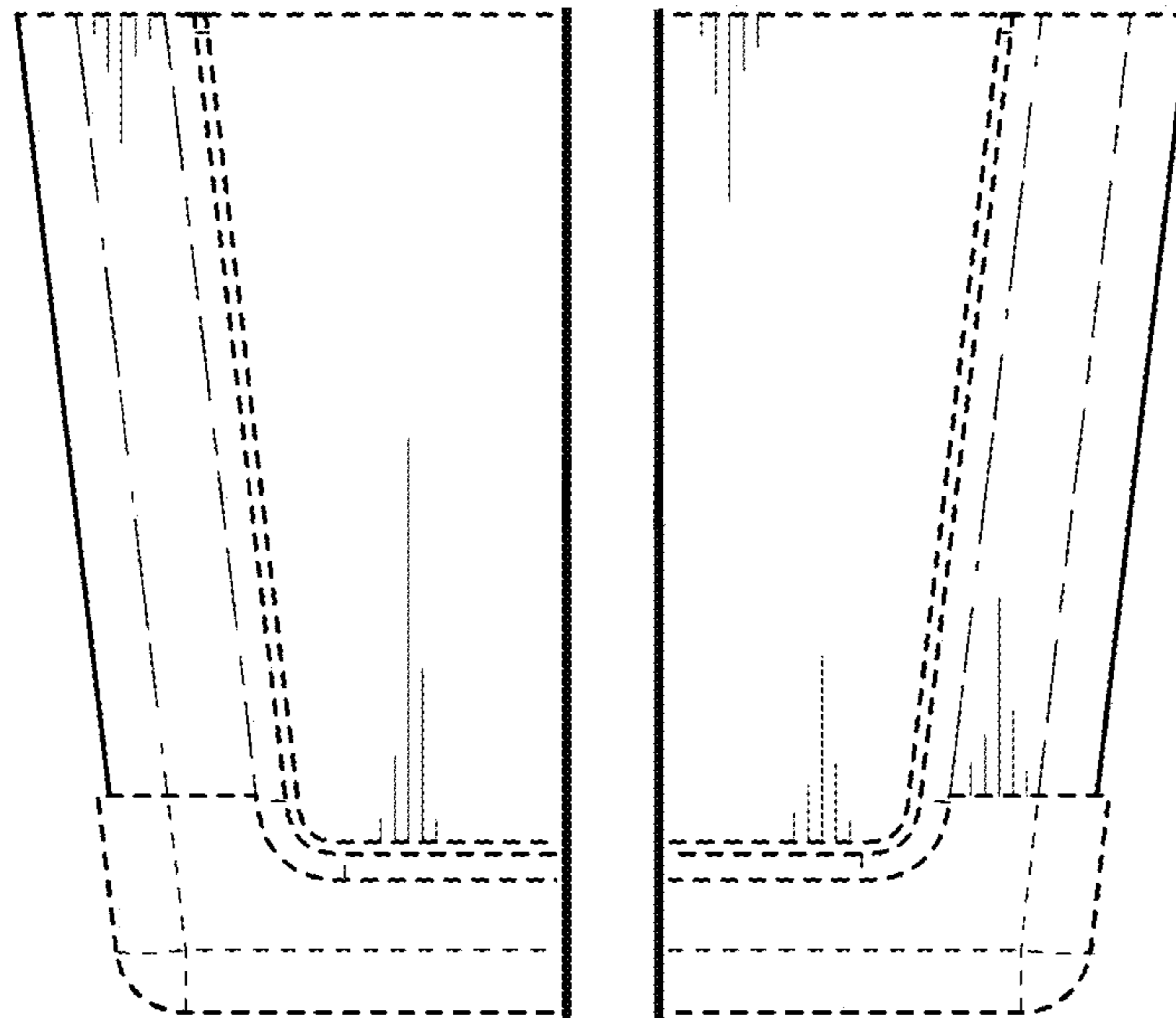

FIG. 16

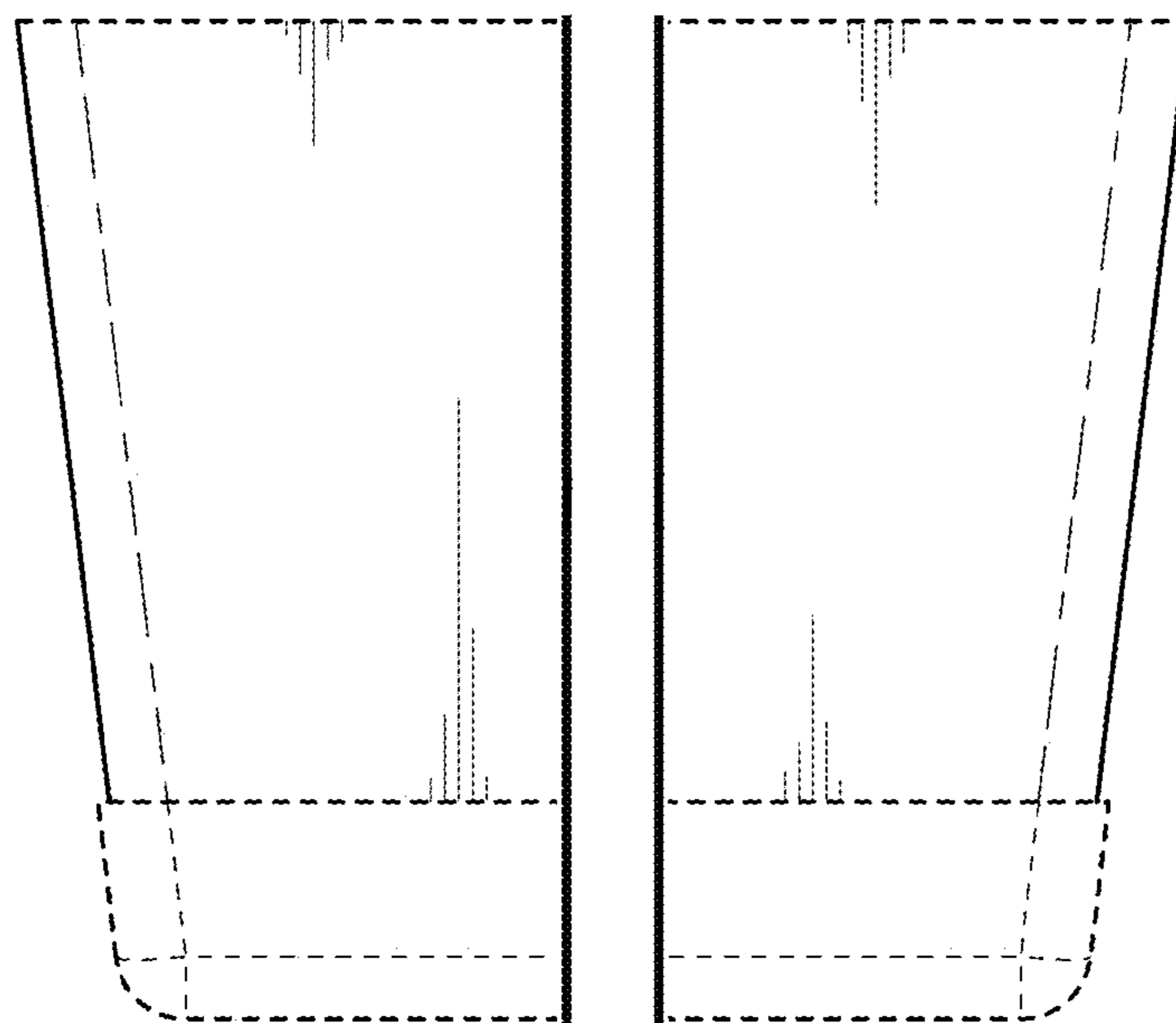

FIG. 17

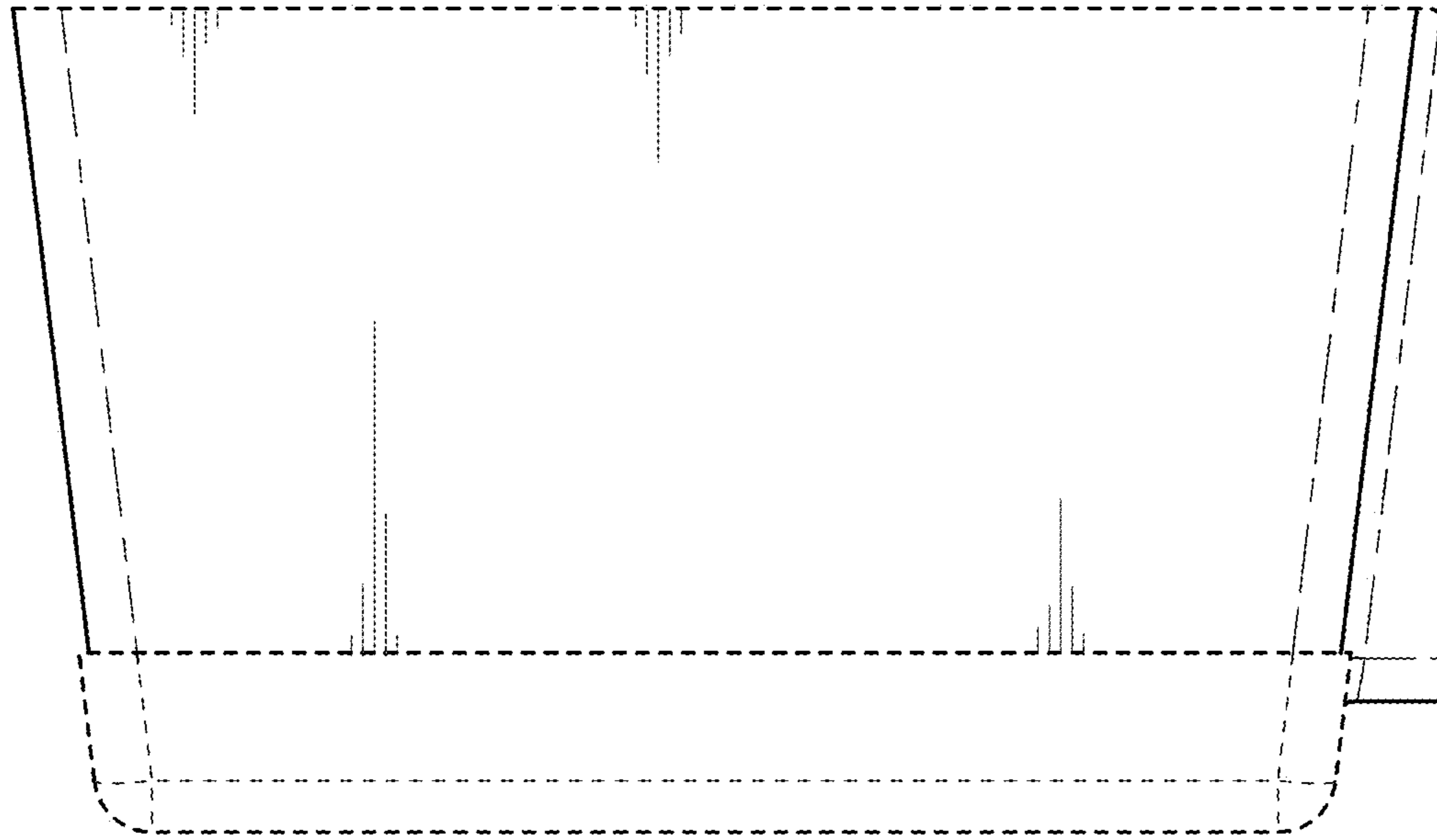

FIG. 18

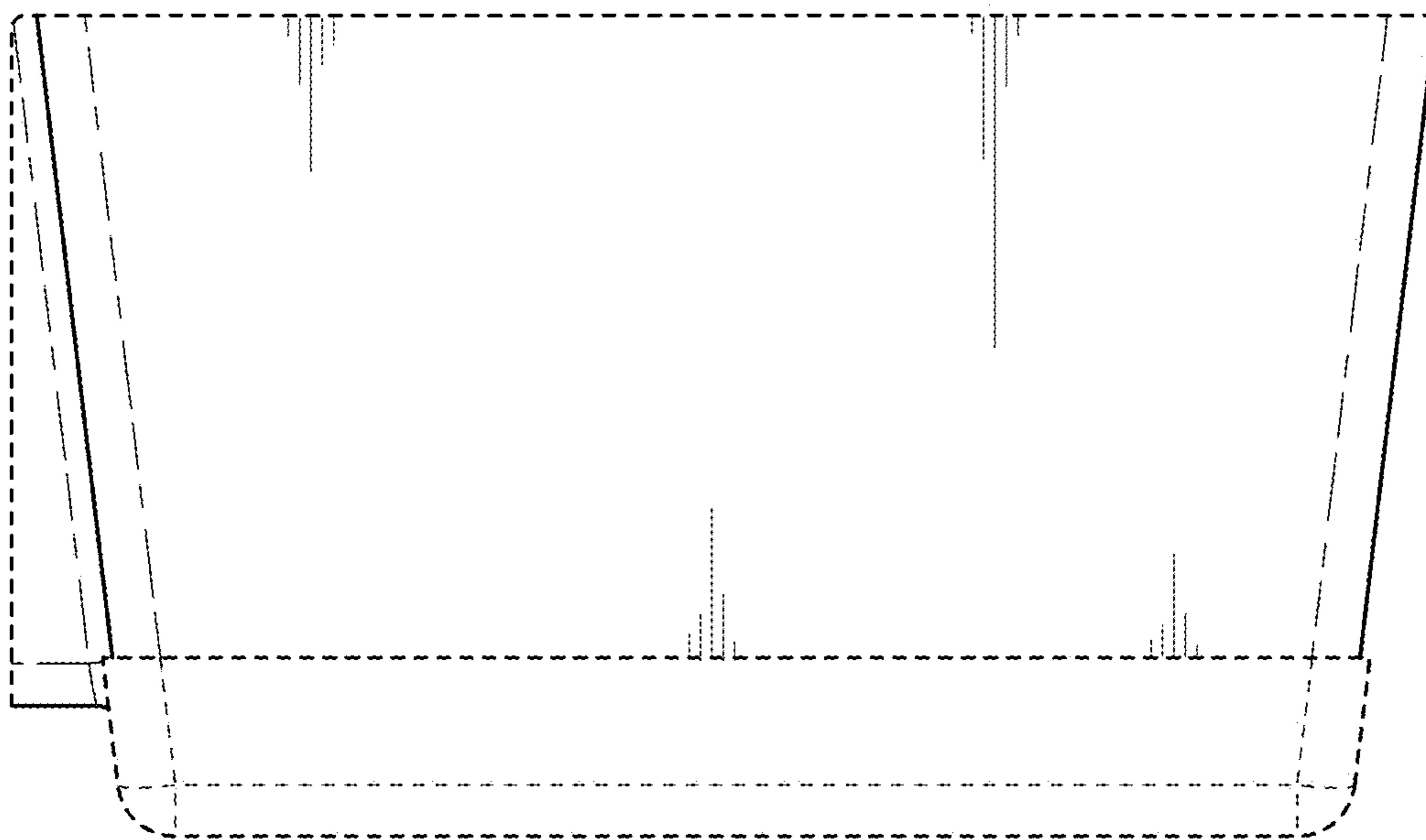

FIG. 19

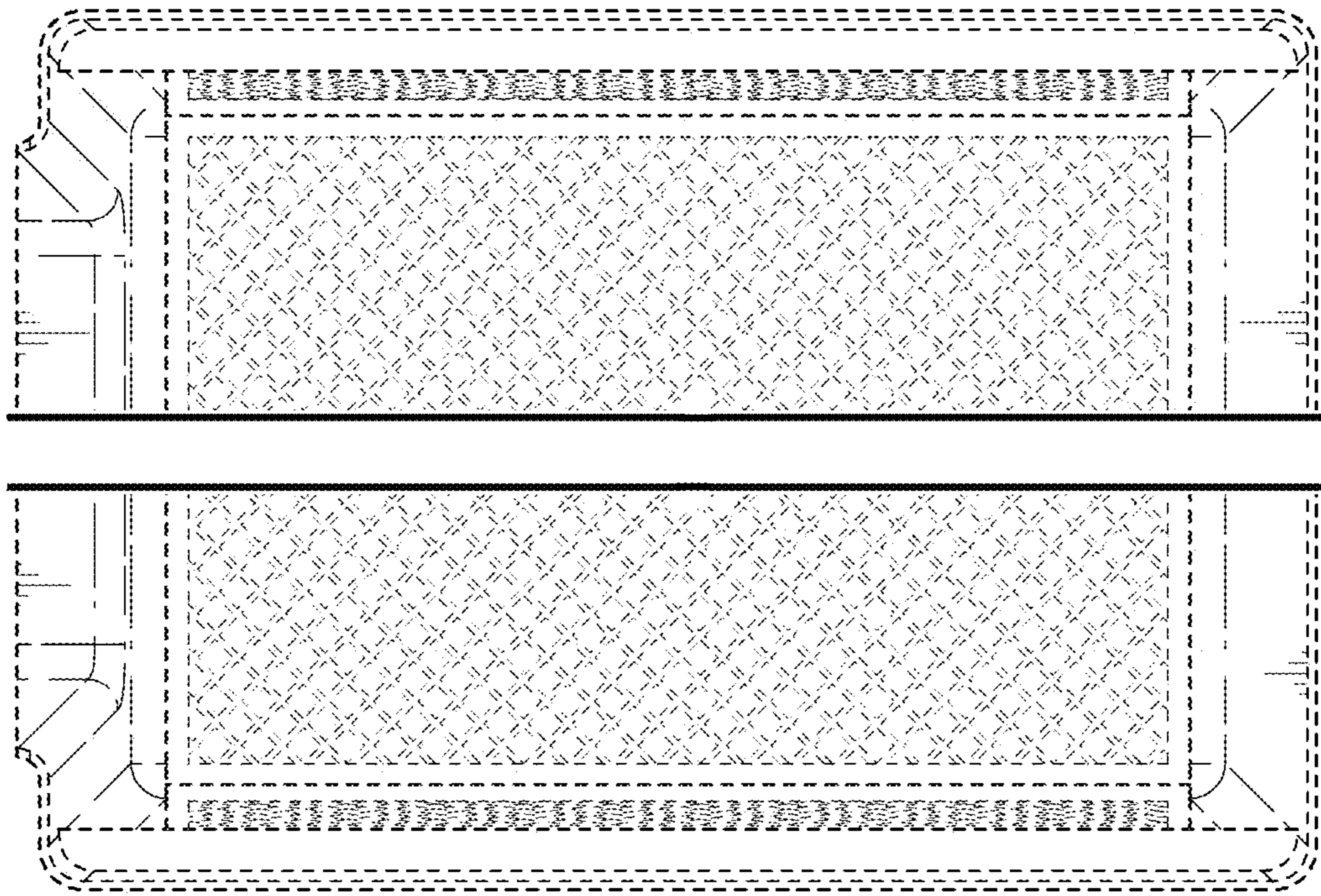

FIG. 20

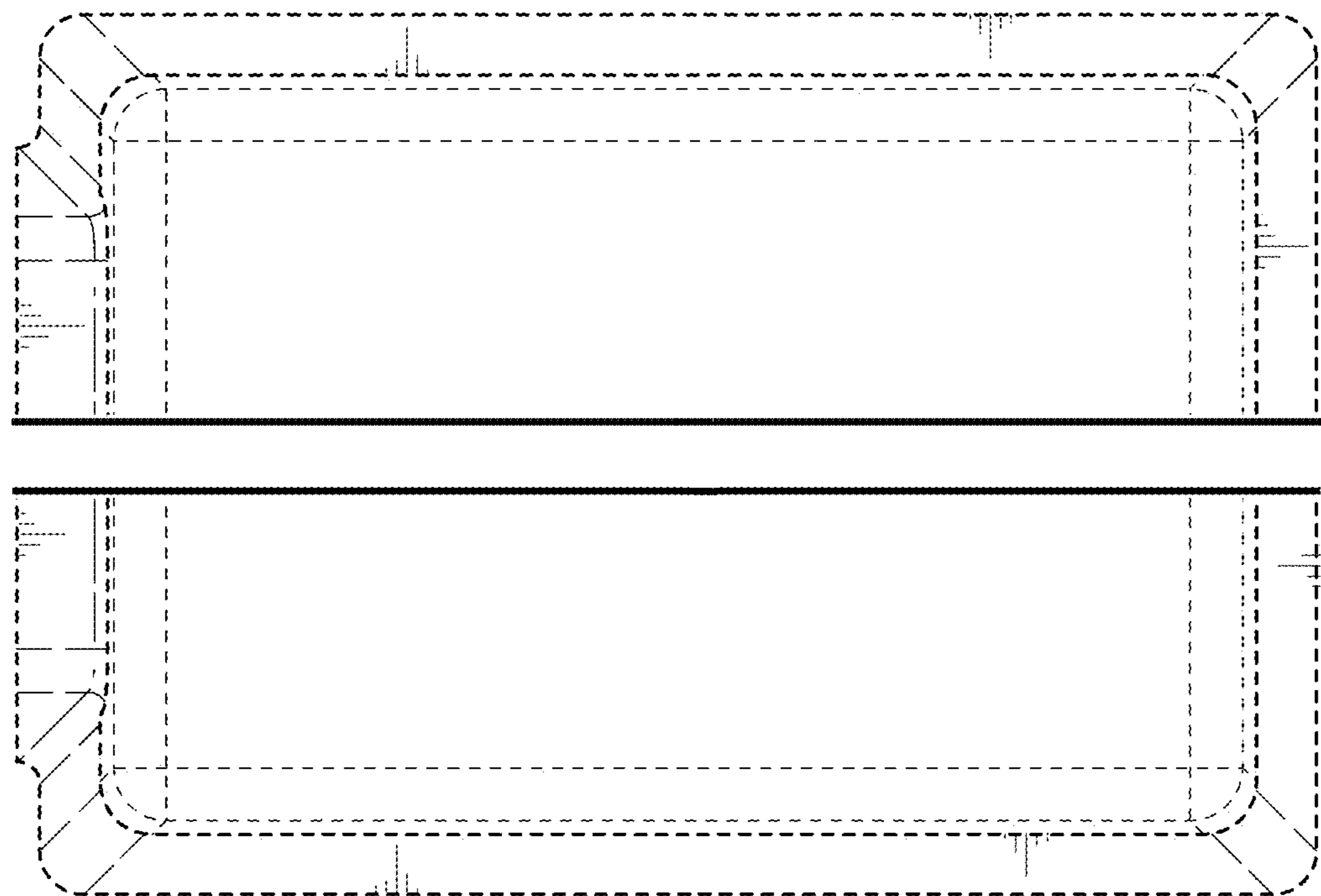

FIG. 21

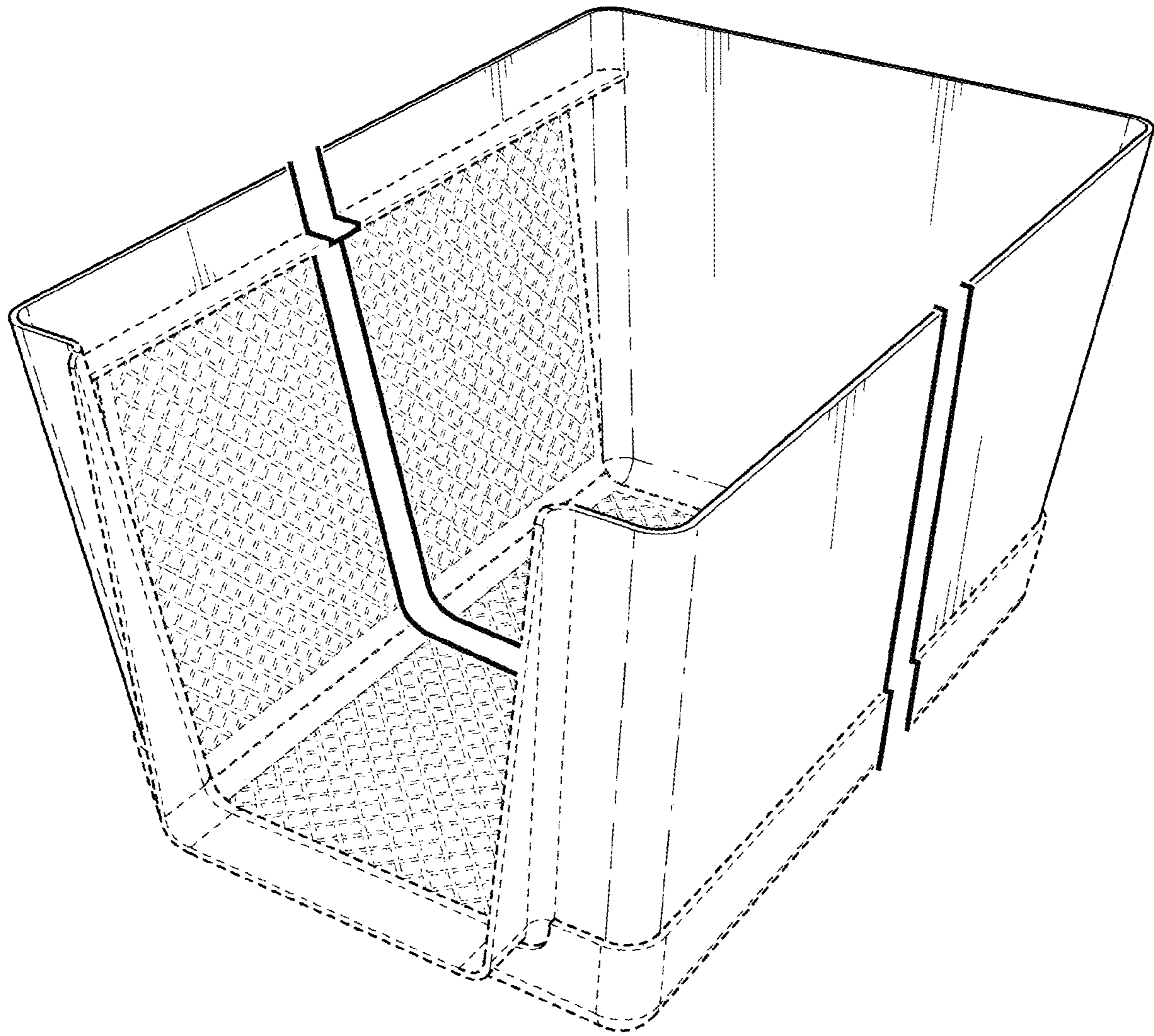

FIG. 22

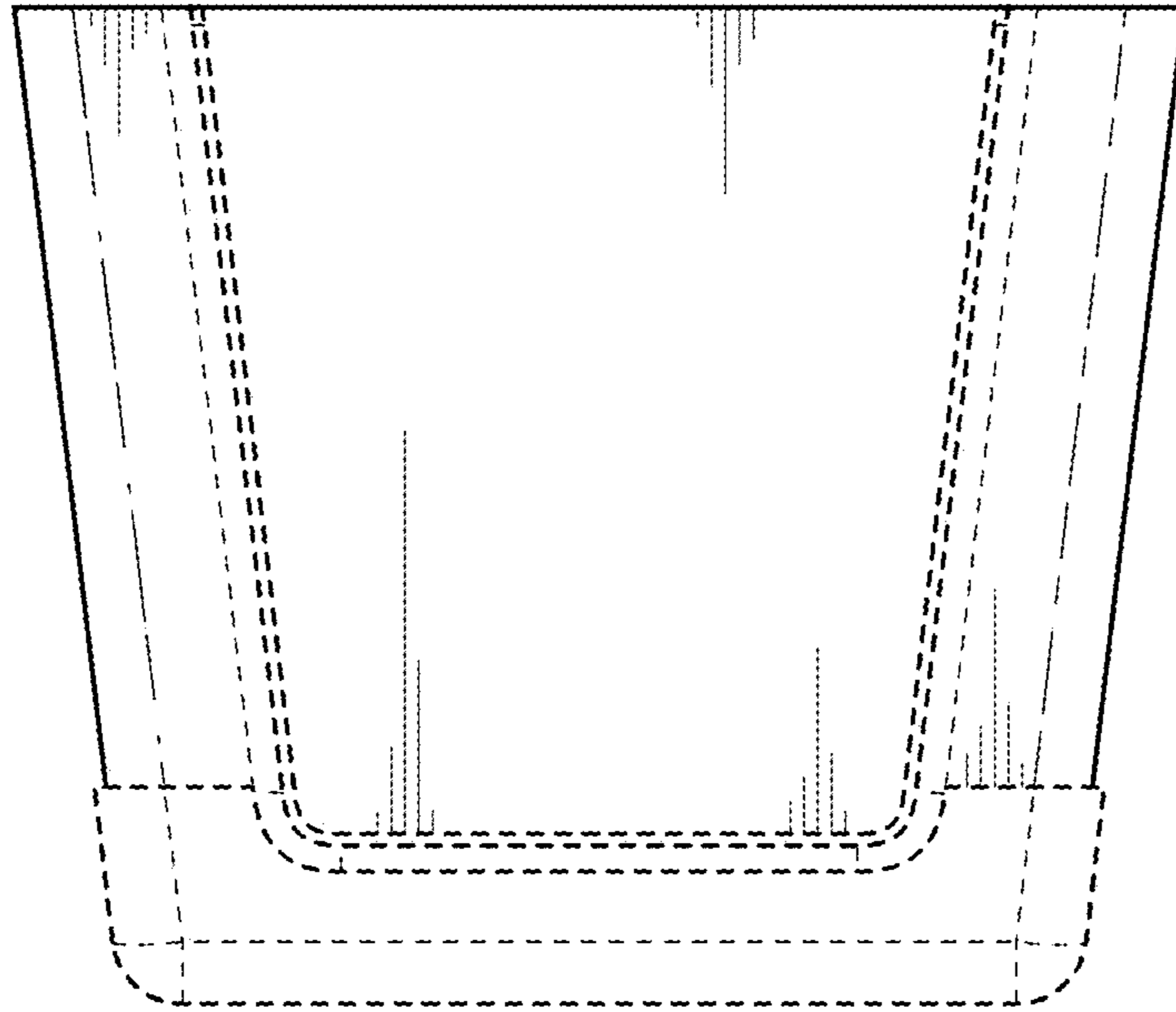

FIG. 23

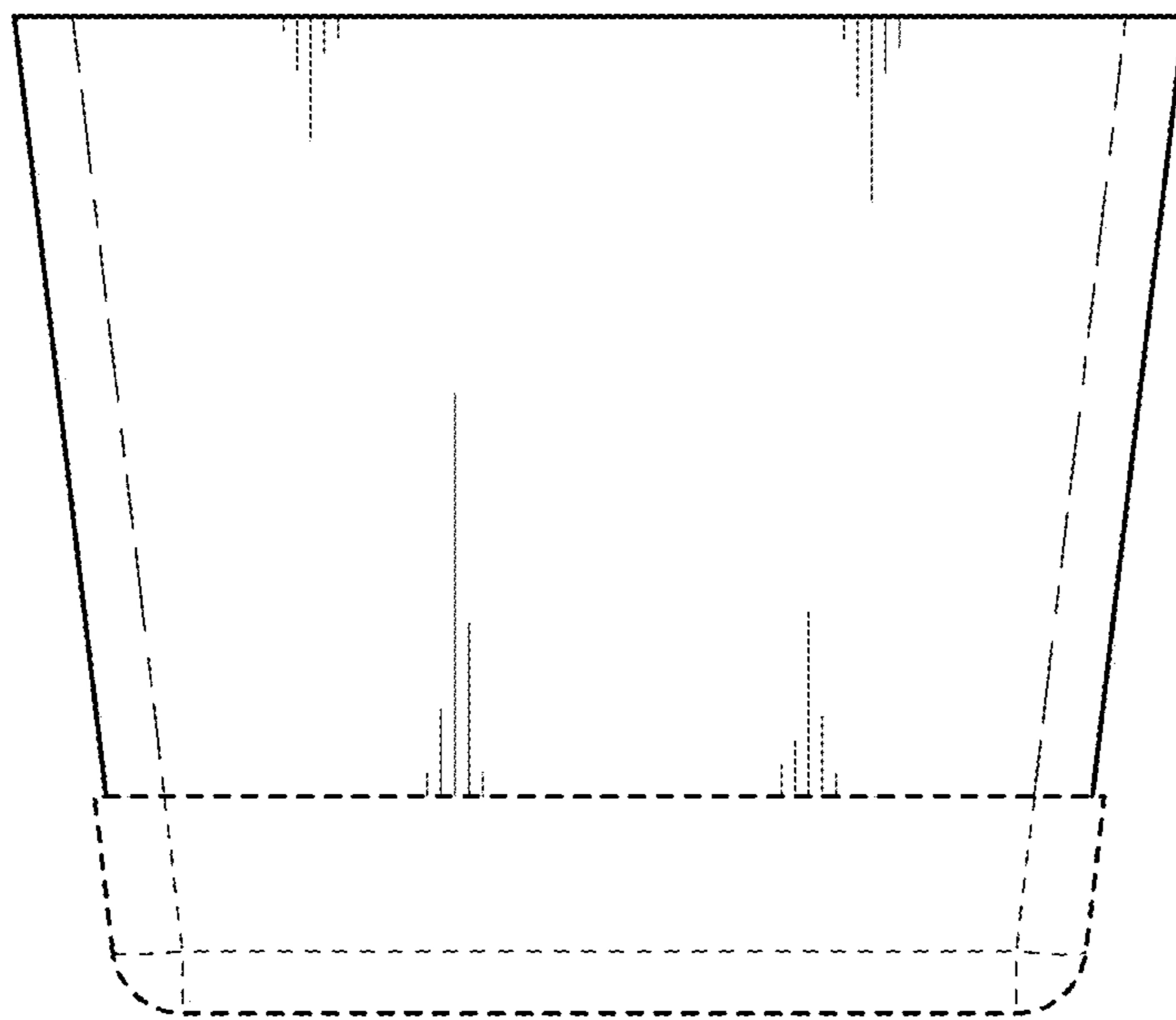

FIG. 24

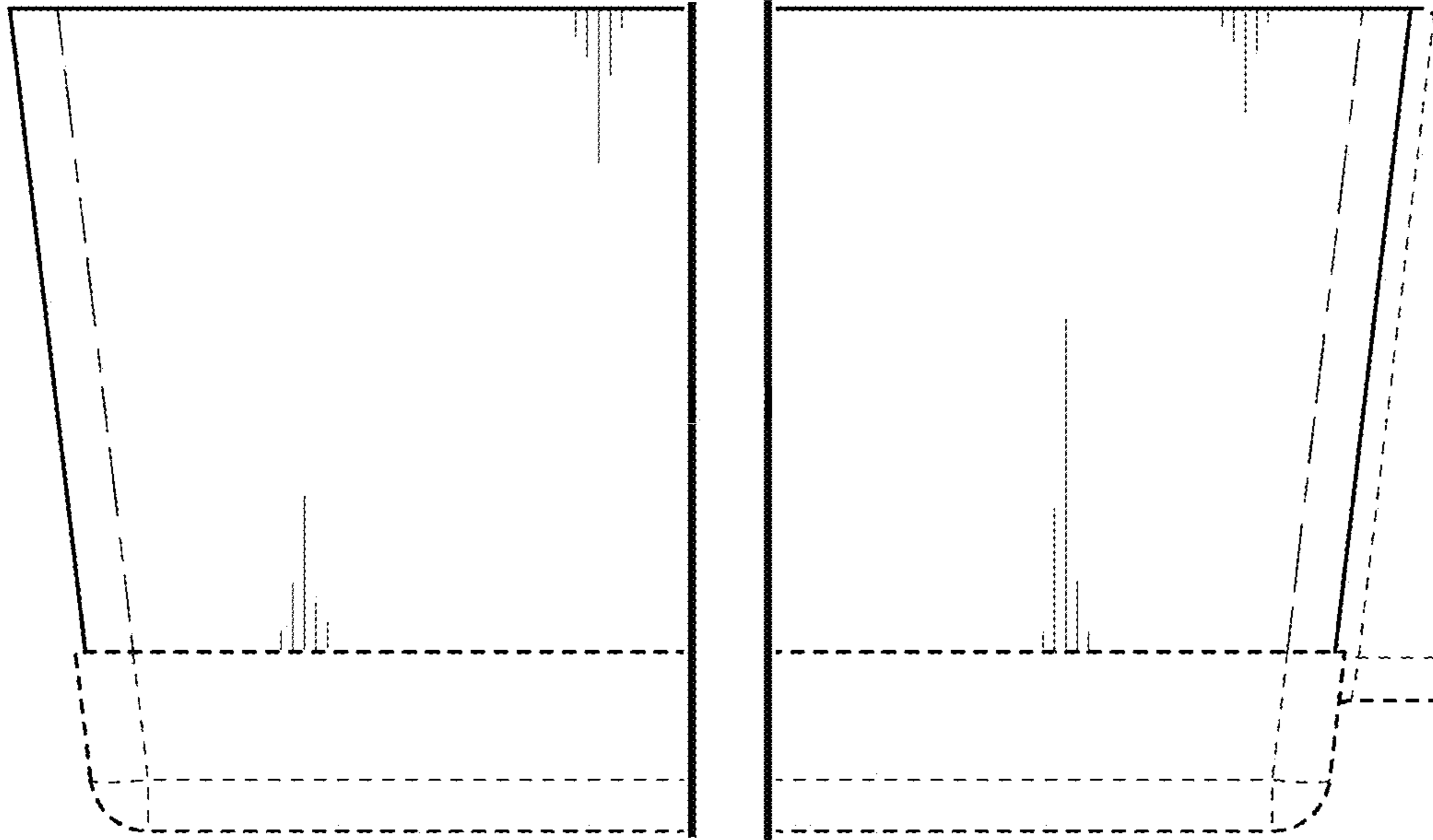

FIG. 25

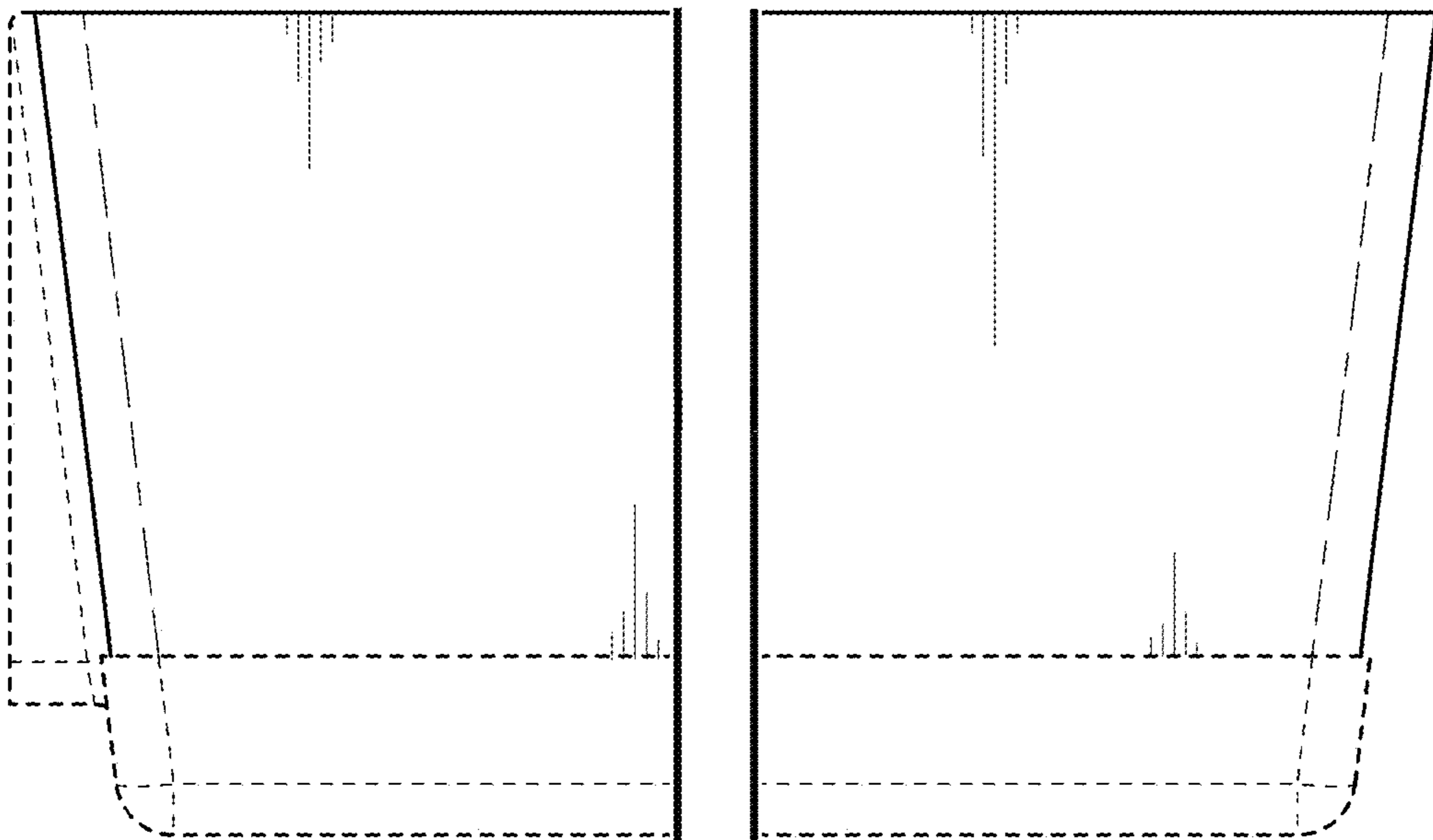

FIG. 26

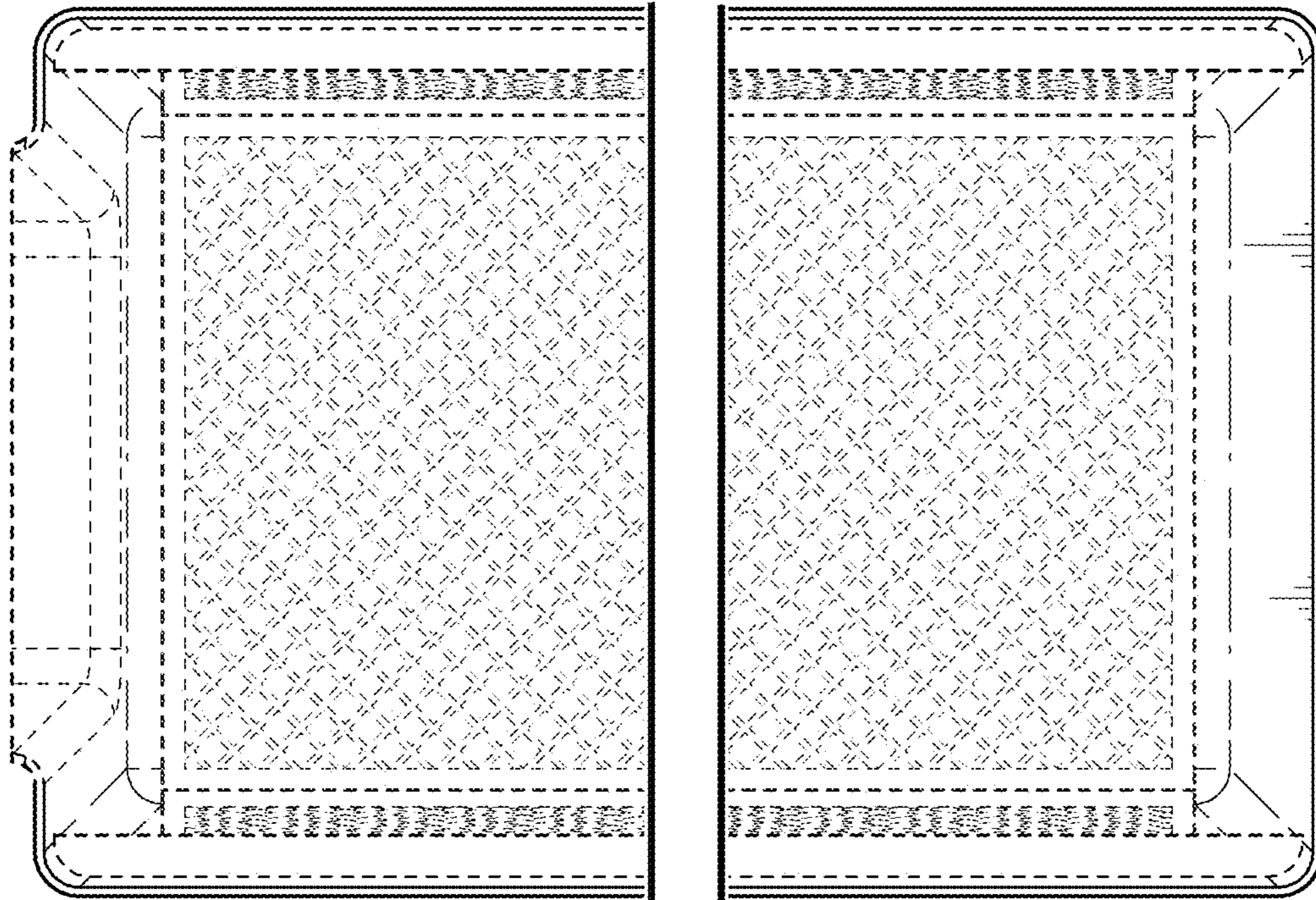

FIG. 27

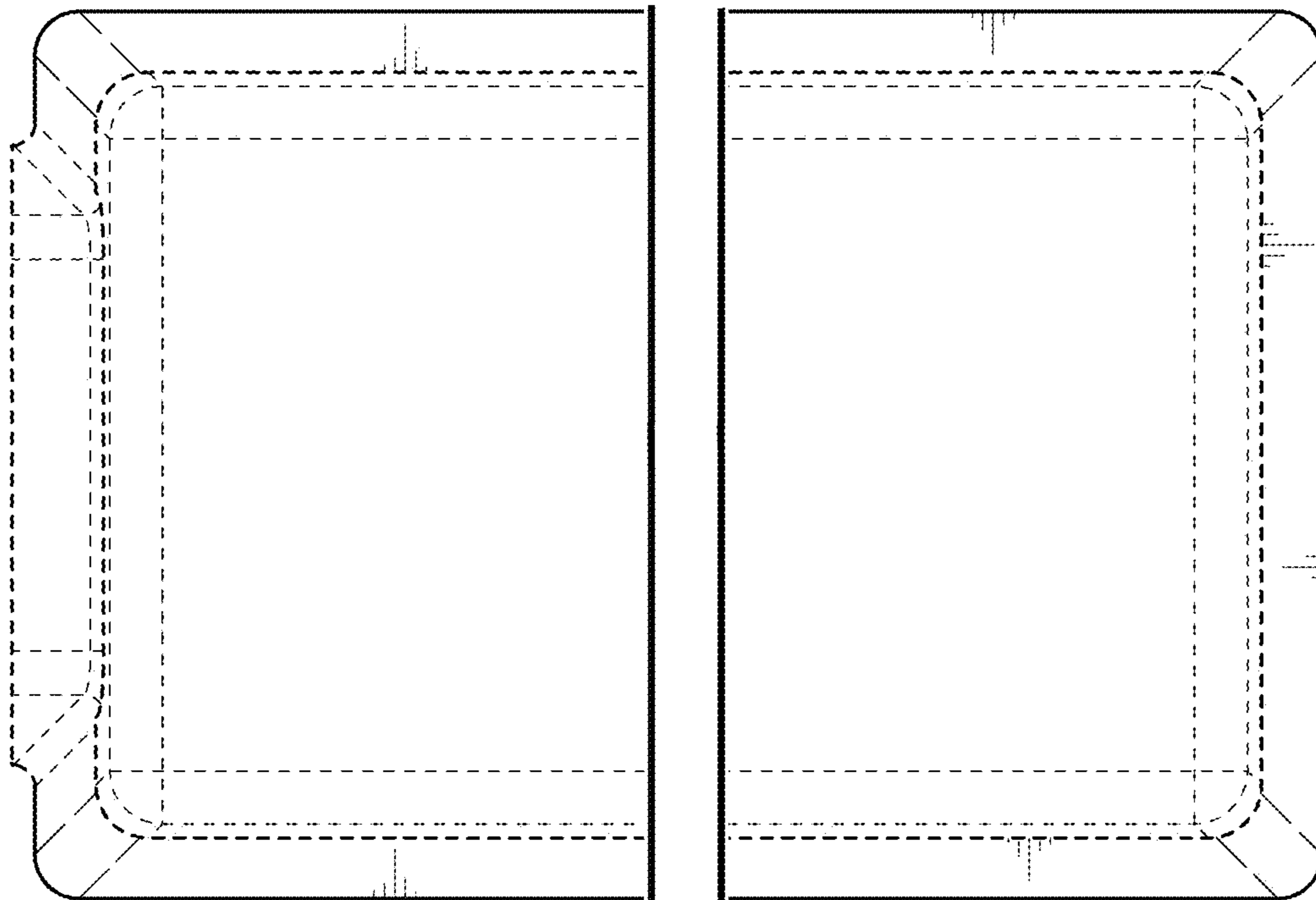

FIG. 28

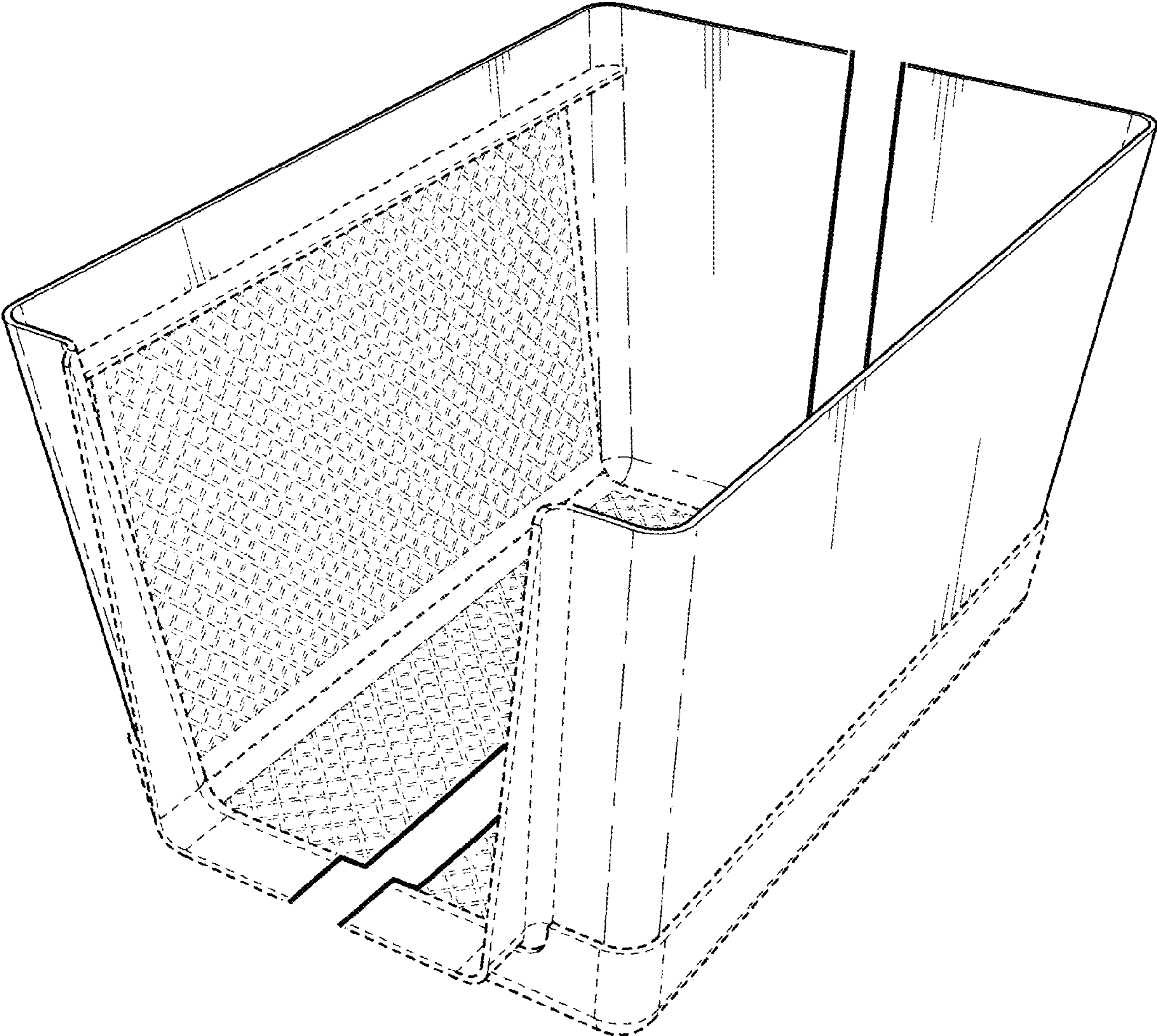

FIG. 29

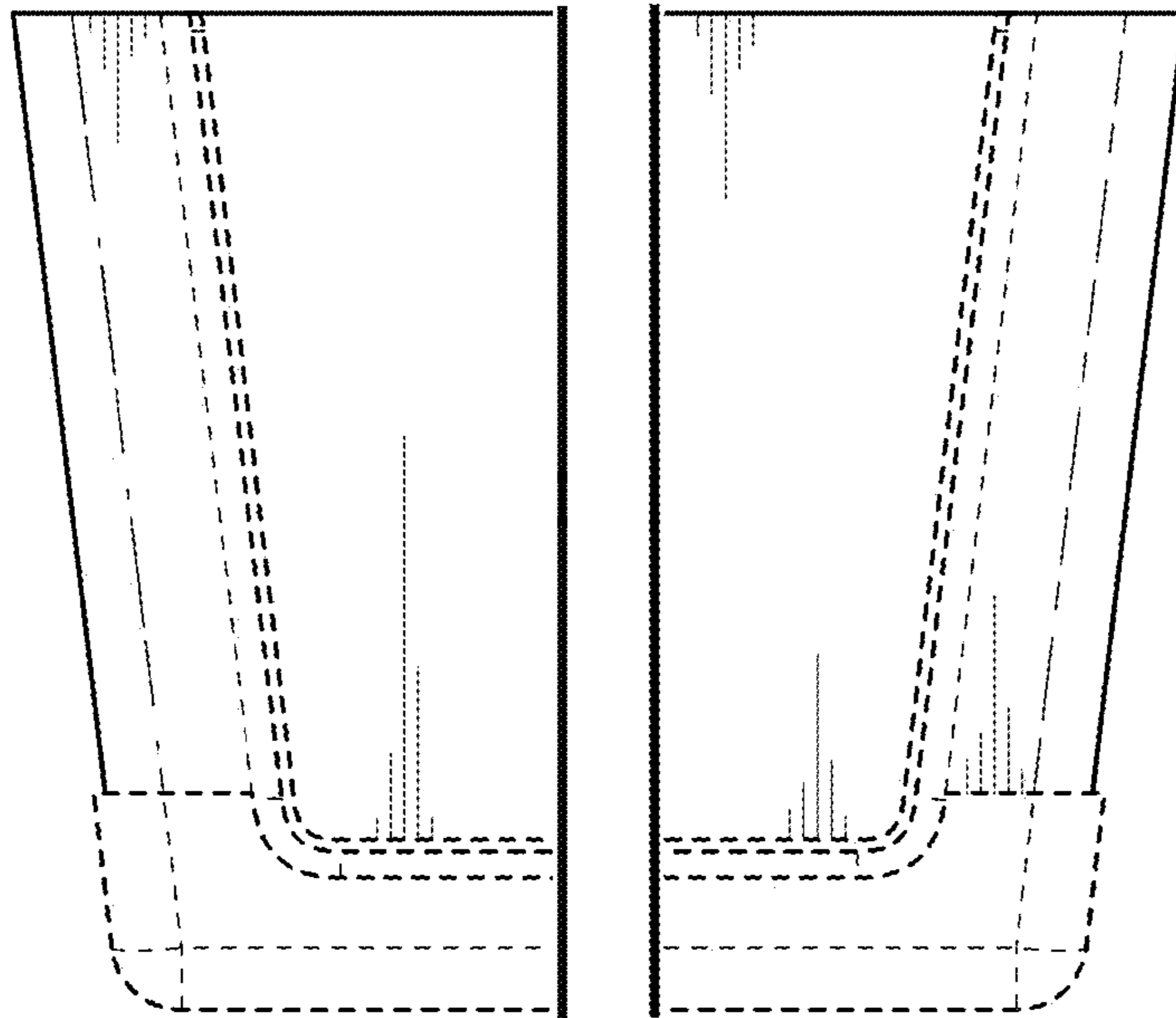

FIG. 30

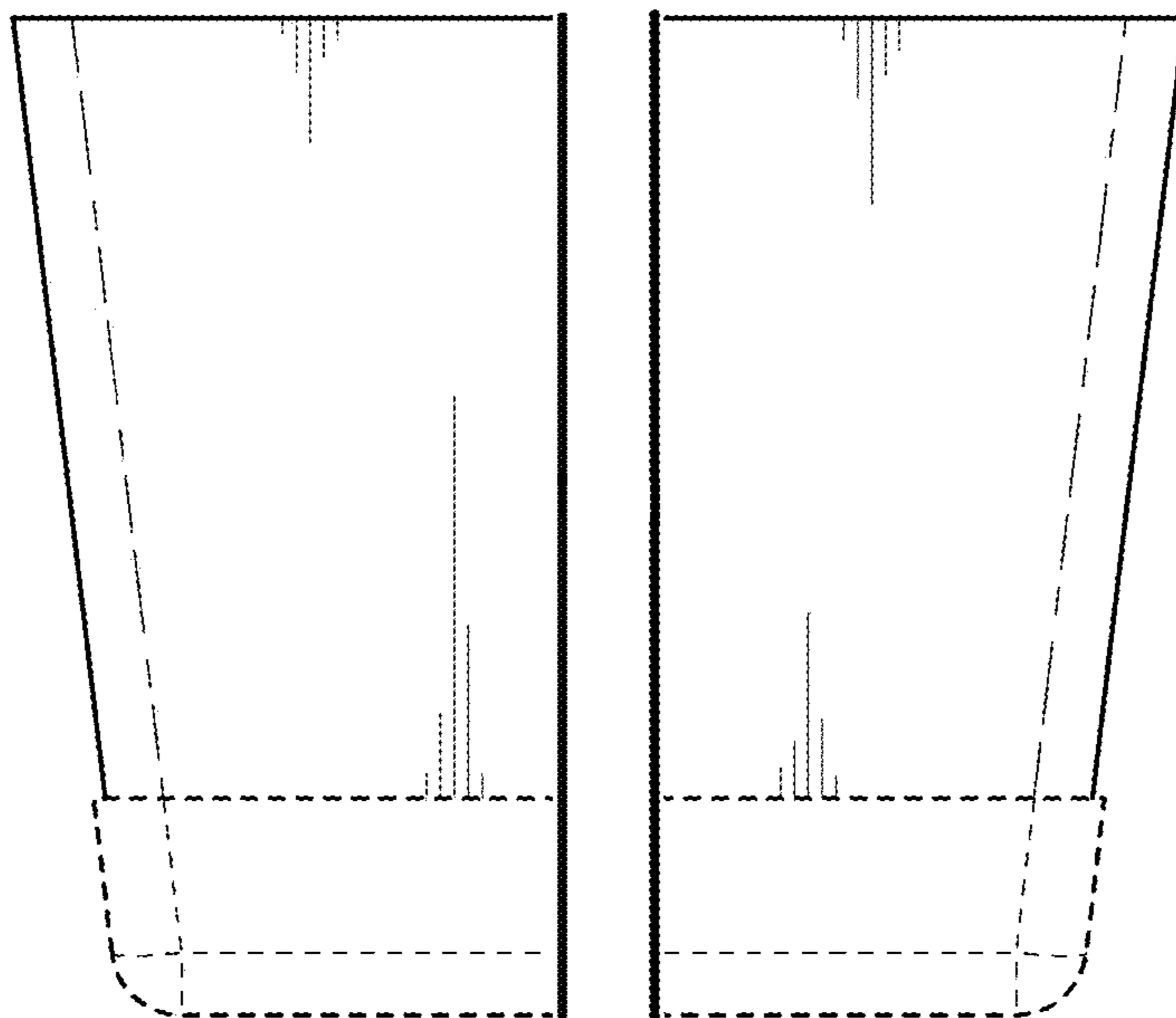

FIG. 31

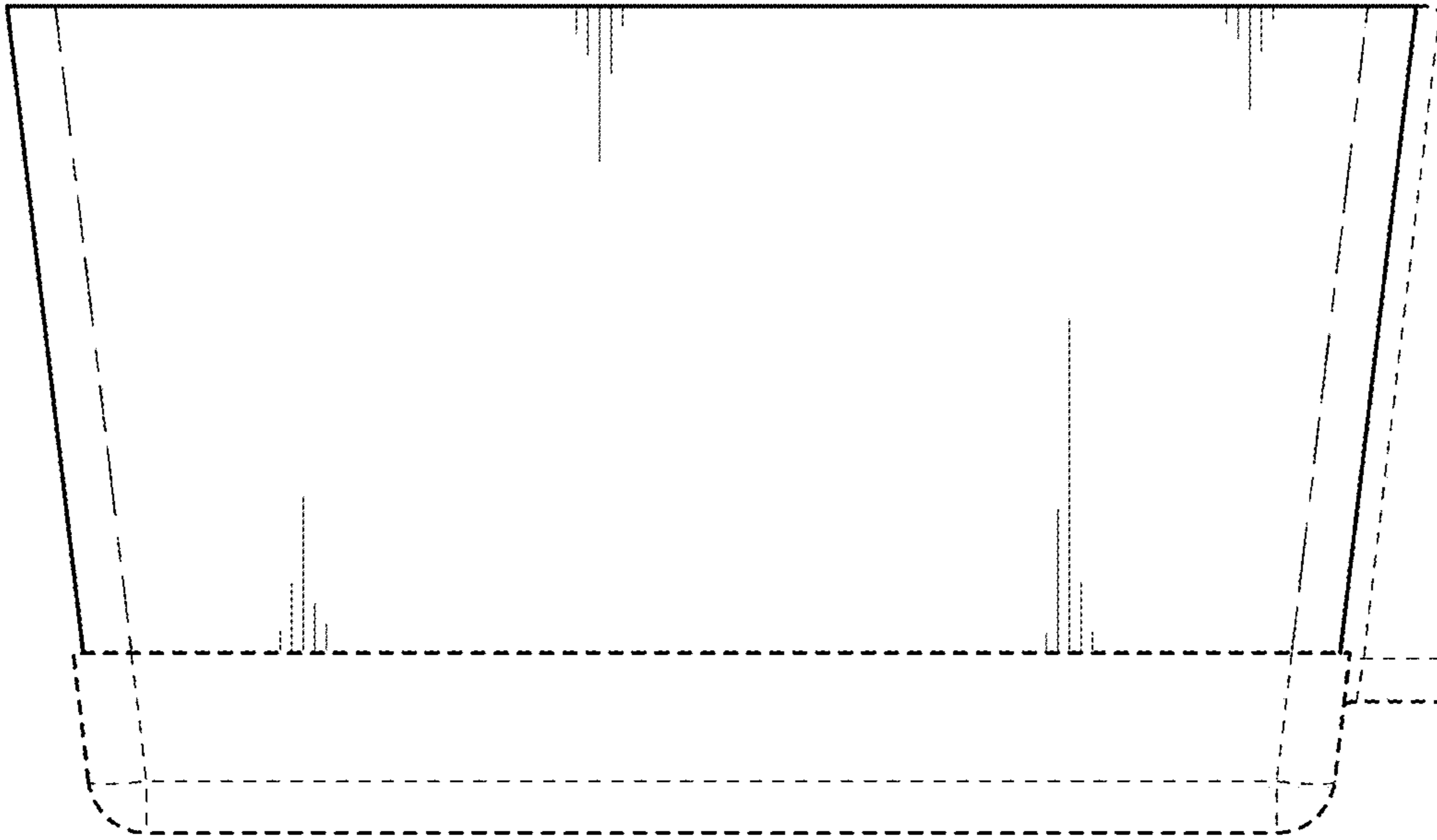

FIG. 32

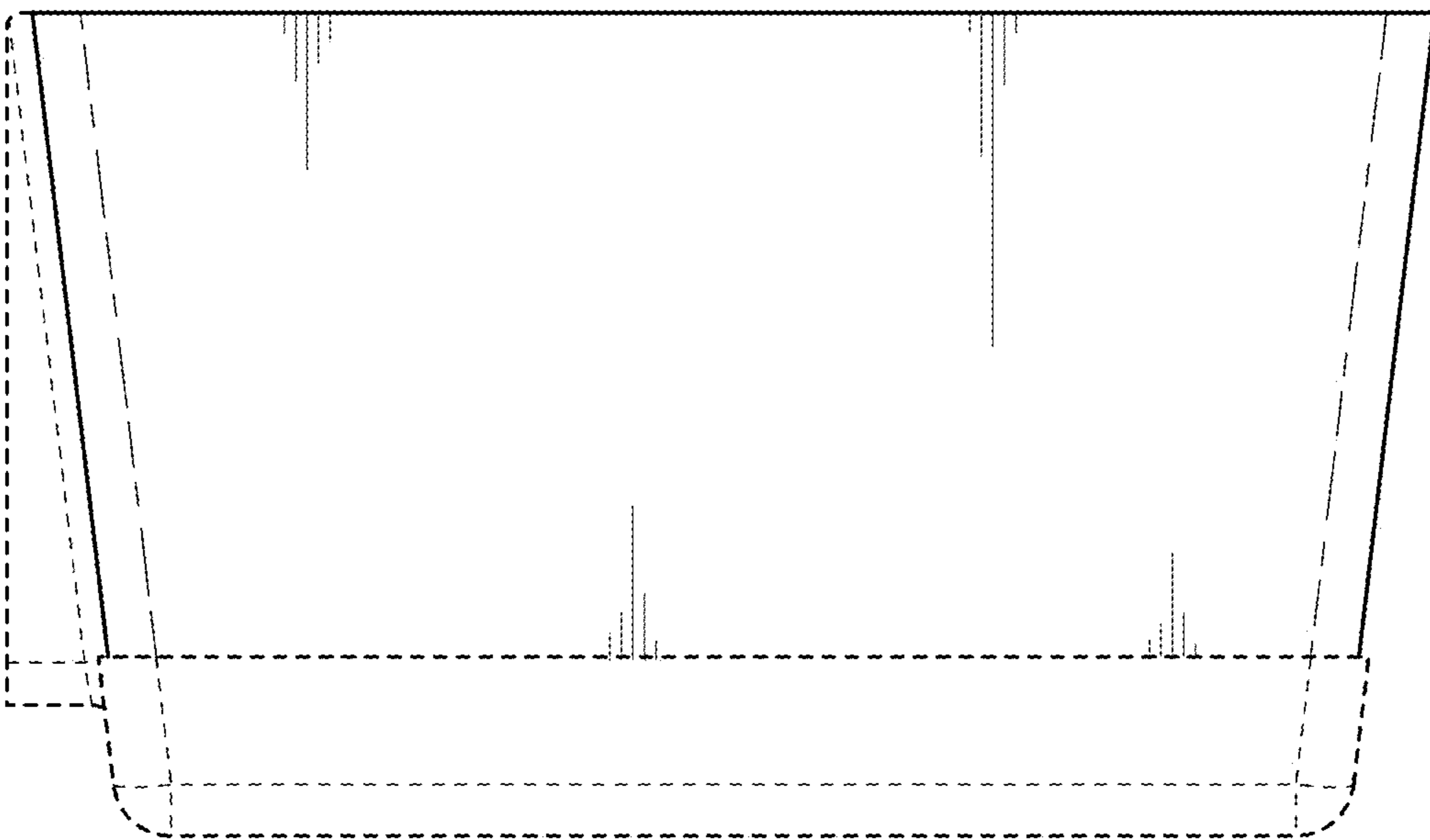

FIG. 33

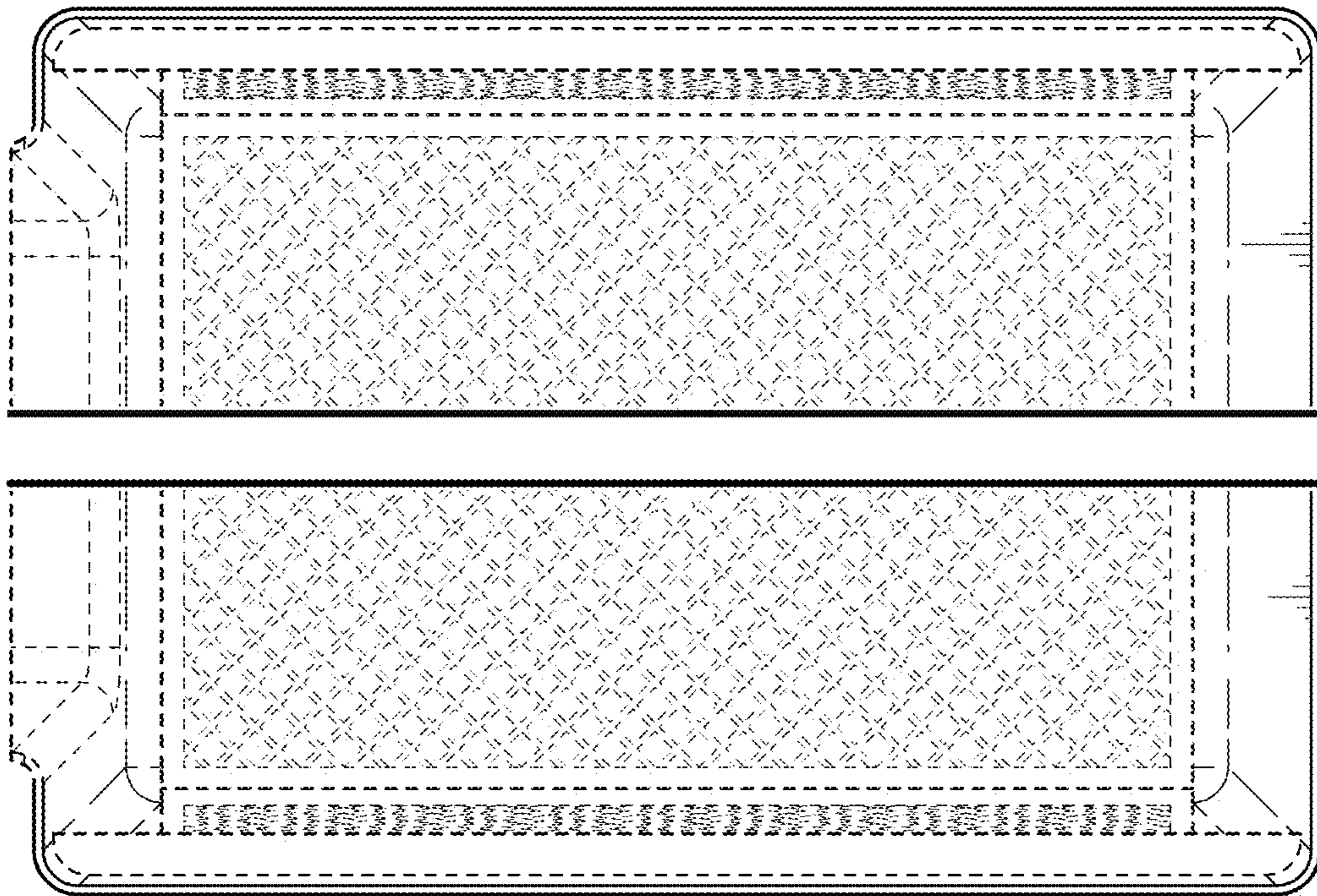

FIG. 34

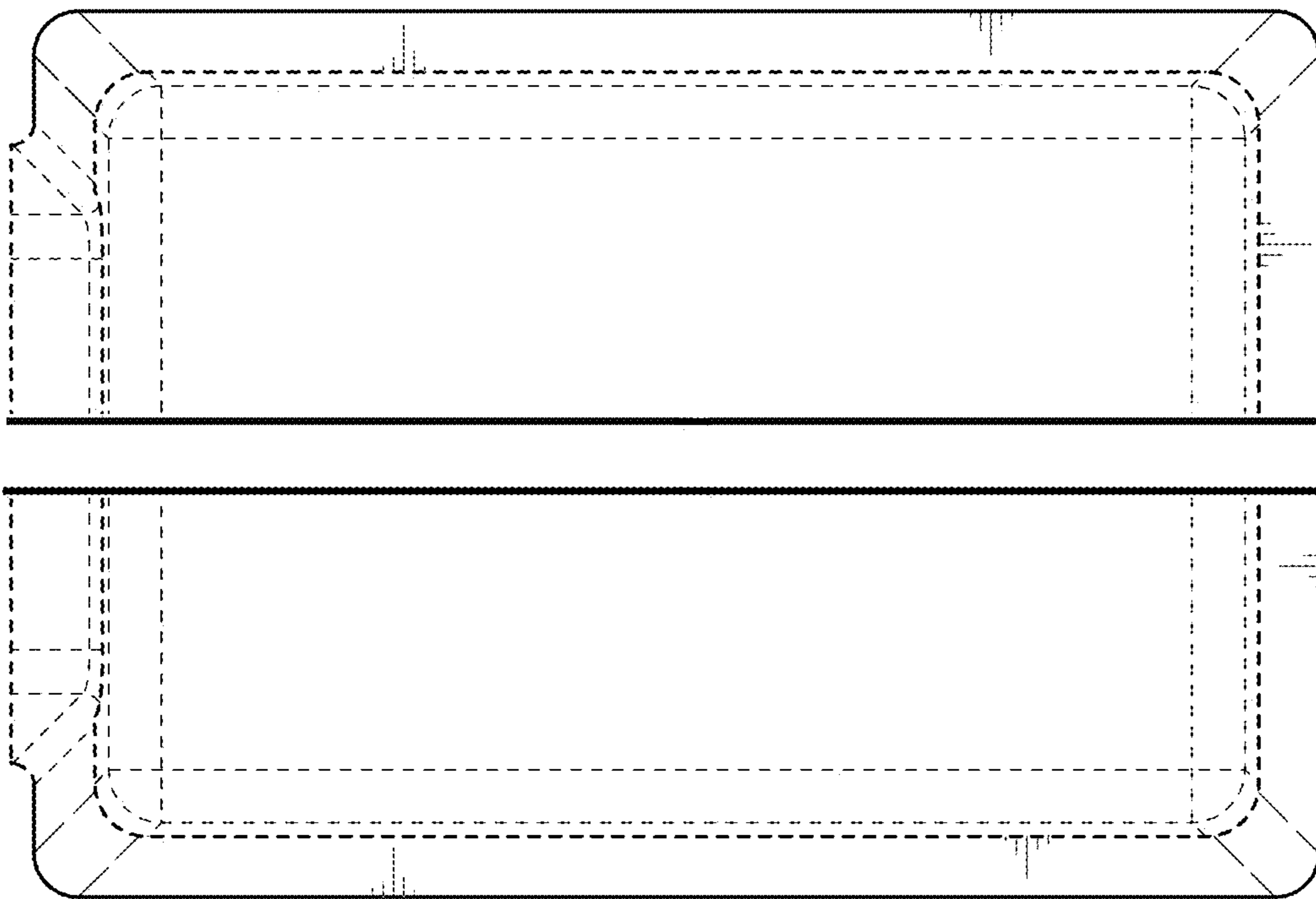

FIG. 35