



US00D942083S

(12) **United States Design Patent** (10) **Patent No.:** **US D942,083 S**
Goeder et al. (45) **Date of Patent:** **** Jan. 25, 2022**

(54) **HAIR REMOVAL DEVICE**
(71) Applicant: **Braun GmbH**, Kronberg (DE)
(72) Inventors: **Philipp Goeder**, Frankfurt (DE);
Gregor Ptok, Frankfurt (DE);
Bernhard Sikora, Kelkheim (DE);
Wolfgang Stegmann, Frankfurt (DE)
(73) Assignee: **Braun GMBH**, Kronberg (DE)
(**) Term: **15 Years**
(21) Appl. No.: **29/781,635**
(22) Filed: **Apr. 30, 2021**

D513,344 S * 12/2005 Choi D28/53
D567,446 S 4/2008 Hara et al.
D586,955 S * 2/2009 Eigenstetter D28/53
D604,907 S * 11/2009 Emminger D28/53
D628,745 S 12/2010 Dingelstad
D648,895 S 11/2011 Ino
D649,290 S 11/2011 Ino
D657,912 S 4/2012 Yoon
D689,242 S 9/2013 Grabes et al.
D690,880 S 10/2013 Grabes et al.
D696,458 S 12/2013 Ino
D698,084 S * 1/2014 Yoon D28/53
D698,492 S * 1/2014 Grabes D28/53
D711,594 S 8/2014 Palmer et al.
D713,994 S 9/2014 Grabes et al.

(Continued)

Related U.S. Application Data

(62) Division of application No. 29/709,111, filed on Oct. 11, 2019, now Pat. No. Des. 921,985, which is a division of application No. 29/598,471, filed on Mar. 27, 2017, now Pat. No. Des. 868,377.

Foreign Application Priority Data

Sep. 28, 2016 (WO) 968861101
Nov. 10, 2016 (WO) 1336501

(51) **LOC (13) Cl.** **28-03**
(52) **U.S. Cl.**
USPC **D28/53**; D28/51
(58) **Field of Classification Search**
USPC D28/49, 51, 53, 54
CPC .. B26B 19/3853-3866; B26B 19/3886; B26B
19/20; B26B 19/205; B26B 19/22; B26B
19/00-107
See application file for complete search history.

References Cited

U.S. PATENT DOCUMENTS

D356,185 S * 3/1995 Rizzuto, Jr. D28/53
D454,980 S * 3/2002 Long D28/53

OTHER PUBLICATIONS

<https://www.amazon.com/Braun-Trimmer-Cordless-Rechargeable-Clipper/dp/B07XZSN2N3?th=1> Braun Beard Trimmer BT3221, reviewed as early as May 2020, 1 page (Year: 2020).*

(Continued)

Primary Examiner — Jennifer Rivard

(74) *Attorney, Agent, or Firm* — Brigitte Grab; Kevin C. Johnson

CLAIM

(57) The ornamental design for a hair removal device, as shown and described.

DESCRIPTION

FIG. 1 is a perspective view of a hair removal device;
FIG. 2 is a front view thereof;
FIG. 3 is a left side view thereof;
FIG. 4 is a rear view thereof;
FIG. 5 is a right side view thereof;
FIG. 6 is a top plan view thereof; and,
FIG. 7 is a bottom view thereof.

1 Claim, 1 Drawing Sheet

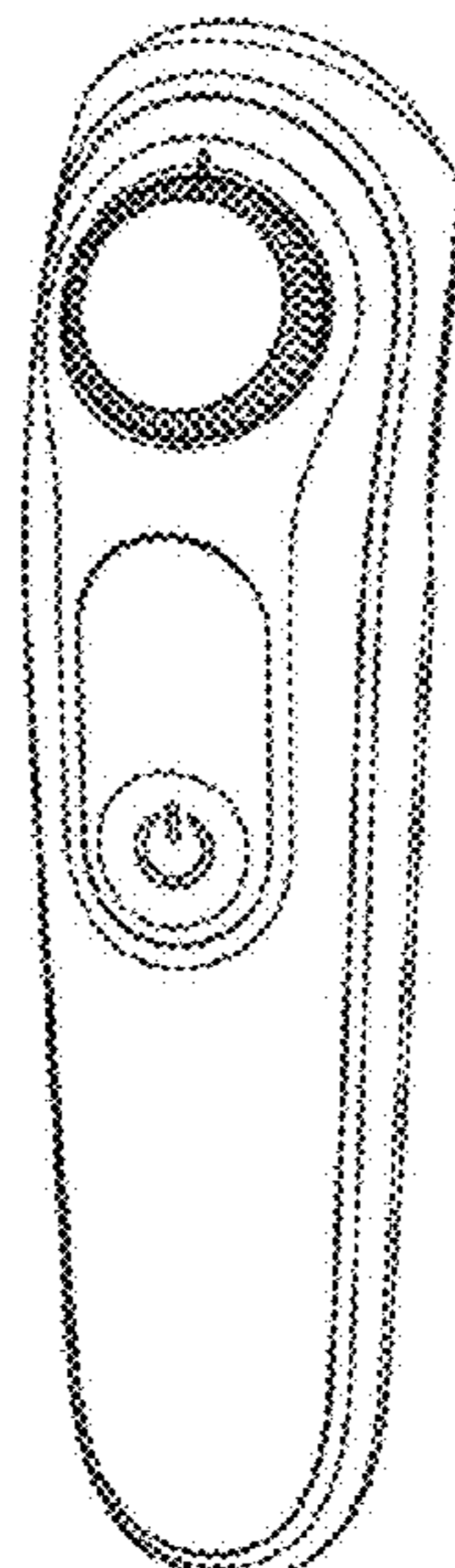

(56)

References Cited

U.S. PATENT DOCUMENTS

D717,996 S 11/2014 Kikuchi
 D722,199 S 2/2015 Boulanger
 D724,271 S 3/2015 Giannini
 D733,358 S 6/2015 Palmer et al.
 D751,252 S 3/2016 Grabes et al.
 D752,811 S 3/2016 Okabe et al.
 D753,342 S 4/2016 Okabe
 D756,565 S 5/2016 Andersson
 D760,437 S * 6/2016 Emminger D28/53
 D763,509 S 8/2016 Teteak et al.
 D767,207 S 9/2016 Dekliein
 D768,391 S 10/2016 Kling et al.
 D771,315 S * 11/2016 Andersson D28/53
 D781,588 S 3/2017 Lee
 D784,618 S * 4/2017 Mori D28/53
 D799,118 S 10/2017 Ino
 D800,965 S * 10/2017 Aulwes D28/53
 D802,214 S 11/2017 Mintz et al.
 D804,189 S 12/2017 Von Berg
 D813,457 S 3/2018 Okabe et al.
 D813,458 S 3/2018 Okabe et al.
 D819,338 S 6/2018 Xiong
 10,080,428 B2 9/2018 Kern
 D829,445 S 10/2018 Kern
 D851,835 S * 6/2019 Gross D28/53
 D853,648 S * 7/2019 Boulanger D28/53
 D866,072 S * 11/2019 Chen D28/53
 D866,861 S 11/2019 Dawson et al.

D867,663 S * 11/2019 Boulanger D28/53
 D868,377 S 11/2019 Goeder et al.
 10,486,316 B2 11/2019 Erndt et al.
 10,486,318 B2 11/2019 Bady et al.
 D872,366 S * 1/2020 Cociffi D28/53
 D879,377 S 3/2020 Dawson et al.
 D883,573 S * 5/2020 Cociffi D28/53
 10,702,999 B2 7/2020 Iaccarino et al.
 D905,909 S * 12/2020 Wang D28/53
 D908,962 S * 1/2021 Tran D28/51
 2006/0010630 A1 1/2006 Tse
 2012/0192436 A1 8/2012 Toy
 2013/0023806 A1 1/2013 Ungemach et al.
 2013/0097871 A1 4/2013 Yamaguchi et al.
 2015/0314461 A1 11/2015 Man Wong et al.
 2016/0031099 A1 2/2016 Provolo et al.
 2016/0176058 A1 6/2016 Piesker et al.
 2018/0085940 A1 3/2018 Krauss et al.
 2018/0085945 A1 3/2018 Bady et al.
 2018/0092449 A1 4/2018 Straka et al.
 2018/0311842 A1 11/2018 Kraus et al.
 2018/0319026 A1 11/2018 Hayashi et al.

OTHER PUBLICATIONS

Kemei Dry Shaver Brush, www.cdn.shopify.com, 1 page, downloaded Dec. 2018 (Year: 2018).
 Philips Series 7000, www.philips.co.uk, 1 page, downloaded Dec. 2018 (Year: 2018).

* cited by examiner

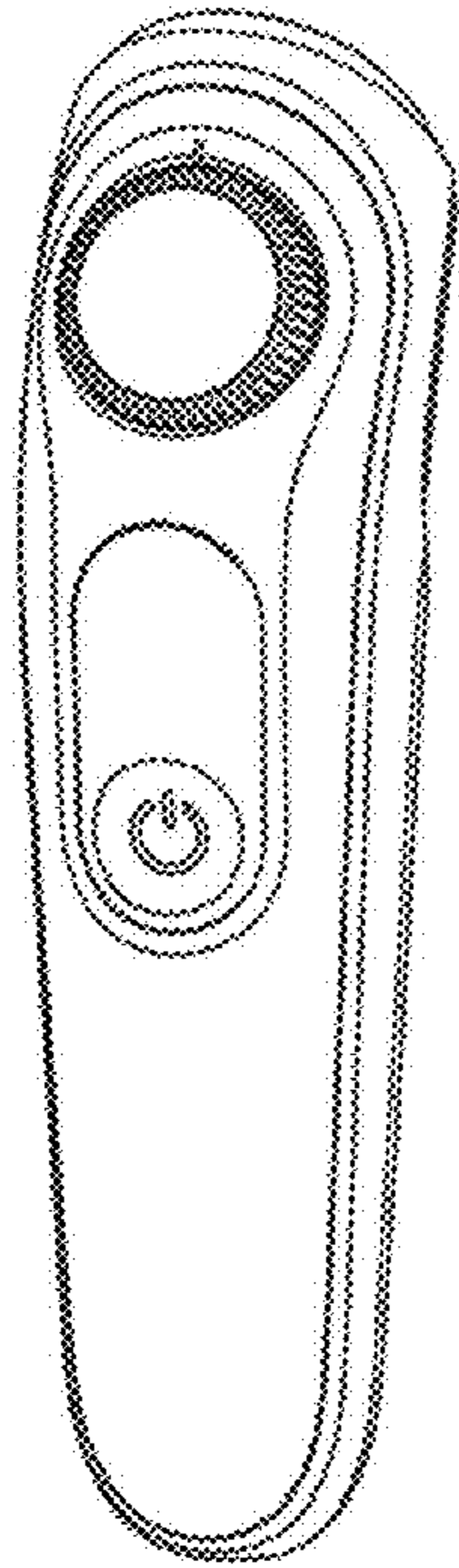

Fig. 1

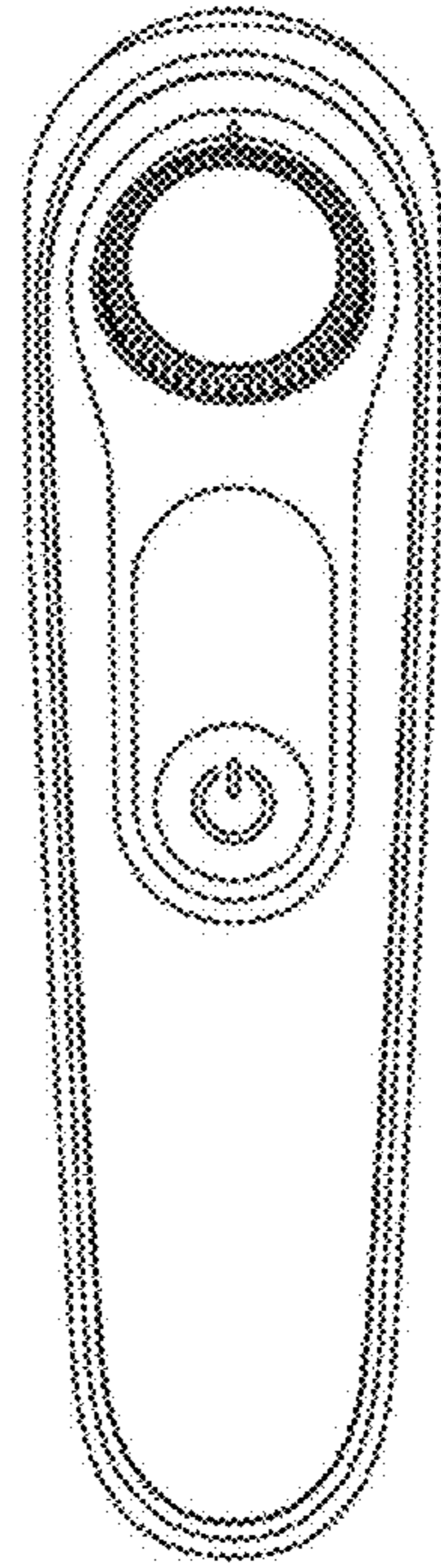

Fig. 2

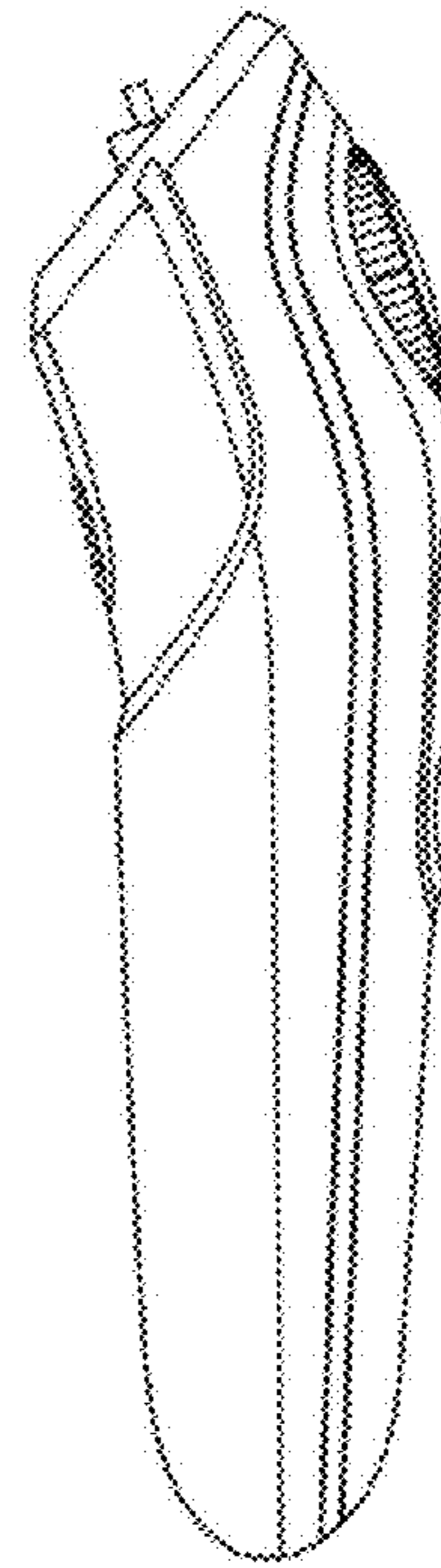

Fig. 3

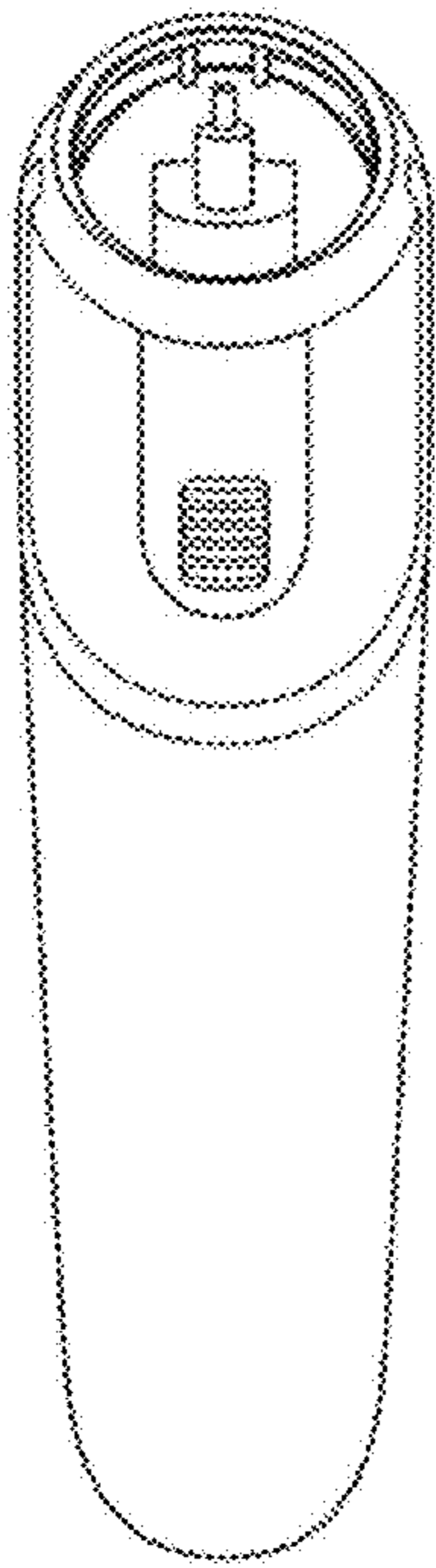

Fig. 4

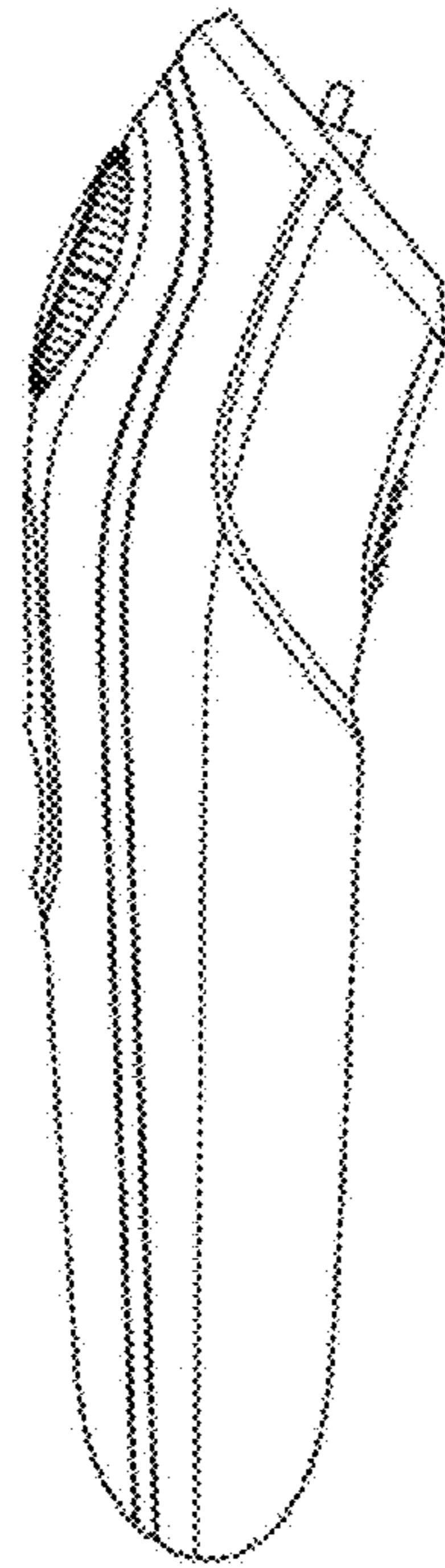

Fig. 5

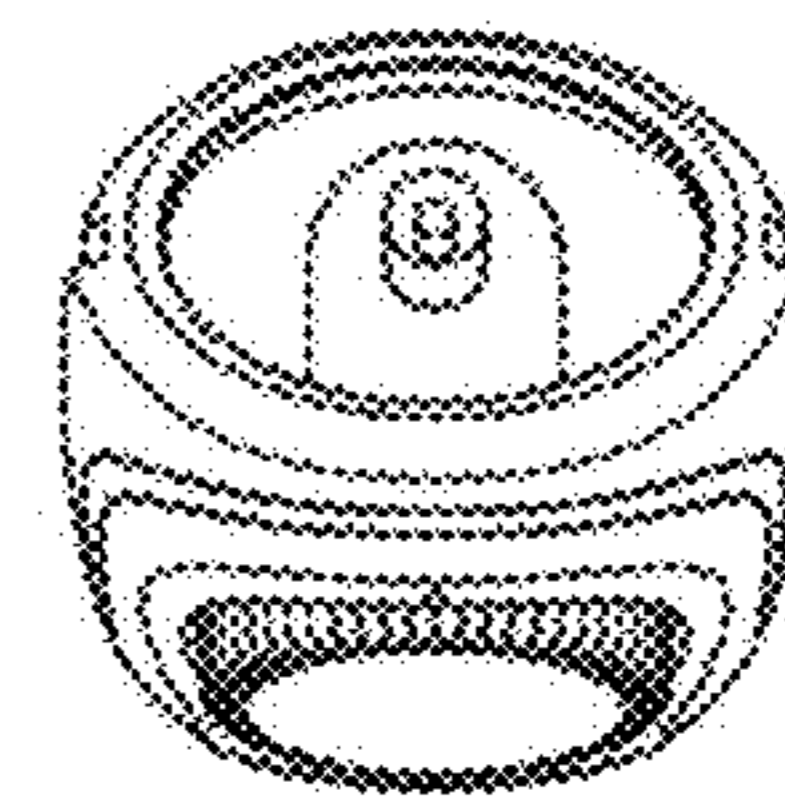

Fig. 6

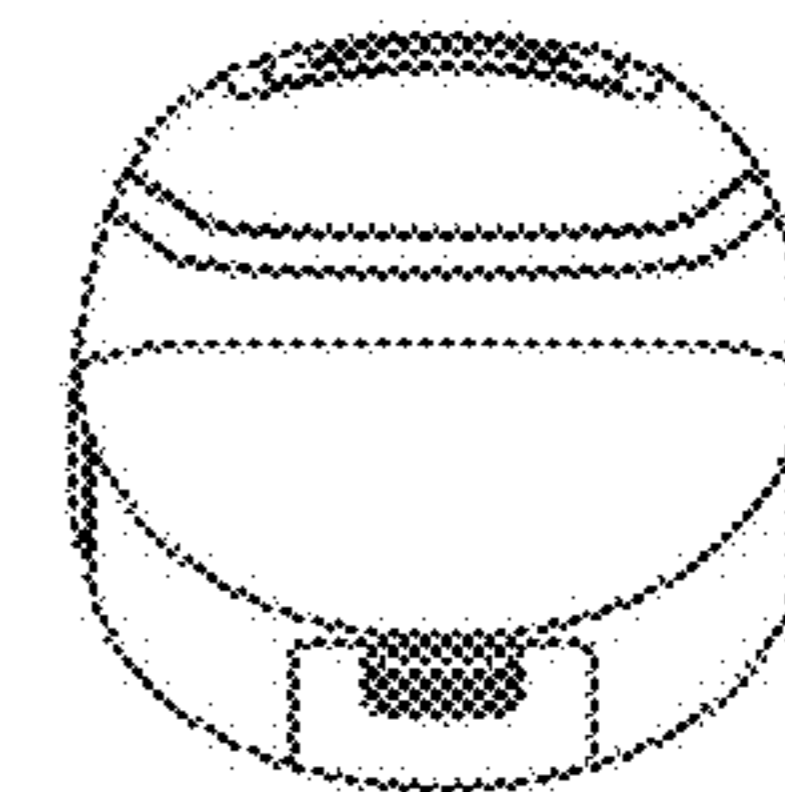

Fig. 7