



US00D942029S

(12) **United States Design Patent** (10) **Patent No.:** **US D942,029 S**  
**Wang** (45) **Date of Patent:** **\*\* Jan. 25, 2022**

(54) **BLACKHEAD REMOVER**

OTHER PUBLICATIONS

(71) Applicant: **Dongguan Dingyimei Electronic Technology Co., Ltd.**, Dongguan (CN)

Blackhead Remover Vacuum Pore Cleanser. Date: Dec. 7, 2018. [online]. [Site visited May 19, 2021], Available from Internet URL: <https://www.amazon.com/dp/B07JWD2RCJ/> (Year: 2018).\*

(72) Inventor: **Shaowu Wang**, Dongguan (CN)

TURATA Blackhead Remover. Date: Oct. 10, 2019. [online]. [Site visited May 20, 2021], Available from Internet URL: <https://www.amazon.co.uk/dp/B07YZDQ1QZ/?th=1> (Year: 2019).\*

(\*\*) Term: **15 Years**

Blackhead removers. (Design—© Questel) orbit.com. [Online PDF compilation of references] 31 pgs. Print Dates Range Apr. 15, 2015-Mar. 31, 2020 [Retrieved May 20, 2021] <https://www.orbit.com/export/UCZAH96B/pdf4/00a91d87-60aa-4152-8f41-c88daf7c7213-232539.pdf> (Year: 2021).\*

(21) Appl. No.: **29/730,735**

(22) Filed: **Apr. 8, 2020**

(51) **LOC (13) Cl.** ..... **28-03**

(52) **U.S. Cl.**  
USPC ..... **D24/214**

(58) **Field of Classification Search**  
USPC ..... D24/215, 200, 211, 212, 213, 214, 133, D24/188, 107, 231; D10/57; D28/58  
CPC .... A61B 2017/00761; A61B 2017/306; A61B 2017/00747; A61B 2217/005; A61B 2018/00452; A61N 5/0616; A61H 35/04; A61H 7/003; A61H 7/004; A61H 7/008; A61H 7/00; A61M 1/00

See application file for complete search history.

\* cited by examiner

*Primary Examiner* — Susan Bennett Hattan  
*Assistant Examiner* — Landon Thomas Cassell  
(74) *Attorney, Agent, or Firm* — Rumi Ranjit Kanakia

(56) **References Cited**

U.S. PATENT DOCUMENTS

|                   |         |         |       |                |
|-------------------|---------|---------|-------|----------------|
| D738,516 S *      | 9/2015  | Karim   | ..... | D24/200        |
| D795,423 S *      | 8/2017  | Chen    | ..... | D24/133        |
| D827,843 S *      | 9/2018  | Bainton | ..... | D24/200        |
| D856,827 S *      | 8/2019  | Liang   | ..... | D10/57         |
| D859,681 S *      | 9/2019  | Tang    | ..... | D24/214        |
| D860,470 S *      | 9/2019  | Li      | ..... | D24/214        |
| D861,181 S *      | 9/2019  | Shen    | ..... | D24/209        |
| D862,717 S *      | 10/2019 | Khubani | ..... | D24/200        |
| D865,990 S *      | 11/2019 | Ko      | ..... | D24/215        |
| D875,267 S *      | 2/2020  | Zeng    | ..... | D24/214        |
| D906,530 S *      | 12/2020 | Liu     | ..... | D24/214        |
| D908,909 S *      | 1/2021  | Huang   | ..... | D24/215        |
| D909,563 S *      | 2/2021  | Hou     | ..... | D24/108        |
| 2020/0015841 A1 * | 1/2020  | Friend  | ..... | A61B 17/320068 |
| 2020/0179220 A1 * | 6/2020  | Jablow  | ..... | A61H 1/00      |
| 2020/0222269 A1 * | 7/2020  | Rodan   | ..... | A45D 26/0004   |

(57) **CLAIM**

I claim the ornamental design for a blackhead remover, as shown and described.

**DESCRIPTION**

FIG. 1 is a Perspective view of a blackhead remover showing my new design;  
FIG. 2 is a front view thereof;  
FIG. 3 is a back view thereof;  
FIG. 4 is a right-side view thereof;  
FIG. 5 is a left-side view thereof;  
FIG. 6 is a Top view thereof;  
FIG. 7 is a Bottom view thereof;  
FIG. 8 is another Perspective view with a different head;  
FIG. 9 is yet another Perspective view with another head;  
and,  
FIG. 10 is yet another Perspective view with another head. The broken lines depict portions of the blackhead remover that form no part of the claimed design.

**1 Claim, 10 Drawing Sheets**

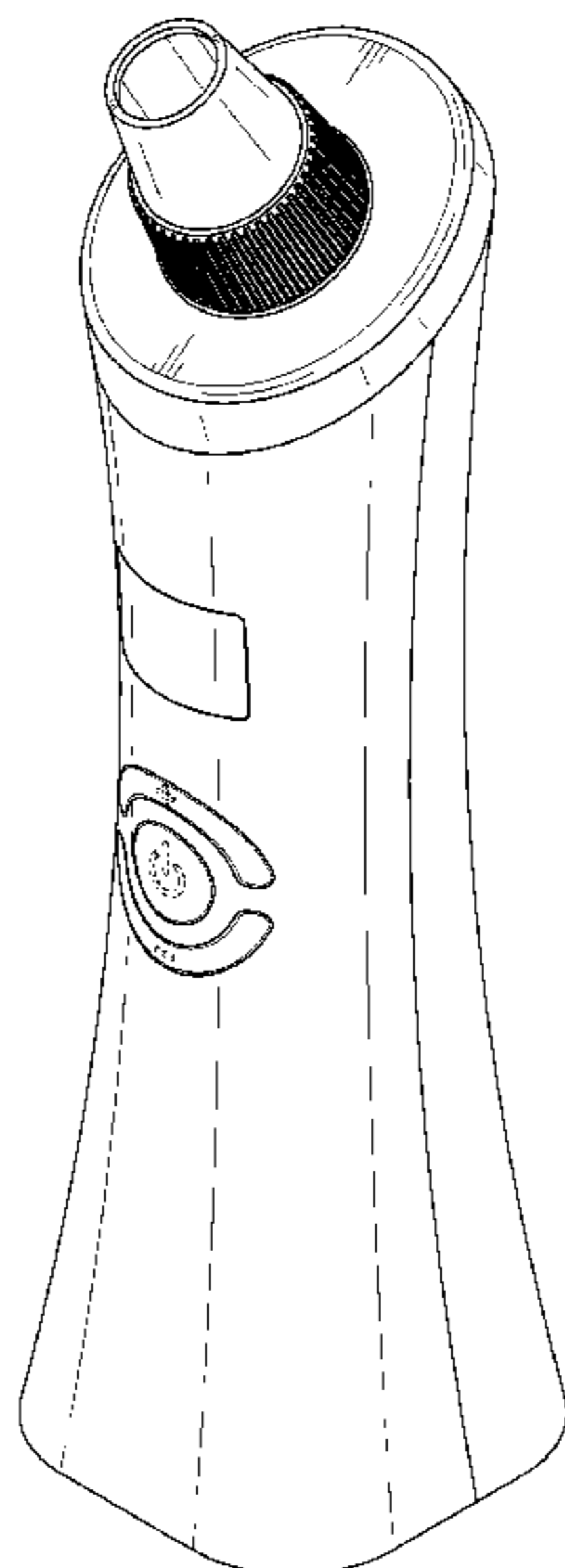

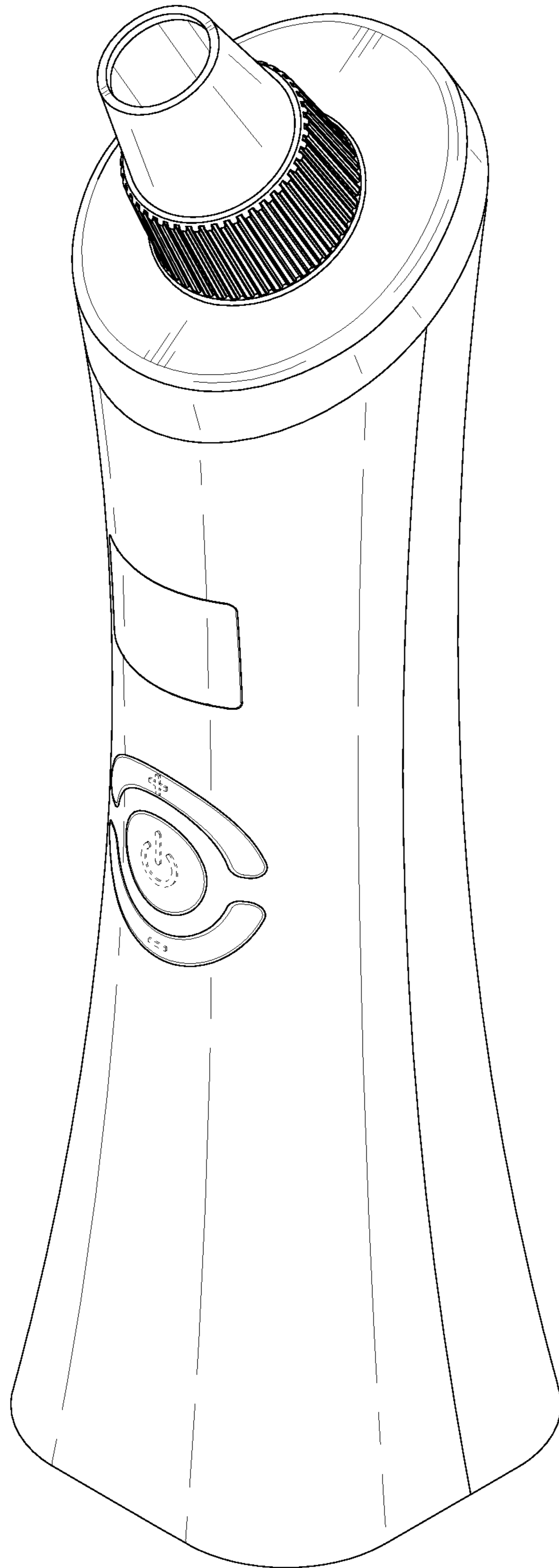

FIG. 1

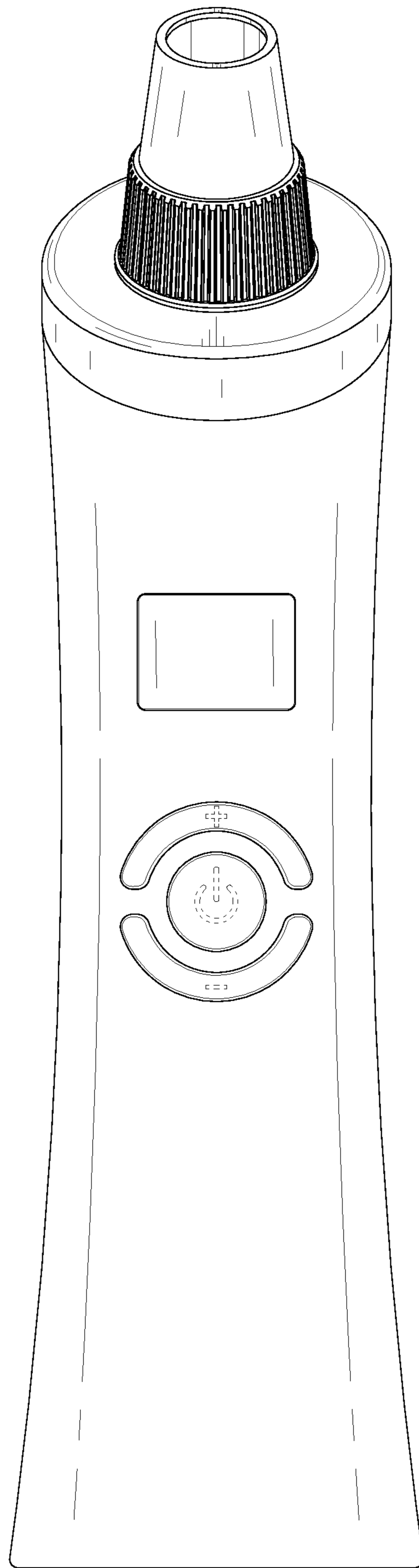

FIG. 2

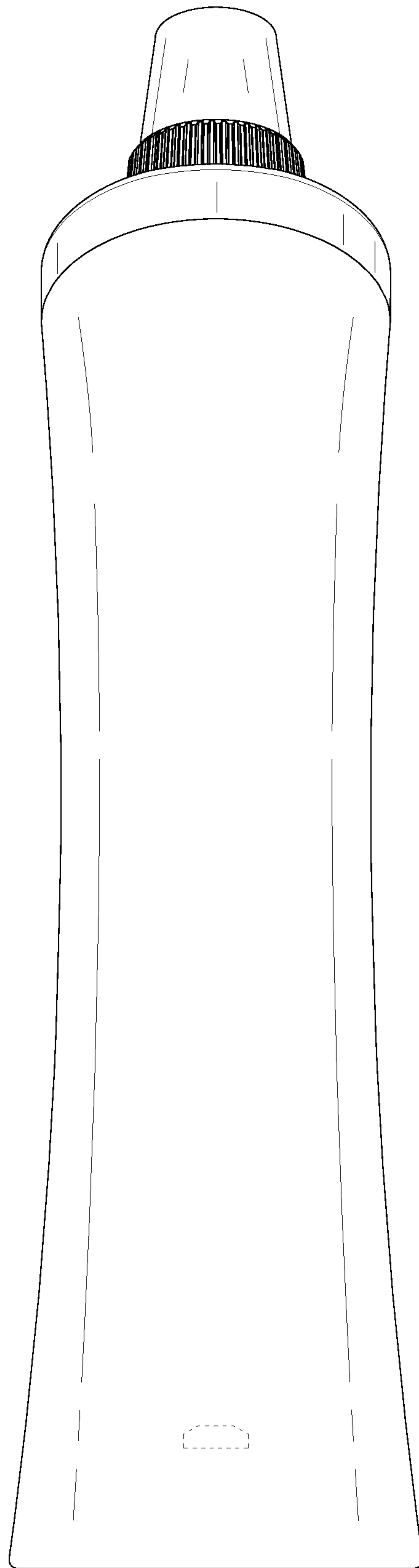

FIG. 3

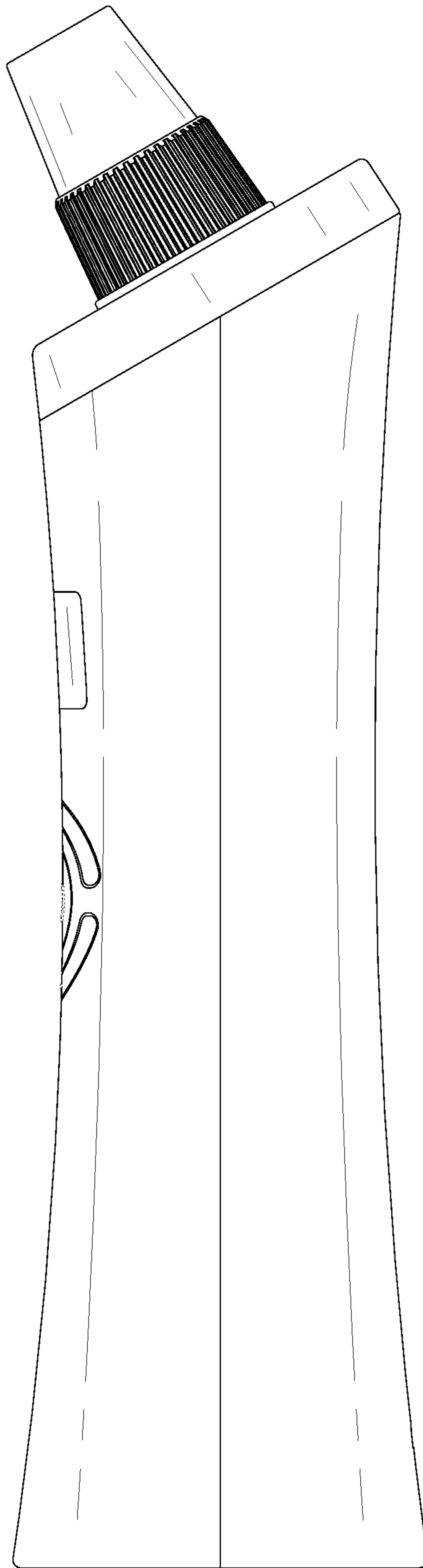

FIG. 4

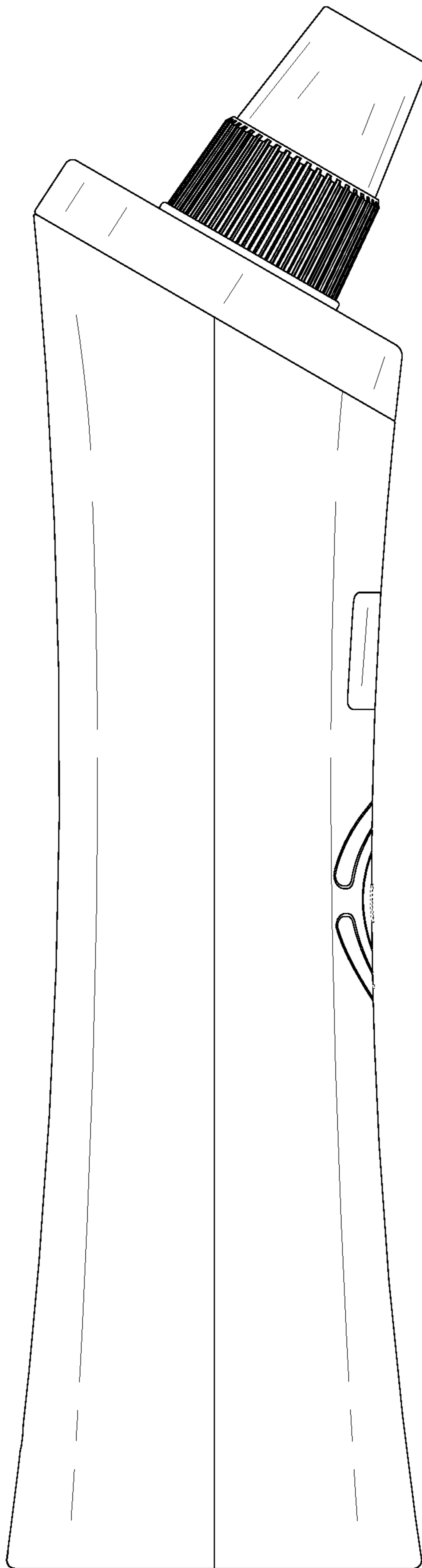

FIG. 5

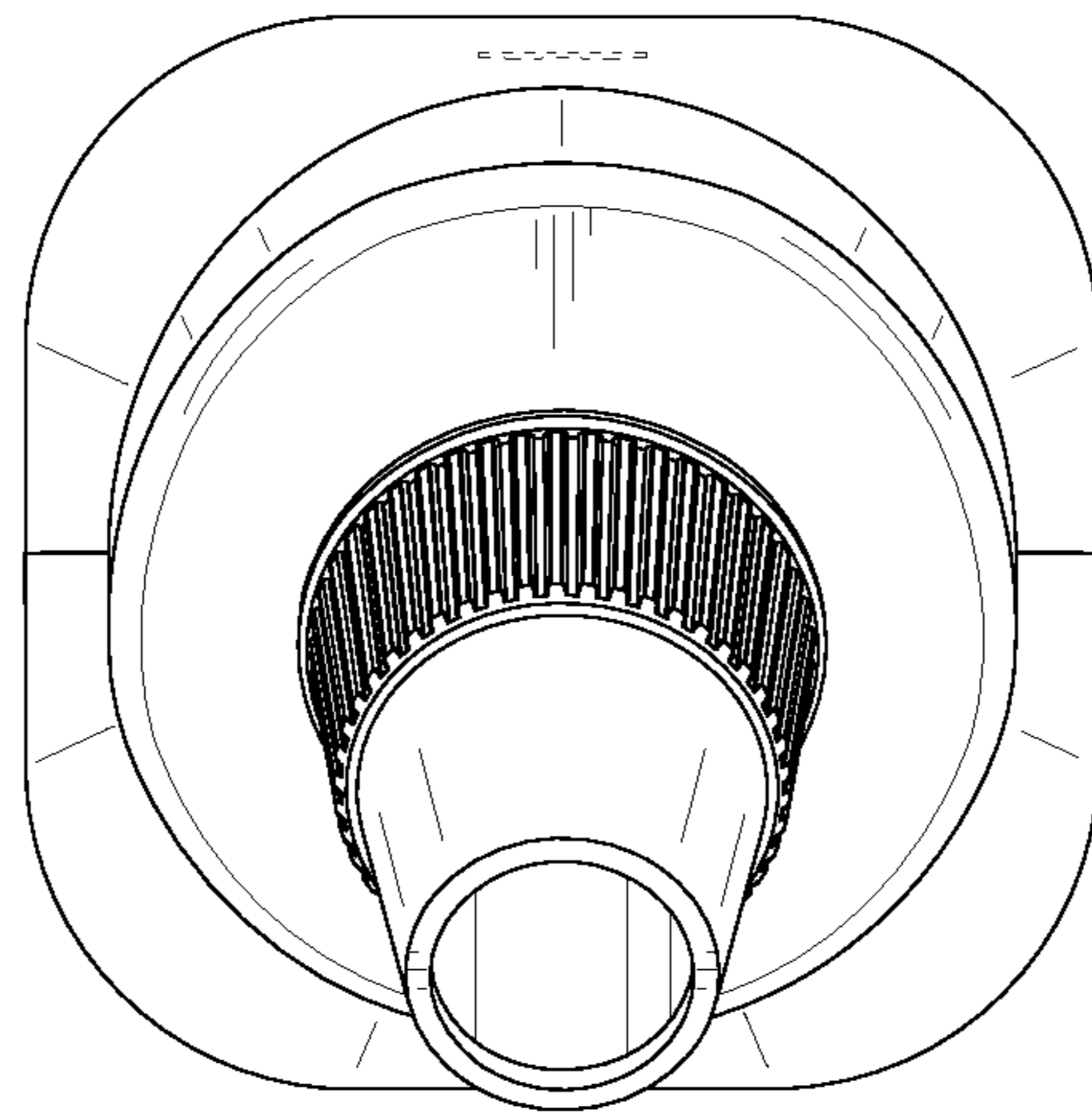

FIG. 6

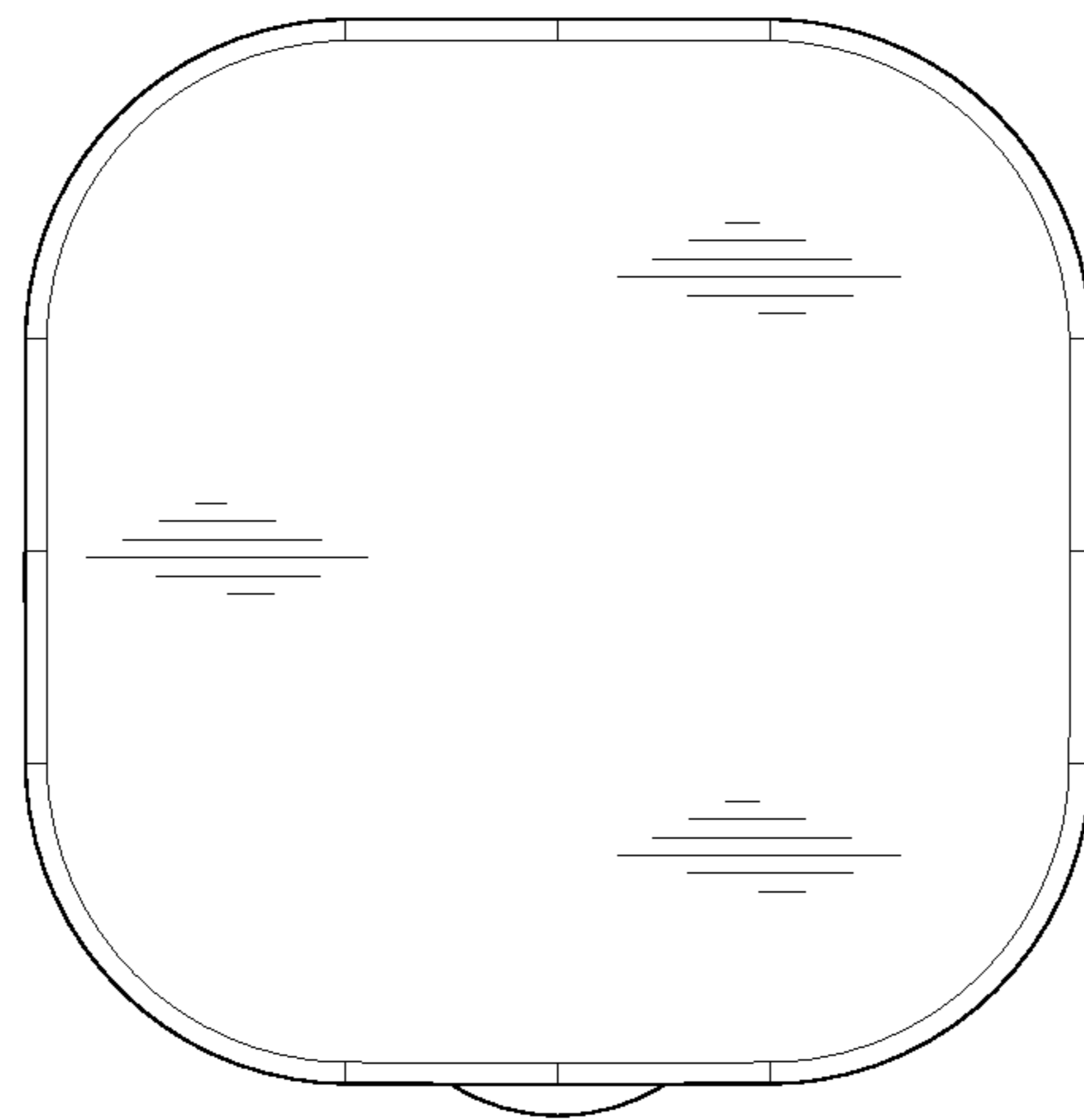

FIG. 7



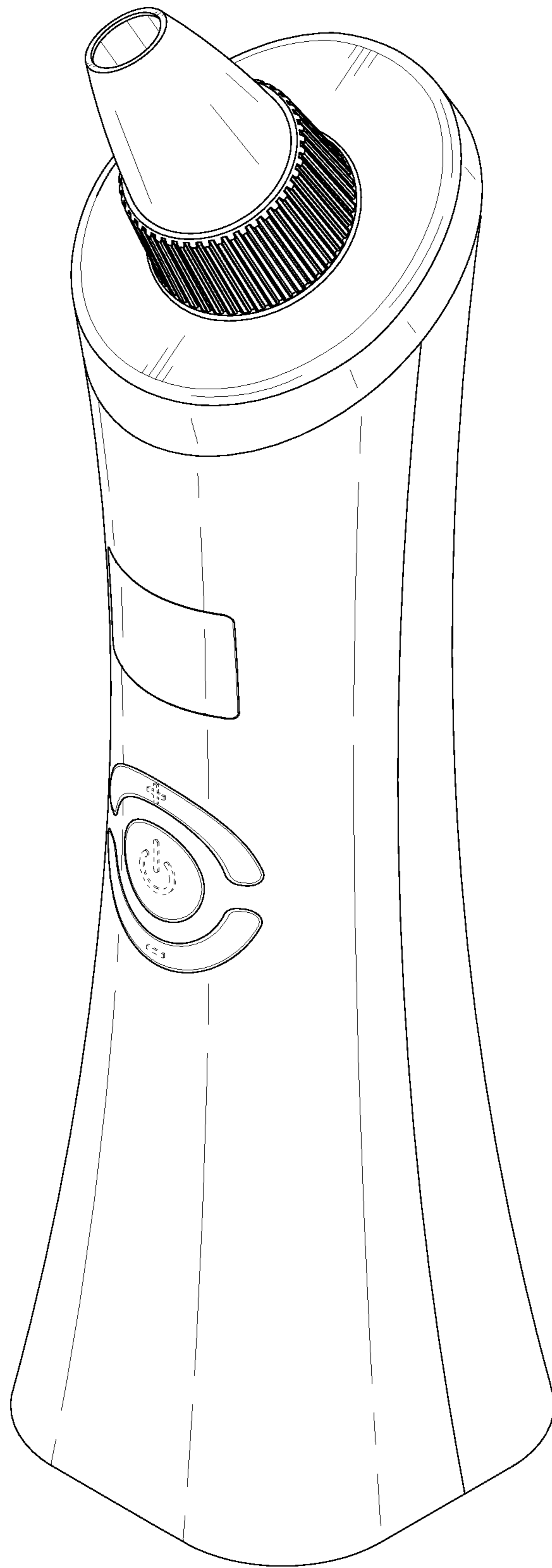

FIG. 8

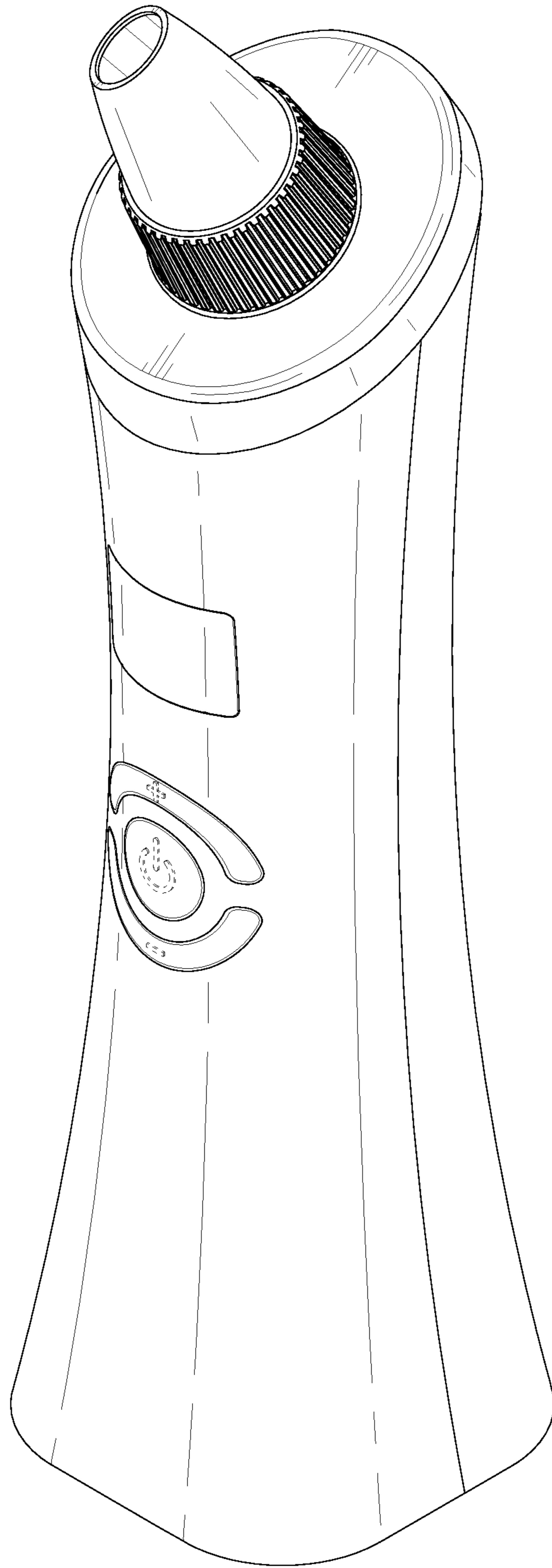

FIG. 9

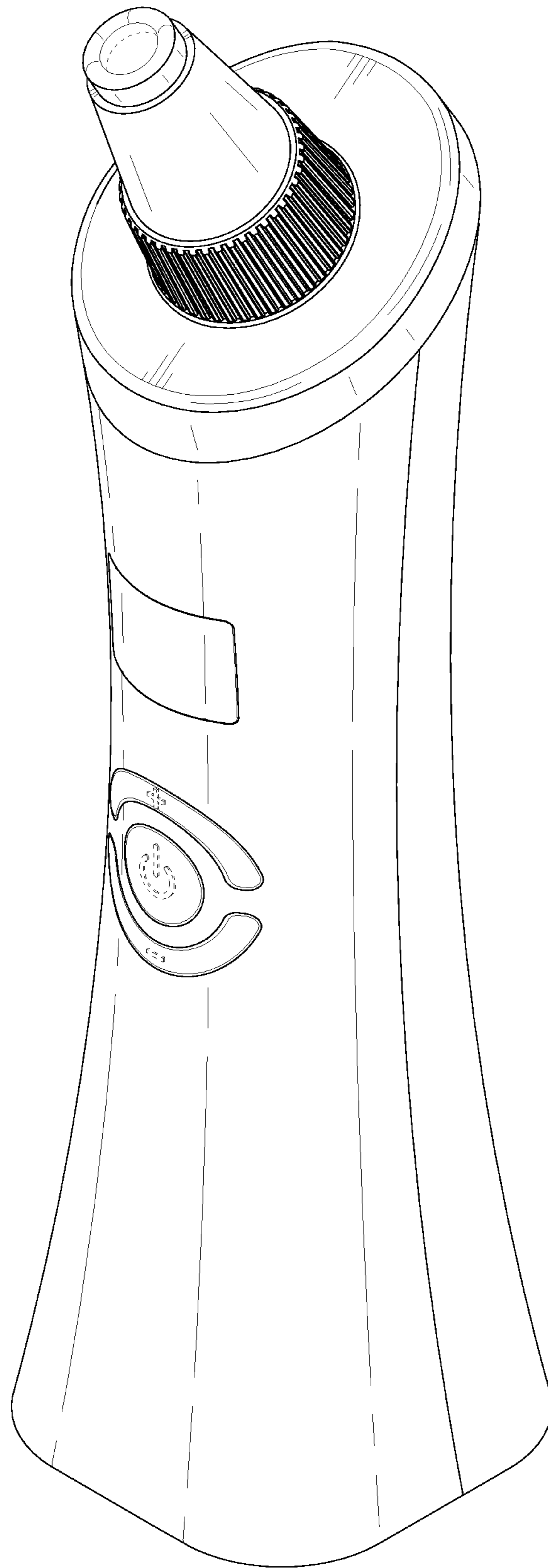

FIG. 10