



US00D942000S

(12) **United States Design Patent**  
**Huxel et al.**

(10) **Patent No.:** **US D942,000 S**  
(45) **Date of Patent:** **\*\* Jan. 25, 2022**

(54) **SWAB**

- (71) Applicant: **IMFLUX INC.**, Hamilton, OH (US)
- (72) Inventors: **Brent Huxel**, Cincinnati, OH (US);  
**Daniel David Lumpkin**, Cincinnati, OH (US);  
**Jeff Klare**, Liberty Township, OH (US);  
**Mark Reagan**, Bellbrook, OH (US);  
**Mary Wagner**, Cincinnati, OH (US)
- (73) Assignee: **IMFLUX INC.**, Hamilton, OH (US)
- (\*\*) Term: **15 Years**
- (21) Appl. No.: **29/737,922**
- (22) Filed: **Jun. 12, 2020**
- (51) **LOC (13) Cl.** ..... **24-02**
- (52) **U.S. Cl.**  
USPC ..... **D24/119**
- (58) **Field of Classification Search**  
USPC ..... D24/100, 105, 107–108, 110–119, 10.5,  
D24/127–130, 144–149, 132–135,  
D24/137–138, 140–141, 152, 172–174,  
D24/176, 185–186, 208, 211, 214–215,  
D24/220, 222; D8/98–100, 105, 14, 17,  
D8/20, 305, 315–316, 47; D32/45, 51;  
600/562, 564, 566–567; 604/1; 606/162  
CPC ..... A61B 17/1615; A61B 17/1697; A61B  
2018/0231; A61F 13/15; A61F 13/64;  
A61F 13/476; A61F 13/5611; A61F  
13/4704; A61F 13/38; A61F 13/5616;  
A61F 13/4758; A61F 13/472; A61C  
19/04; B01L 2300/0825; B01L 3/5023;  
B01L 3/5029; C12M 1/30; G01N 33/5302  
See application file for complete search history.

(56) **References Cited**

**U.S. PATENT DOCUMENTS**

- 2,876,501 A \* 3/1959 Glickston ..... A61F 13/38  
19/149
- 3,818,911 A 6/1974 Fournier  
(Continued)

**OTHER PUBLICATIONS**

P&G Partners With Rhinostics to Take Innovative Nasal Swab to Market to Improve Speed of COVID-19 Testing, first available Jan. 22, 2021, businesswire.com, [online], [site visited Oct. 29, 2021], Available from internet URL: <https://www.businesswire.com/news/home/20210122005202/en/PG-Partners-With-Rhinostics-to-Take-Innovative-Nasal-Swab-to-Market-to-Improve-Speed-of-COVID-19-Testing> (Year: 2021).\*

(Continued)

*Primary Examiner* — Samantha Q Lawrence

*Assistant Examiner* — Holly M Rodriguez

(74) *Attorney, Agent, or Firm* — Marshall, Gerstein & Borun LLP

(57) **CLAIM**

The ornamental design for a swab, as shown and described.

**DESCRIPTION**

FIG. 1 is a perspective view of a swab of the new design; FIG. 2 is a front view of the invention illustrated in FIG. 1; FIG. 3 is a rear view of the invention illustrated in FIG. 1; FIG. 4 is a right side view of the invention illustrated in FIG. 1; FIG. 5 is a left side view of the invention illustrated in FIG. 1; FIG. 6 is a top view of the invention illustrated in FIG. 1; and, FIG. 7 is a bottom view of the invention illustrated in FIG. 1.

The swab is shown with a symbolic break in its length. The appearance of any portion of the article between the break lines forms no part of the claimed invention.

**1 Claim, 3 Drawing Sheets**

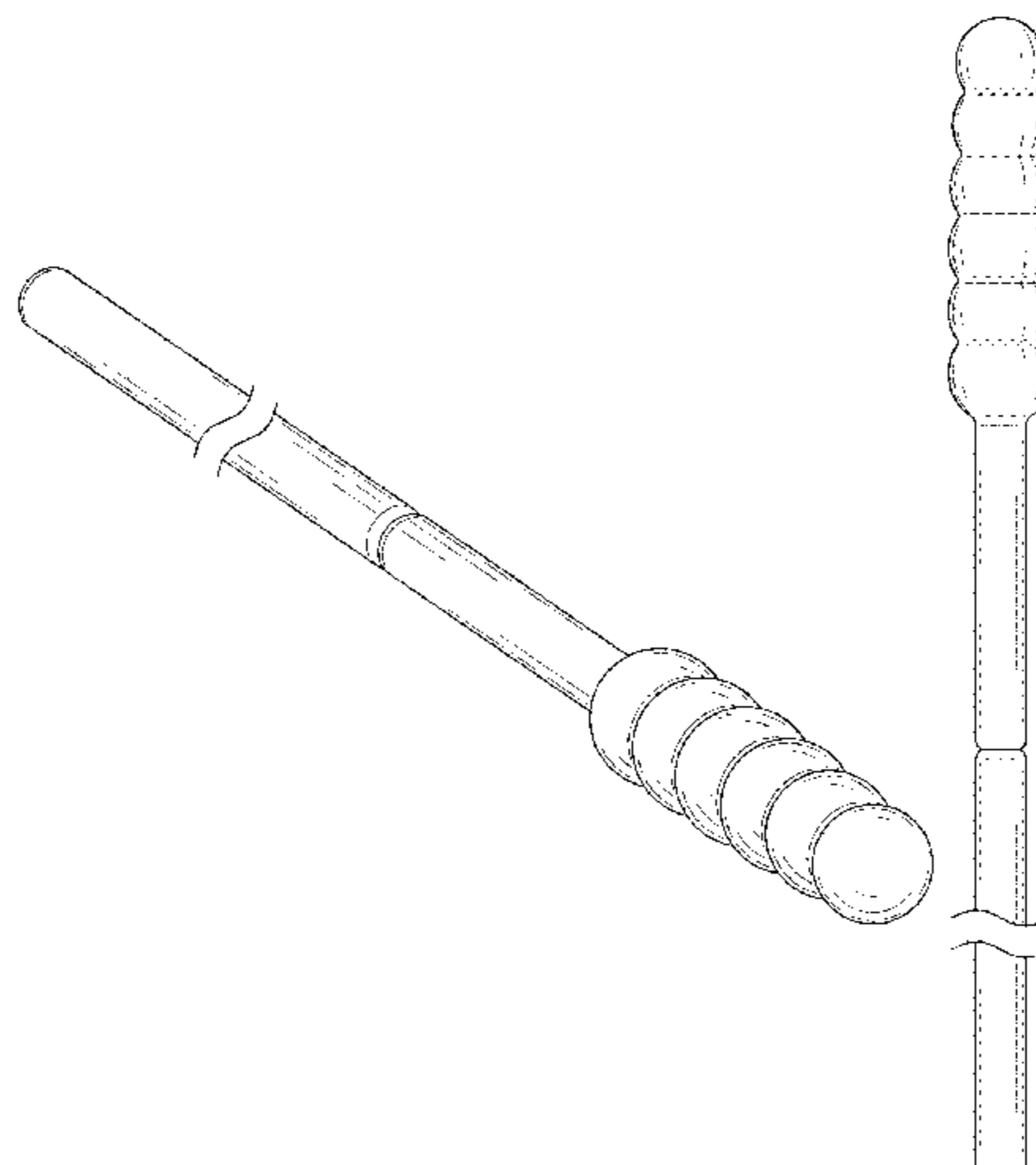

(56)

**References Cited**

## U.S. PATENT DOCUMENTS

4,746,238 A \* 5/1988 Levine ..... A61F 13/38  
401/196  
4,820,259 A \* 4/1989 Stevens ..... A61F 11/00  
604/1  
5,715,559 A \* 2/1998 Mitri ..... A61F 13/38  
15/118  
D779,654 S \* 2/2017 Pourbaba ..... D24/119  
2016/0310328 A1 \* 10/2016 Pourbaba ..... A61F 13/38

## OTHER PUBLICATIONS

Double Tipped Cotton Buds with Paper Stick, first available Apr. 29, 2020, amazon.com, [online], [site visited Oct. 29, 2021], Available from internet URL: [https://www.amazon.com/dp/B0823G1KDX/ref=sspa\\_dk\\_detail\\_4?psc=1&pf\\_rd\\_p=54ed5474-54a8-4c7f-a88a-45f748d18166&pd\\_rd\\_wg=wXyJC&pf\\_r%E2%80%A6](https://www.amazon.com/dp/B0823G1KDX/ref=sspa_dk_detail_4?psc=1&pf_rd_p=54ed5474-54a8-4c7f-a88a-45f748d18166&pd_rd_wg=wXyJC&pf_r%E2%80%A6) (Year: 2020).\*

Strogem Reusable Cotton Swabs with 1 Mirror for Makeup, first available Nov. 6, 2020, amazon.com, [online], [site visited Oct. 29, 2021], Available from internet URL: [https://www.amazon.com/dp/B08GGCKG3W/ref=sspa\\_dk\\_detail\\_1?psc=1&pf\\_rd\\_p=9fd3ea7c-b77c-42ac-b43b-c872d3f37c38&pd\\_rd\\_wg=2hhAM&pf\\_%E2%80%A6](https://www.amazon.com/dp/B08GGCKG3W/ref=sspa_dk_detail_1?psc=1&pf_rd_p=9fd3ea7c-b77c-42ac-b43b-c872d3f37c38&pd_rd_wg=2hhAM&pf_%E2%80%A6) (Year: 2020).\*

Tifanso 200 Count Black Cotton Swabs, first available Jul. 5, 2021, amazon.com, [online], [site visited Oct. 29, 2021], Available from internet URL: [https://www.amazon.com/Tifanso-Cruelty-Free-Biodegradable-Chlorine-Free-Hypoallergenic/dp/B07R8B93GL/ref=pd\\_vtp\\_7/137-8820035-3287302?p%E2%80%A6](https://www.amazon.com/Tifanso-Cruelty-Free-Biodegradable-Chlorine-Free-Hypoallergenic/dp/B07R8B93GL/ref=pd_vtp_7/137-8820035-3287302?p%E2%80%A6) (Year: 2021).\*

\* cited by examiner

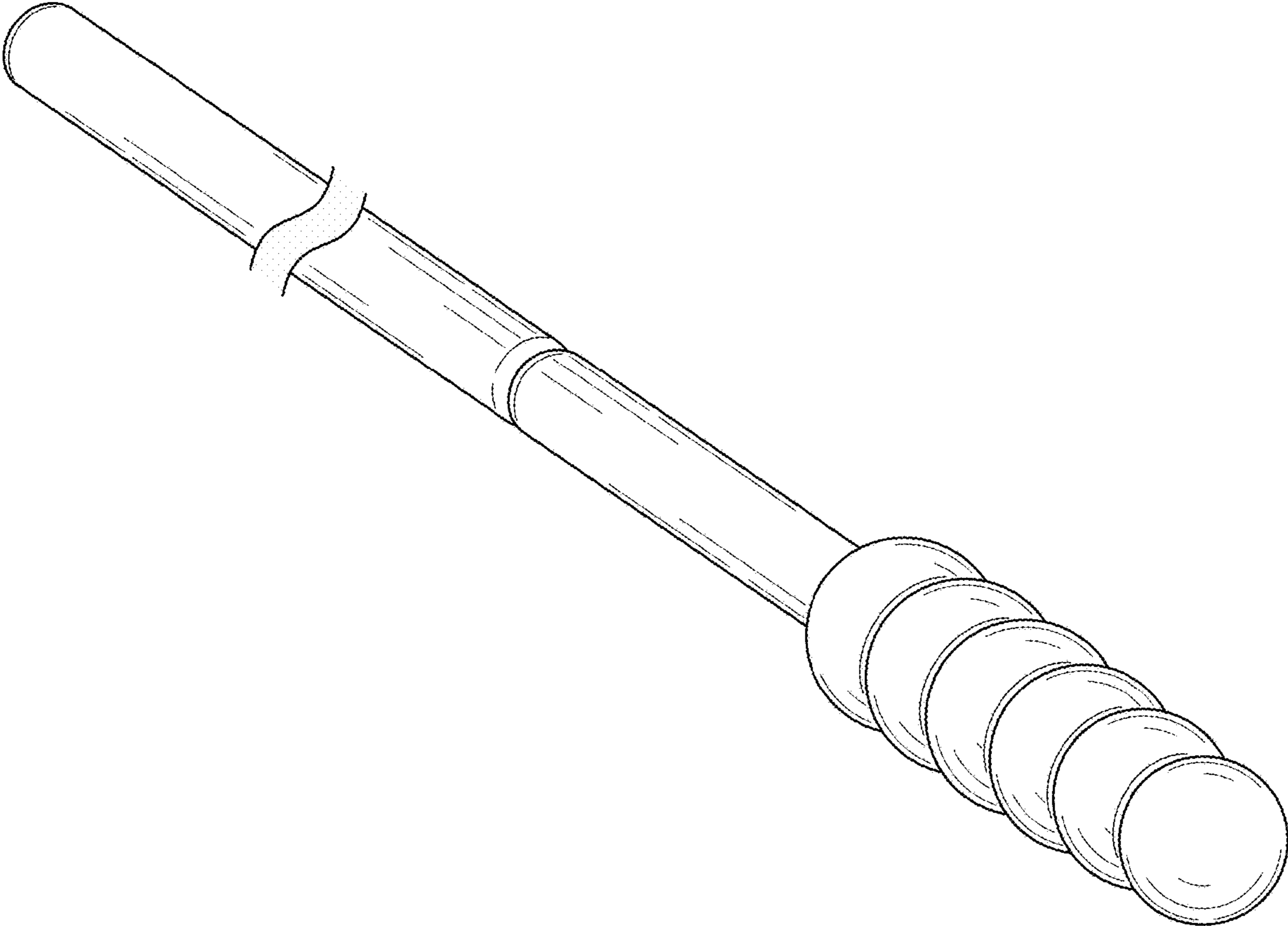

FIG. 1

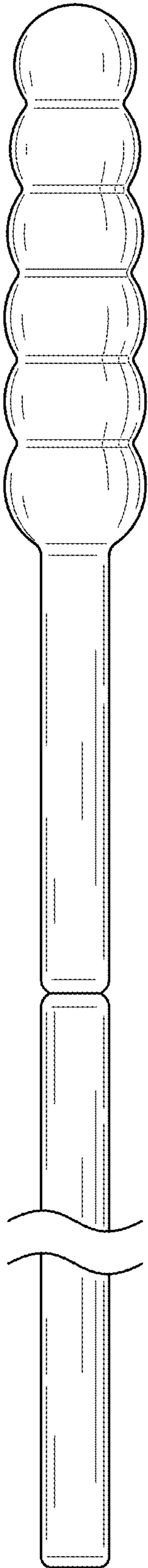

FIG. 2

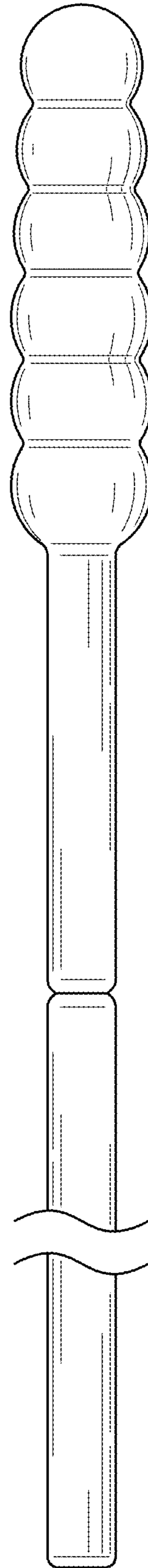

FIG. 3

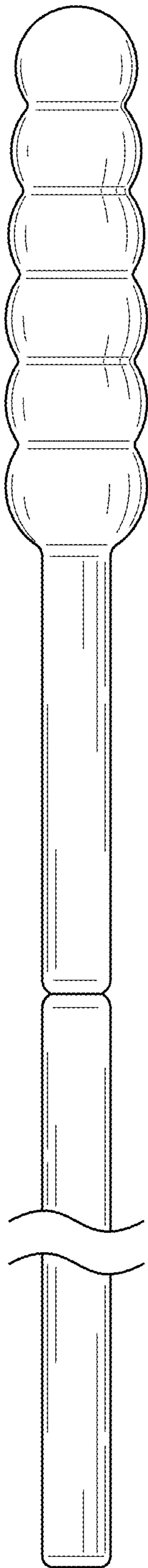

FIG. 4

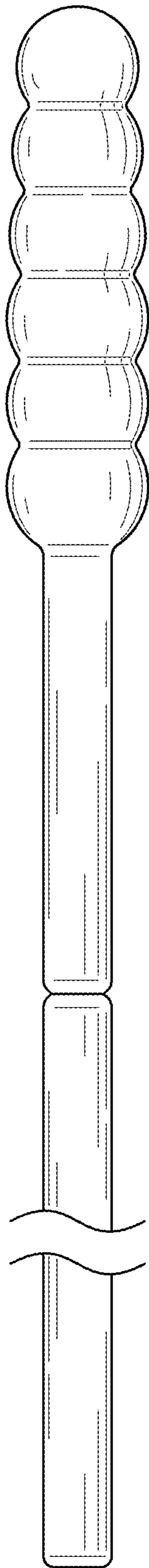

FIG. 5

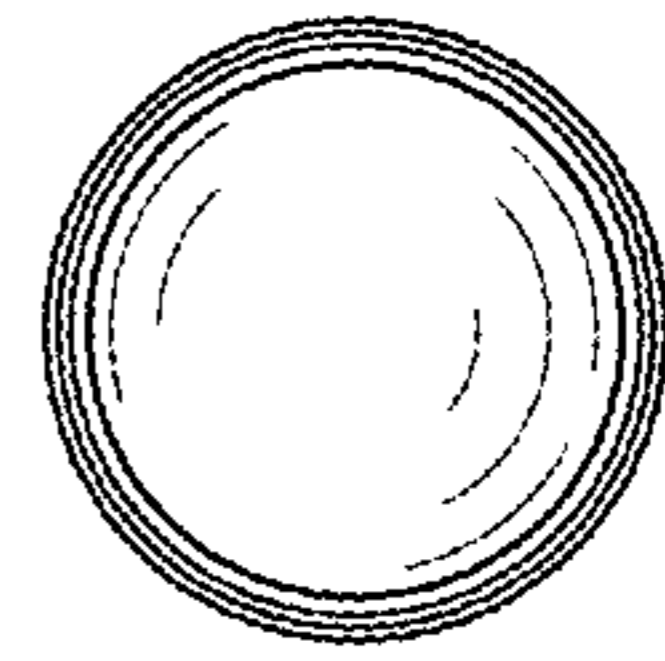

FIG. 6

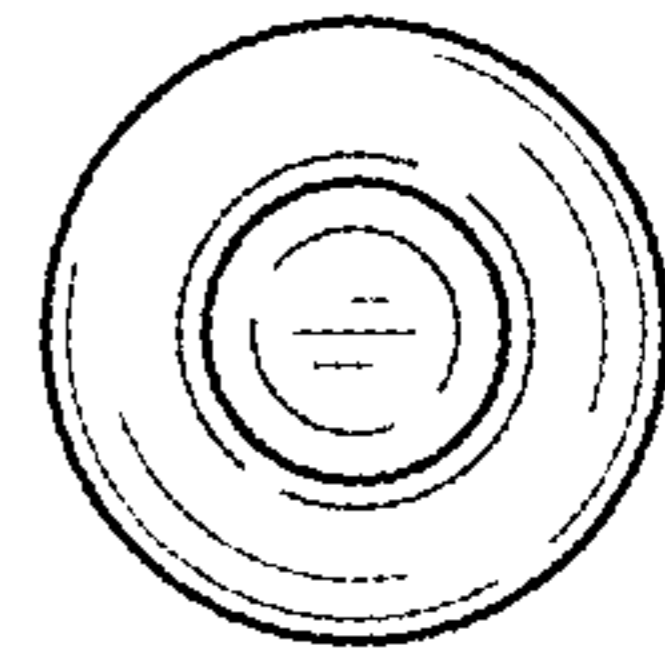

FIG. 7