



US00D941956S

(12) **United States Design Patent**  
**Urry**

(10) **Patent No.:** **US D941,956 S**  
(45) **Date of Patent:** **\*\* Jan. 25, 2022**

- (54) **WATERING NOZZLE**
- (71) Applicant: **Orbit Irrigation Products, LLC**, North Salt Lake, UT (US)
- (72) Inventor: **Andrew Mark Urry**, Riverton, UT (US)
- (73) Assignee: **Orbit Irrigation Products, LLC**, North Salt Lake, UT (US)
- (\*\*) Term: **15 Years**
- (21) Appl. No.: **29/696,894**
- (22) Filed: **Jul. 2, 2019**
- (51) **LOC (13) Cl.** ..... **23-01**
- (52) **U.S. Cl.**  
USPC ..... **D23/213**
- (58) **Field of Classification Search**  
USPC ..... D23/213, 214, 215, 222, 223, 224, 226, 223/229, 230  
CPC ..... A61H 9/0021; A61H 33/00; B05B 1/00; B05B 1/14; B05B 1/185; B05B 1/08; B05B 1/02; B05B 1/26; B05B 12/002; B05B 1/18; B05B 9/01  
See application file for complete search history.

(56) **References Cited**

**U.S. PATENT DOCUMENTS**

D422,339 S	4/2000	Ericksen	
D557,377 S	* 12/2007	Chen	D23/223
D653,306 S	* 1/2012	Chen	D23/226
D705,393 S	* 5/2014	Bailey	D23/213
D708,300 S	* 7/2014	Kah, Jr.	D23/214

(Continued)

**OTHER PUBLICATIONS**

Solterra 56700 Adjustable Garden Hose High-Flow Nozzle with Thumb Control, Jan. 16, 2020, Amazon.com, Sep. 18, 2021, URL:

[https://www.amazon.com/Solterra-56700-Adjustable-Garden-Control/dp/B07RH1VJ4B/ref=psdc\\_553972\\_t1\\_B085CMVXGQ?th=1](https://www.amazon.com/Solterra-56700-Adjustable-Garden-Control/dp/B07RH1VJ4B/ref=psdc_553972_t1_B085CMVXGQ?th=1) (Year: 2020).\*

(Continued)

*Primary Examiner* — Jack Reickel  
*Assistant Examiner* — Keith J Wilson  
(74) *Attorney, Agent, or Firm* — Austin Rapp

(57) **CLAIM**

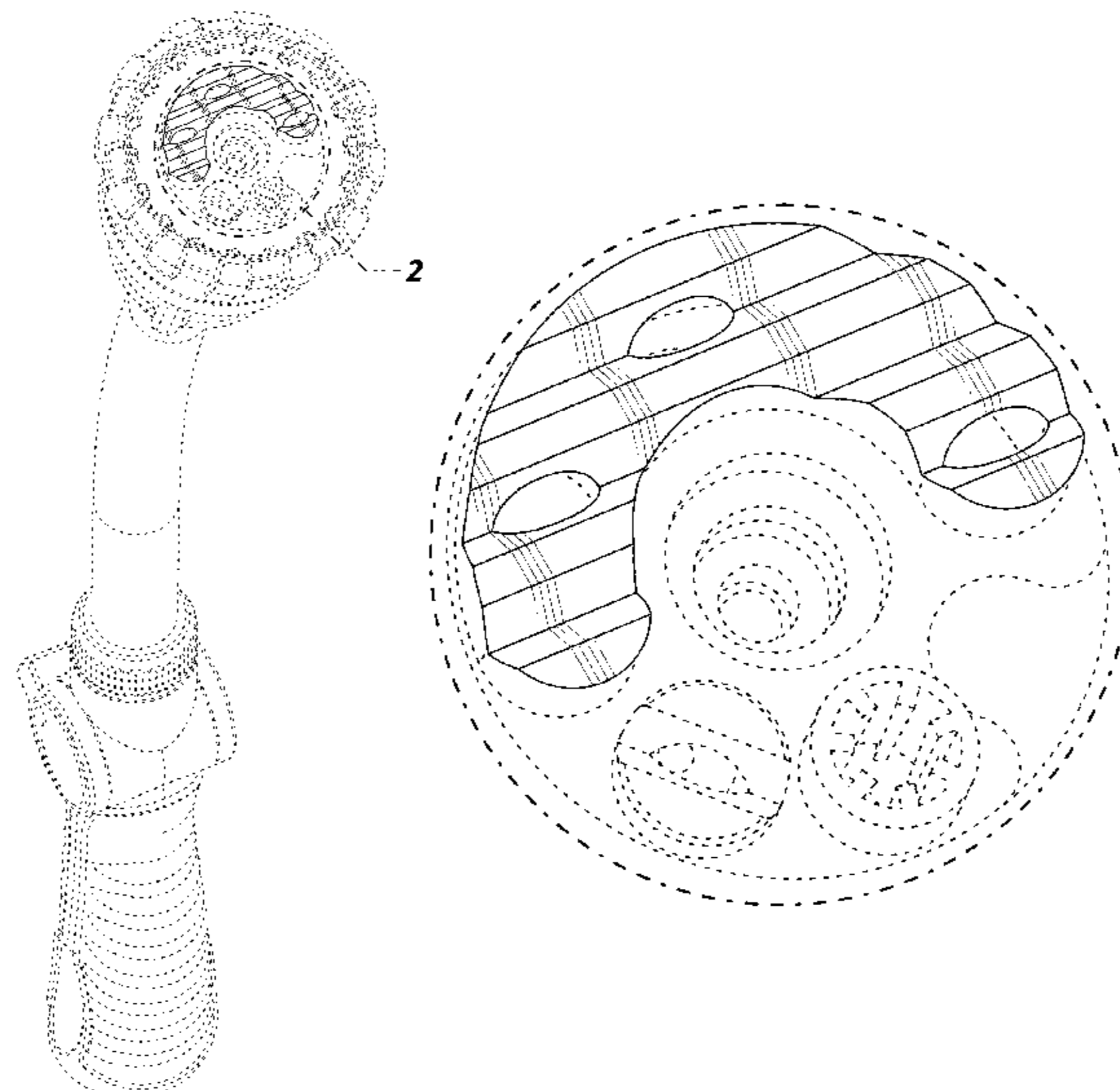
The ornamental design for a watering nozzle, as shown and described.

**DESCRIPTION**

FIG. 1 is a first bottom perspective view of a watering nozzle, according to my new design;  
 FIG. 2 is a bottom perspective, enlarged view of region 2 of FIG. 1;  
 FIG. 3 is a second bottom perspective view of the watering nozzle;  
 FIG. 4 is a bottom perspective, enlarged view of region 4 of FIG. 3;  
 FIG. 5 is a first top perspective view of the watering nozzle;  
 FIG. 6 is a top perspective, enlarged view of region 6 of FIG. 5;  
 FIG. 7 is a second top perspective view of the watering nozzle;  
 FIG. 8 is a top perspective, enlarged view of region 8 of FIG. 7;  
 FIG. 9 is a right perspective view of the watering nozzle;  
 FIG. 10 is a right perspective, enlarged view of region 10 of FIG. 9;  
 FIG. 11 is a left perspective view of the watering nozzle;  
 FIG. 12 is a left perspective, enlarged view of region 12 of FIG. 11;  
 FIG. 13 is a front side view of the watering nozzle; and,  
 FIG. 14 is a front side, enlarged view of region 14 of FIG. 13.

The broken lines in the figures are included for the purpose of illustrating unclaimed portions of the watering nozzle and form no part of the claimed design.

**1 Claim, 14 Drawing Sheets**



(56)

**References Cited**

U.S. PATENT DOCUMENTS

D726,872 S     4/2015 Thurgood  
D809,094 S \*   1/2018 Naslund ..... D23/213  
D863,501 S \*   10/2019 Briscoe ..... D23/213

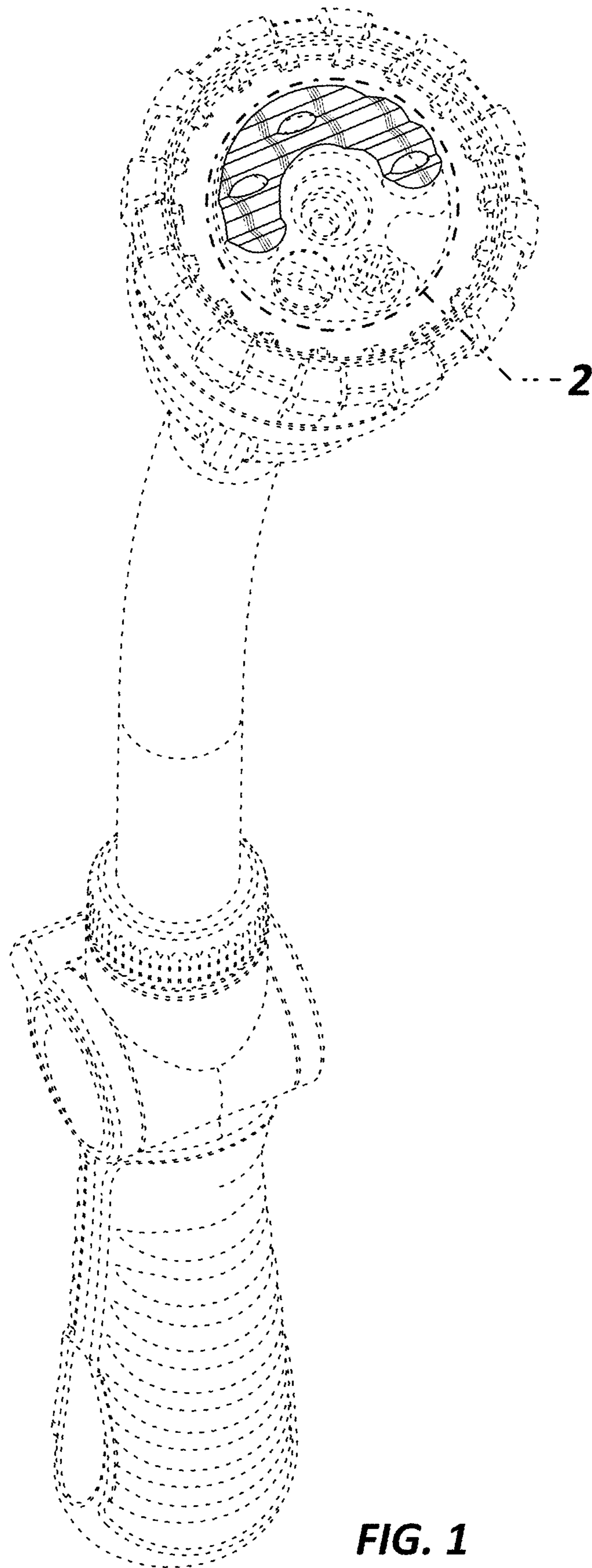
OTHER PUBLICATIONS

A-M Aluminum Gutter Guard 5" (50 Feet, Mill Finish), Dec. 12, 2017, Amazon.com, Sep. 20, 2021, URL: <https://www.amazon.com/M-Aluminum-Gutter-Guard-Finish/dp/B07L486D9K> (Year: 2017).\*

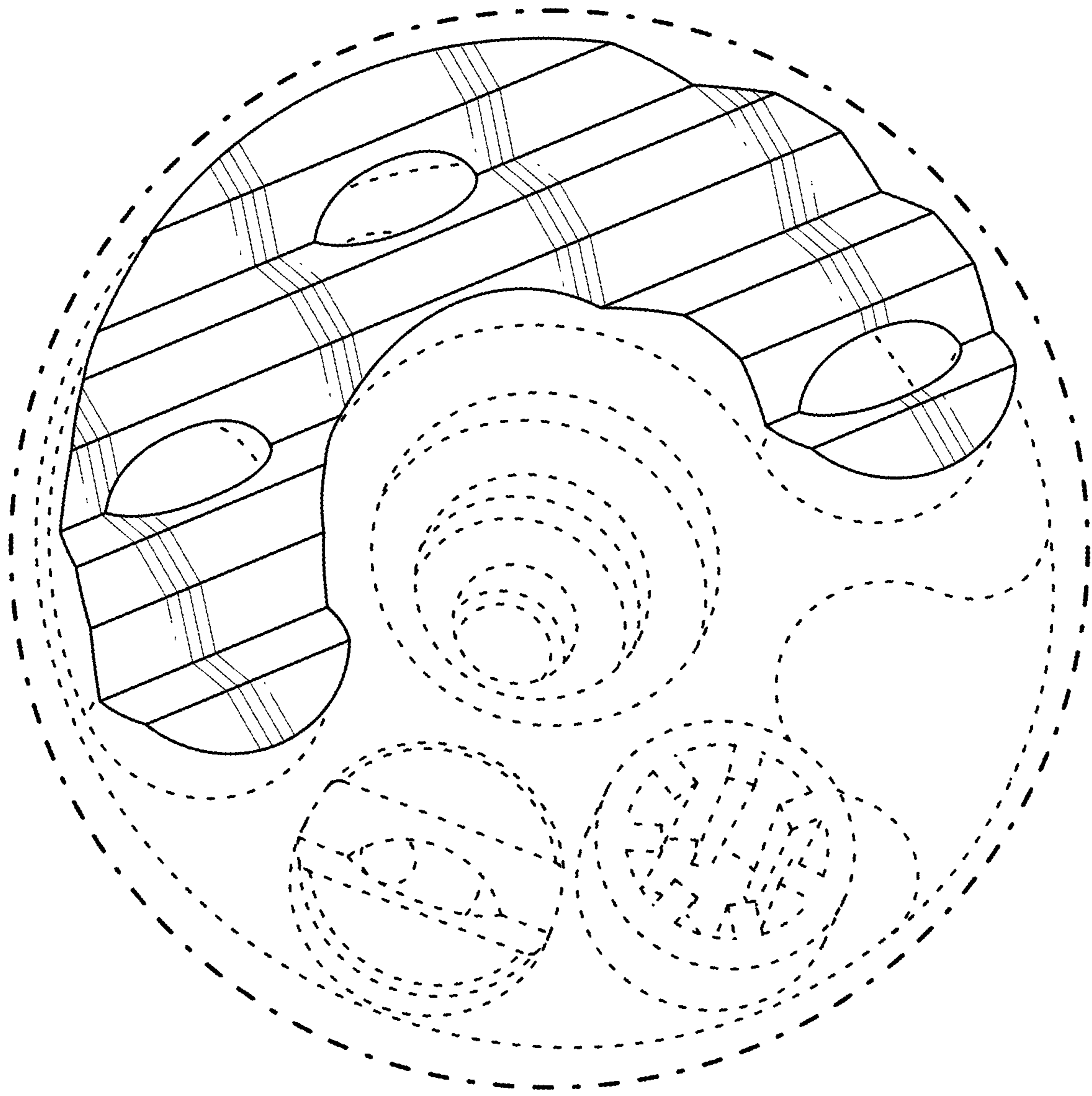
LeafTek 5"×32' Gutter Guard Leaf Protection in Black, Jul. 4, 2018, Amazon.com, Sep. 20, 2021, URL: <https://www.amazon.com/dp/B07JWFK9Z2> (Year: 2018).\*

FlexxPoint 30 Year Gutter Cover System, Jun. 26, 2013, Amazon.com, Sep. 20, 2021, URL: <https://www.amazon.com/dp/B00DMOJK7A> (Year: 2013).\*

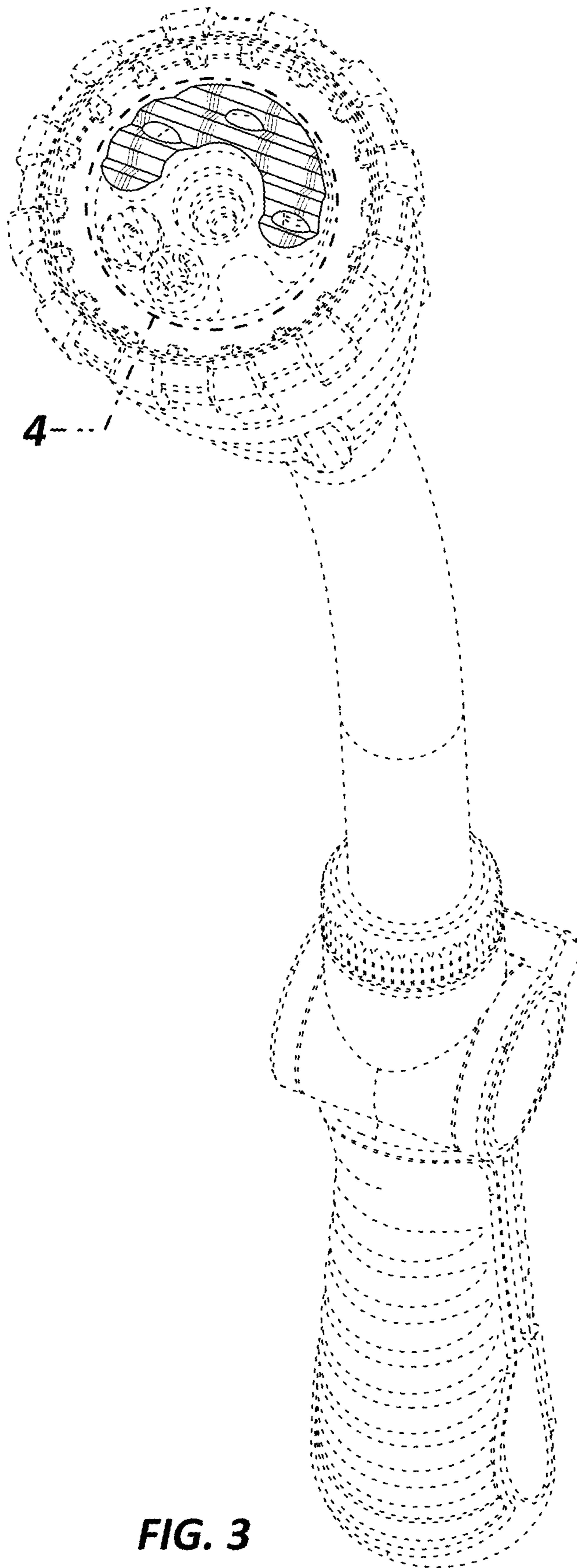
\* cited by examiner



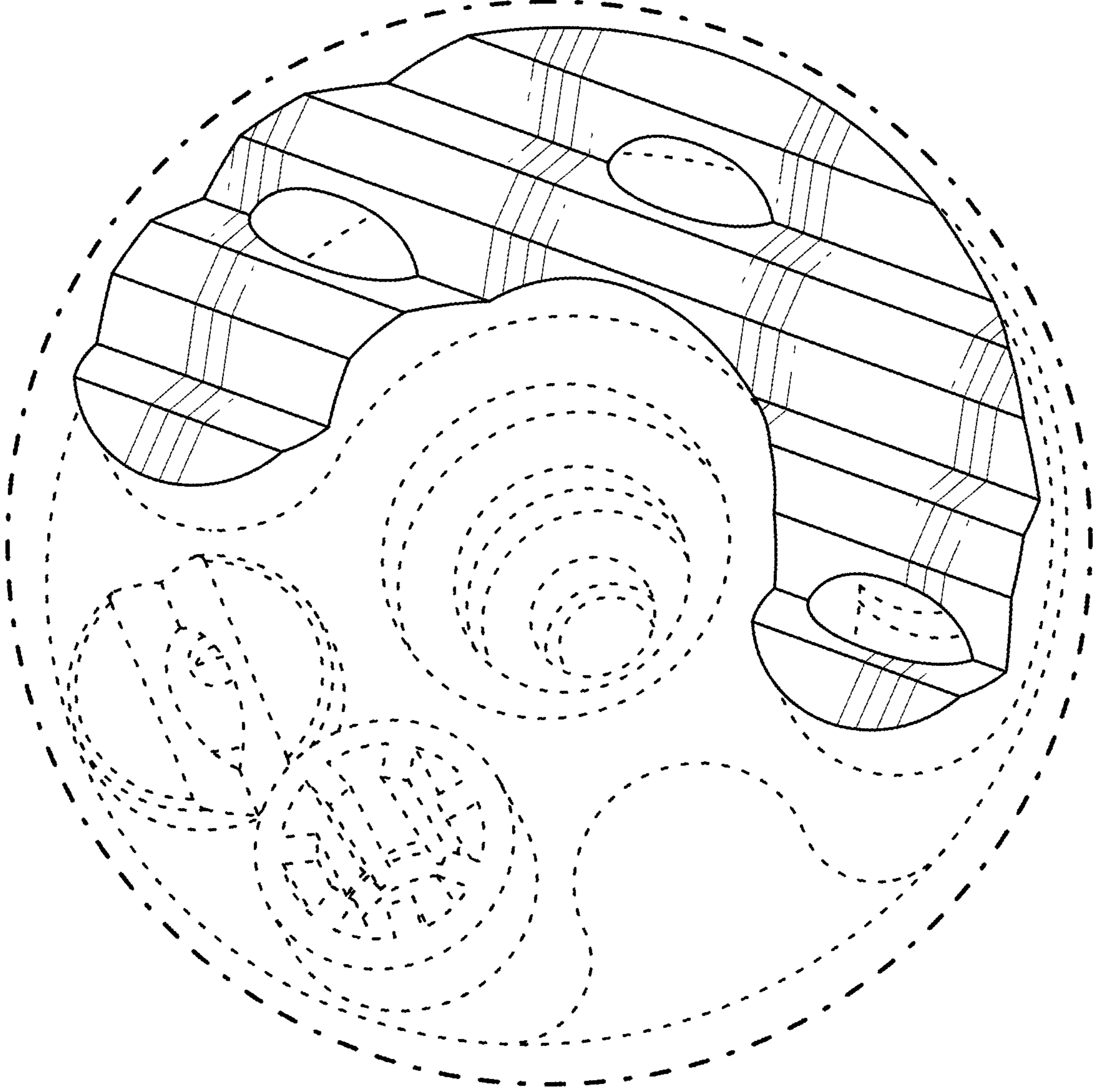
**FIG. 1**



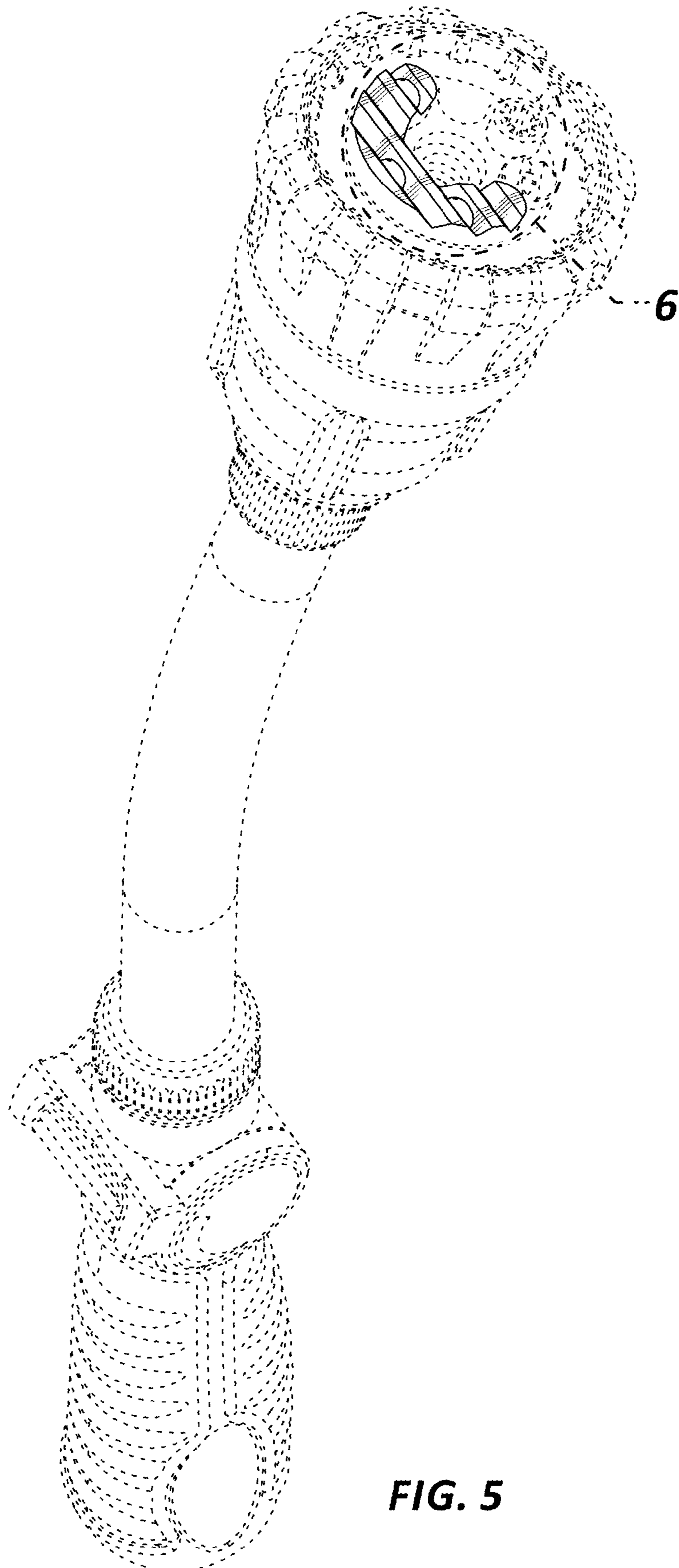
**FIG. 2**

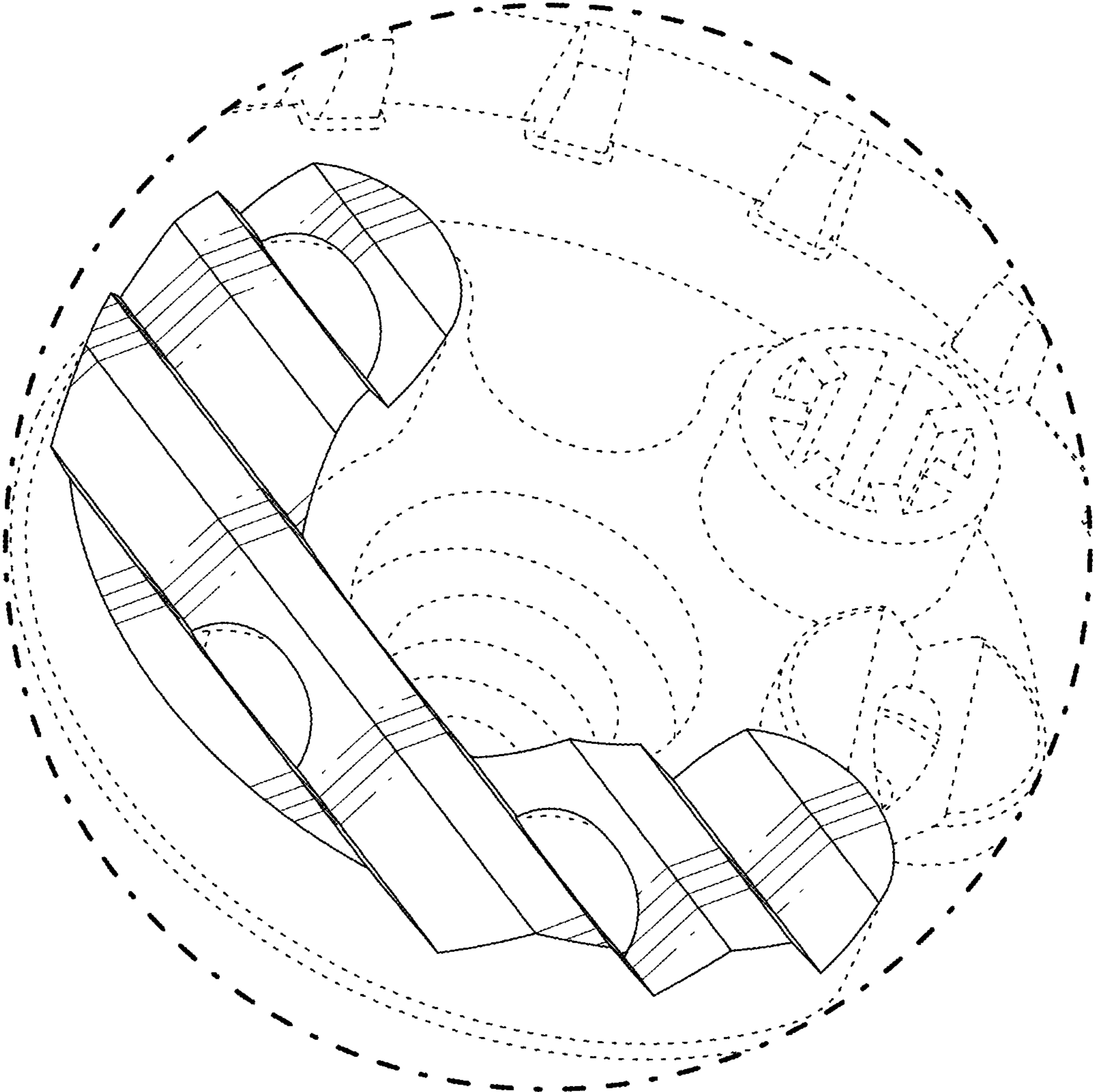


**FIG. 3**



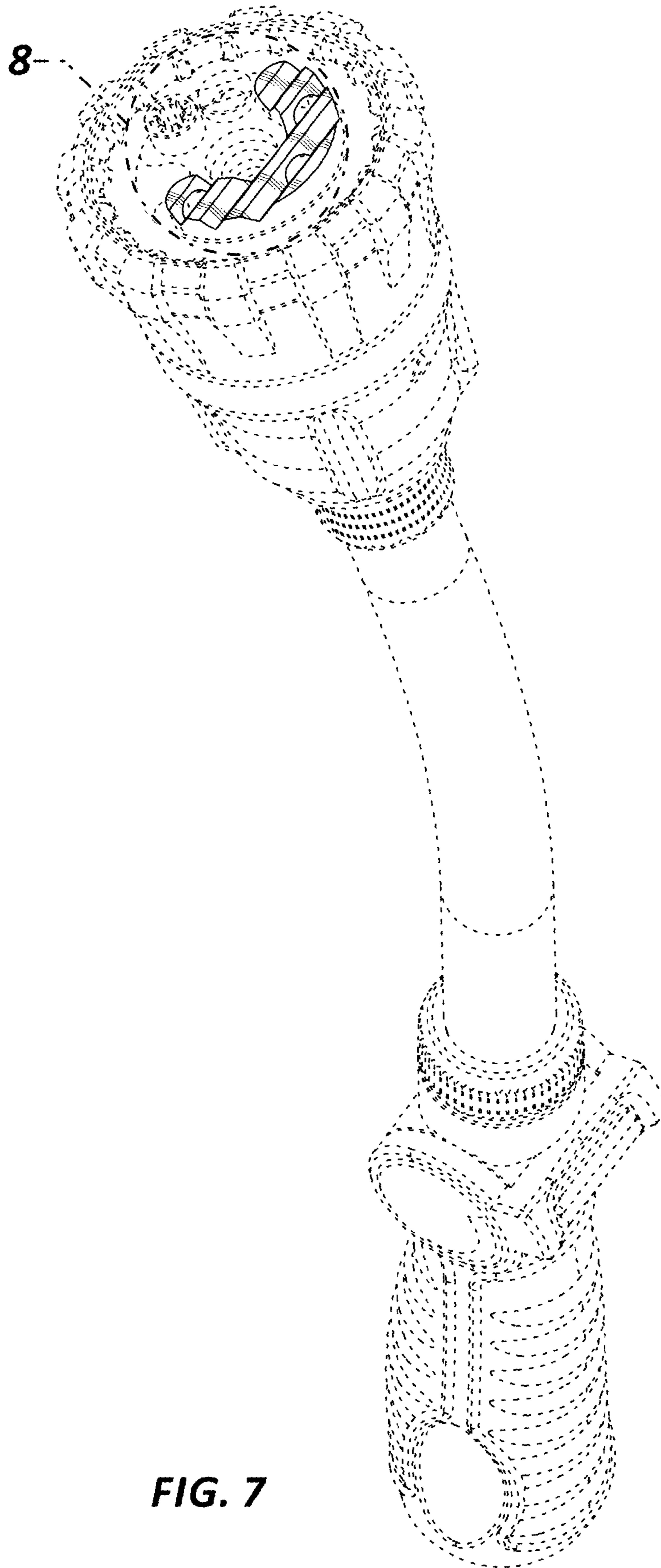
**FIG. 4**



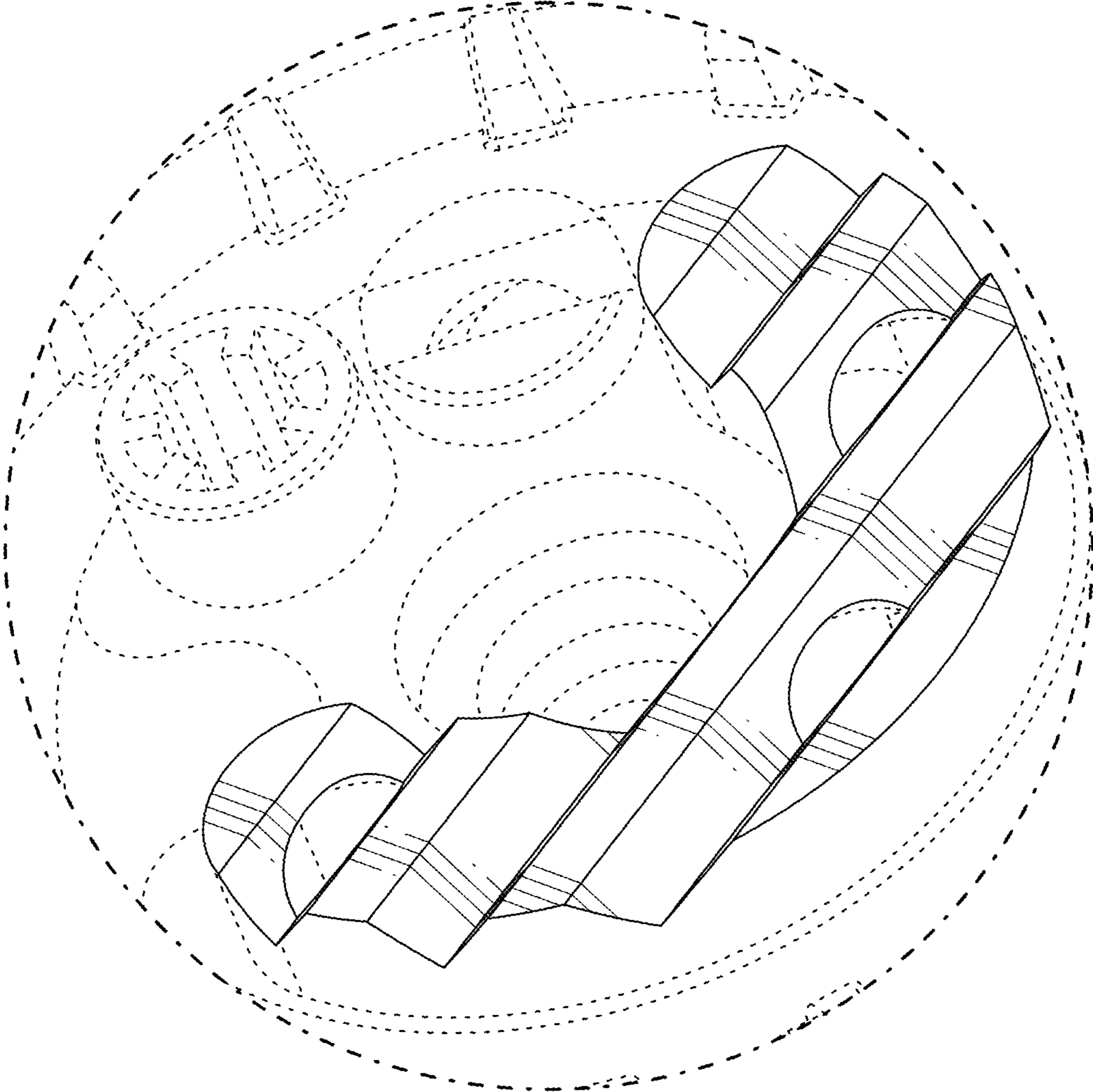


**FIG. 6**

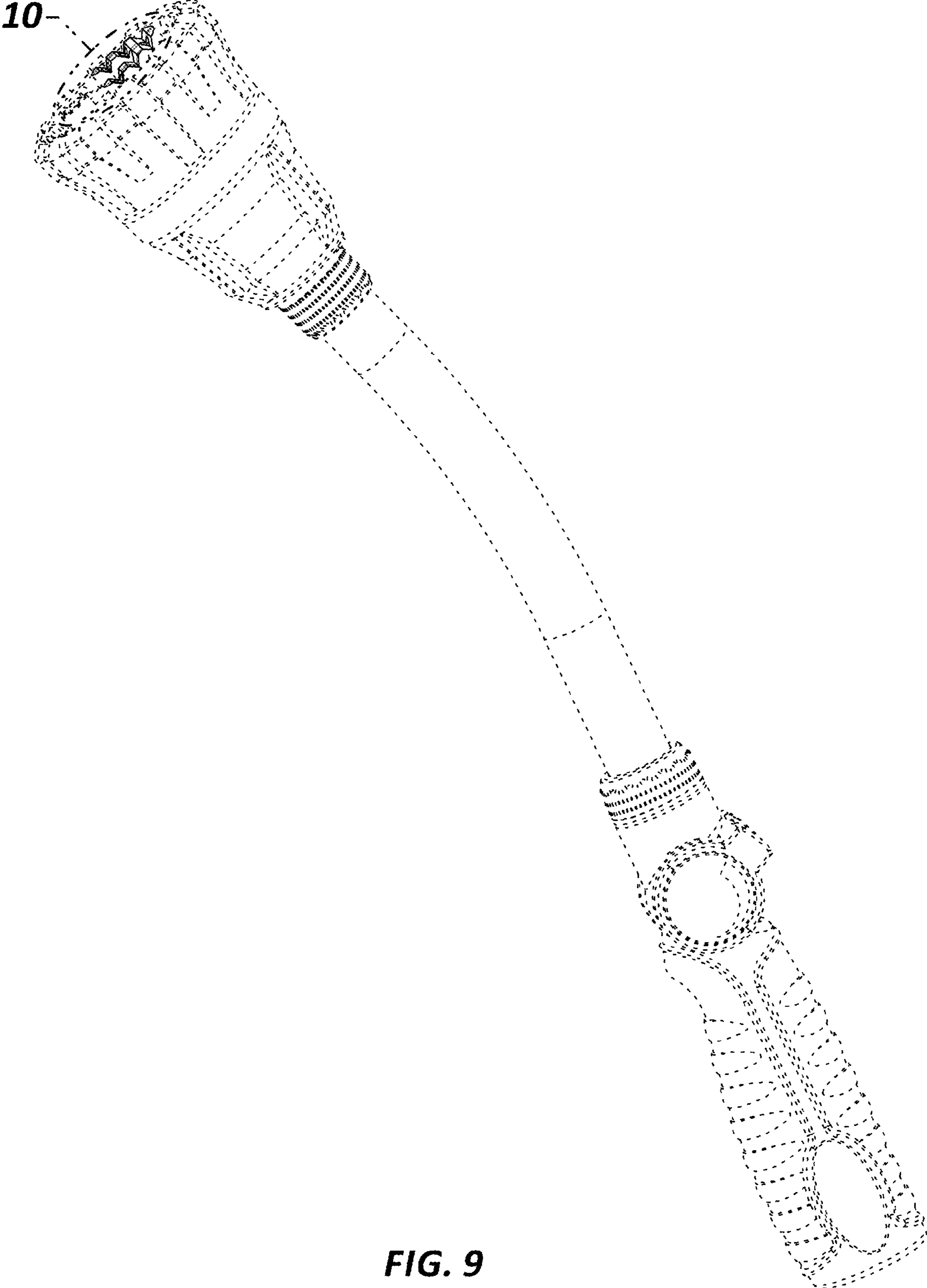




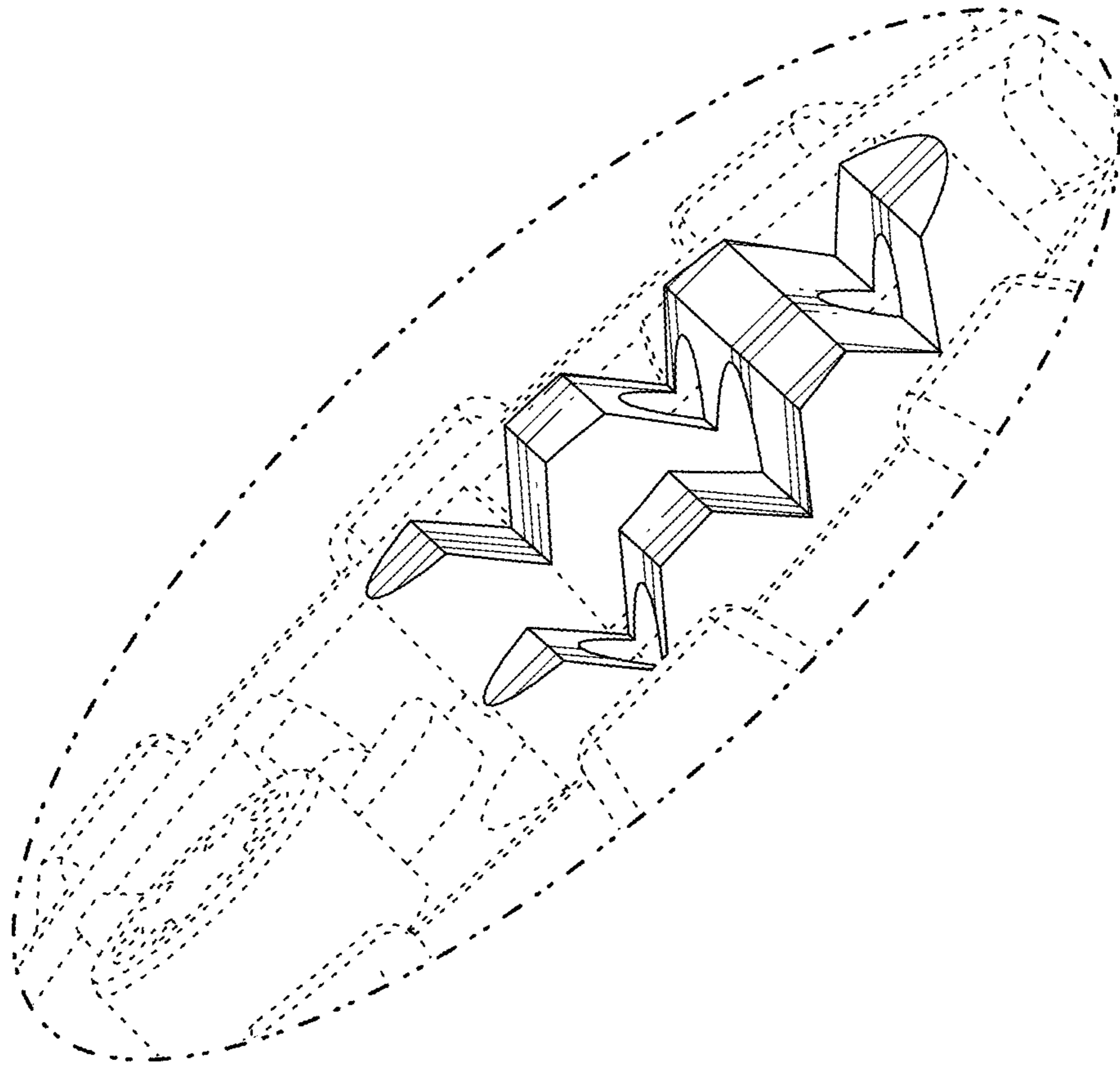
**FIG. 7**



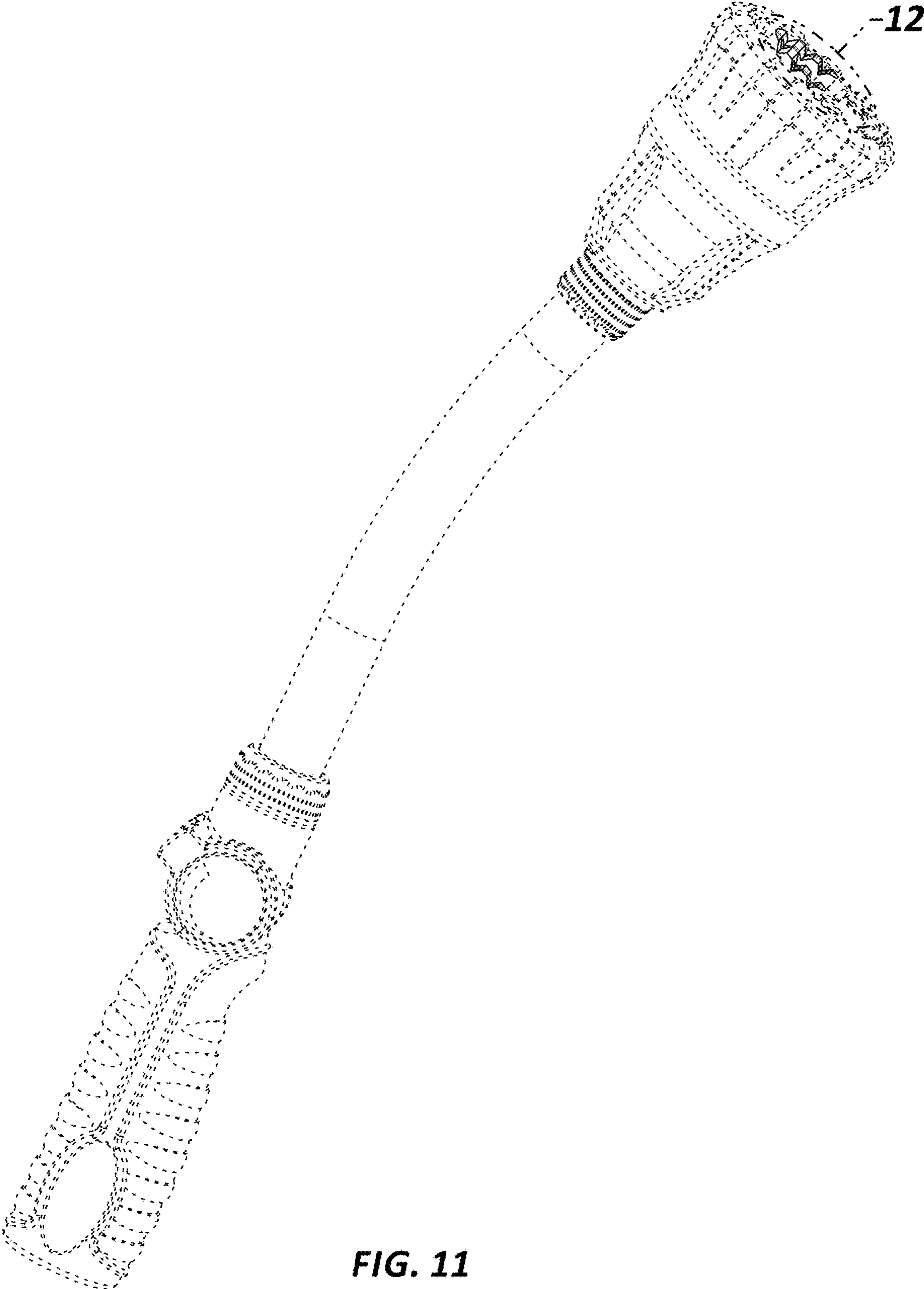
**FIG. 8**



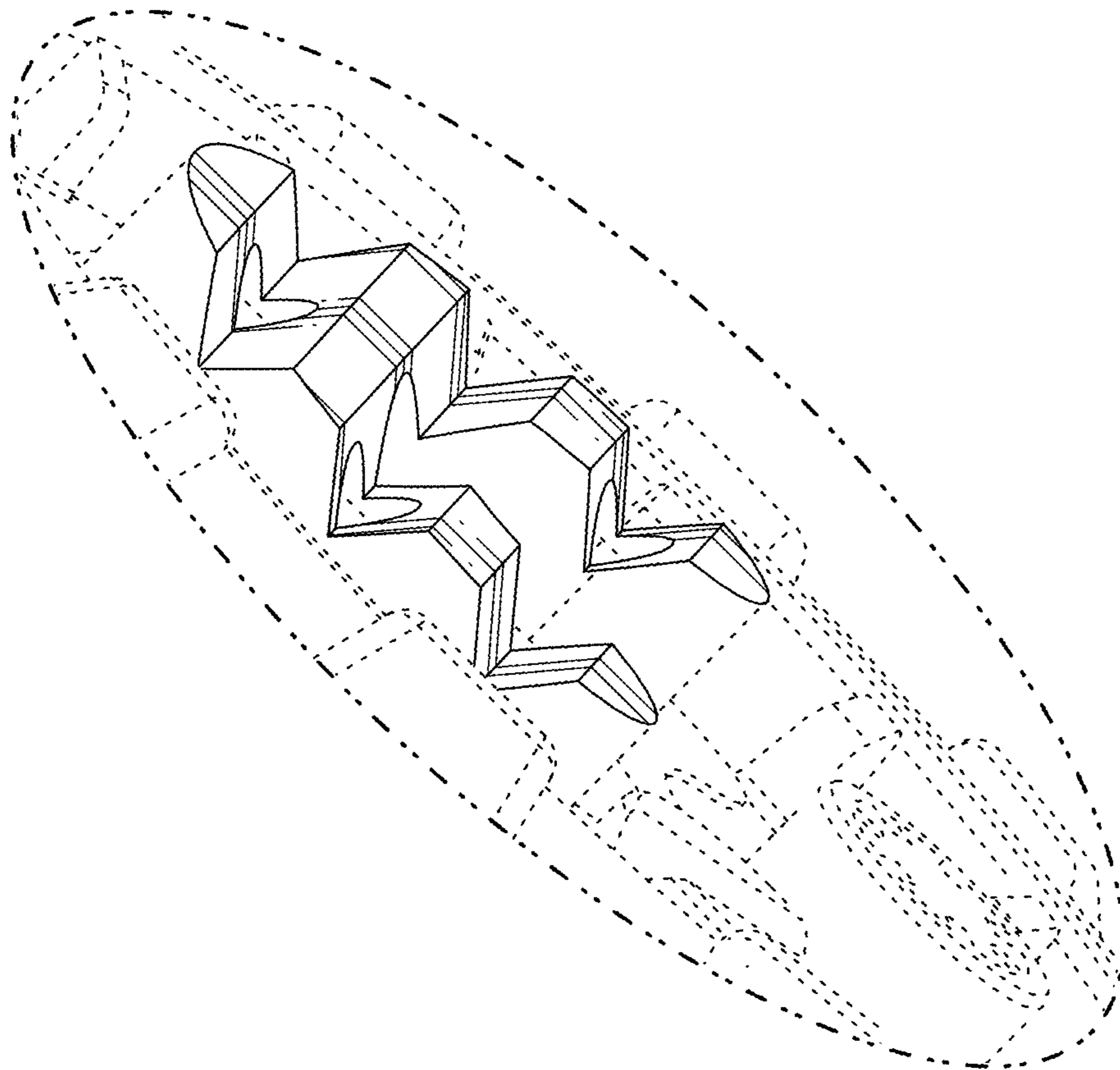
**FIG. 9**



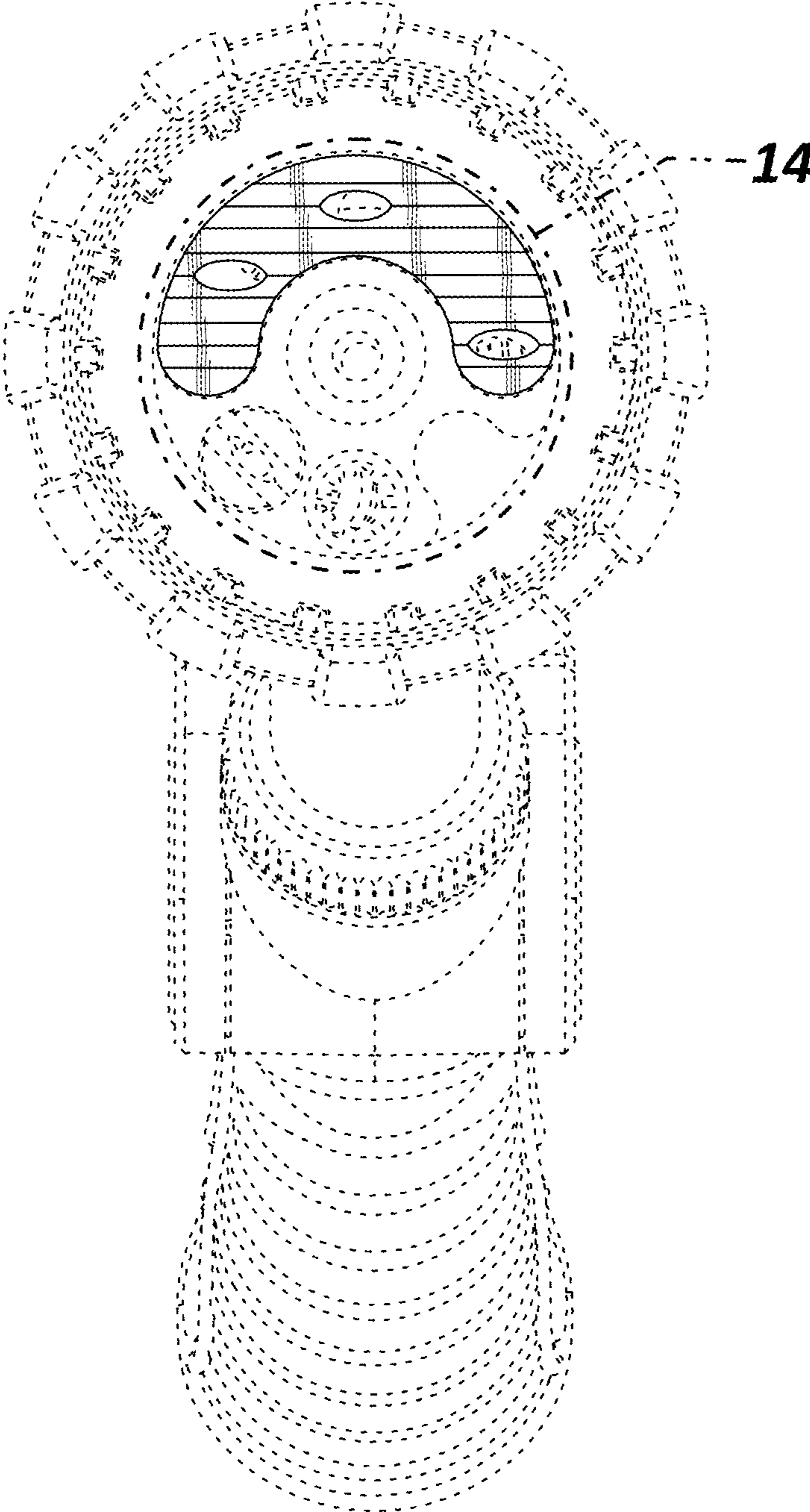
**FIG. 10**



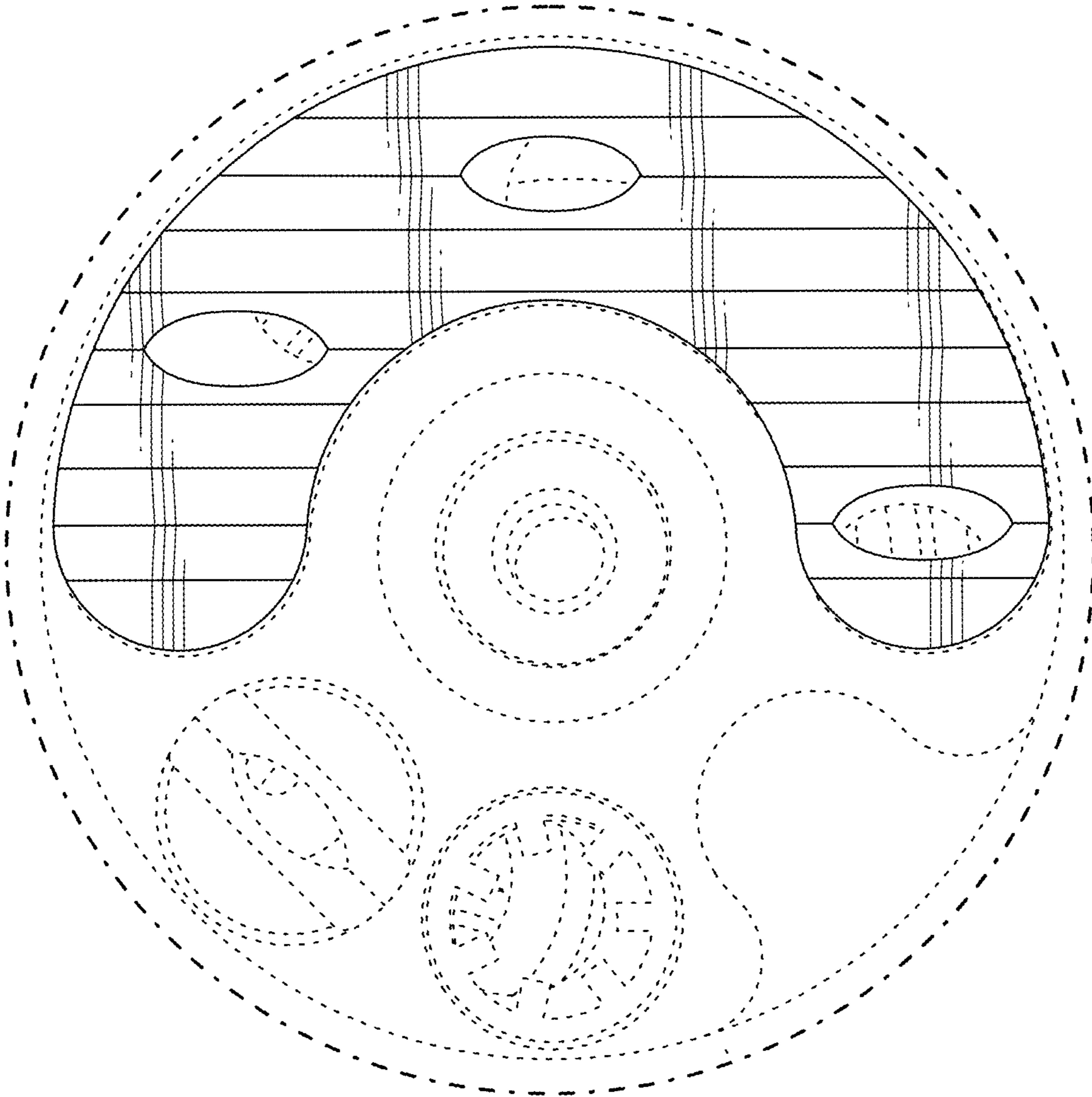
**FIG. 11**



**FIG. 12**



**FIG. 13**



**FIG. 14**