



US00D941953S

(12) **United States Design Patent** (10) **Patent No.:** **US D941,953 S**
English (45) **Date of Patent:** **** Jan. 25, 2022**

(54) **BAIT TRAY**

(71) Applicant: **Gary H. English**, Clearwater, FL (US)

(72) Inventor: **Gary H. English**, Clearwater, FL (US)

(**) Term: **15 Years**

(21) Appl. No.: **29/749,016**

(22) Filed: **Sep. 2, 2020**

(51) **LOC (13) Cl.** **22-05**

(52) **U.S. Cl.**
USPC **D22/136**

(58) **Field of Classification Search**
USPC D22/136, 134, 121, 147, 145; D32/53,
D32/53.1, 54, 71

CPC A01K 93/02; A01K 97/02; A01K 97/04;
A01K 97/05; A01K 95/00; A01K 93/00;
B44D 3/12

See application file for complete search history.

(56) **References Cited**

U.S. PATENT DOCUMENTS

- 3,304,645 A * 2/1967 Hardesty A01K 97/05
43/55
- 5,931,019 A 8/1999 White et al.
- 6,062,389 A * 5/2000 Kent B44D 3/12
D32/53.1
- 6,726,050 B1 4/2004 Barentine et al.
- 7,155,859 B1 1/2007 Brooks
- 7,389,608 B1 6/2008 MacKay
- D601,654 S 10/2009 Sykes
- D631,937 S * 2/2011 Sykes D22/136
- 8,028,468 B1 10/2011 Walsh et al.
- 8,839,965 B2 9/2014 Benneche et al.
- 9,108,790 B2 8/2015 Daley
- 10,066,863 B2 9/2018 Smith
- D892,260 S * 8/2020 Poston D22/136

OTHER PUBLICATIONS

Max Bait Tray Deep 22.5"×12.5"×3.9" Fits YETI 105 . . . <https://alltackle.com/max-bait-tray-22-5-x-12-5-x-3-9-deep-tray/?gclid=>

EAlalQobChMl2eqU9qS98wIVQeG1Ch2BgAOQEAQYASA-BEglVcPD_BwE (Year: 2021).*

Plano Worm Stowaway 3700 Utility Box—Clear . . . https://www.cabelas.com/shop/en/plano-worm-stowaway-3700-utility-box?ds_e=GOOGLE&ds_c=Shop%7CGeneric%7CAIIPProducts%7CHigh%7CSSCCatchAll&gclid=

EAlalQobChMlsvXQtKa98wIVA5SzCh01rQ9fEAQYASABEgKQ6vD_BwE&gclid=aw.ds (Year: 2021).*

Clear Compartment Serving Tray . . . <https://www.birthdayexpress.com/products/clear-compartment-serving-tray?code=googlepla&gclid=>

EAlalQobChMlopF2zqe98wIVu-y1Ch1MQAZpEAQYASABEgLtvD_BwE (Year: 2021).*

Bait Tray with Plug Cutter. Product Listing [online]. Copyright © 2020 All Rights Reserved Fish Fighter® Products [retrieved on Jun. 1, 2020]. Retrieved from the Internet: <URL: <http://fishfighterproducts.com/shop/bait-tray-with-plug-cutter/>>.

Best Bait Cutting Boards for Boats: Prep, Fillet & Cut Bait. Article [online]. © The Coastal Side by Markus [retrieved on Jun. 1, 2020]. Retrieved from the Internet: <URL: <https://thecoastalside.com/best-bait-boards/>>.

* cited by examiner

Primary Examiner — Catherine R Oliver-Garcia
(74) *Attorney, Agent, or Firm* — Cramer Patent & Design, PLLC; Aaron R. Cramer

(57) **CLAIM**

The ornamental design for a bait tray, as shown and described.

DESCRIPTION

FIG. 1 is a perspective top front right view of a bait tray, showing my new design;
FIG. 2 is a perspective top rear left view thereof;
FIG. 3 is a front elevation view thereof;
FIG. 4 is a rear elevation view thereof;
FIG. 5 is a right elevation view thereof;
FIG. 6 is a left elevation view thereof;
FIG. 7 is a top plan view thereof; and,
FIG. 8 is a bottom plan view thereof.

1 Claim, 6 Drawing Sheets

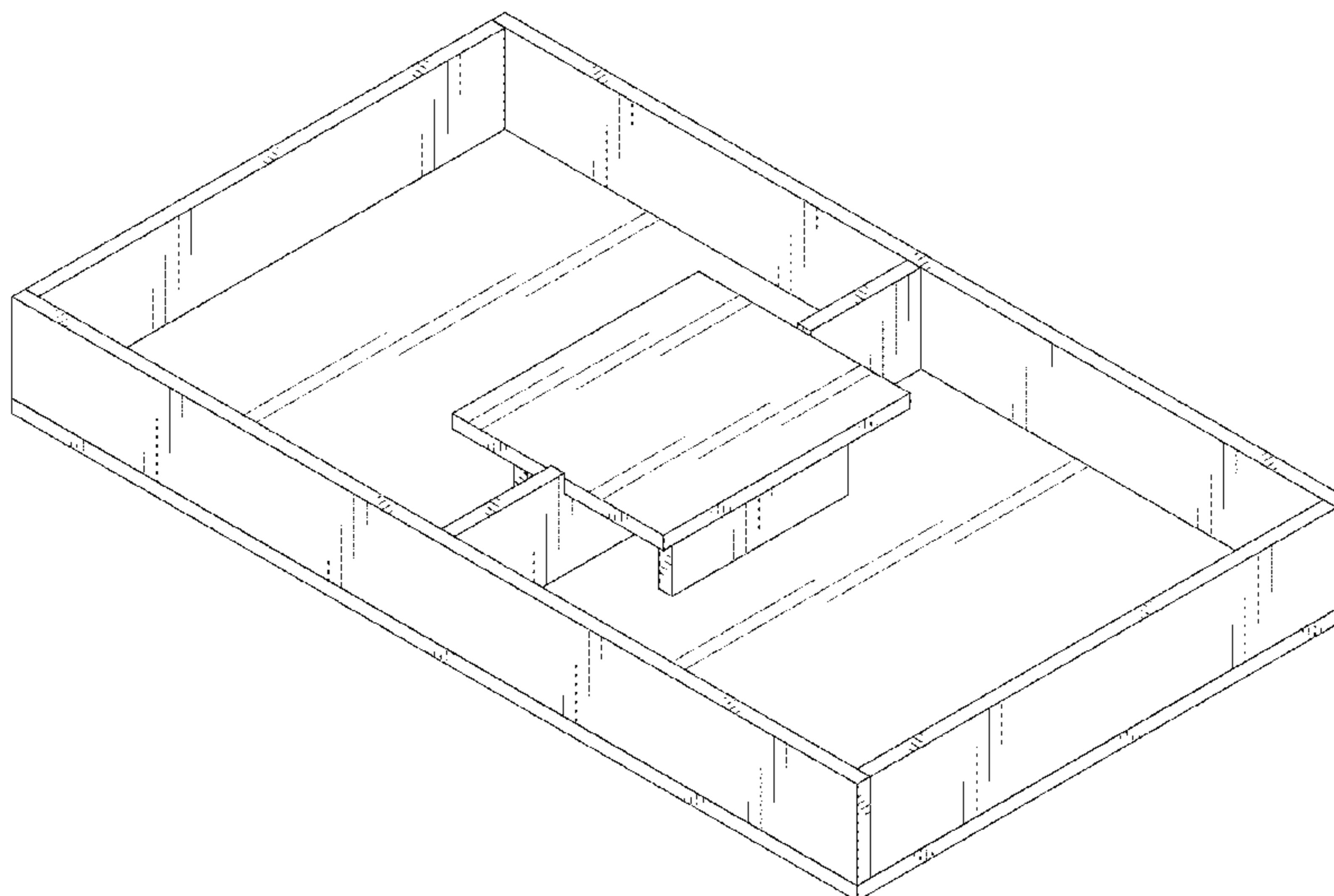

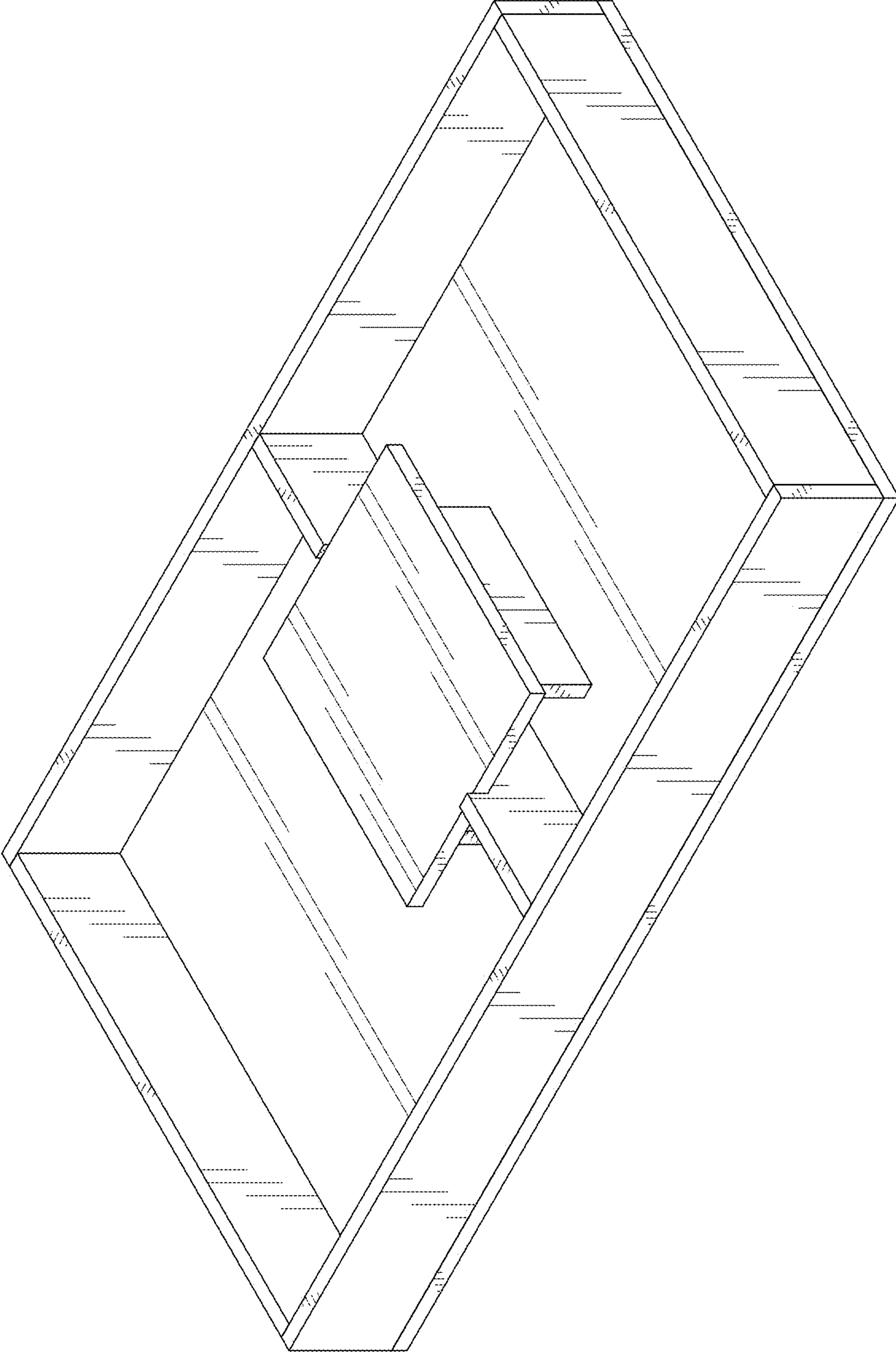

FIG. 1

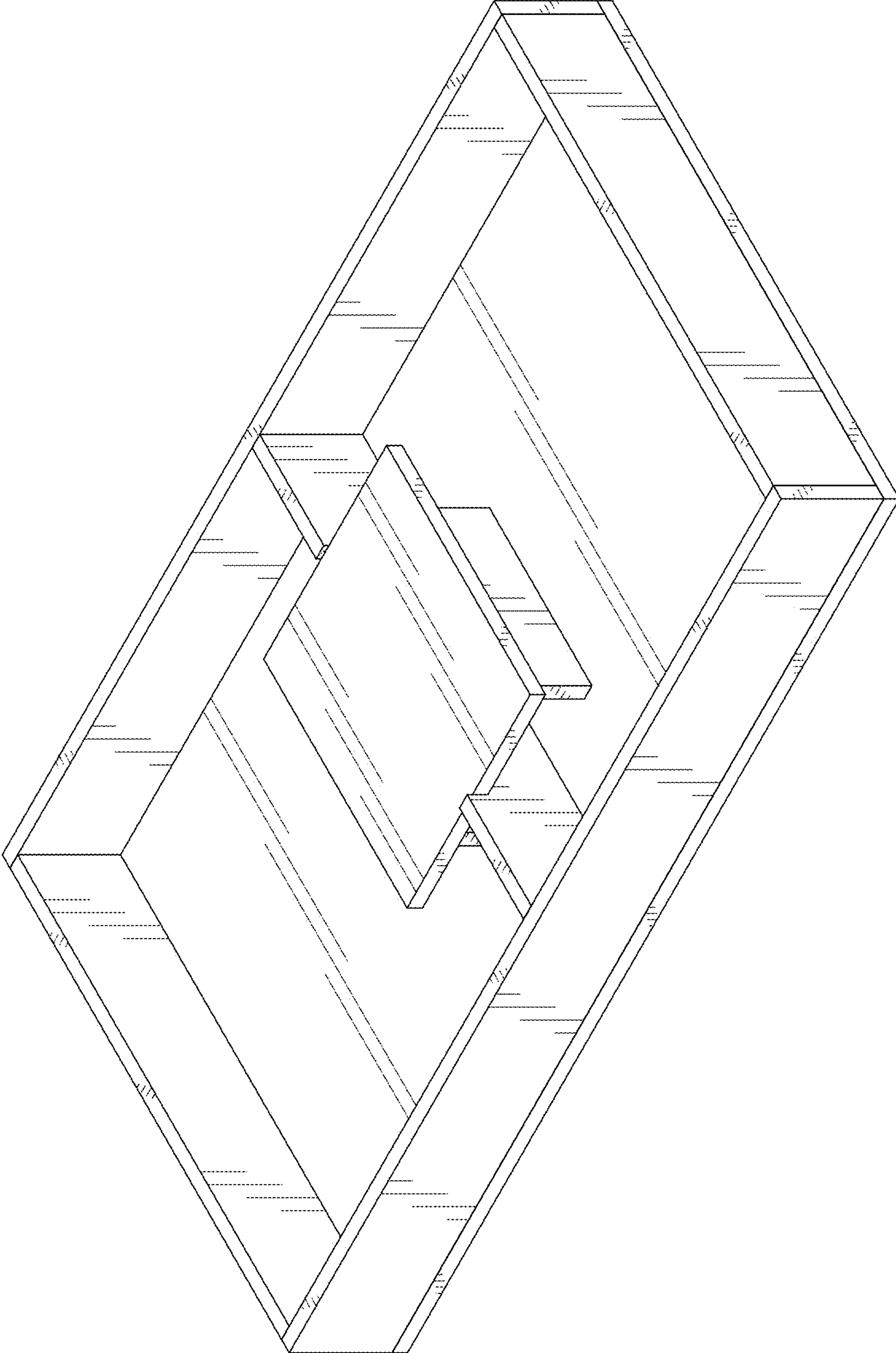

FIG. 2

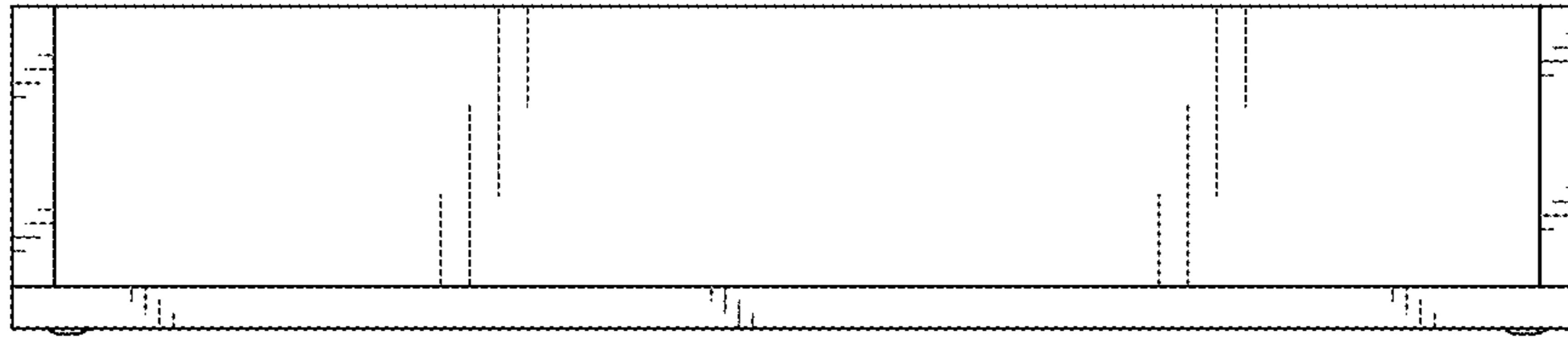

FIG. 3



FIG. 4

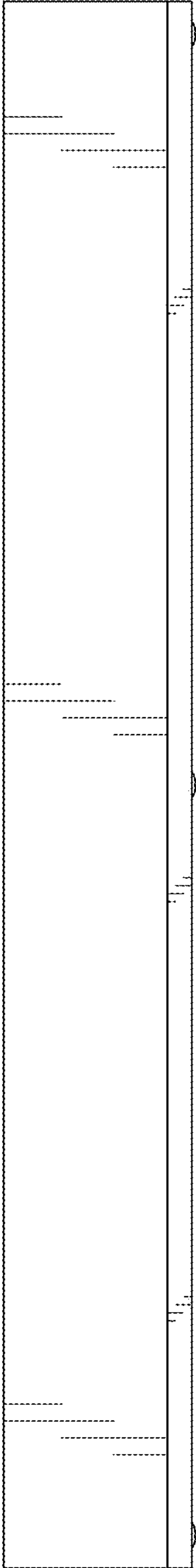

FIG. 5

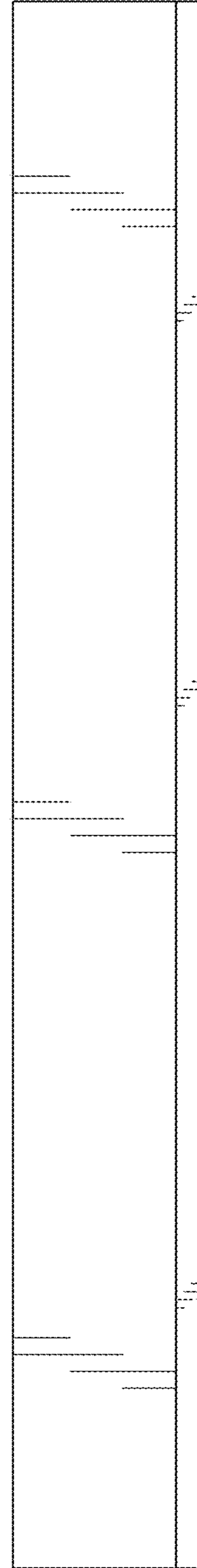

FIG. 6

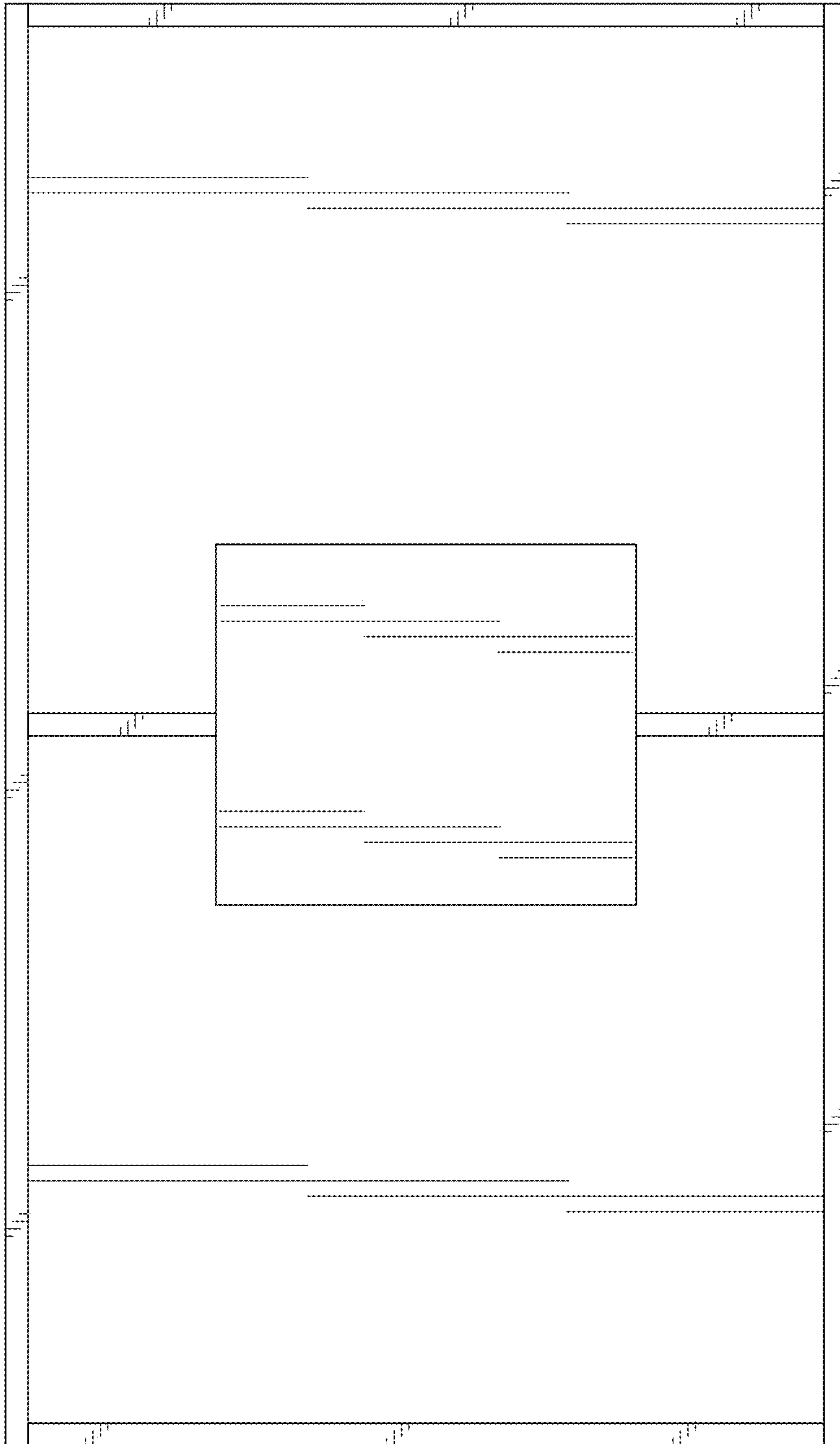

FIG. 7

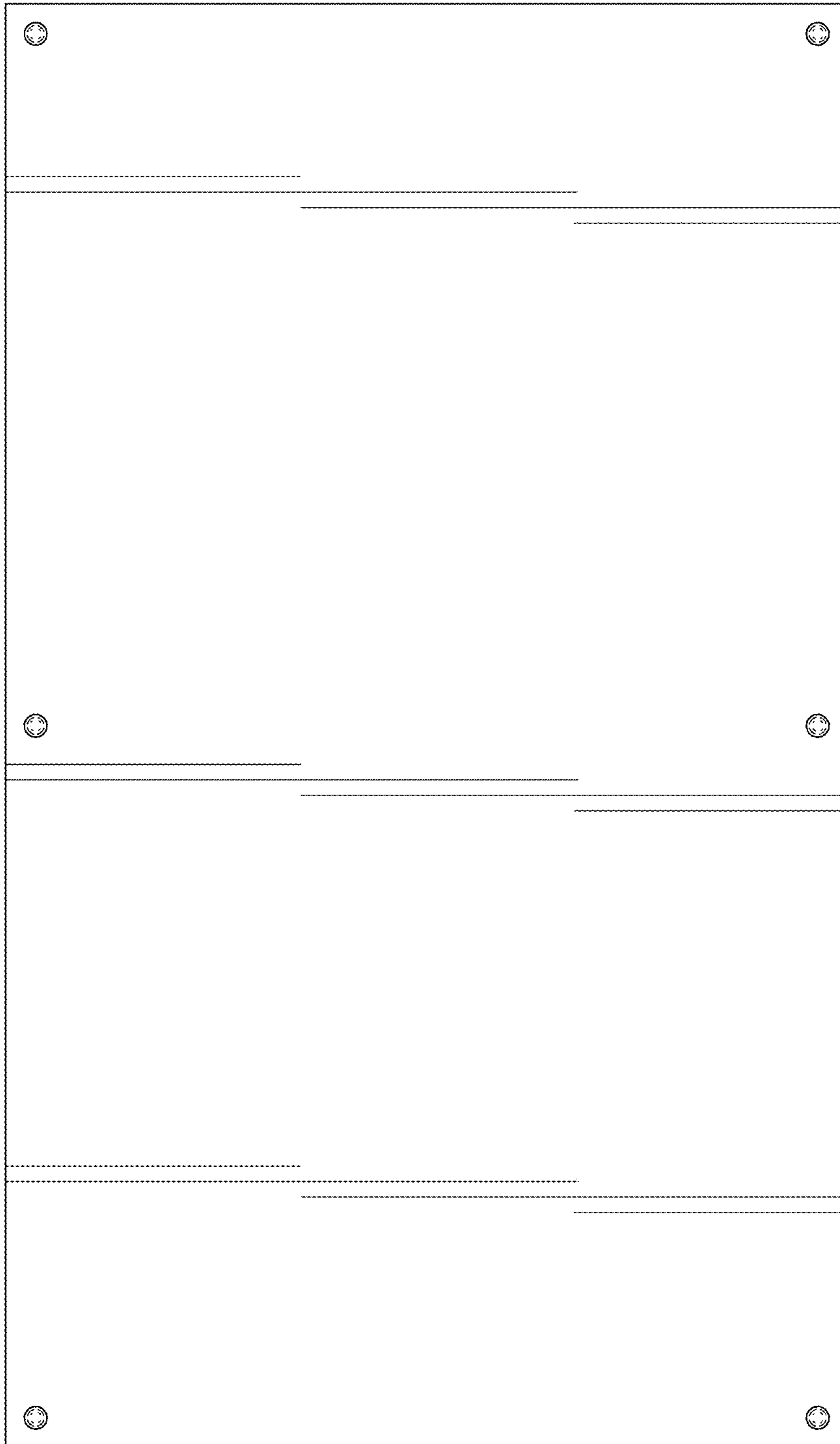

FIG. 8