



US00D941925S

(12) **United States Design Patent**
Peeters et al.

(10) **Patent No.:** **US D941,925 S**
(45) **Date of Patent:** **** Jan. 25, 2022**

(54) **GAME BOARD AND GAME PIECES**

(71) Applicant: **SMART N.V.**, Kontich (BE)

(72) Inventors: **Raf Peeters**, Lier (BE); **Leighton Meredith Rees**, Cirencester (GB)

(73) Assignee: **SMART N.V.**, Kontich (BE)

(**) Term: **15 Years**

(21) Appl. No.: **29/688,249**

(22) Filed: **Apr. 19, 2019**

(30) **Foreign Application Priority Data**

Oct. 30, 2018 (EM) 005813094

(51) **LOC (13) Cl.** **21-01**

(52) **U.S. Cl.**

USPC **D21/336**

(58) **Field of Classification Search**

USPC D21/334, 335-342, 355-359, 365, 318,
D21/397, 351, 385, 386, 389, 404, 478,
D21/479, 483-486, 489-491, 493, 494,
D21/497, 499, 507, 510, 511, 561;
273/241, 242, 244-247, 259, 275-277,
273/281, 282.1-282.3, 284, 287, 317.3,
273/108.1, 108.5, 118 D, 236-240, 283,
273/309, 441, 461; D6/406.1, 406.3,
D6/406.4, 406.6; D19/86, 92, 95, 87,
D19/113, 75, 77, 78, 80; 108/14, 62, 43,
108/67; 434/416, 247, 248, 251, 408,
434/413, 145, 430

CPC A63F 2003/00974; A63F 7/00; A63F 7/06;
A63F 7/0612; A63F 7/0604; A63F
7/0616-0636; A63F 7/30; A63F 7/36;
A63F 7/0005; A63F 7/0017; A63F
7/0023; A63F 2007/0035; A63F
2007/367; A63F 2007/3674; A63F 9/00;
A63F 9/08; A63F 9/001; A63F 9/0826;
A63F 9/0073; A63F 9/0078; A63F
9/0602; A63F 9/0613; A63F 9/12-1208;
A63F 9/1288; A63F 2009/0012; A63F

2009/1212-1228; A63F 2009/1292; A63F
2009/1296; A63F 3/00; A63F 3/00003;
A63F 3/00028; A63F 3/00041; A63F
3/00047; A63F 3/00173; A63F 3/00176;
A63F 3/00214; A63F 3/00261; A63F
3/00643; A63F 3/00646-00659; A63F
3/04; A63F 3/00097; A63F 3/0434; A63F
3/00148; A63F 3/00697; A63F 3/0023;
A63F 3/00895; A63F 3/00574; A63F
3/00694; A63F 2003/00182; A63F
2003/00223; A63F 2003/00457; A63F
2003/0046; A63F 2003/00463; A63F
2003/00466; A63F 2003/0047; A63F
2003/00485; A63F 2003/00492; A63F
2003/00507; A63F 2003/00514; A63F
2003/00533; A63F 2003/00552; A63F
2003/00558; A63F 2003/00943; A63F
2003/00946; A63F 2003/00952-00962

See application file for complete search history.

(56)

References Cited

U.S. PATENT DOCUMENTS

D195,416 S * 6/1963 Markham D21/336
3,602,514 A * 8/1971 Peebles A63F 3/00574
273/290
D223,939 S * 6/1972 Palazzolo D21/336
3,692,310 A * 9/1972 Martin A63F 9/12
273/241
3,804,415 A * 4/1974 Ryan A63F 3/00697
273/275
4,021,045 A * 5/1977 Mermelstein A63F 3/0023
273/282.1
4,147,358 A * 4/1979 Erickson A63F 3/00
273/241
D259,644 S * 6/1981 Israel D21/336
D266,728 S * 11/1982 Ivy D7/693
D267,023 S * 11/1982 Bowser D21/336
D268,353 S * 3/1983 Pilipski D21/336
D268,770 S * 4/1983 Fiveash D21/337
D274,885 S * 7/1984 Joice D9/758
4,552,363 A * 11/1985 Rehkemper A63F 9/12
273/241
4,696,476 A * 9/1987 Eplett A63F 3/00214
273/241
4,696,477 A * 9/1987 Tsuzuki A63F 9/30
273/241

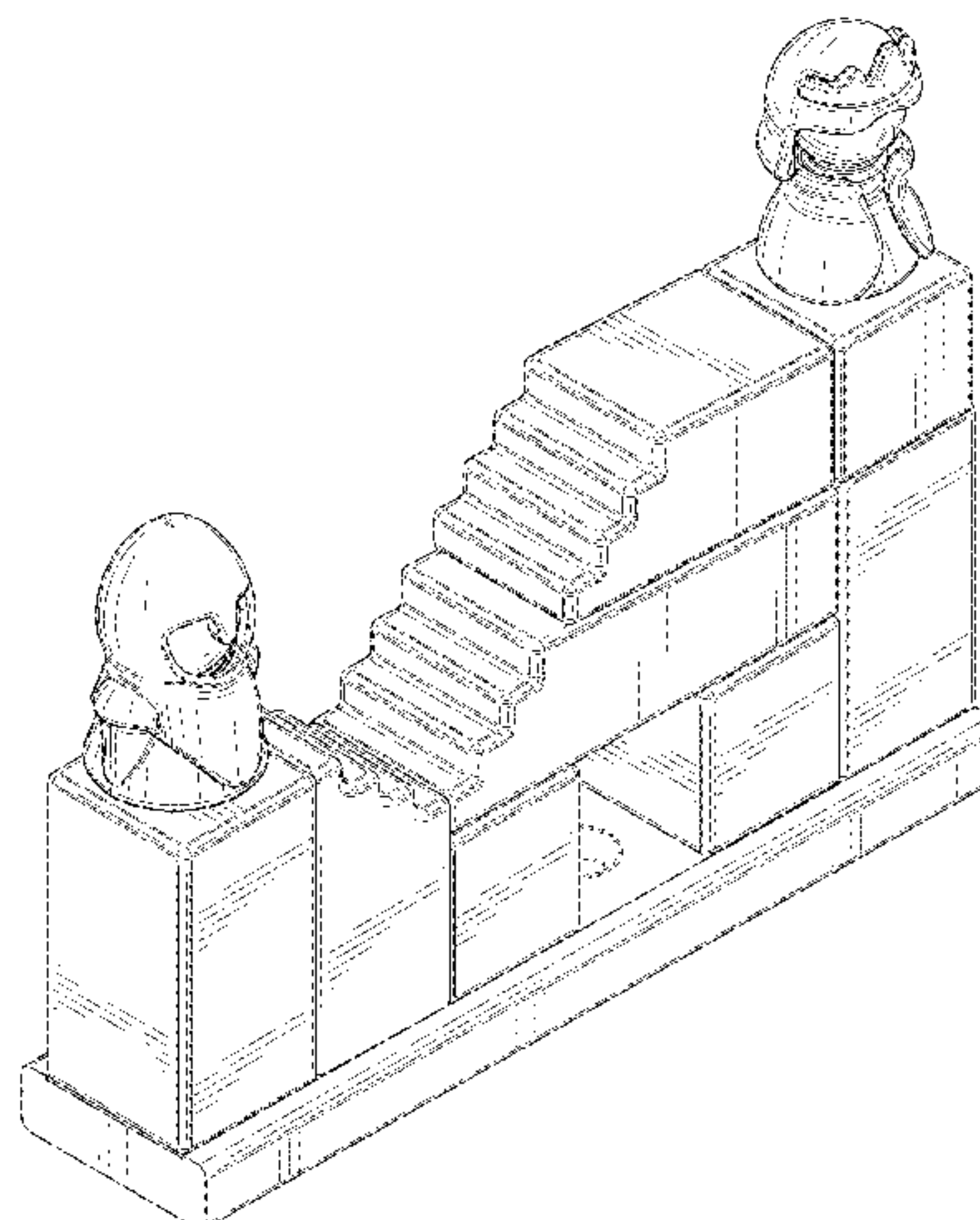

4,776,597	A *	10/1988	Rudell	A63F 3/0423	273/241
D299,933	S *	2/1989	Shalaon	D21/336	
D321,431	S *	11/1991	Dunkeld	D12/419	
5,102,144	A *	4/1992	Dickerman	A63F 3/00214	273/237
D363,091	S *	10/1995	Dobis	D21/336	
5,660,388	A *	8/1997	Benn	A63F 3/00214	273/241
6,257,575	B1 *	7/2001	Ortega	A63F 3/00214	273/241
6,893,020	B1 *	5/2005	Snyder	A63F 9/20	273/287
D519,303	S *	4/2006	Winig	D6/682.2	
D526,027	S *	8/2006	Smith	D21/336	
D539,359	S *	3/2007	Rom	D21/478	
7,219,895	B1 *	5/2007	Hutchins, Jr.	A63F 3/02	273/236
D589,626	S *	3/2009	Petersen	D24/230	
D596,758	S *	7/2009	Constable	D24/230	
D660,917	S *	5/2012	Flowers	D21/349	
D661,950	S *	6/2012	Greenwood	D7/590	
8,302,801	B2 *	11/2012	Fried	B65D 21/086	220/508
D674,709	S *	1/2013	Akana	D9/737	
D678,409	S *	3/2013	Papenfu	D19/106	
D685,654	S *	7/2013	Akana	D9/737	
D690,164	S *	9/2013	Lock	D7/553.2	
D692,501	S *	10/2013	Flowers	D21/339	
D695,078	S *	12/2013	Hertaus	D7/600.1	
D709,323	S *	7/2014	Brown	D7/402	
D713,051	S *	9/2014	Smeja	D24/230	
D714,958	S *	10/2014	Smeja	D24/230	
D729,549	S *	5/2015	Williams	D6/675	
D734,867	S *	7/2015	Smeja	D24/230	
D736,403	S *	8/2015	Hudson	D24/226	
D739,680	S *	9/2015	Smeja	D7/600.1	
D742,666	S *	11/2015	Akana	D6/682.2	
D744,159	S *	11/2015	Lukas	D27/183	
D746,637	S *	1/2016	Mairinger	D7/553.2	
D767,309	S *	9/2016	Akana	D6/682.2	
D769,678	S *	10/2016	Jussen	D7/701	
D785,406	S *	5/2017	Wansink	D7/553.2	
D789,749	S *	6/2017	Tsai	D7/600.1	
D789,750	S *	6/2017	Noe	D7/600.1	
D793,813	S *	8/2017	Dubois	D7/553.2	
D793,856	S *	8/2017	Akana	D9/425	
D795,704	S *	8/2017	Tanus	D9/737	
9,788,913	B2 *	10/2017	Ghosh	A61B 46/00	
D802,678	S *	11/2017	Wimer	D21/336	
D813,953	S *	3/2018	Stead	D21/348	
D911,450	S *	2/2021	Peeters	D21/336	
D912,156	S *	3/2021	Peeters	D21/335	
2005/0258594	A1 *	11/2005	Steenstra	A63F 9/1288	273/241
2012/0098196	A1 *	4/2012	Roberts	A63F 3/00533	273/287
2013/0341868	A1 *	12/2013	Vandoren	A63H 33/042	273/290

* cited by examiner

Primary Examiner — Susan Moon Lee
 (74) Attorney, Agent, or Firm — Hodgson Russ LLP

(57) **CLAIM**

The ornamental design for a game board and game pieces, as shown and described.

DESCRIPTION

FIG. 1 is a top perspective view of a Game Board and Game Pieces according to the present design, showing the game board apart from the game pieces for clarity of illustration;

FIG. 2 is a front elevational view of the game board of FIG. 1;
 FIG. 3 is a rear elevational view of the game board of FIG. 1;
 FIG. 4 is a right side view of the game board of FIG. 1;
 FIG. 5 is a left side view of the game board of FIG. 1;
 FIG. 6 is a top view of the game board of FIG. 1;
 FIG. 7 is a bottom view of the game board of FIG. 1;
 FIG. 8 is a top perspective view of a game piece component, shown separately for clarity of illustration;
 FIG. 9 is a front elevational view of the game piece of FIG. 8;
 FIG. 10 is a rear elevational view of the game piece of FIG. 8;
 FIG. 11 is a right side view of the game piece of FIG. 8;
 FIG. 12 is a left side view of the game piece of FIG. 8;
 FIG. 13 is a top view of the game piece of FIG. 8;
 FIG. 14 is a bottom view of the game piece of FIG. 8;
 FIG. 15 is a top perspective view of a game piece, shown separately for clarity of illustration;
 FIG. 16 is a front elevational view of the game piece of FIG. 15;
 FIG. 17 is a rear elevational view of the game piece of FIG. 15;
 FIG. 18 is a right side view of the game piece of FIG. 15;
 FIG. 19 is a left side view of the game piece of FIG. 15;
 FIG. 20 is a top view of the game piece of FIG. 15;
 FIG. 21 is a bottom view of the game piece of FIG. 15;
 FIG. 22 is a top perspective view of a game piece, shown separately for clarity of illustration;
 FIG. 23 is a front elevational view of the game piece of FIG. 22;
 FIG. 24 is a rear elevational view of the game piece of FIG. 22;
 FIG. 25 is a right side view of the game piece of FIG. 22;
 FIG. 26 is a left side view of the game piece of FIG. 22;
 FIG. 27 is a top view of the game piece of FIG. 22;
 FIG. 28 is a bottom view of the game piece of FIG. 22;
 FIG. 29 is a top perspective view of a game piece, shown separately for clarity of illustration;
 FIG. 30 is a front elevational view of the game piece of FIG. 29;
 FIG. 31 is a rear elevational view of the game piece of FIG. 29;
 FIG. 32 is a right side view of the game piece of FIG. 29;
 FIG. 33 is a left side view of the game piece of FIG. 29;
 FIG. 34 is a top view of the game piece of FIG. 29;
 FIG. 35 is a bottom view of the game piece of FIG. 29;
 FIG. 36 is a top perspective view of a game piece, shown separately for clarity of illustration;
 FIG. 37 is a front elevational view of the game piece of FIG. 36;
 FIG. 38 is a rear elevational view of the game piece of FIG. 36;
 FIG. 39 is a right side view of the game piece of FIG. 36;
 FIG. 40 is a left side view of the game piece of FIG. 36;
 FIG. 41 is a top view of the game piece of FIG. 36;
 FIG. 42 is a bottom view of the game piece of FIG. 36;
 FIG. 43 is a top perspective view of a game piece, shown separately for clarity of illustration;
 FIG. 44 is a front elevational view of the game piece of FIG. 43;
 FIG. 45 is a rear elevational view of the game piece of FIG. 43;
 FIG. 46 is a right side view of the game piece of FIG. 43;

FIG. 47 is a left side view of the game piece of FIG. 43;
FIG. 48 is a top view of the game piece of FIG. 43;
FIG. 49 is a bottom view of the game piece of FIG. 43;
FIG. 50 is a top perspective view of a game piece, shown separately for clarity of illustration;
FIG. 51 is a front elevational view of the game piece of FIG. 50;
FIG. 52 is a rear elevational view of the game piece of FIG. 50;
FIG. 53 is a right side view of the game piece of FIG. 50;
FIG. 54 is a left side view of the game piece of FIG. 50;
FIG. 55 is a top view of the game piece of FIG. 50;
FIG. 56 is a bottom view of the game piece of FIG. 50;
FIG. 57 is a top perspective view of a game piece, shown separately for clarity of illustration; and
FIG. 58 is a front elevational view of the game piece of FIG. 57;
FIG. 59 is a rear elevational view of the game piece of FIG. 57;
FIG. 60 is a right side view of the game piece of FIG. 57;
FIG. 61 is a left side view of the game piece of FIG. 57;
FIG. 62 is a top view of the game piece of FIG. 57;
FIG. 63 is a bottom view of the game piece of FIG. 57; and,
FIG. 64 is a top perspective view of the game board and game pieces.

The evenly-dashed broken lines in the drawings illustrate the portions of the game pieces and game board that form no part of the claim.

1 Claim, 37 Drawing Sheets

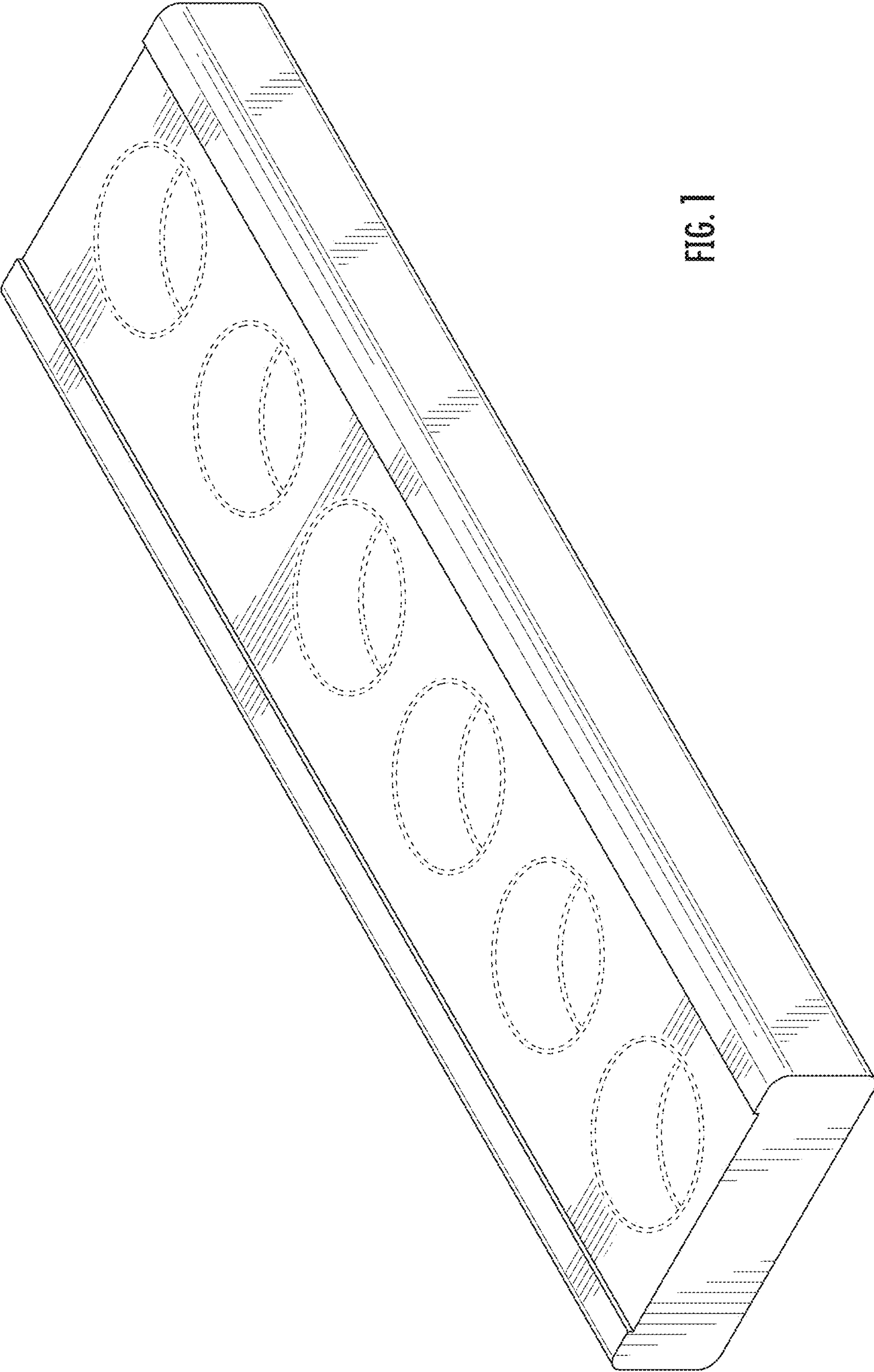

FIG. 1

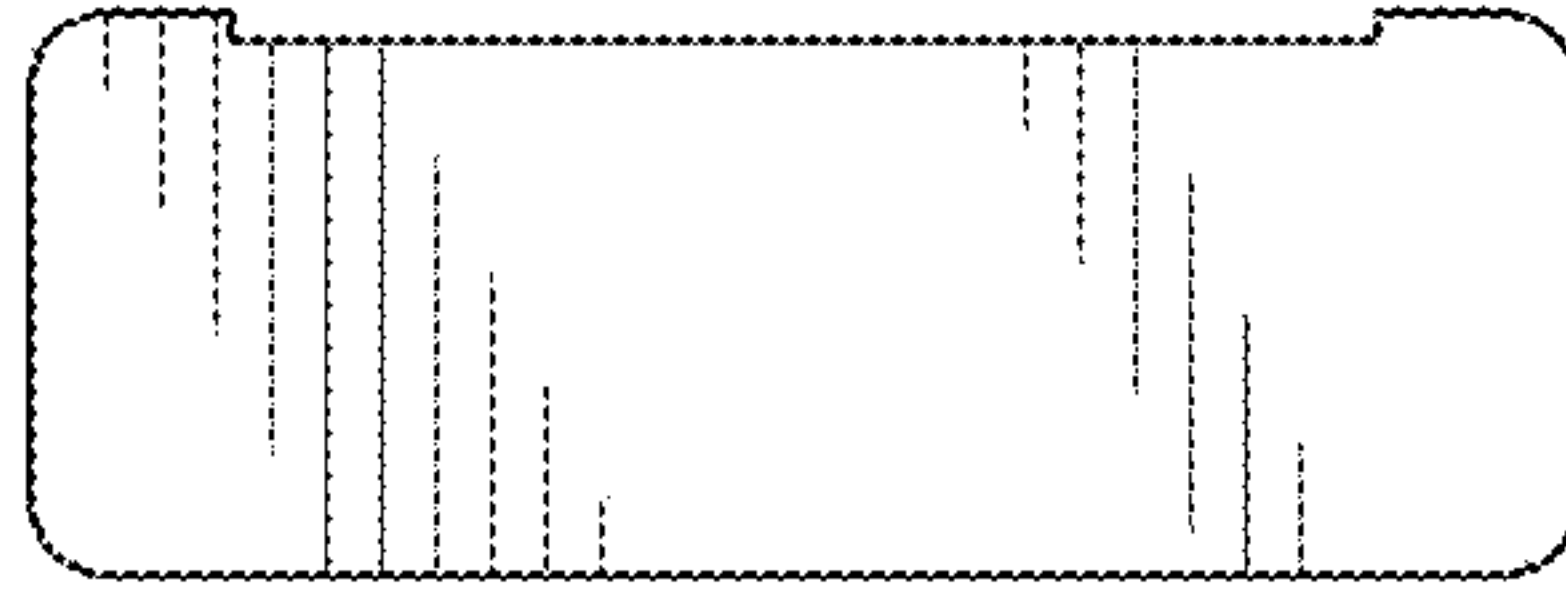

FIG. 2

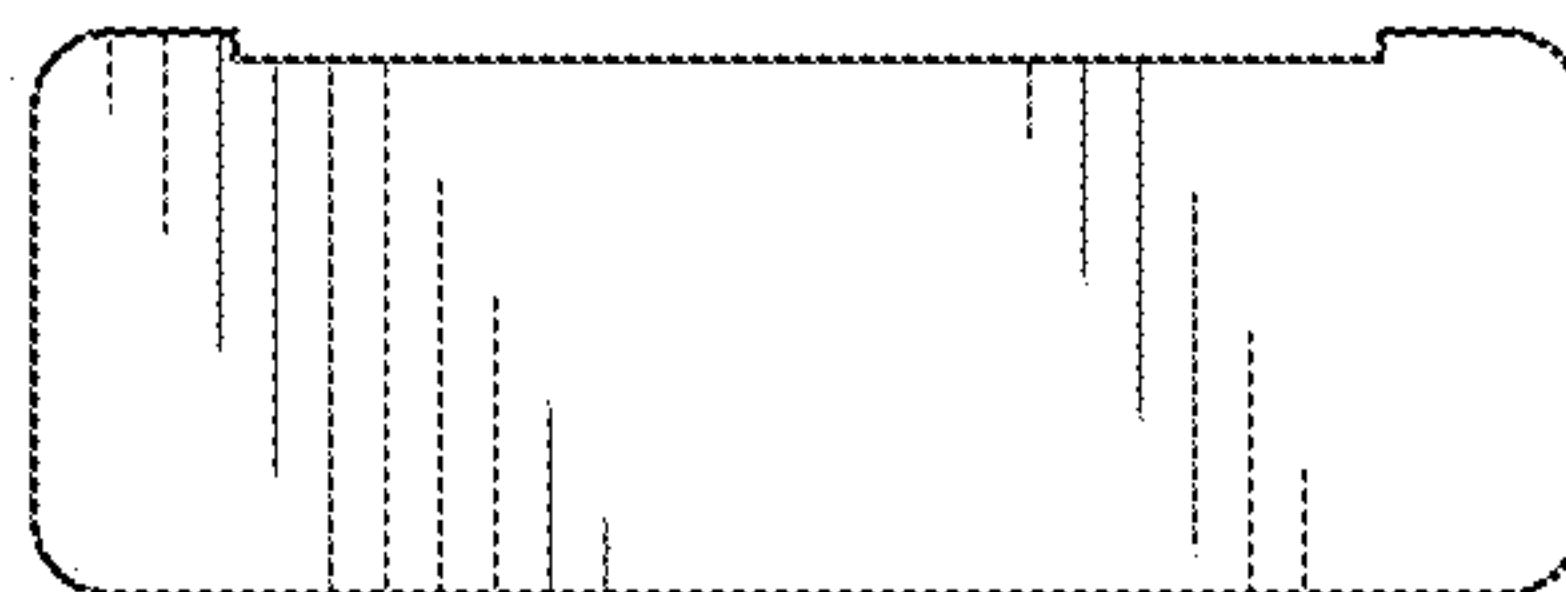

FIG. 3

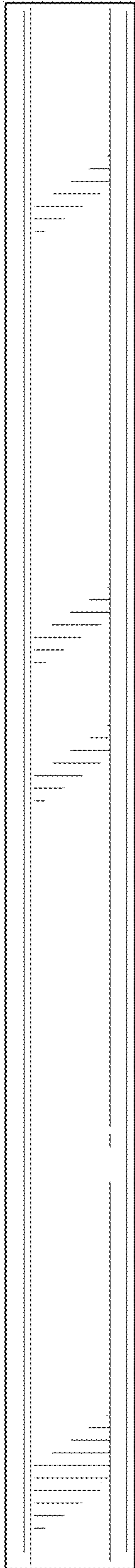

FIG. 4

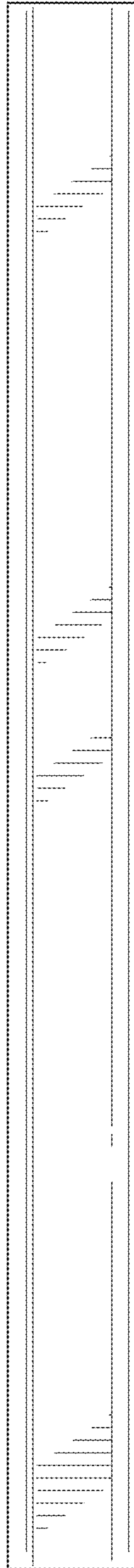

FIG. 5

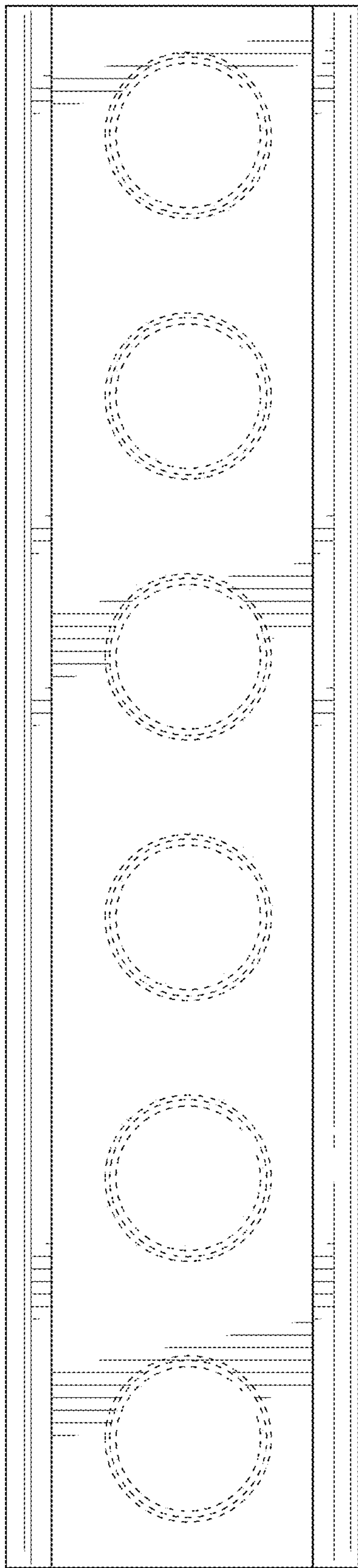

FIG. 6

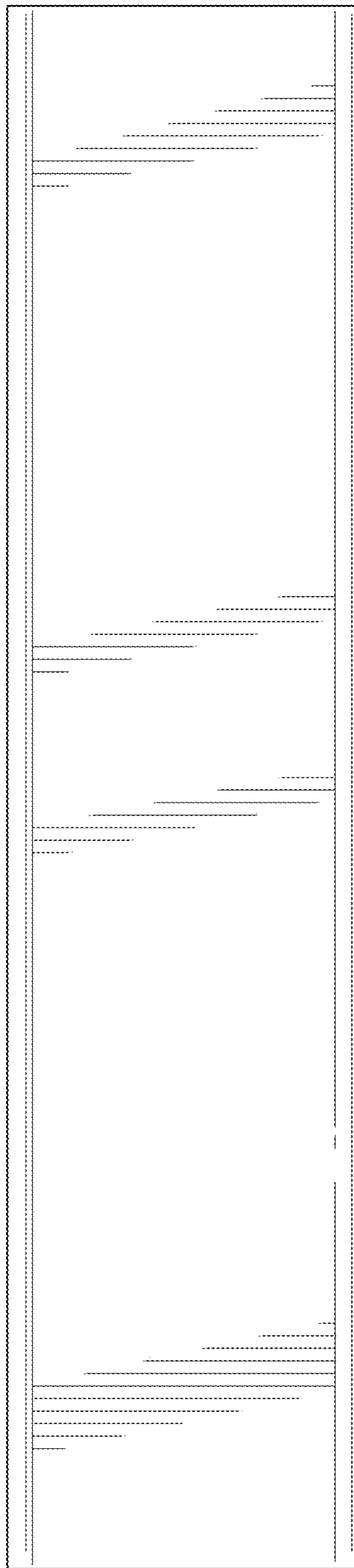

FIG. 7

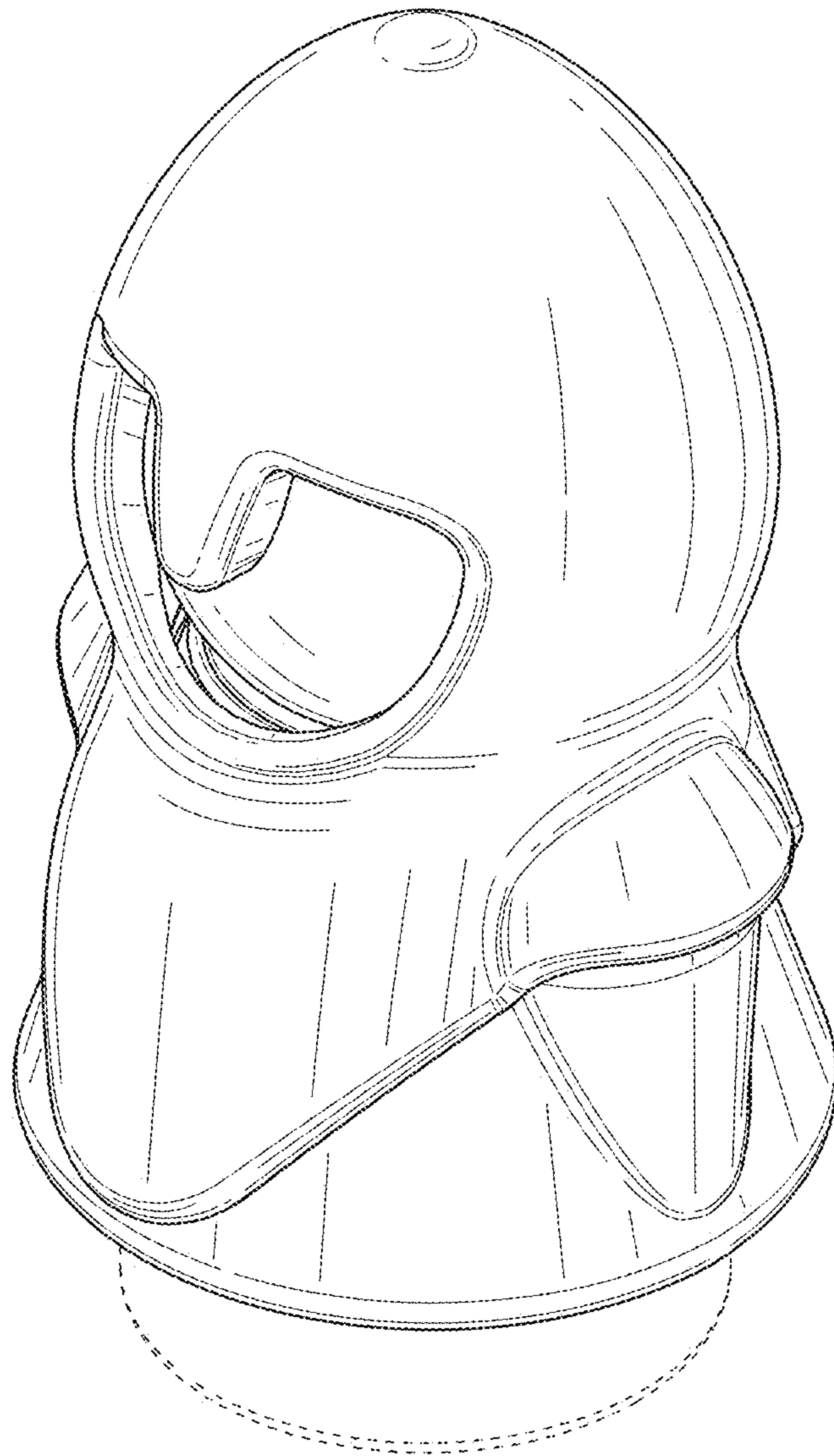

FIG. 8

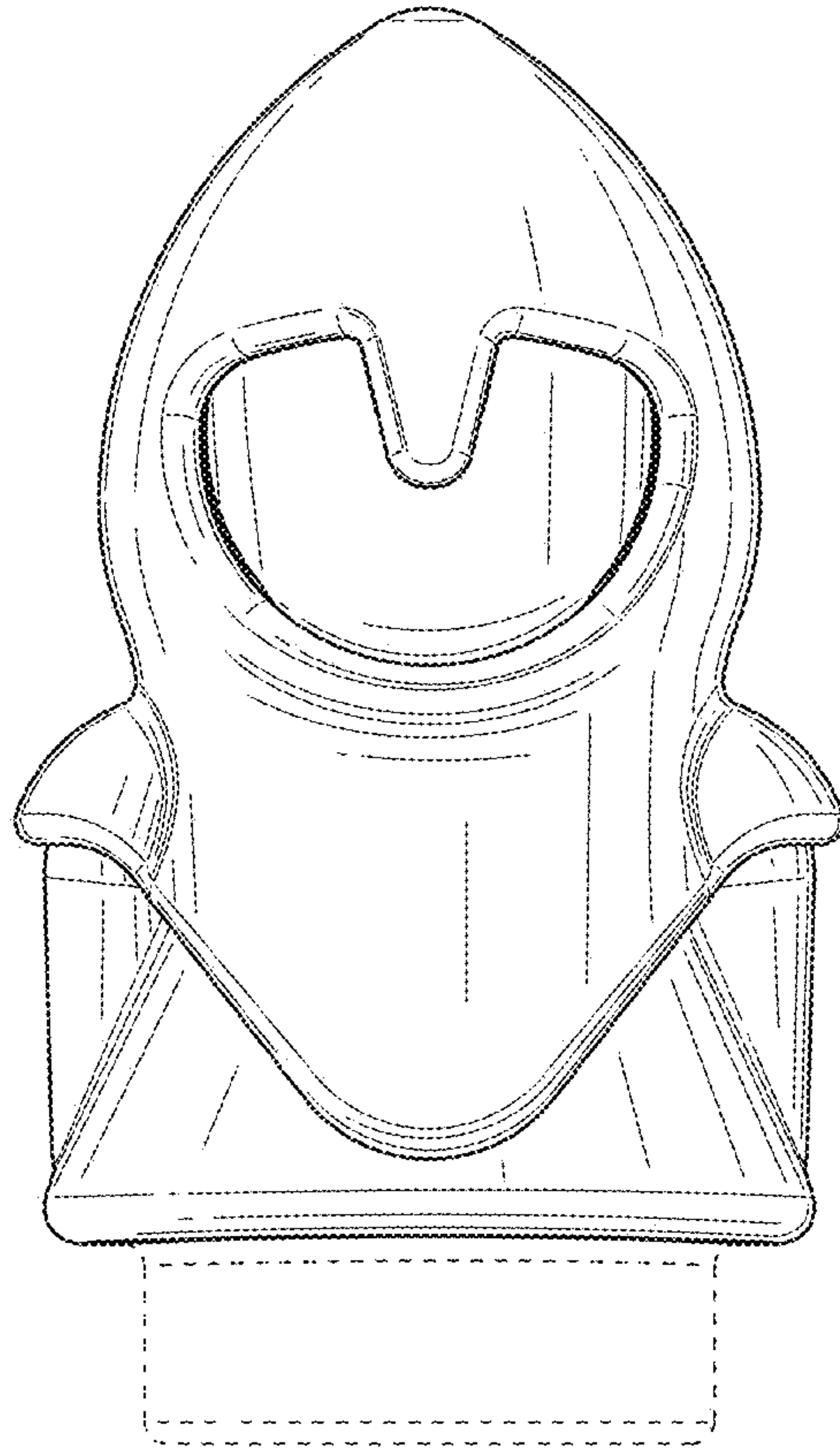

FIG. 9

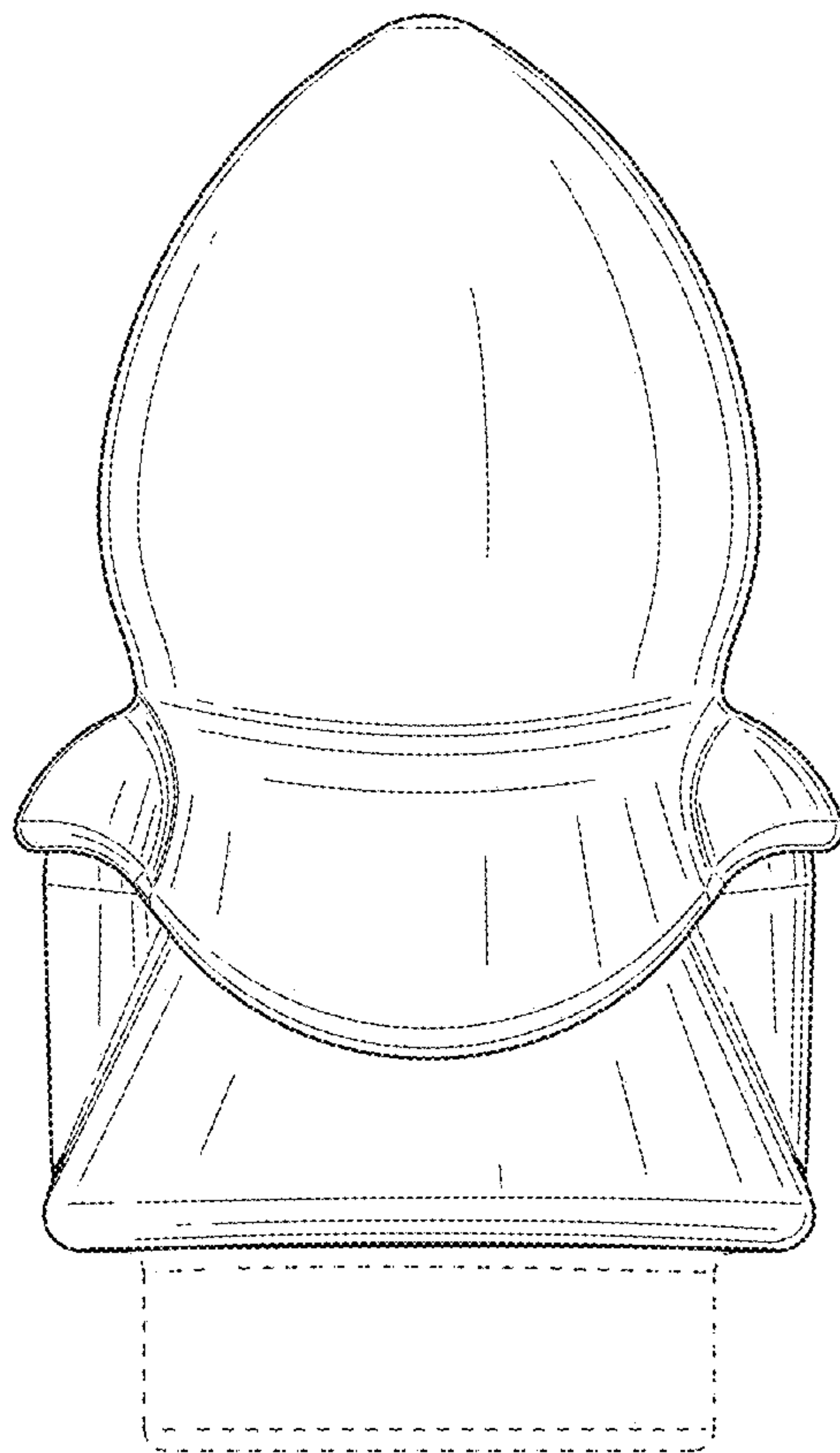

FIG. 10

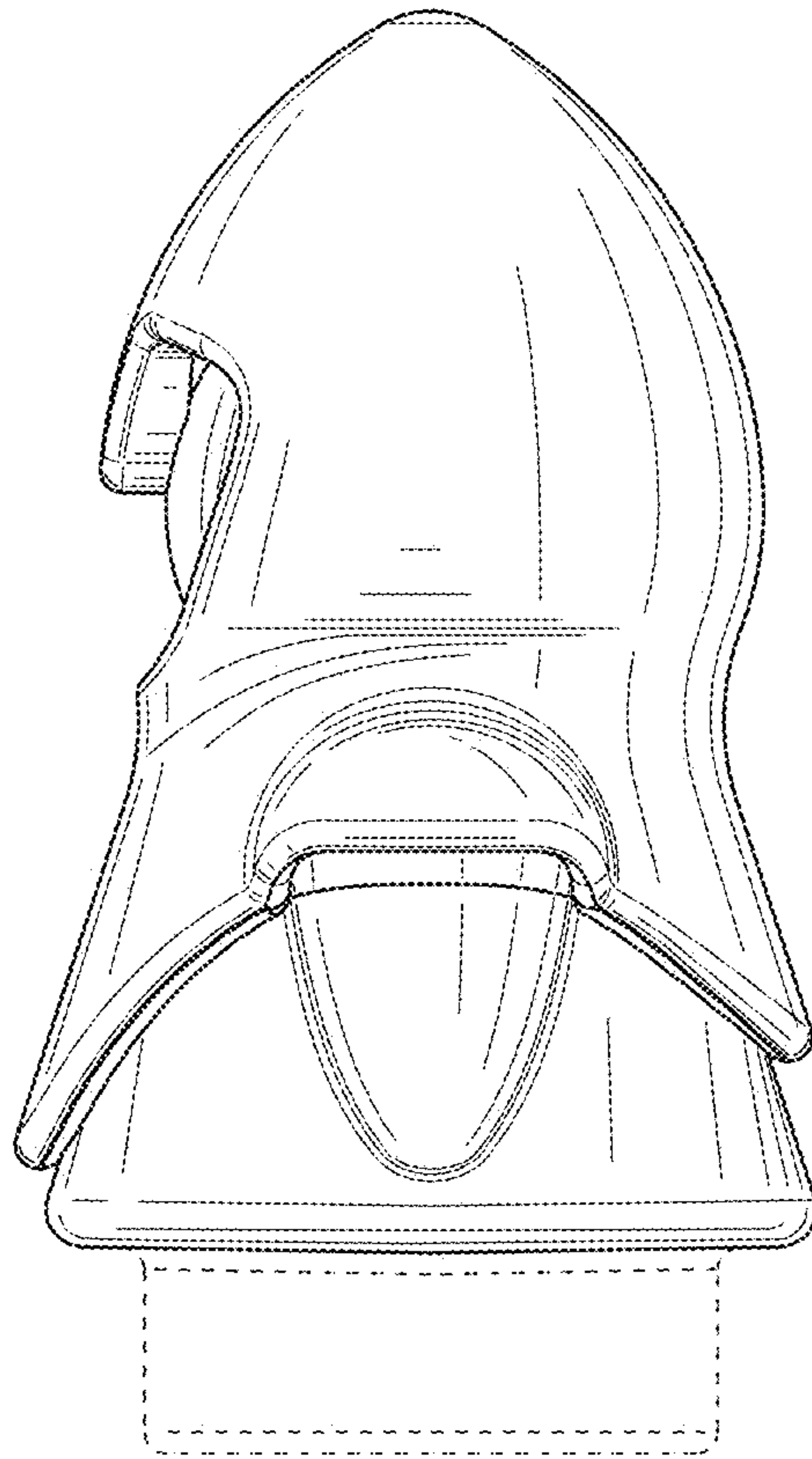

FIG. 11

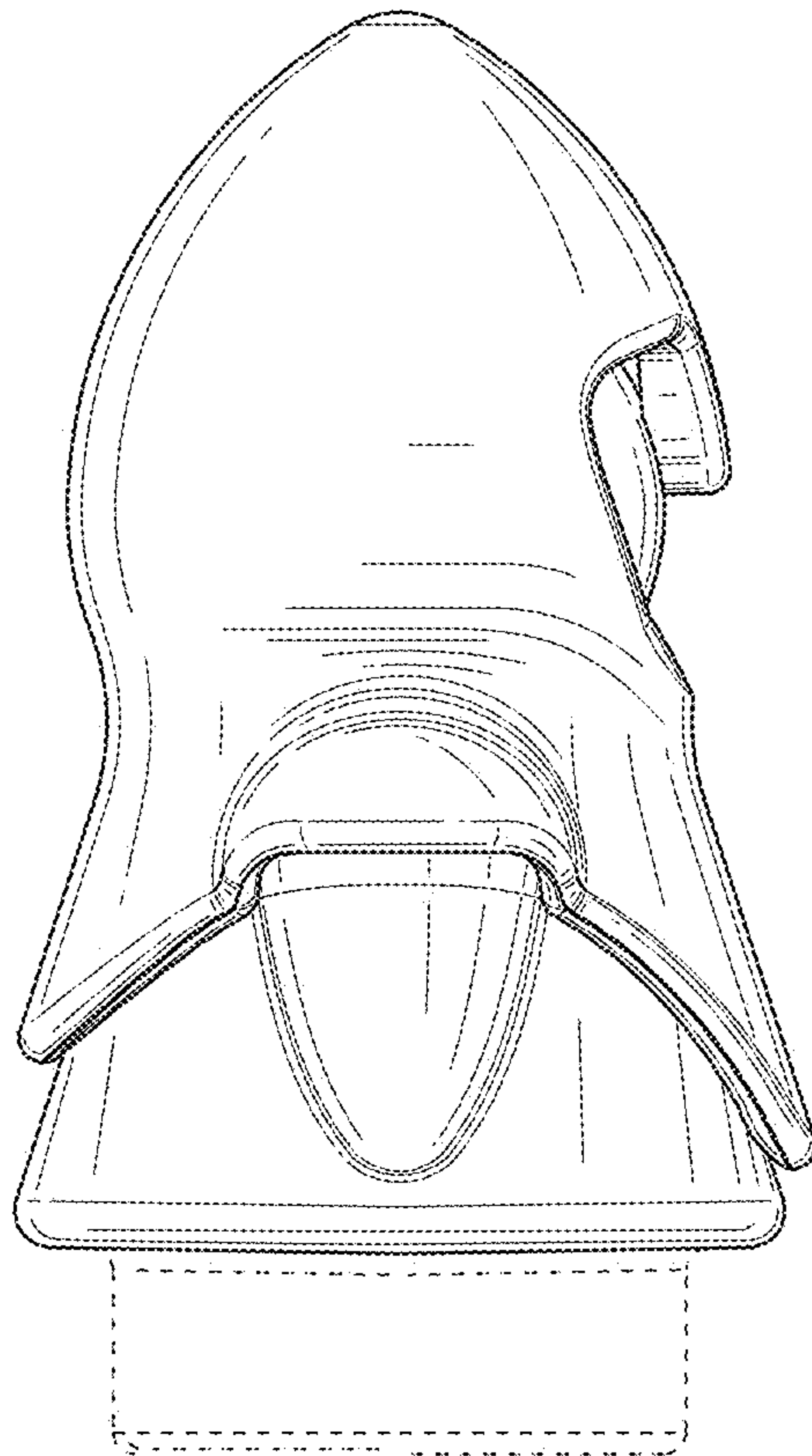

FIG. 12

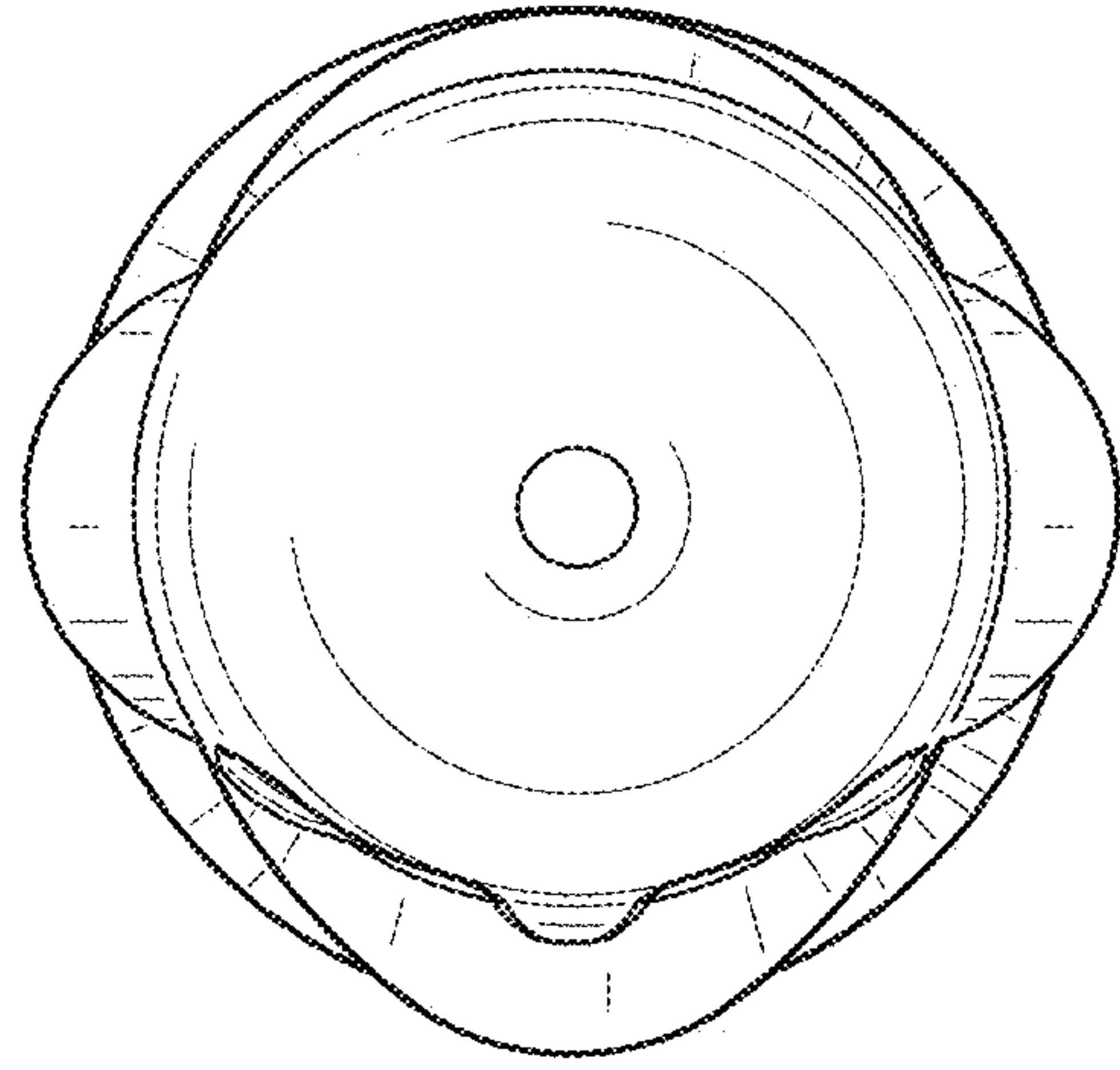

FIG. 13

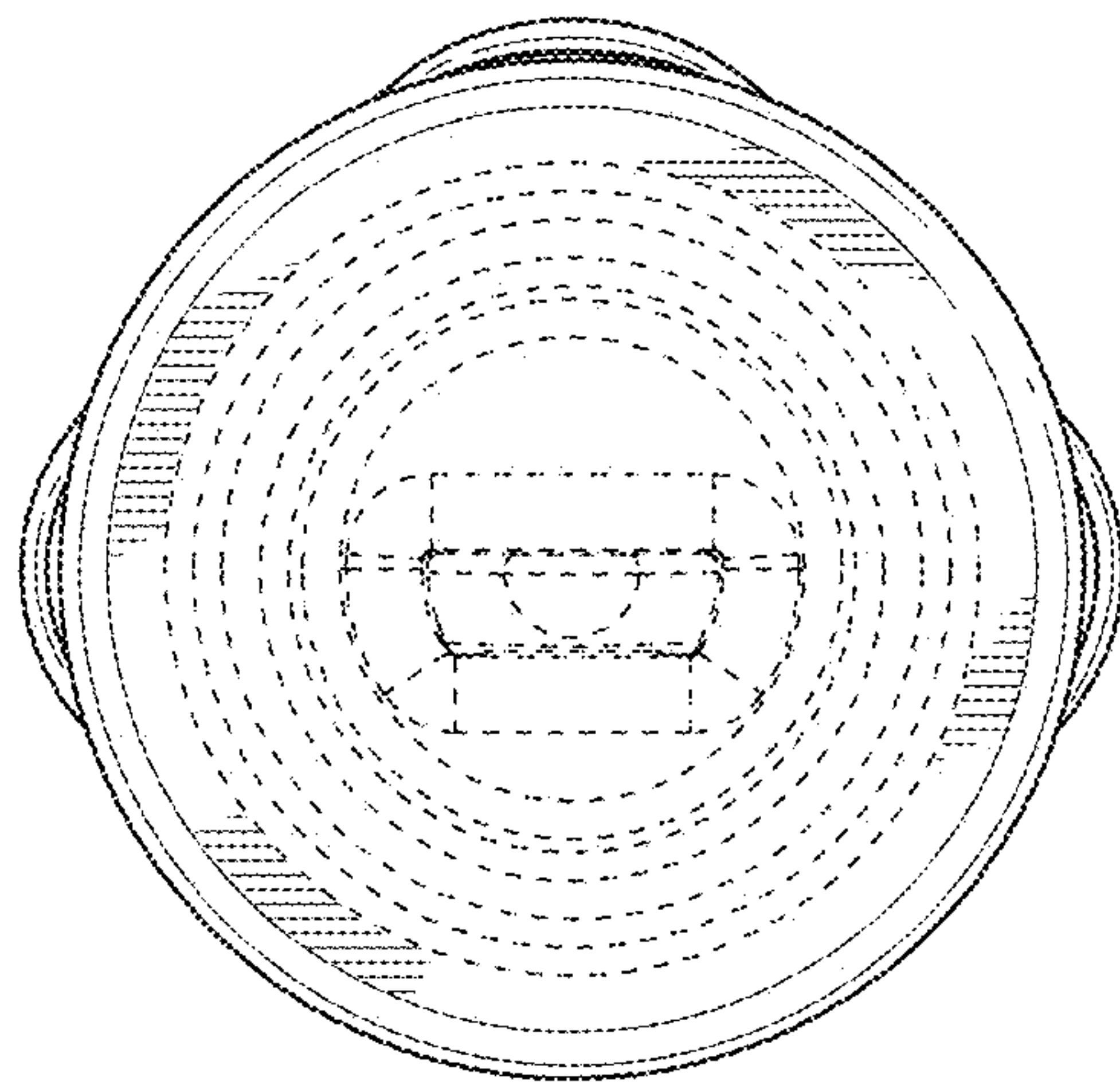

FIG. 14

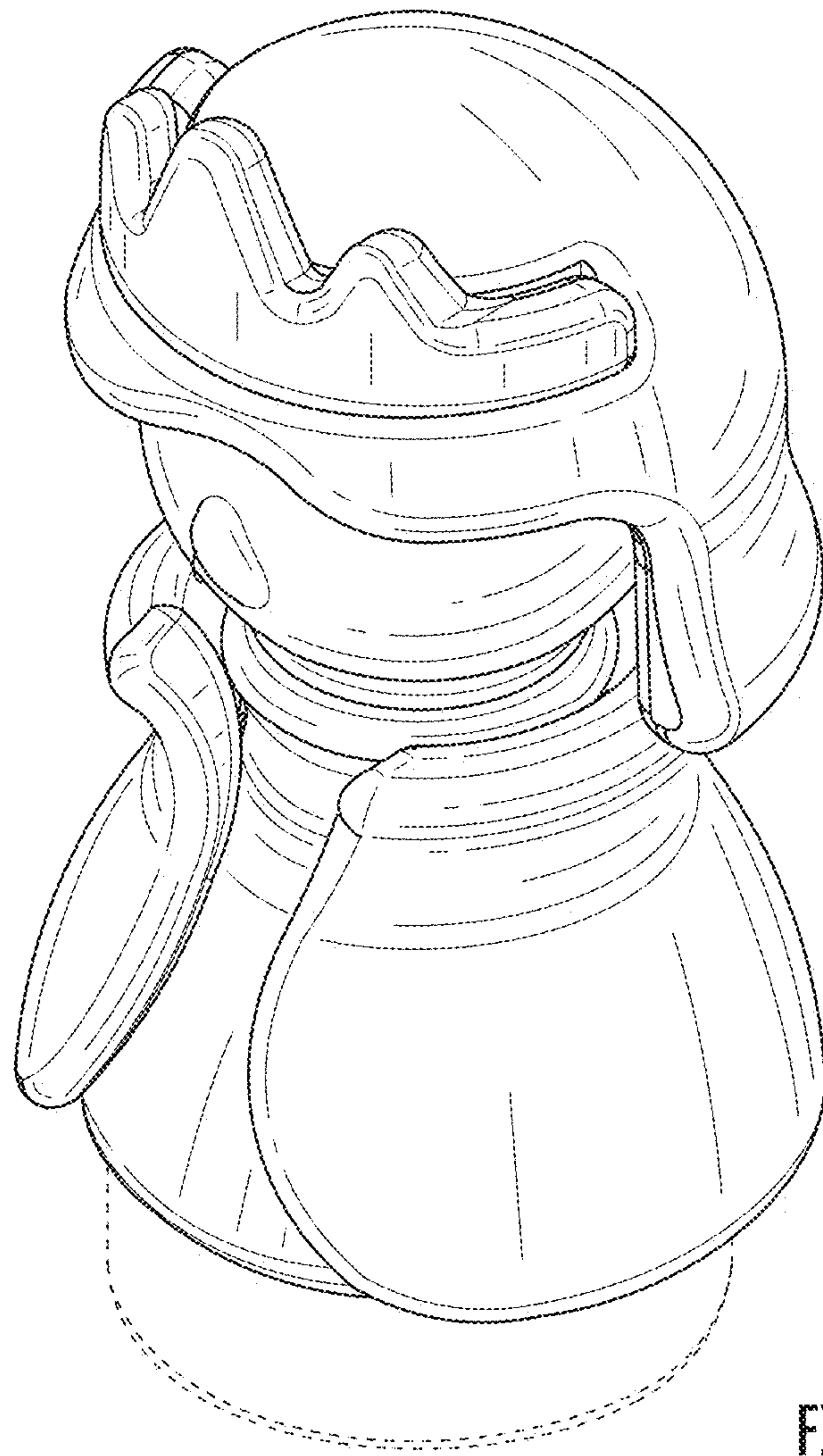

FIG. 15

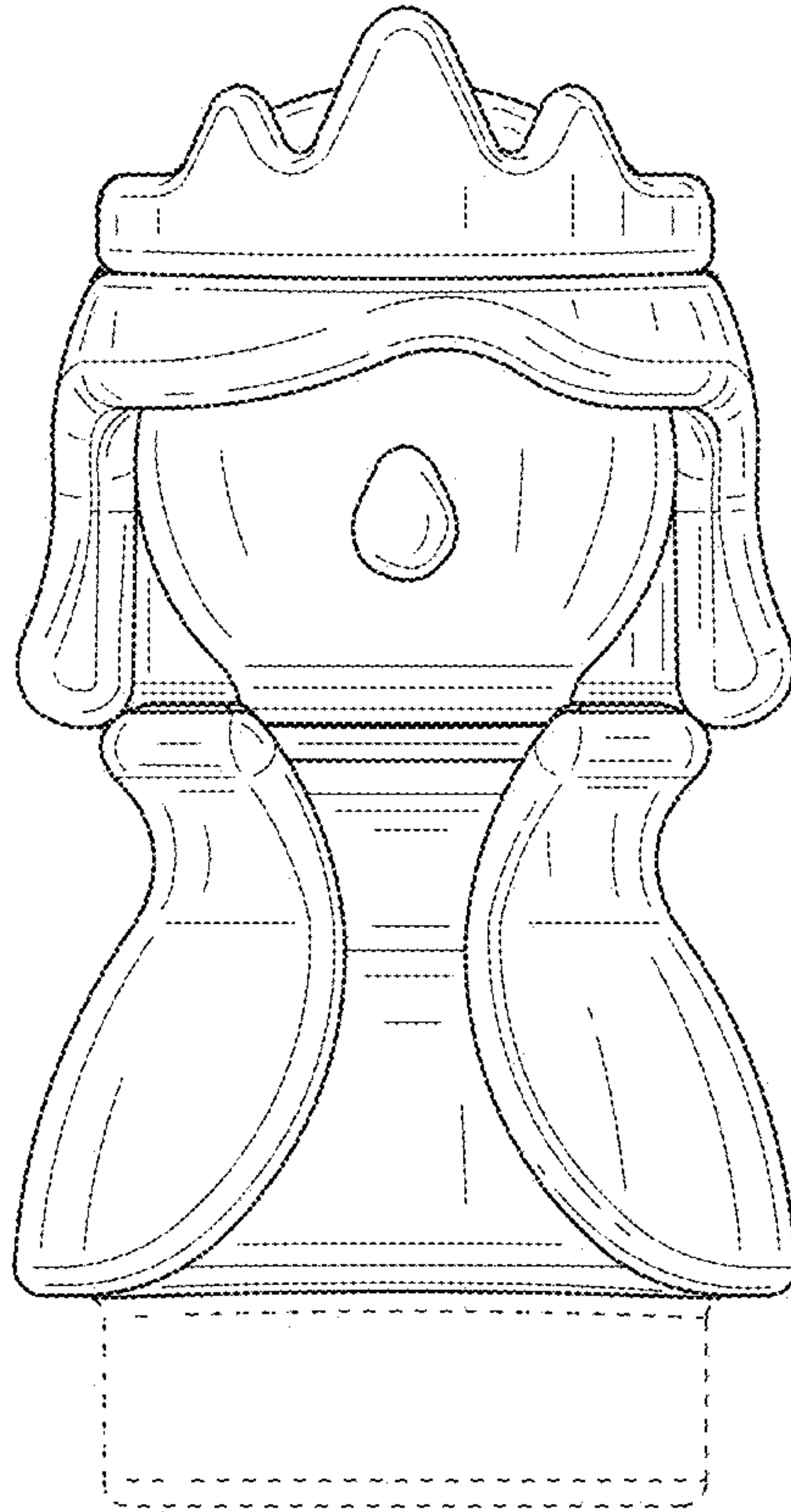

FIG. 16

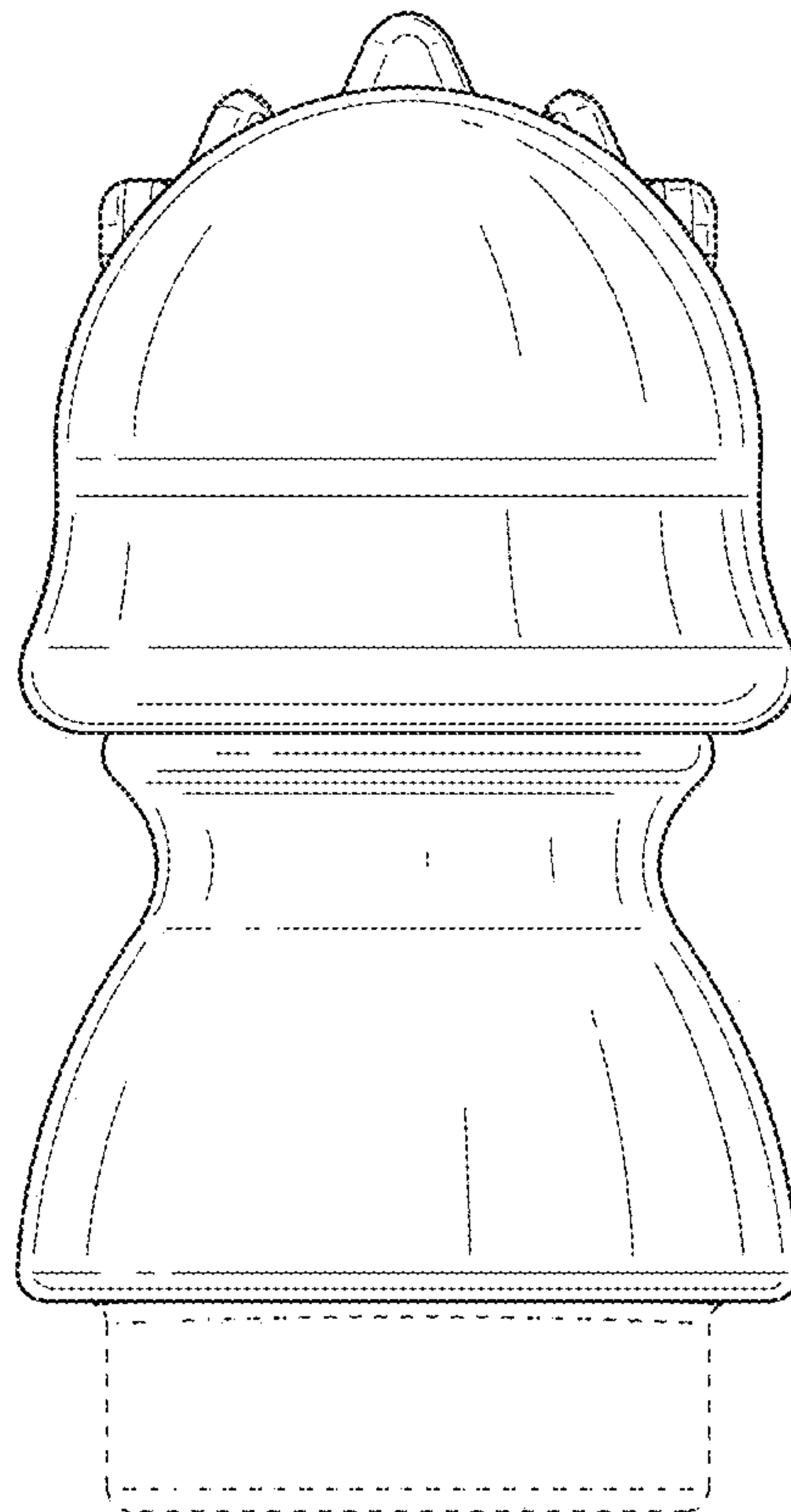

FIG. 17

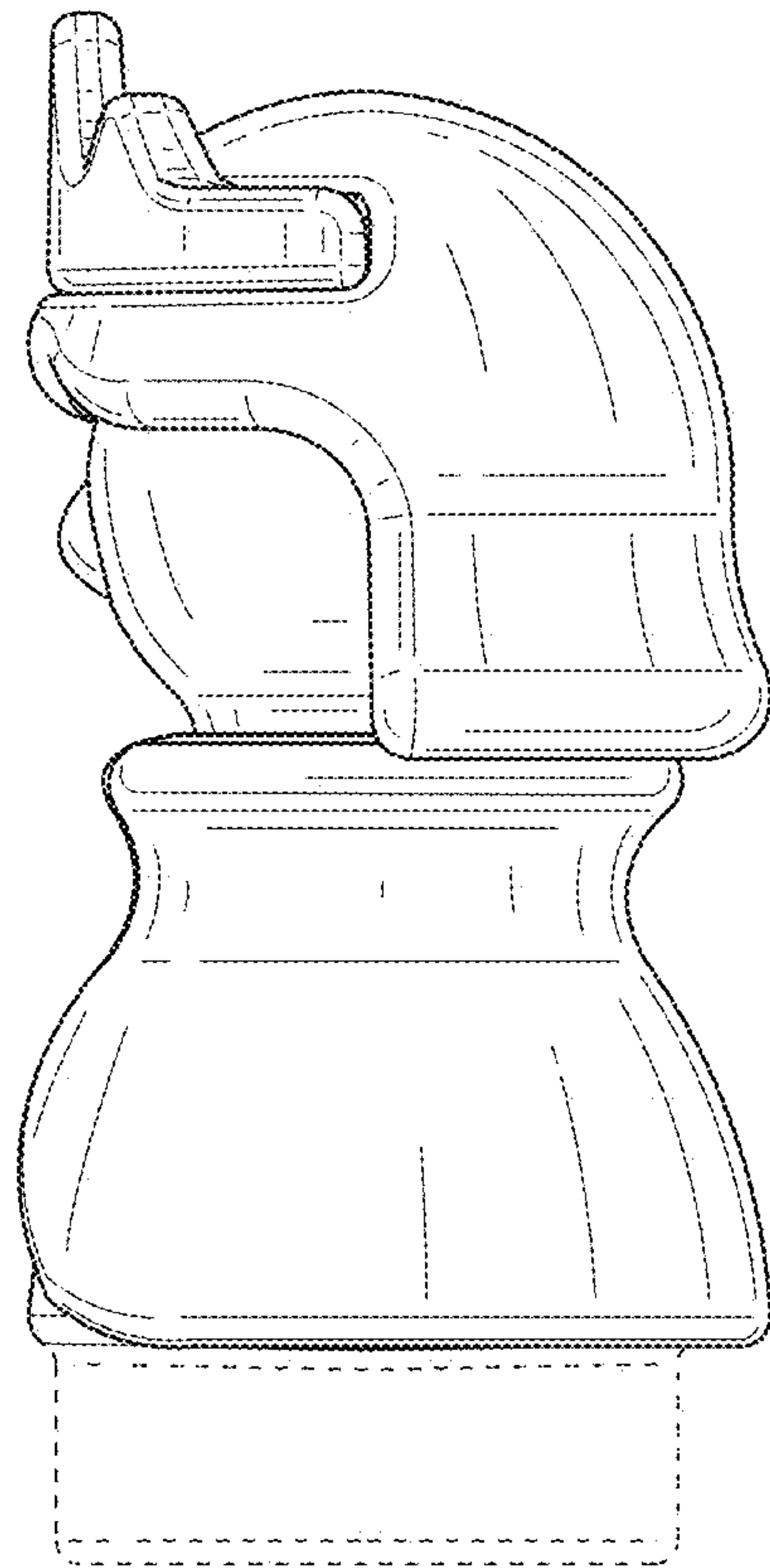

FIG. 18

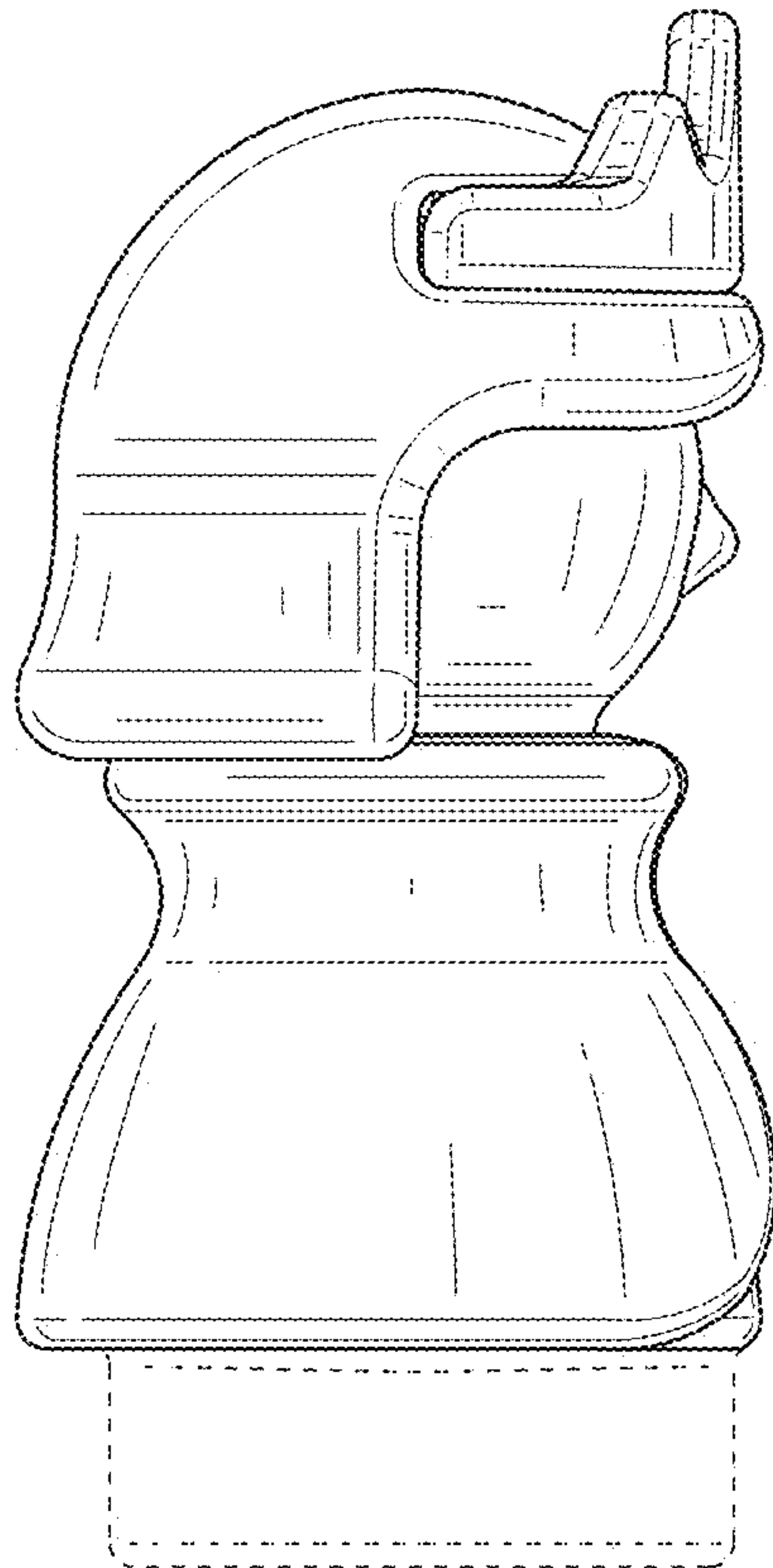

FIG. 19

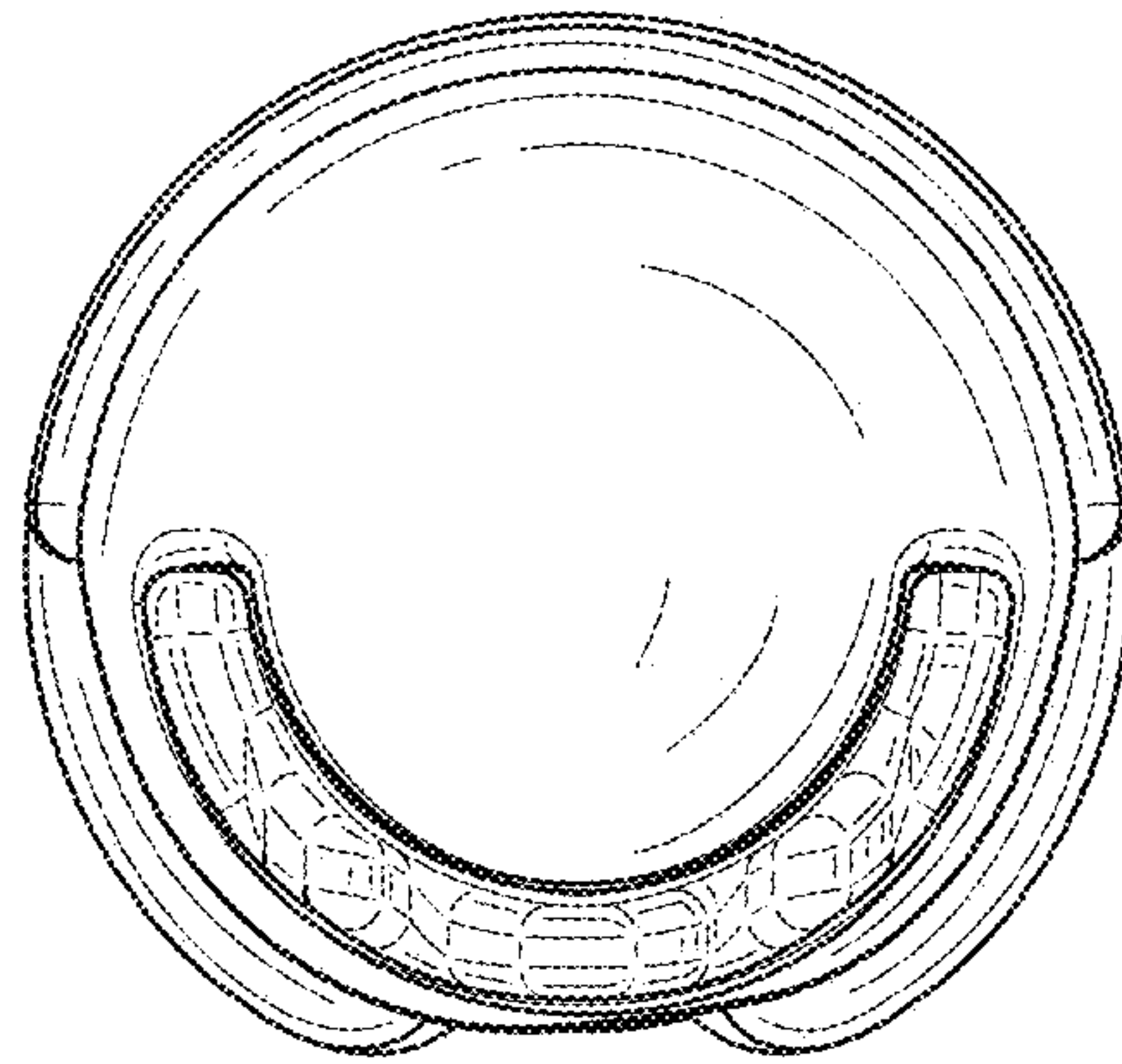

FIG. 20

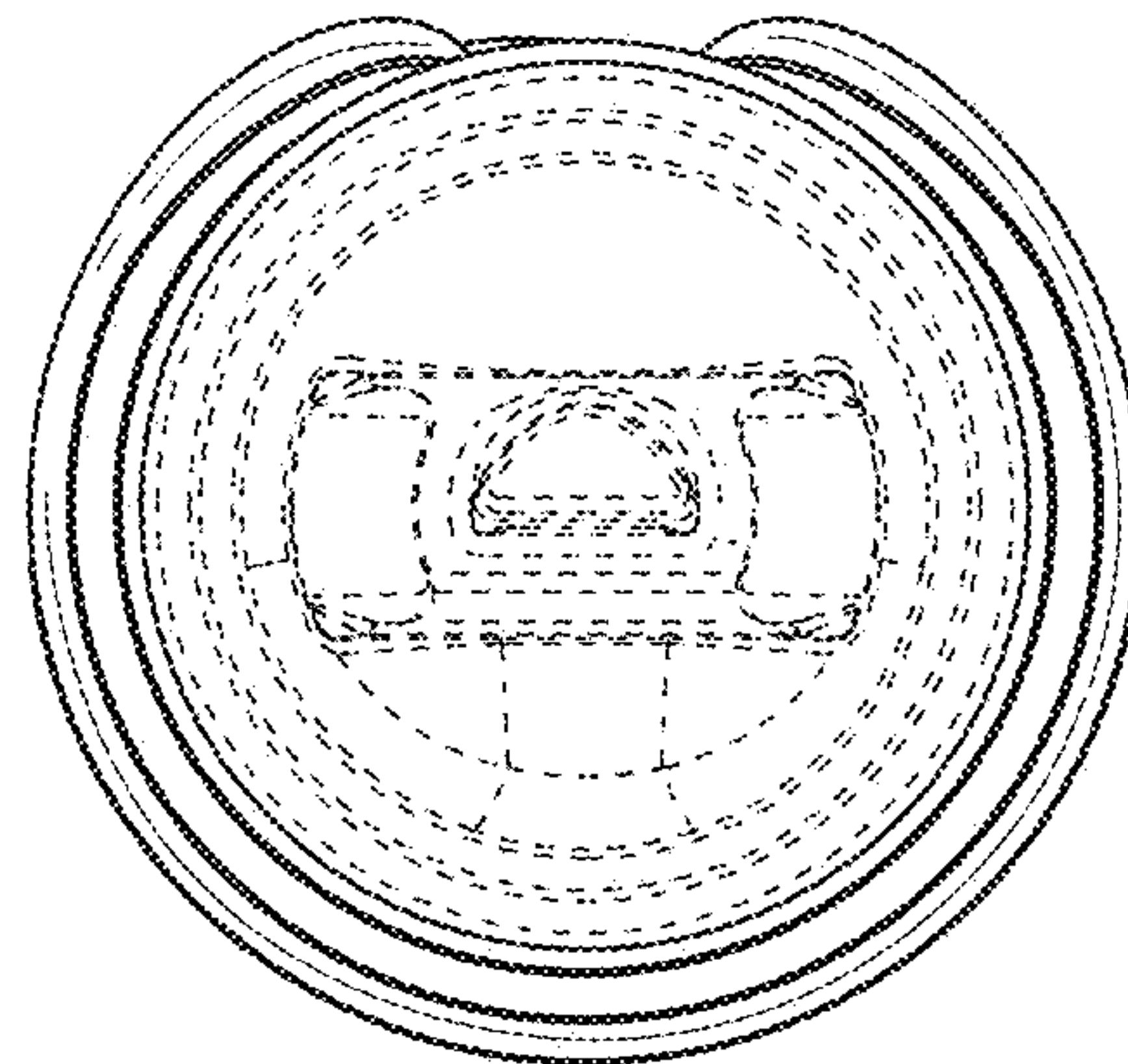

FIG. 21

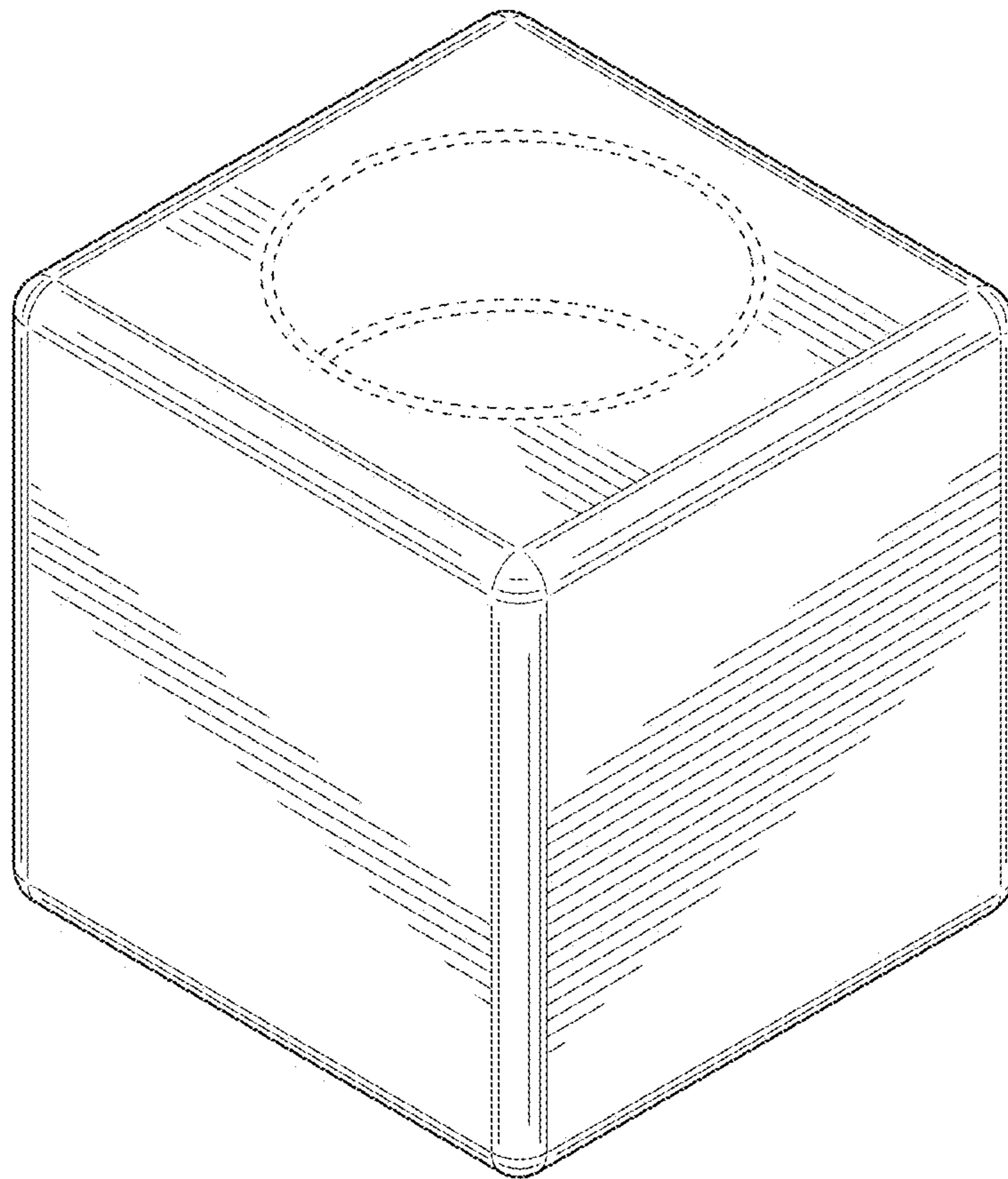

FIG. 22

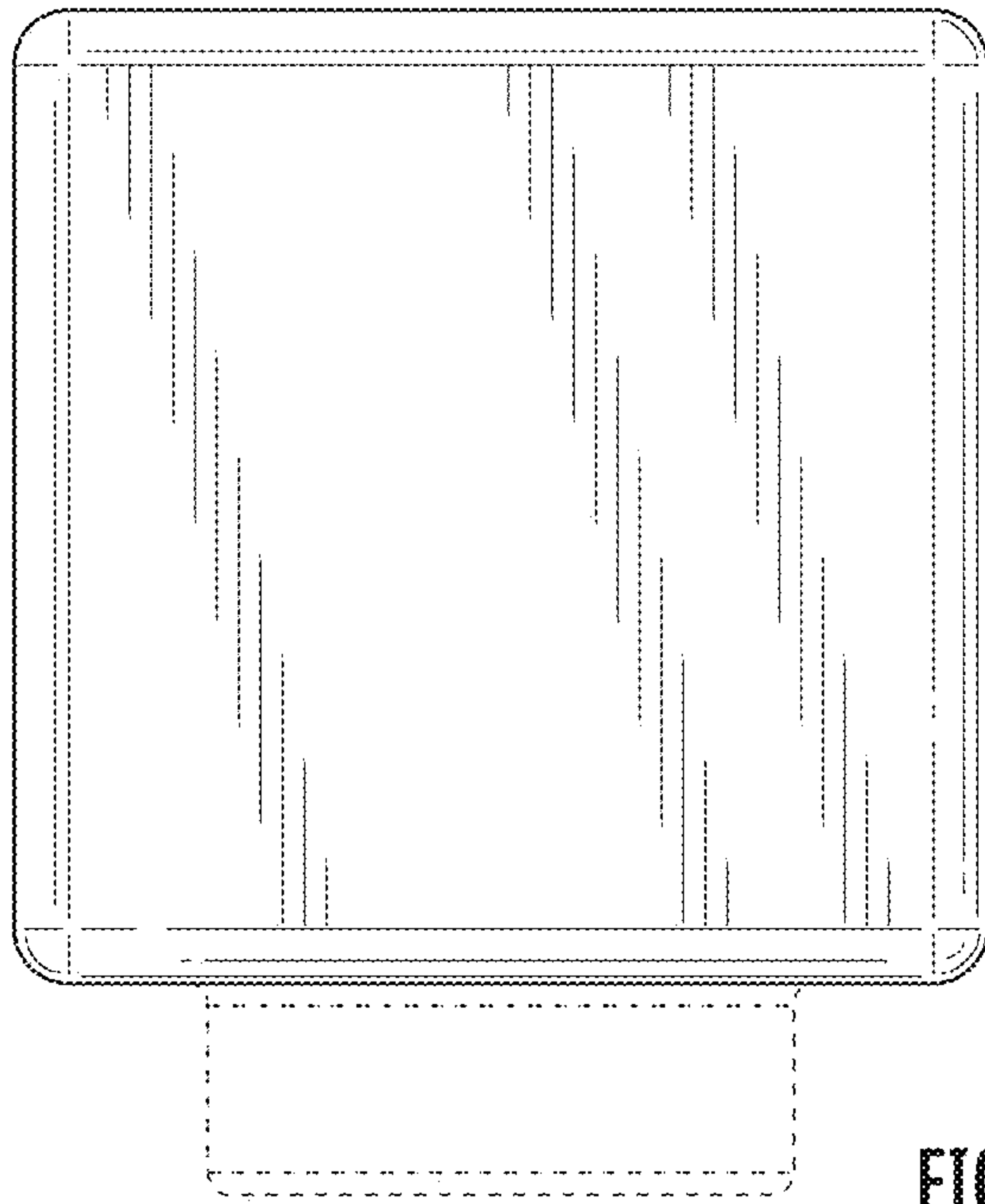

FIG. 23

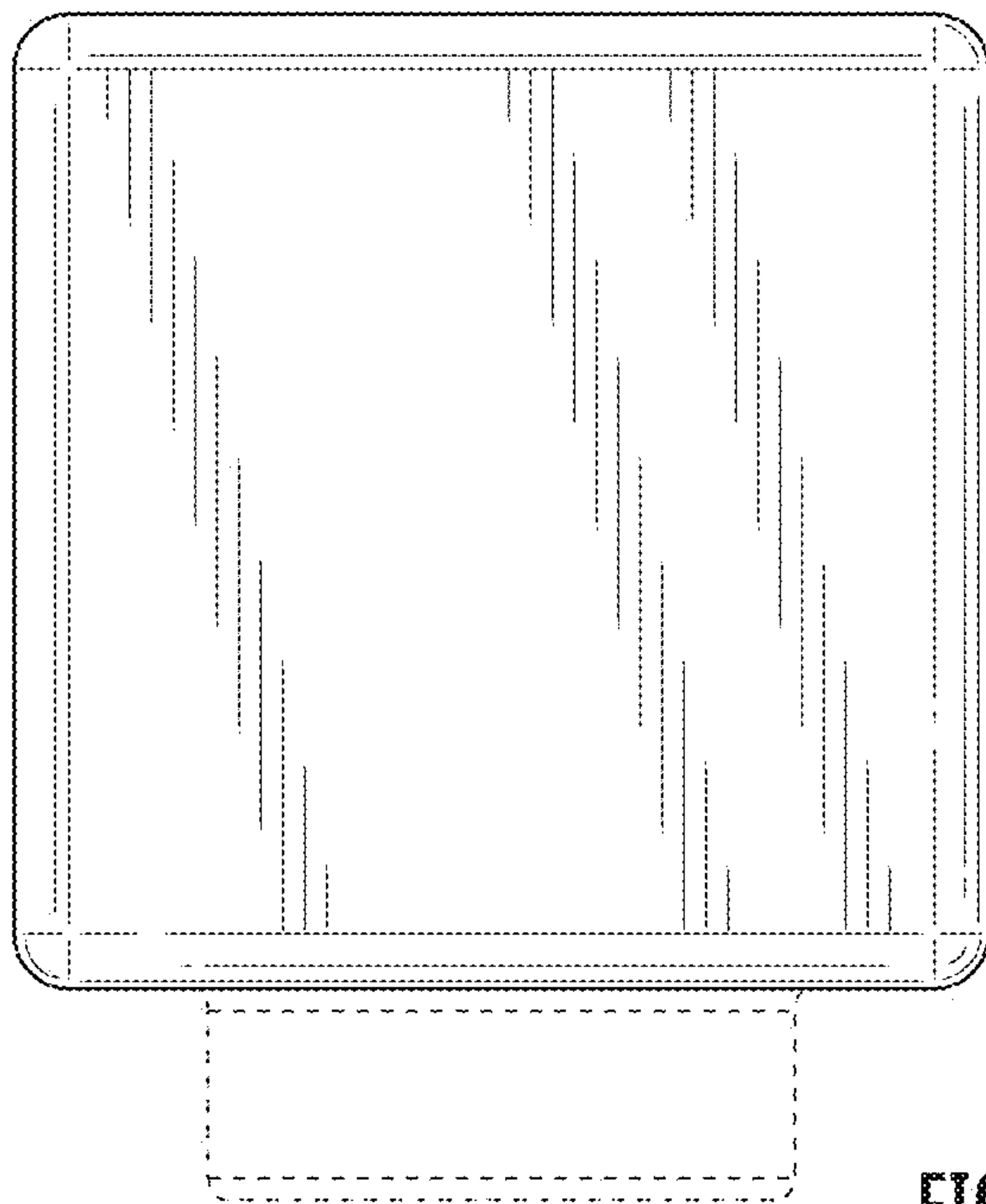

FIG. 24

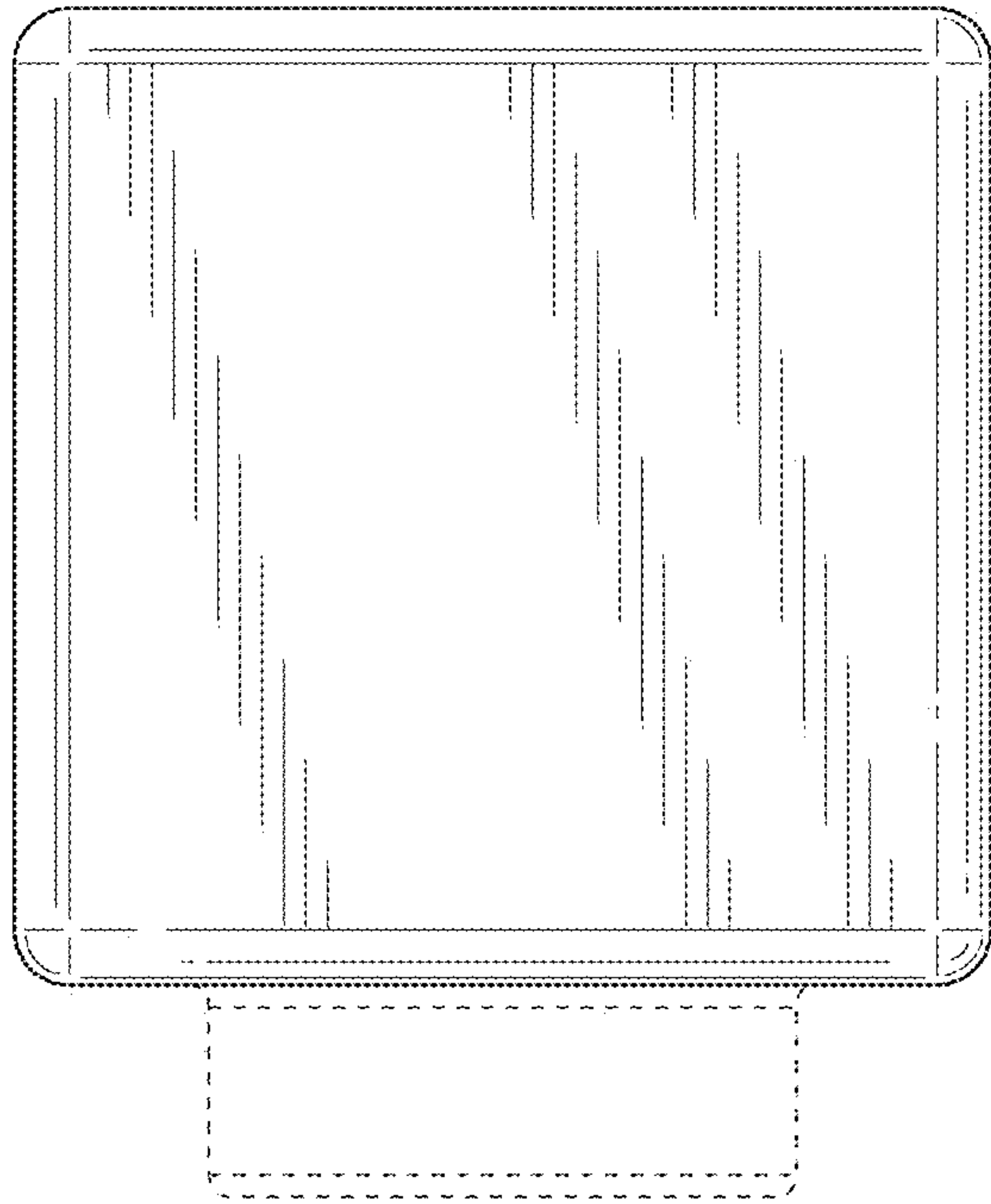

FIG. 25

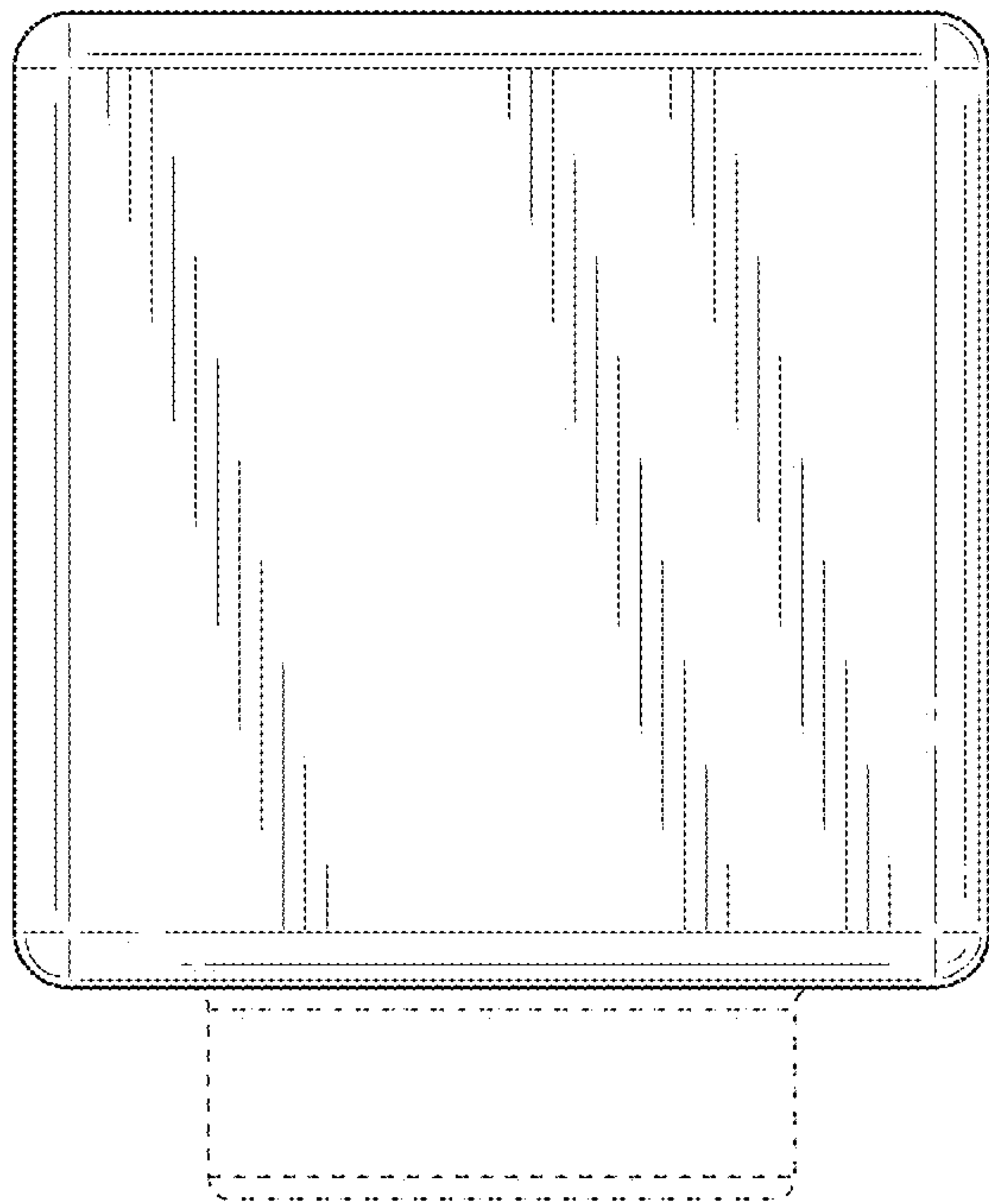

FIG. 26

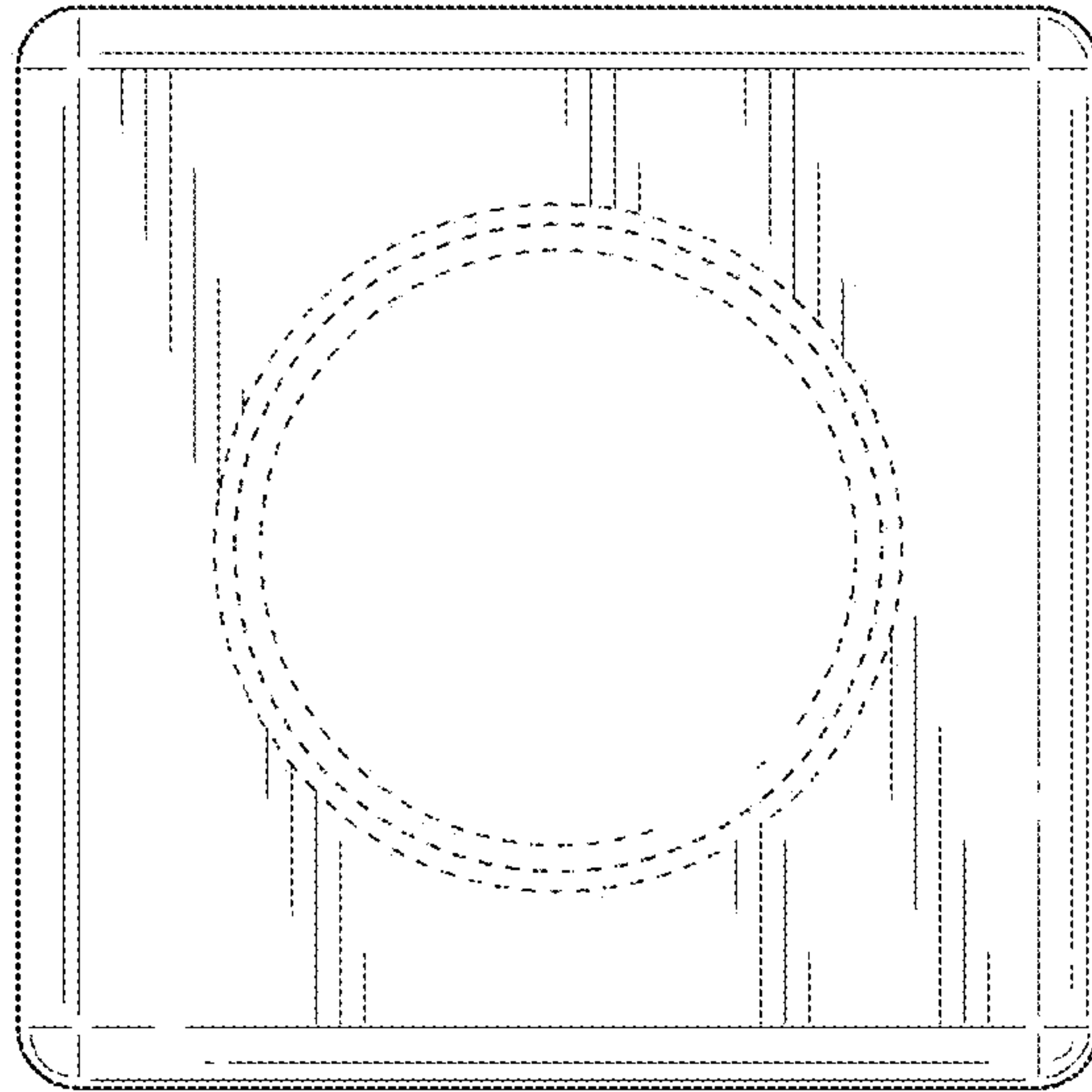

FIG. 27

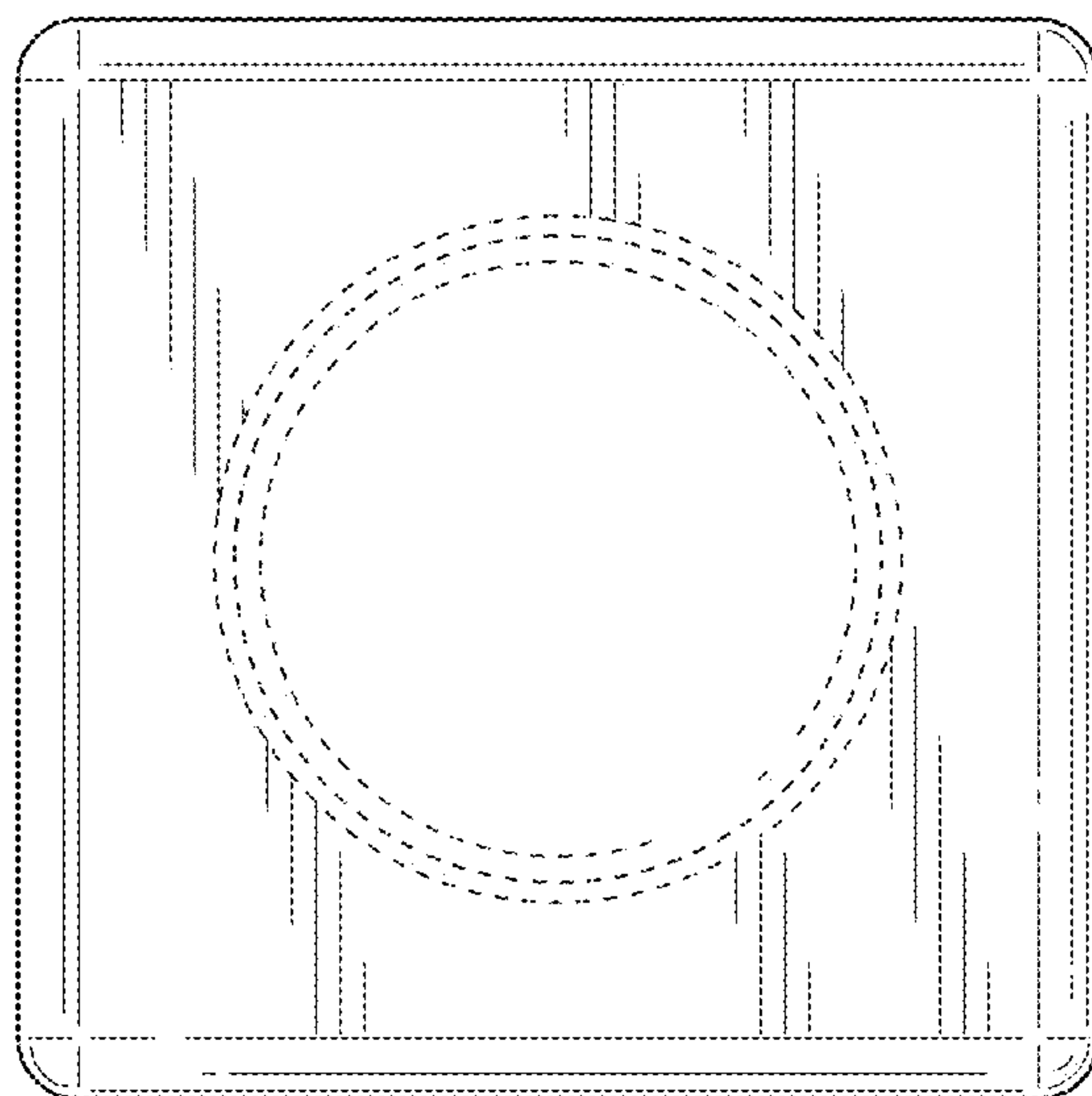

FIG. 28

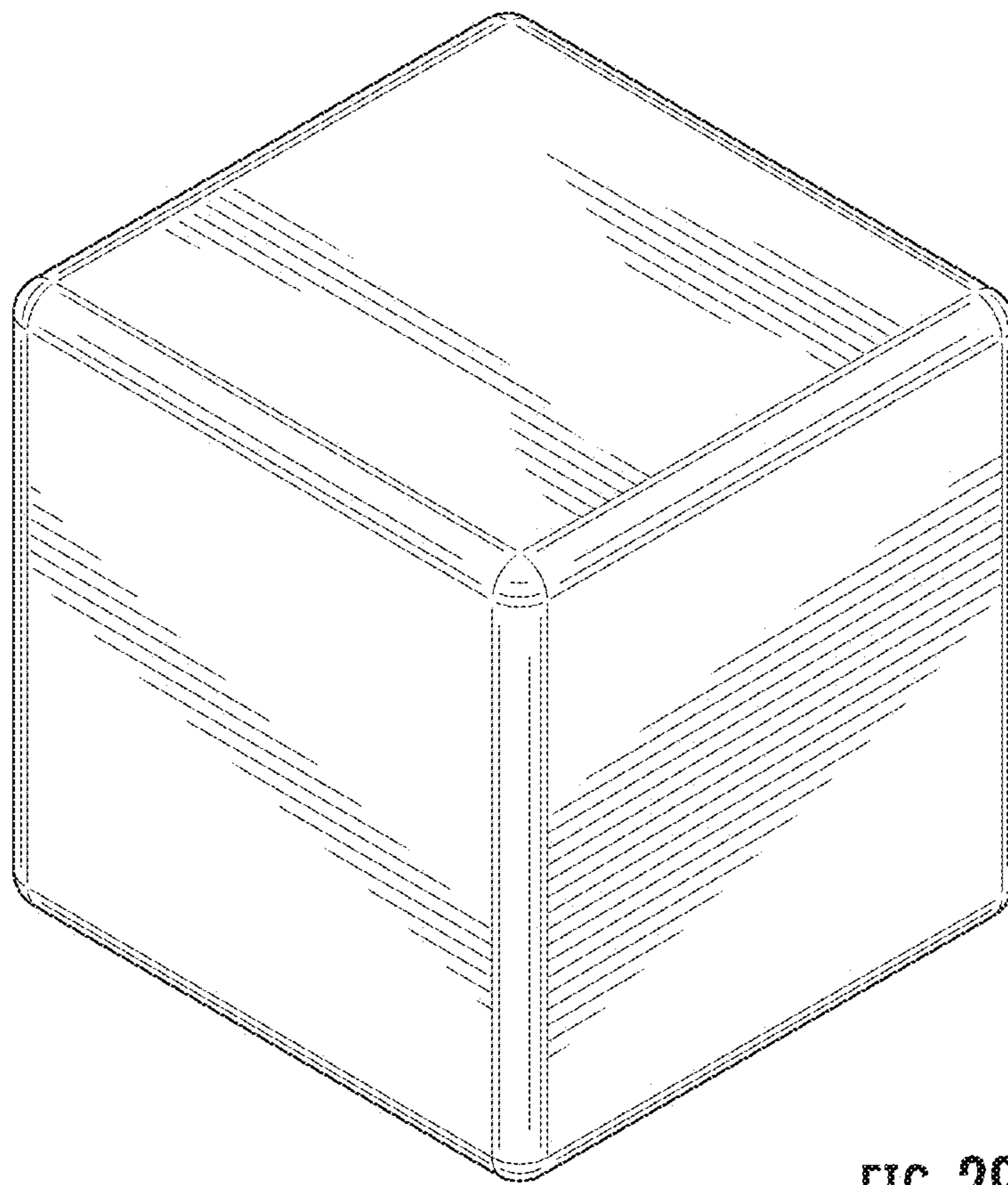

FIG. 29

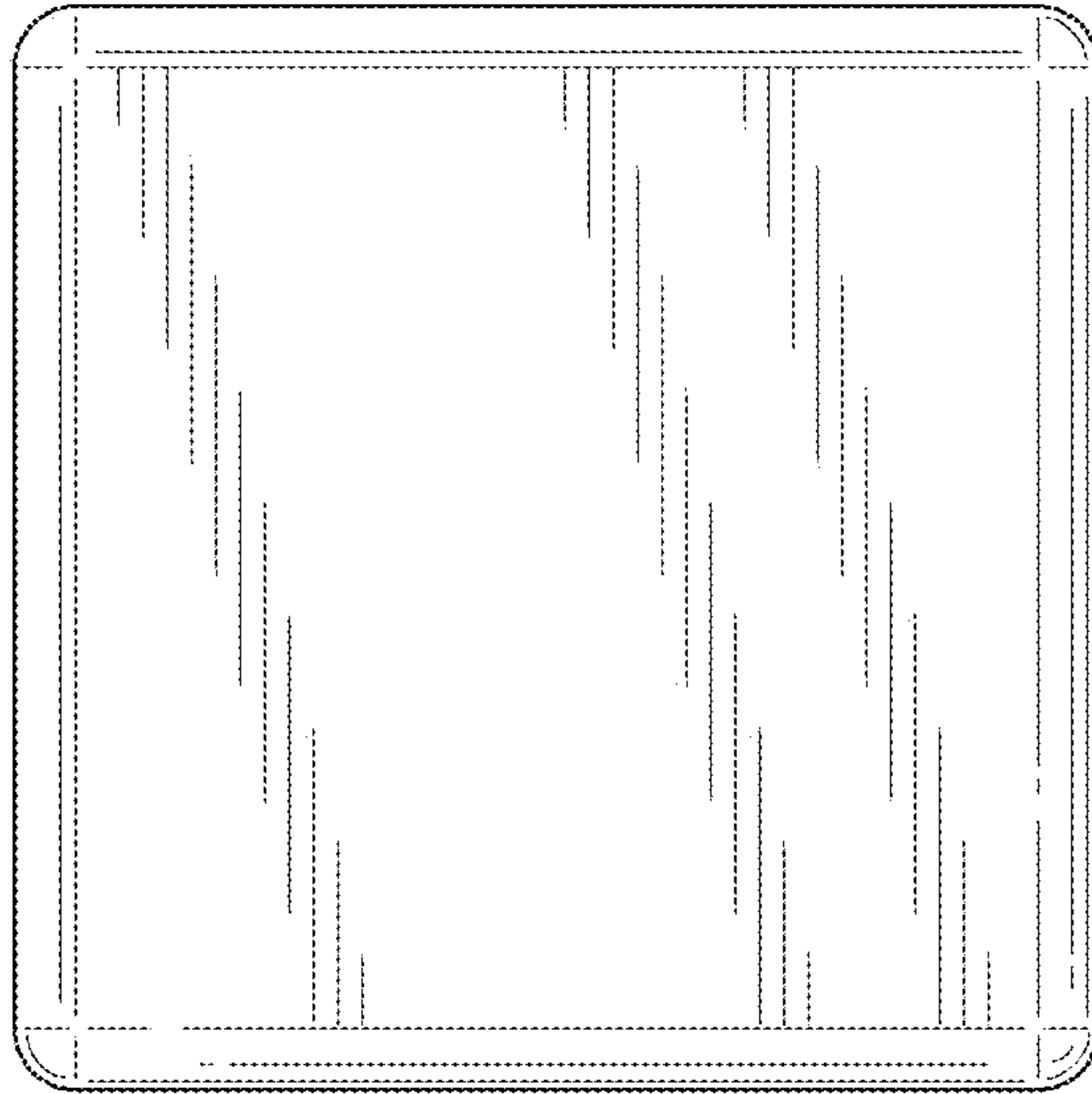

FIG. 30

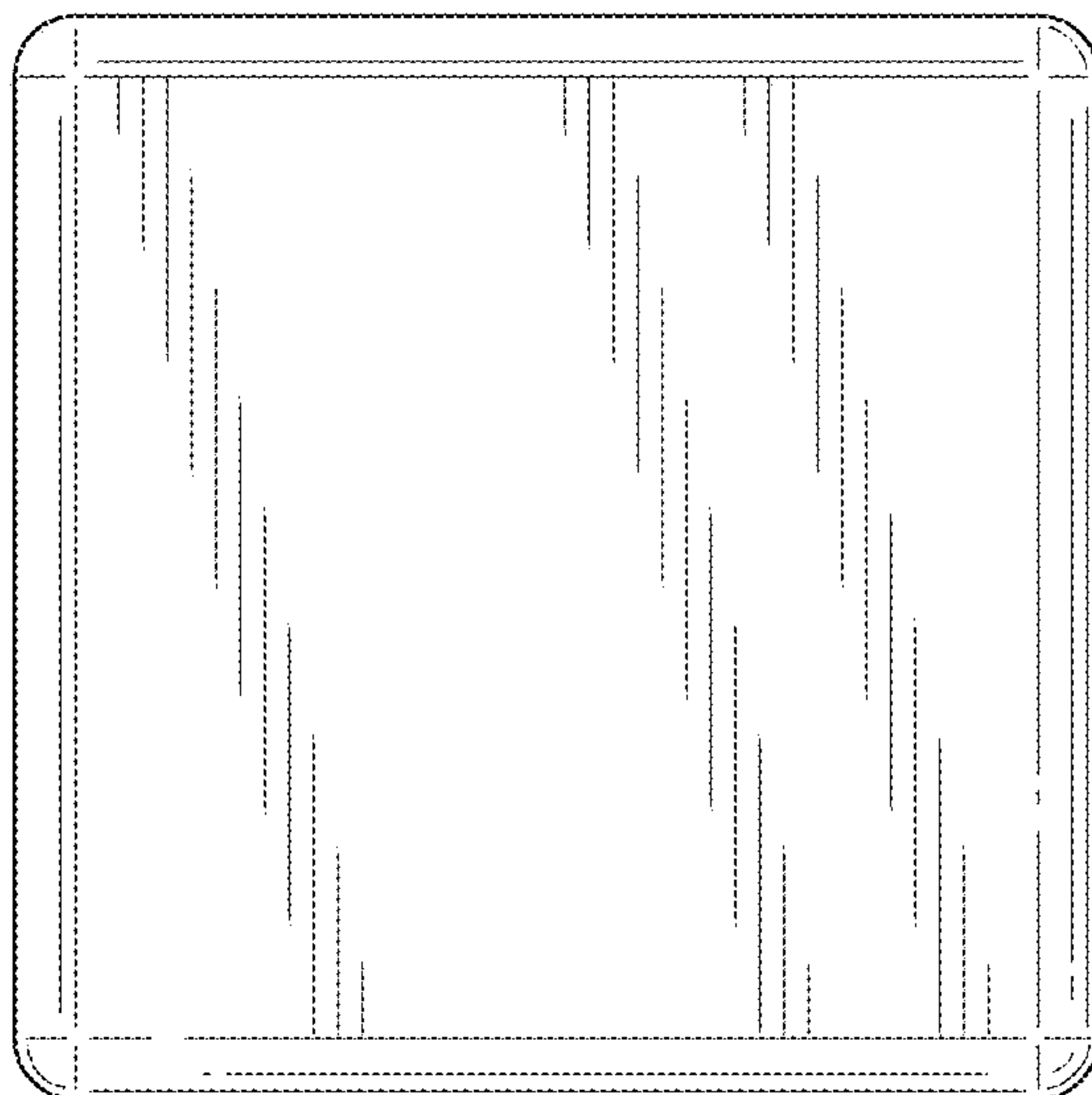

FIG. 31

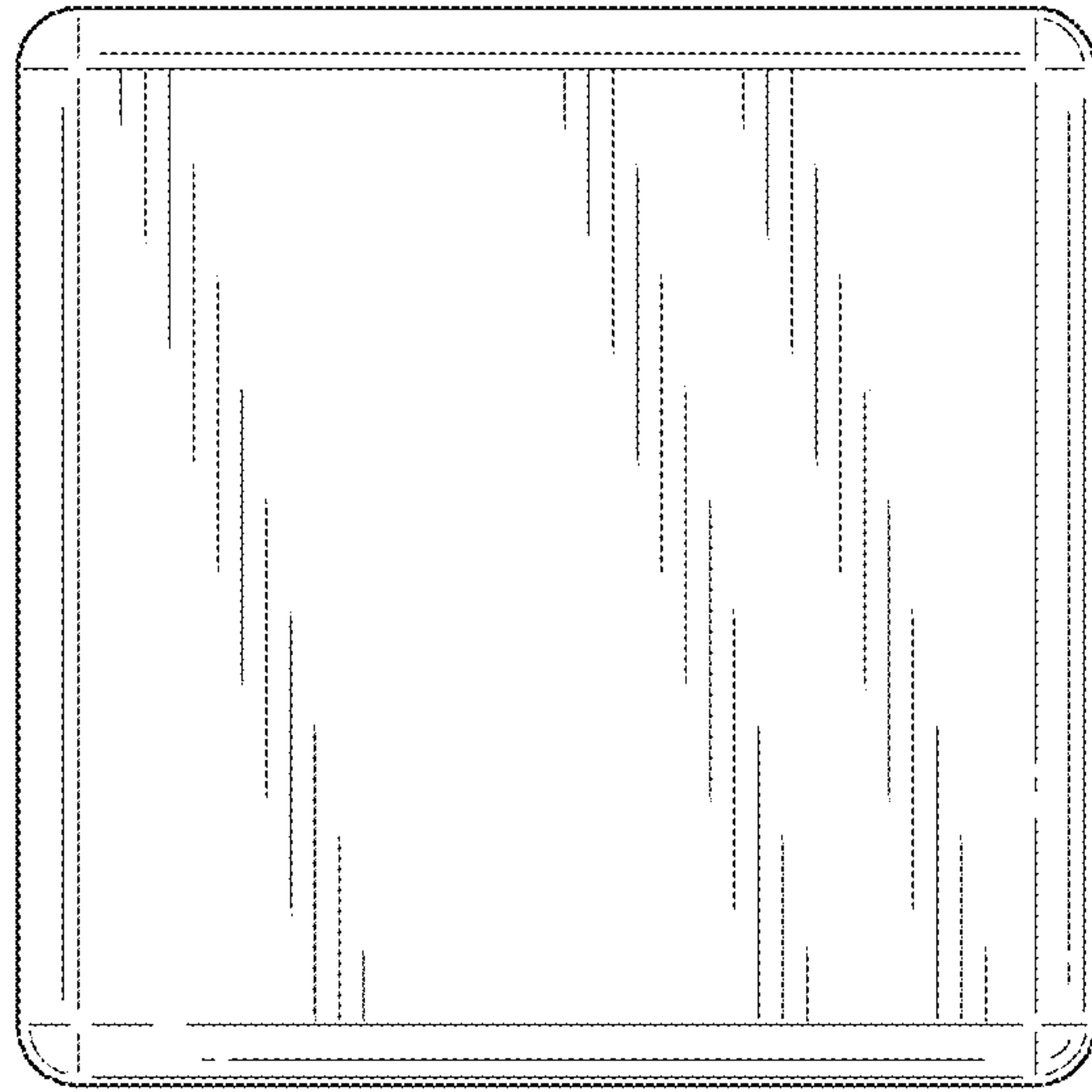

FIG. 32

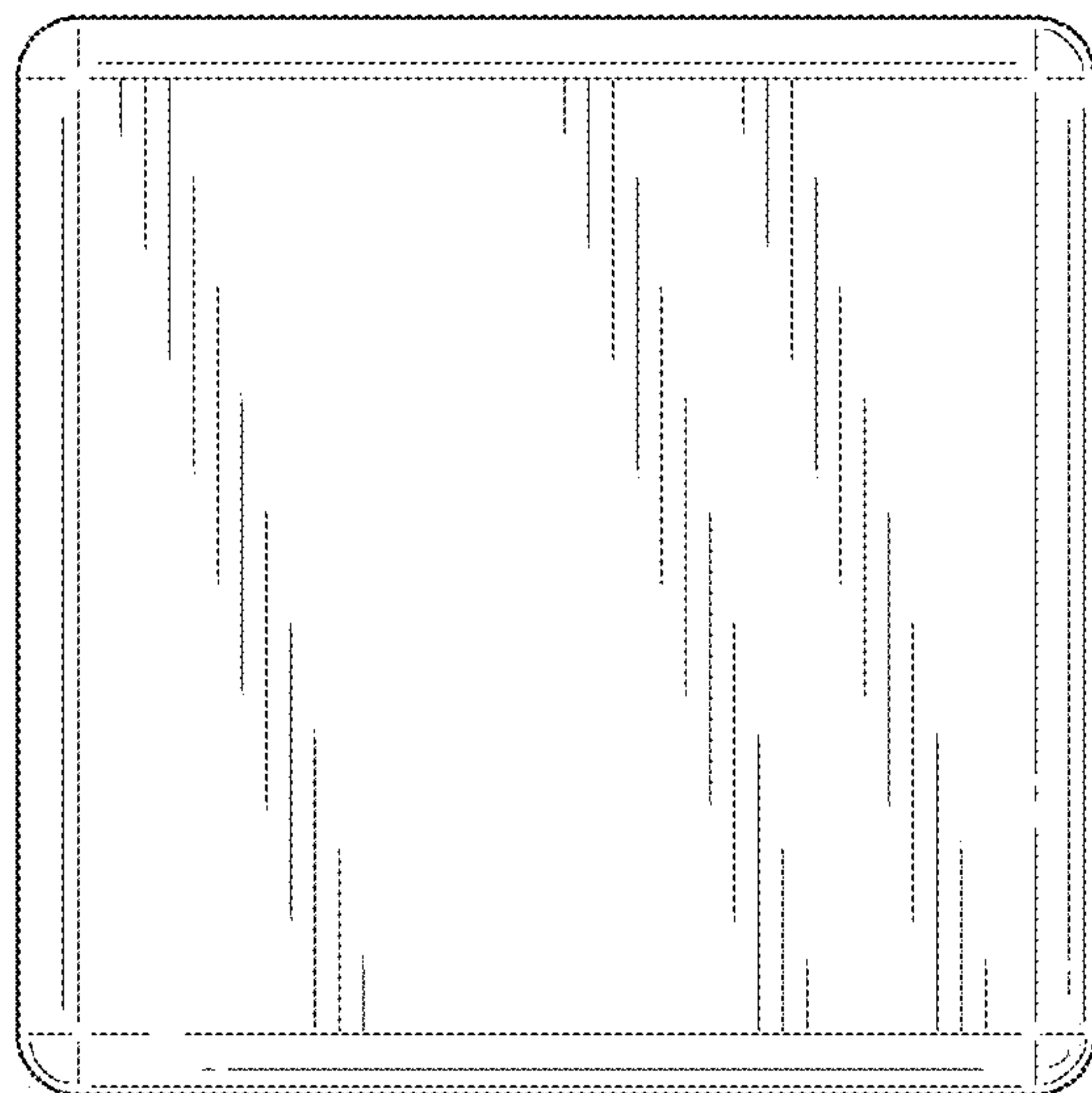

FIG. 33

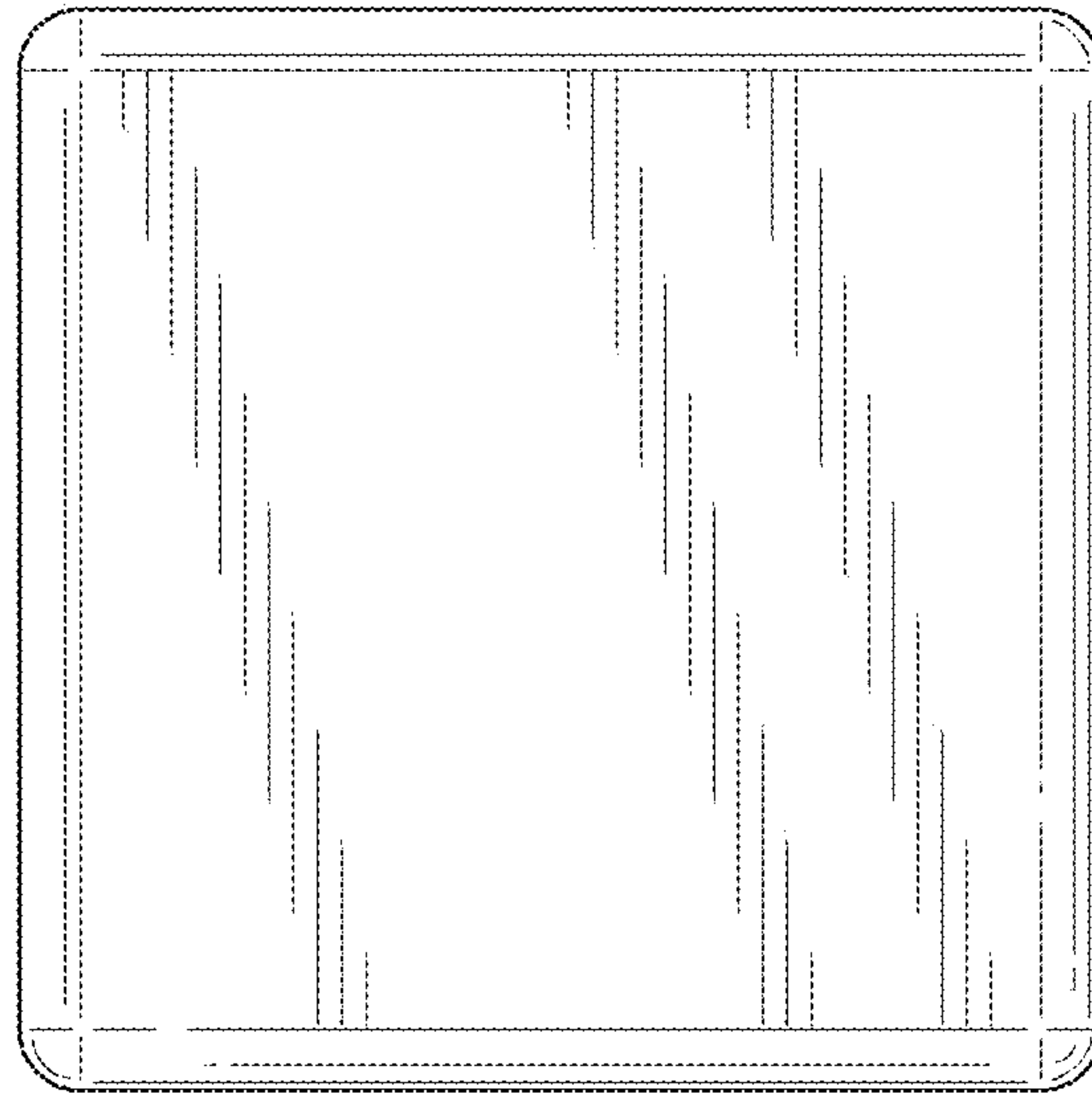

FIG. 34

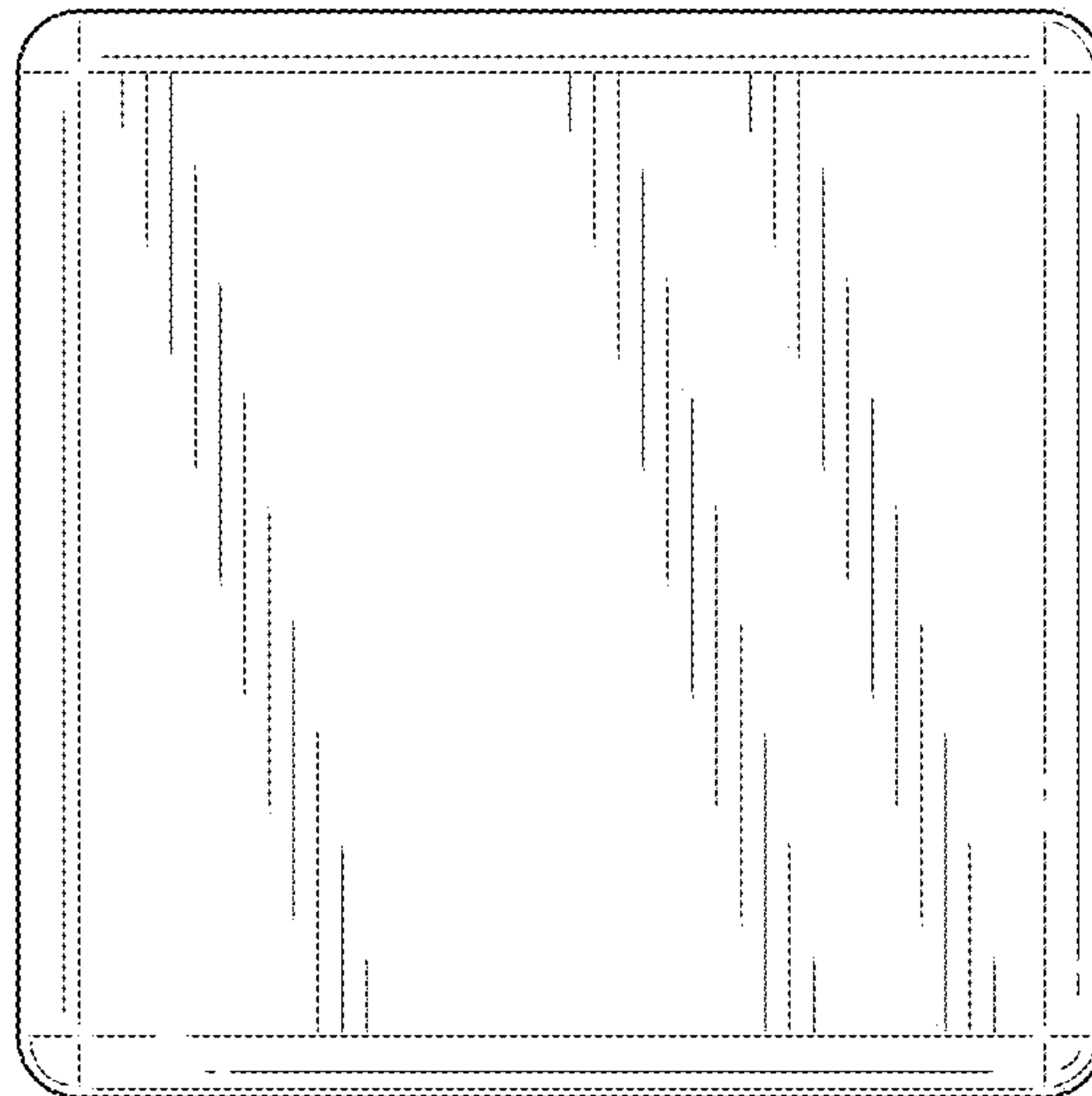

FIG. 35

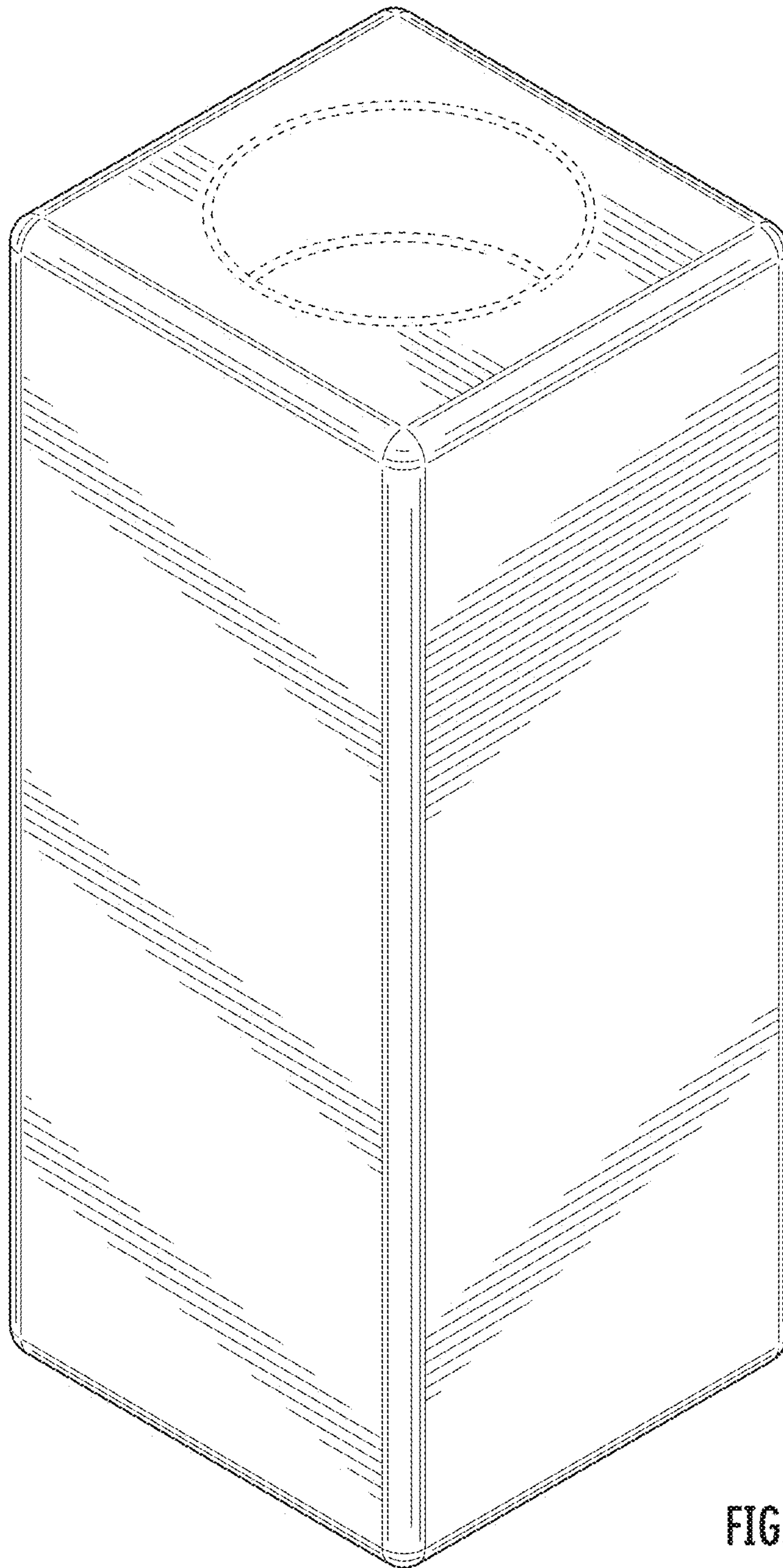

FIG. 36

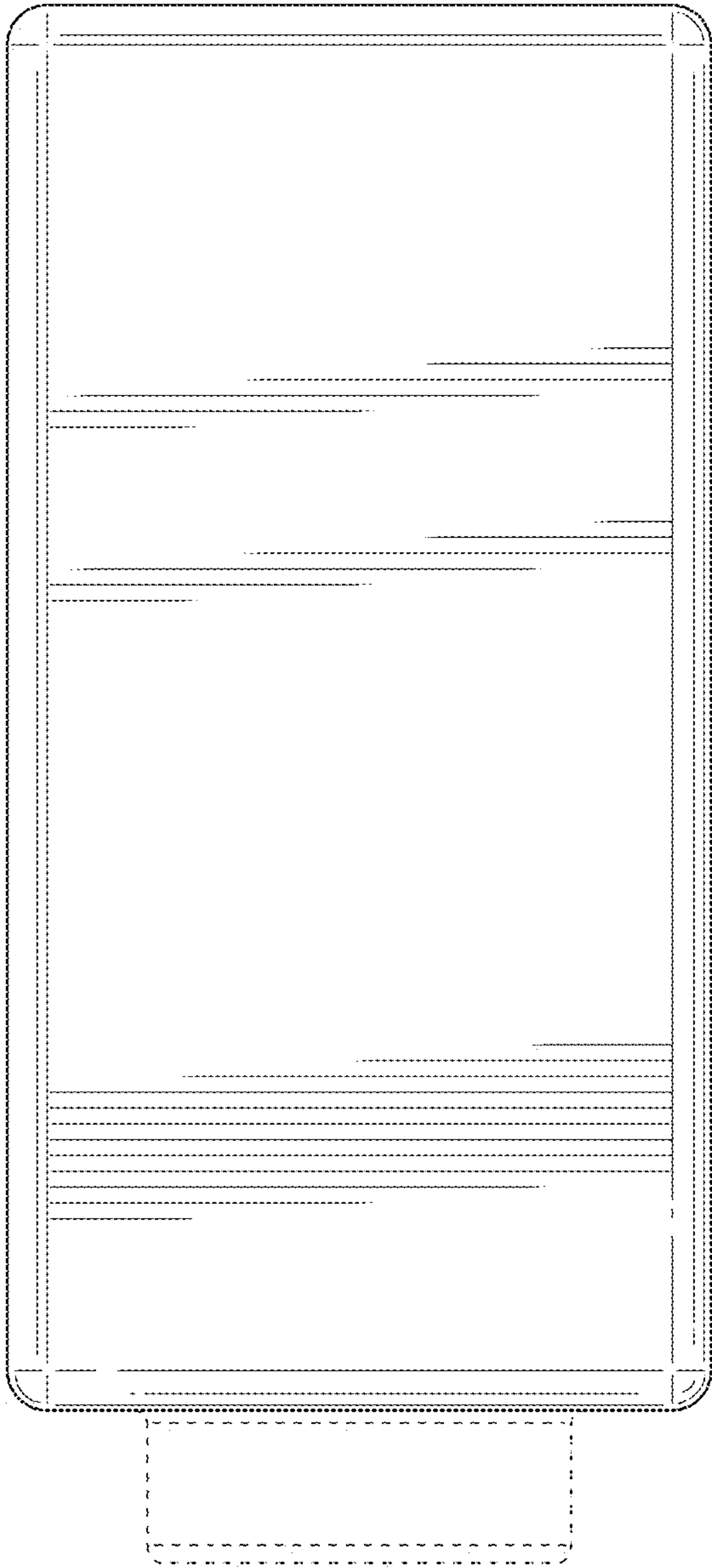

FIG. 37

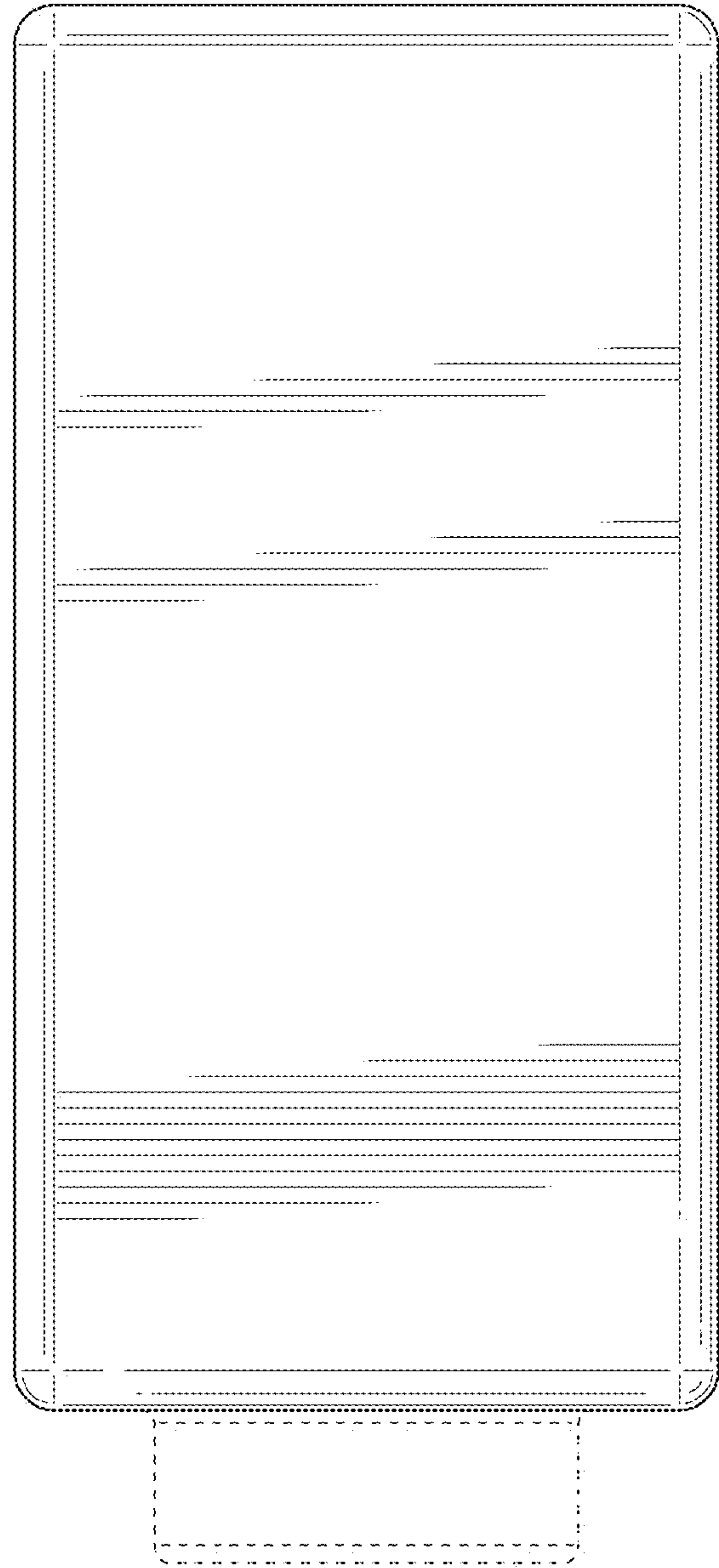

FIG. 38

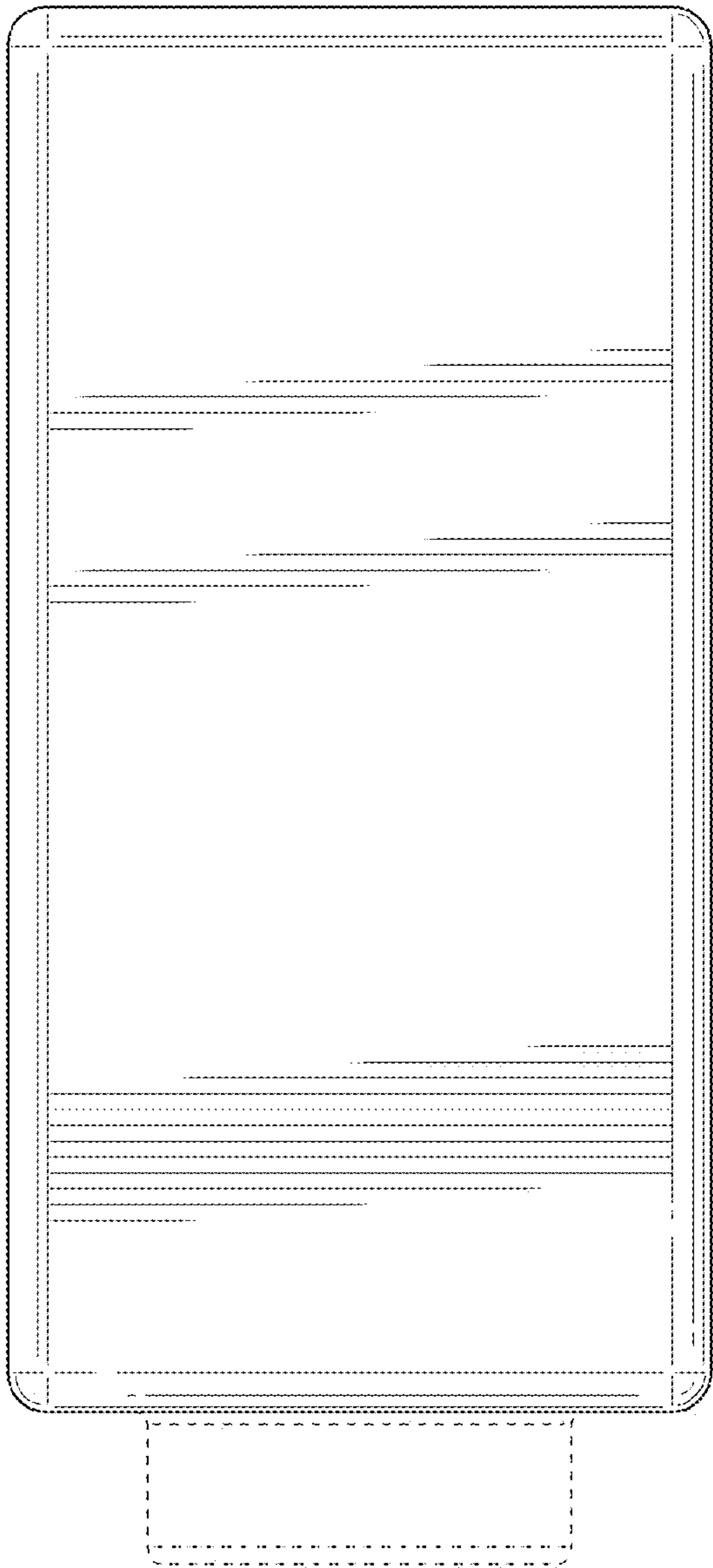

FIG. 39

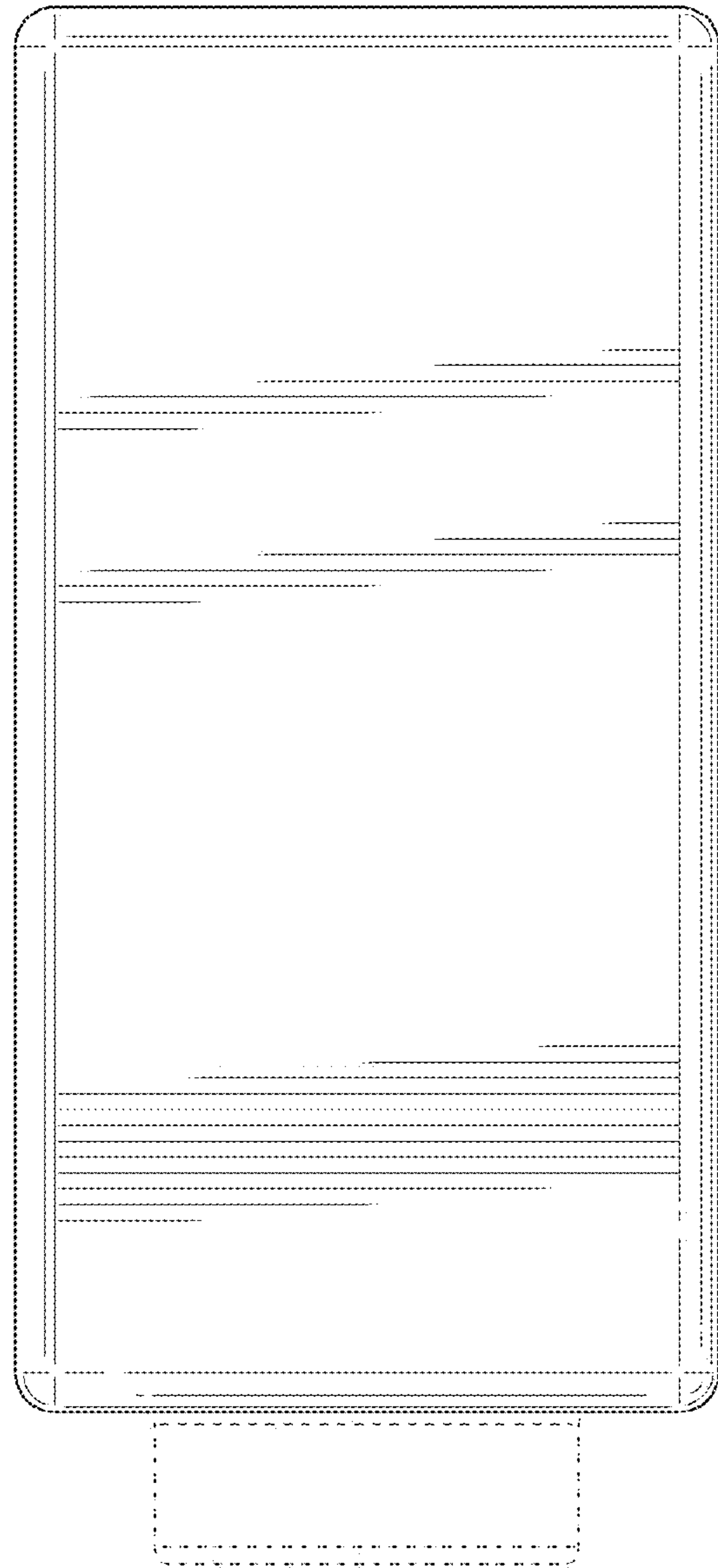

FIG. 40

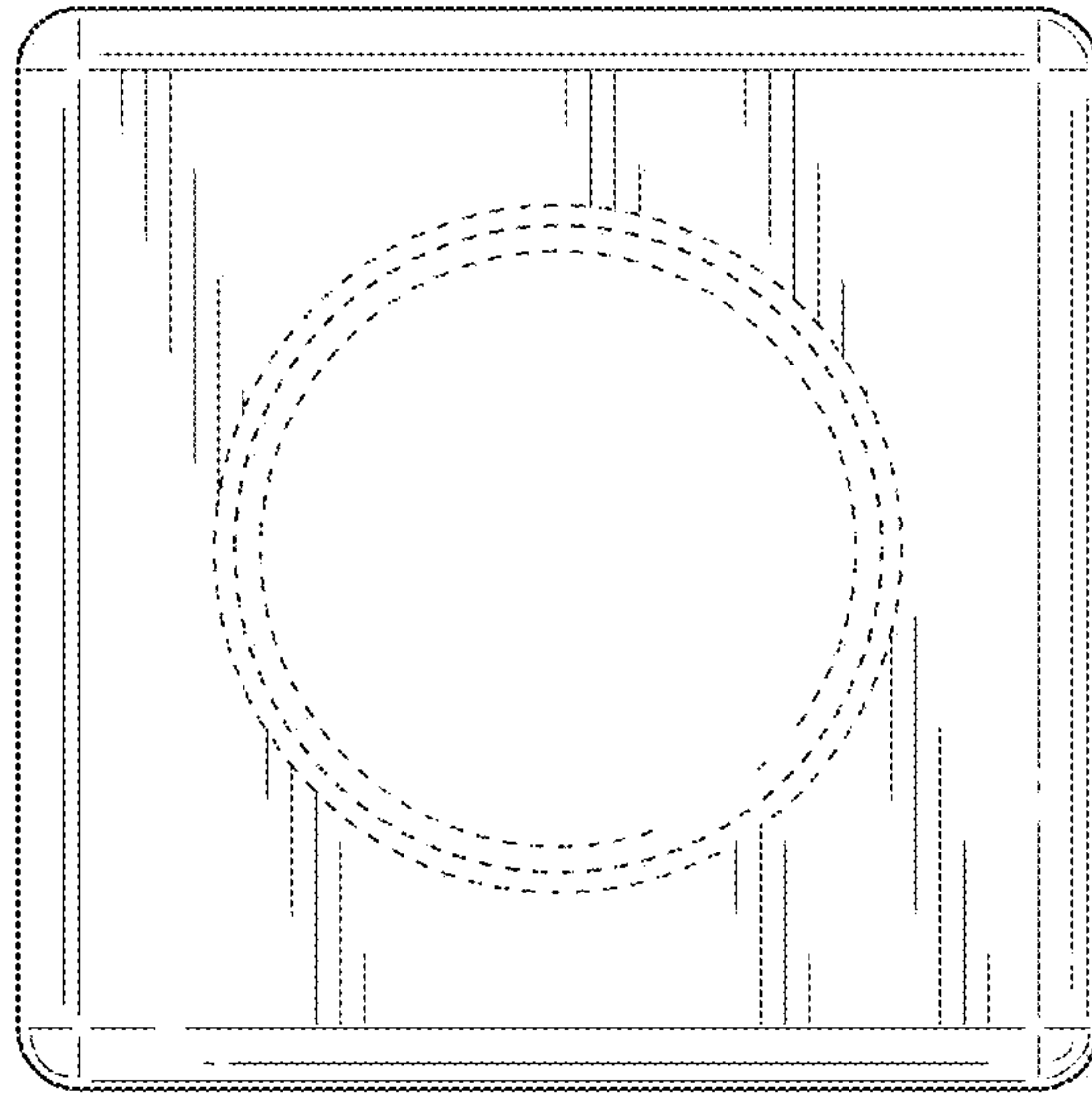

FIG. 41

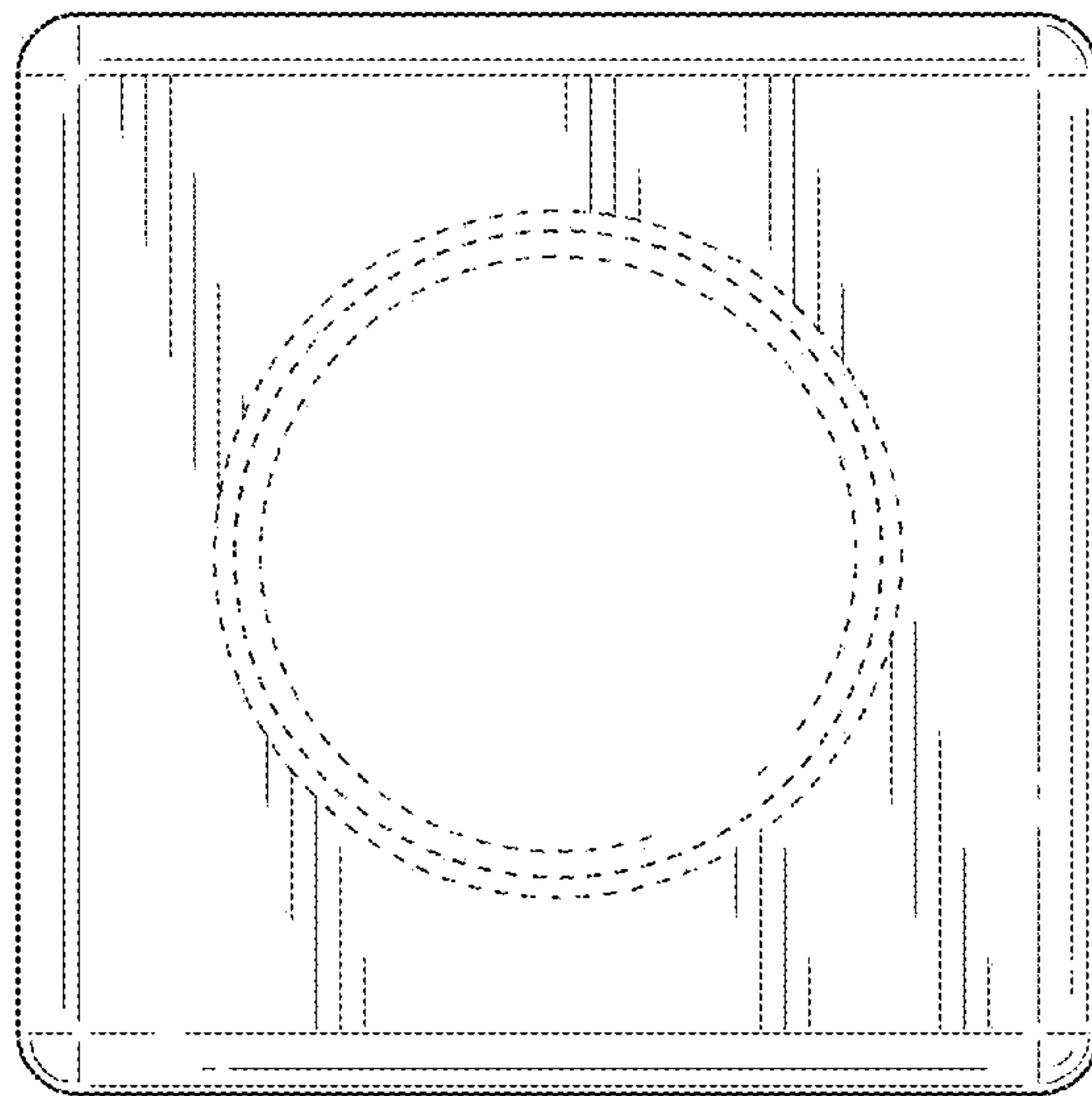

FIG. 42

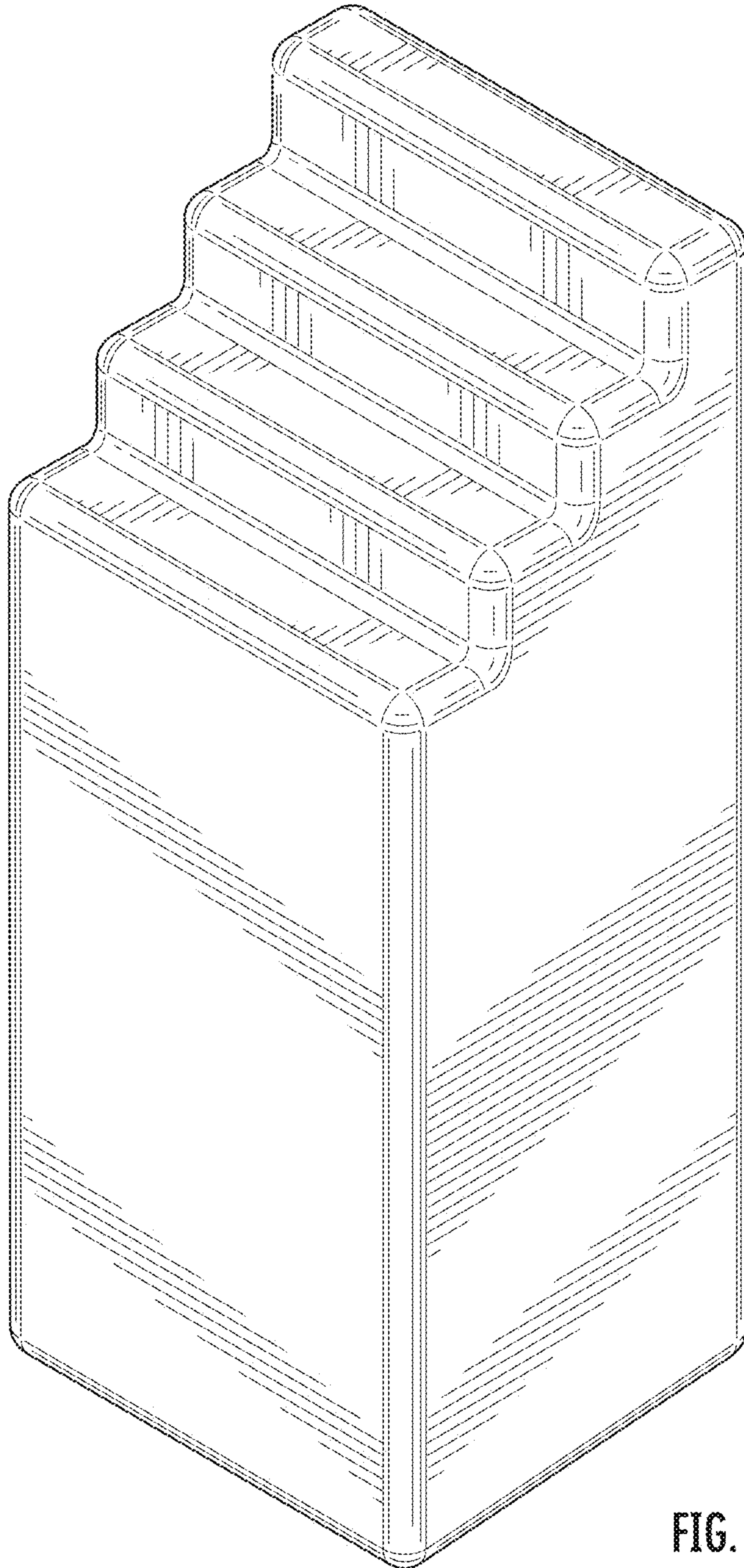

FIG. 43

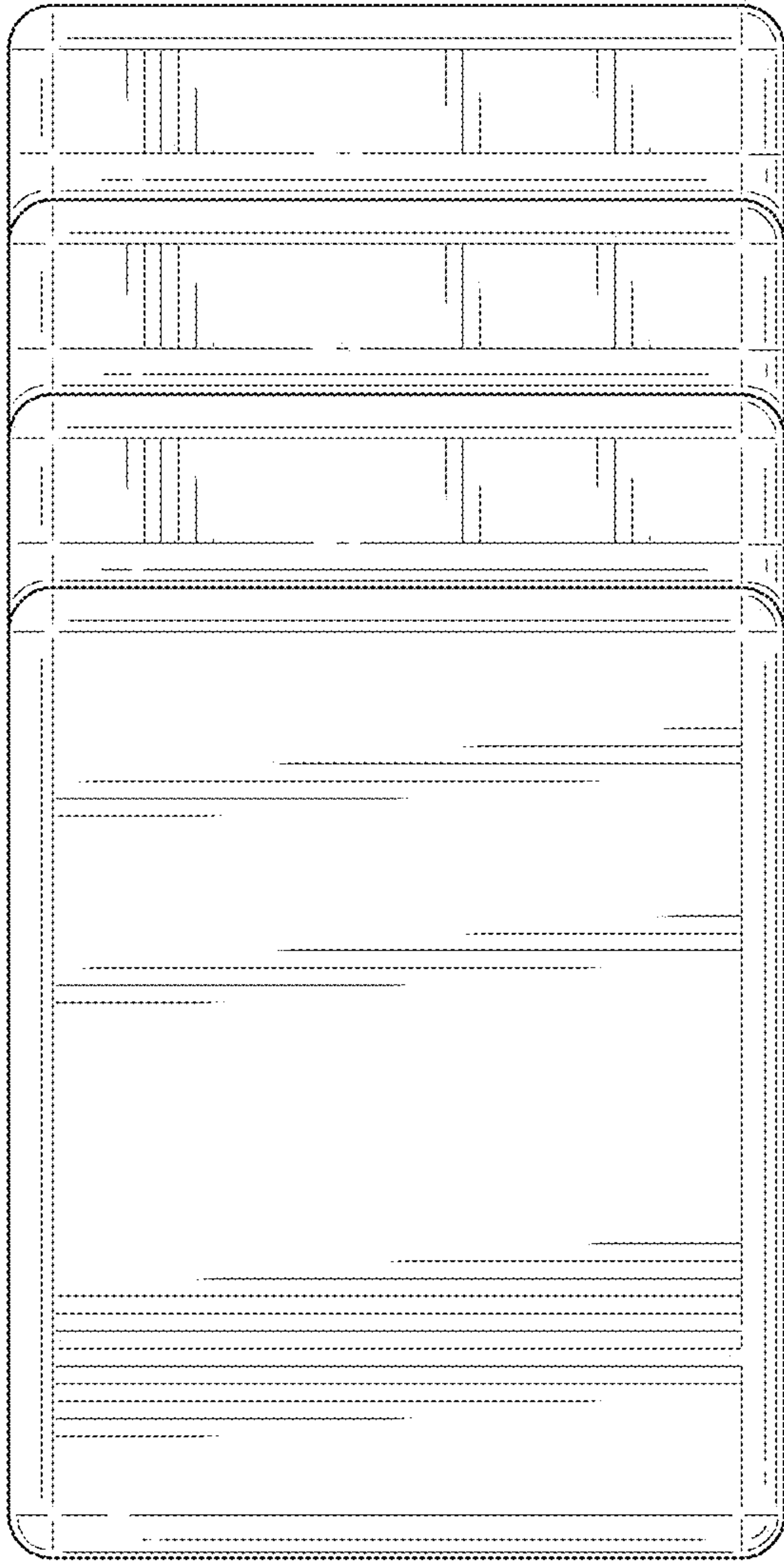

FIG. 44

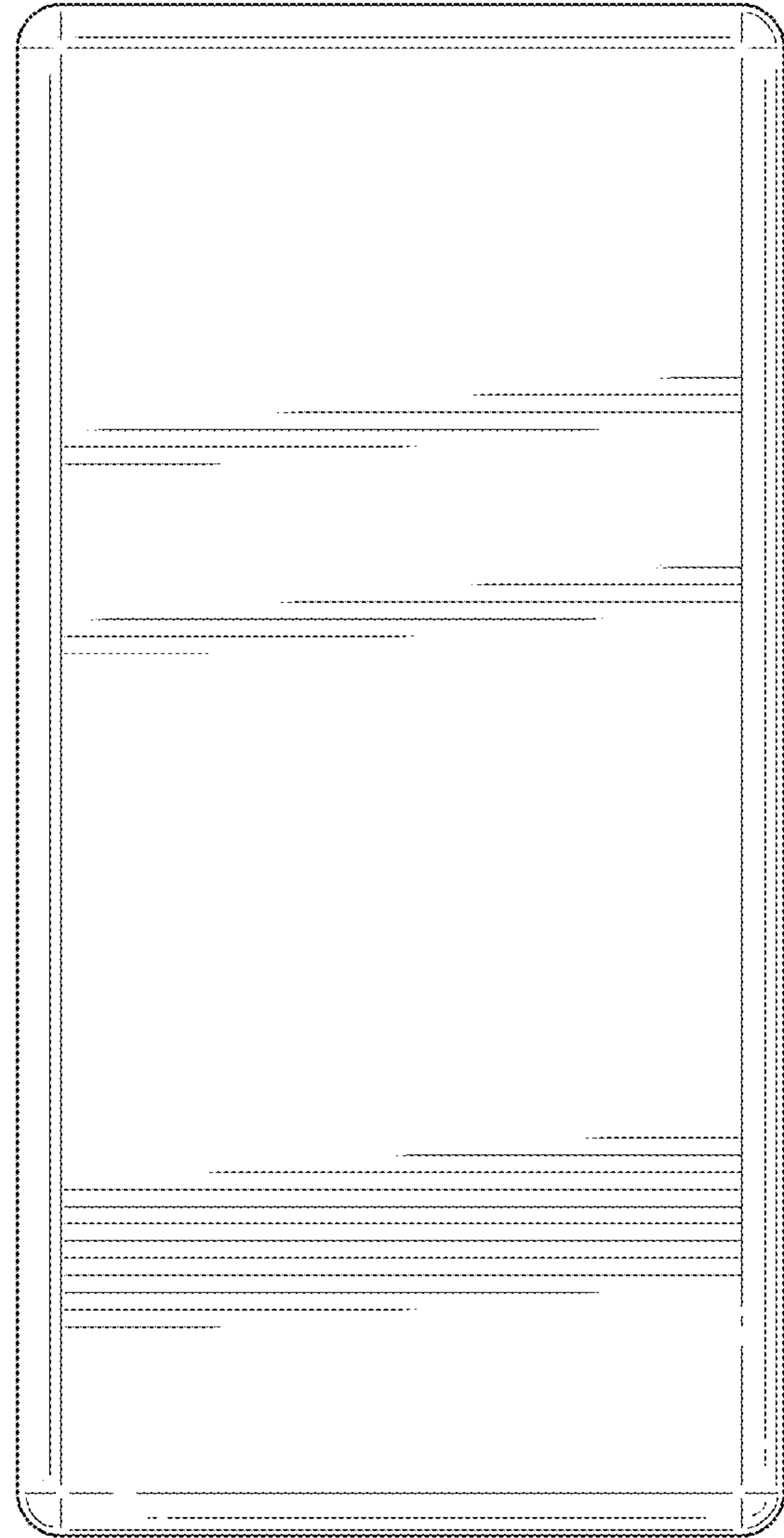

FIG. 45

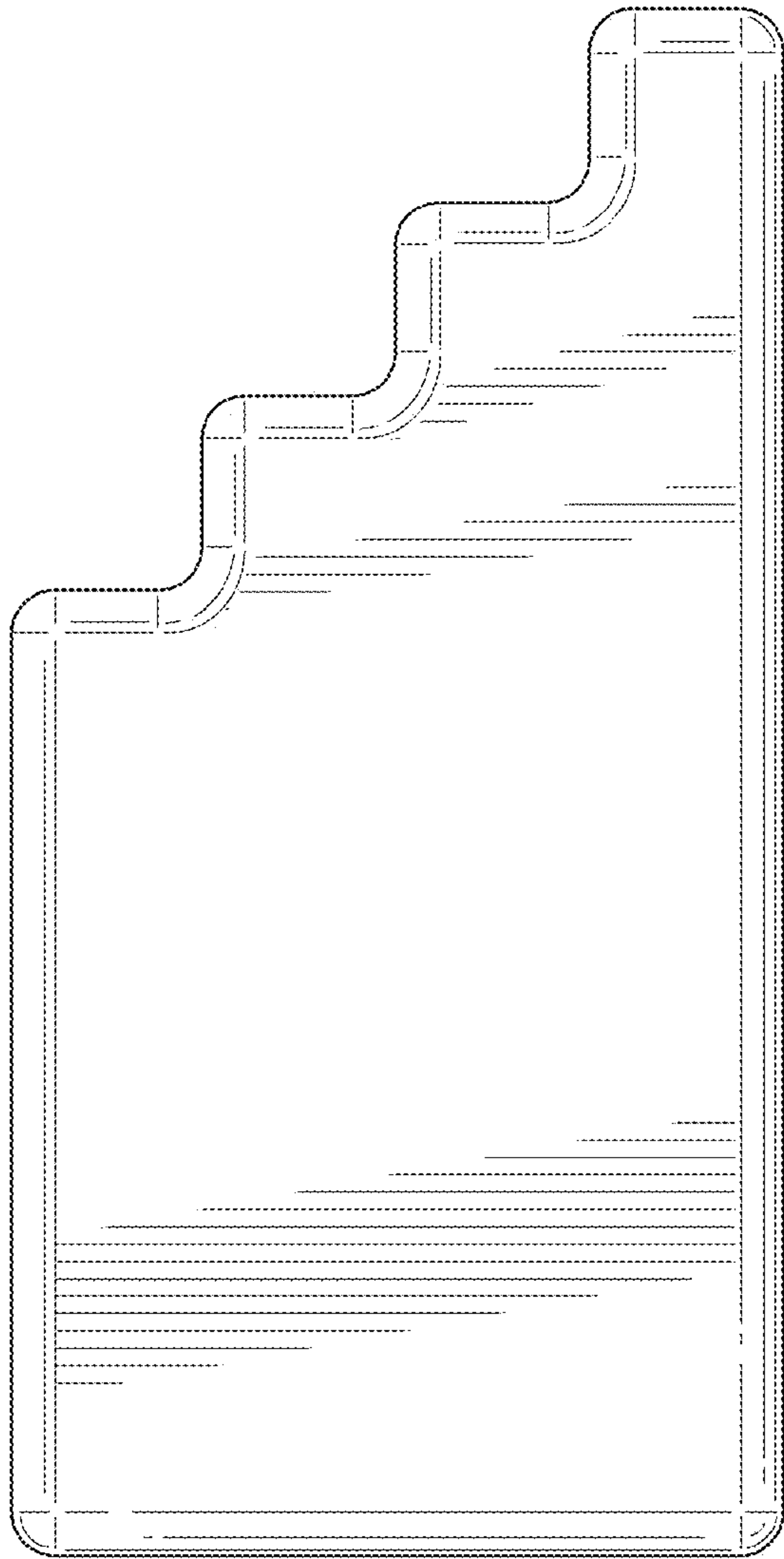

FIG. 46

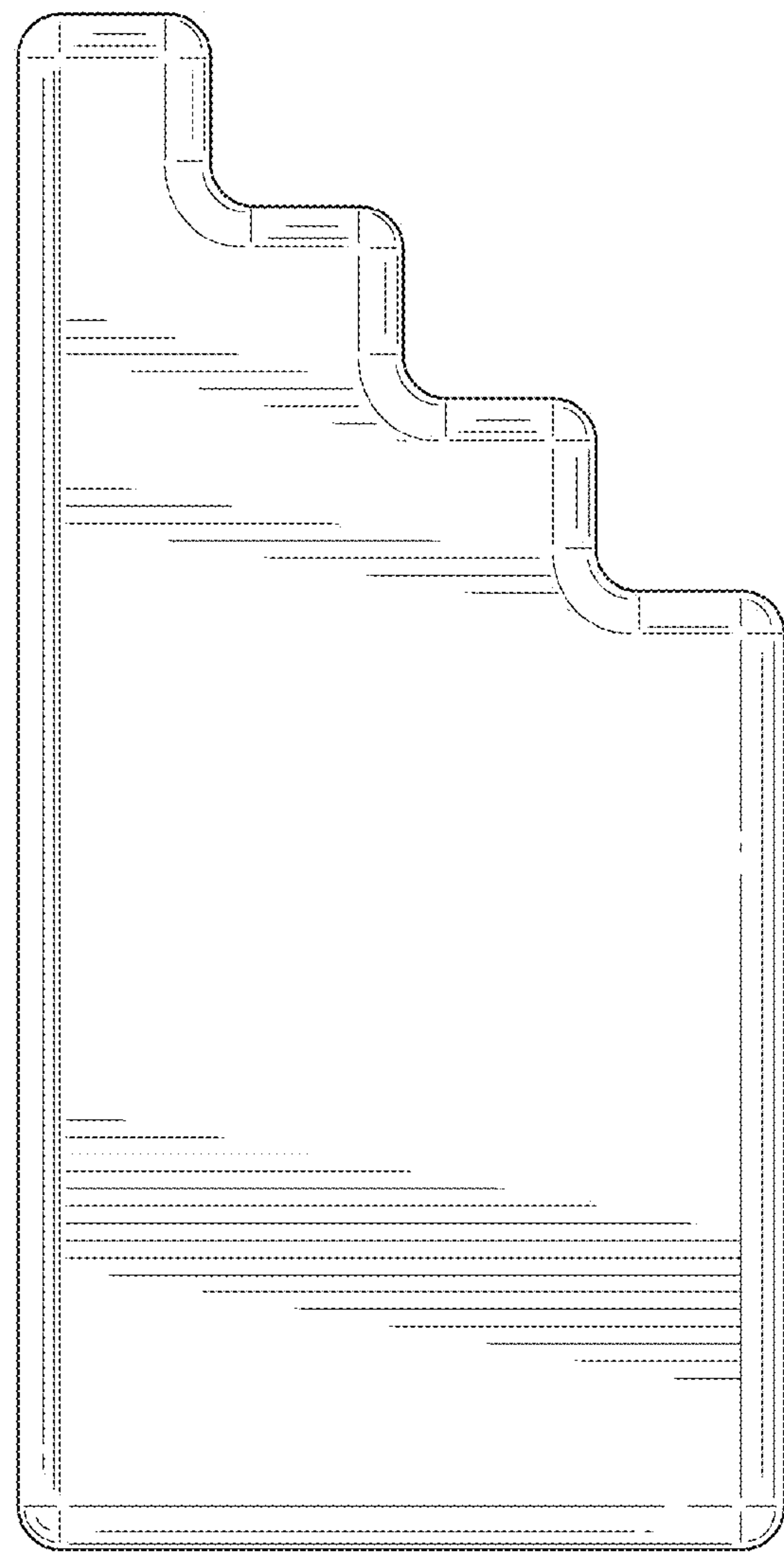

FIG. 47

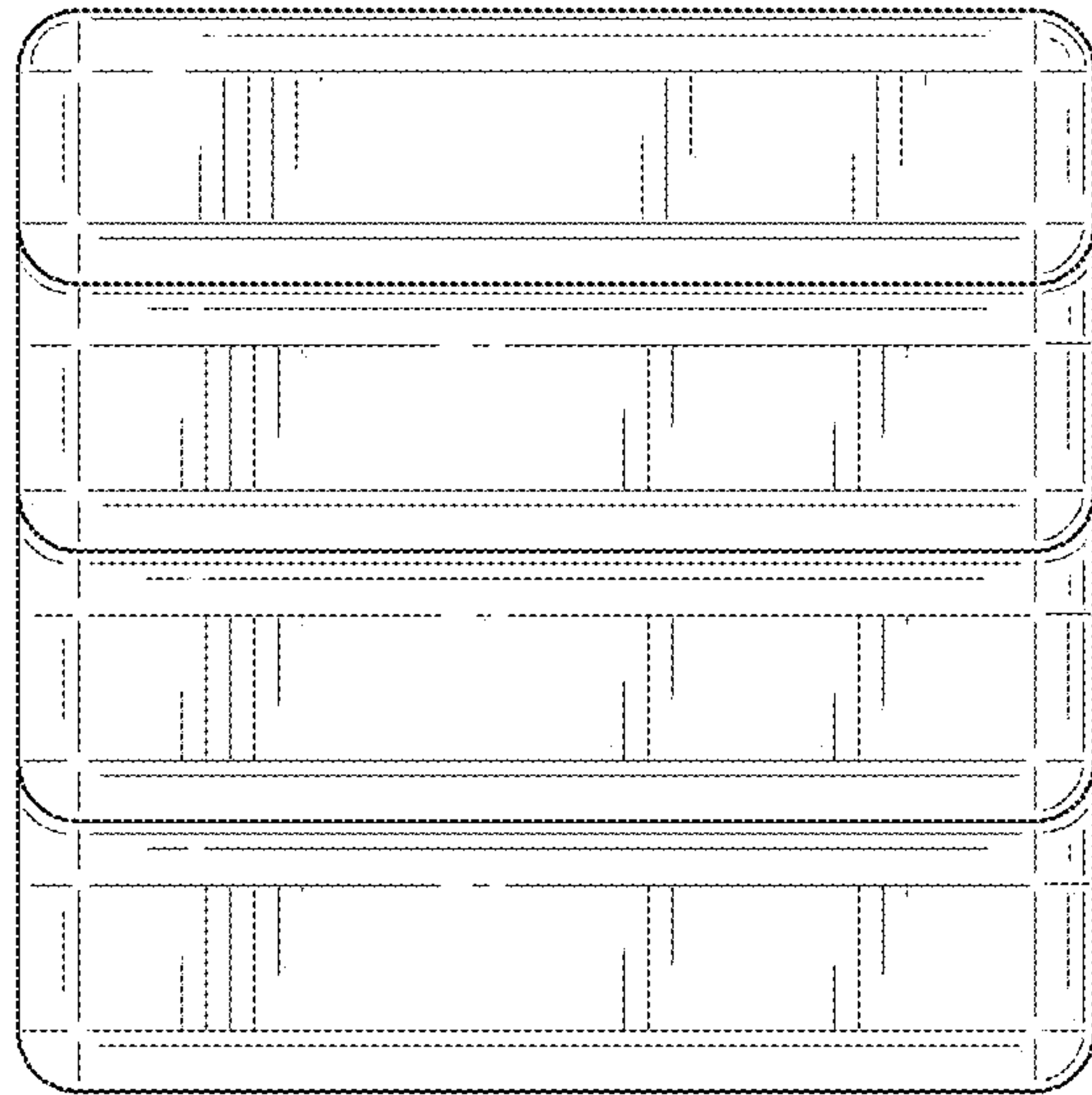

FIG. 48

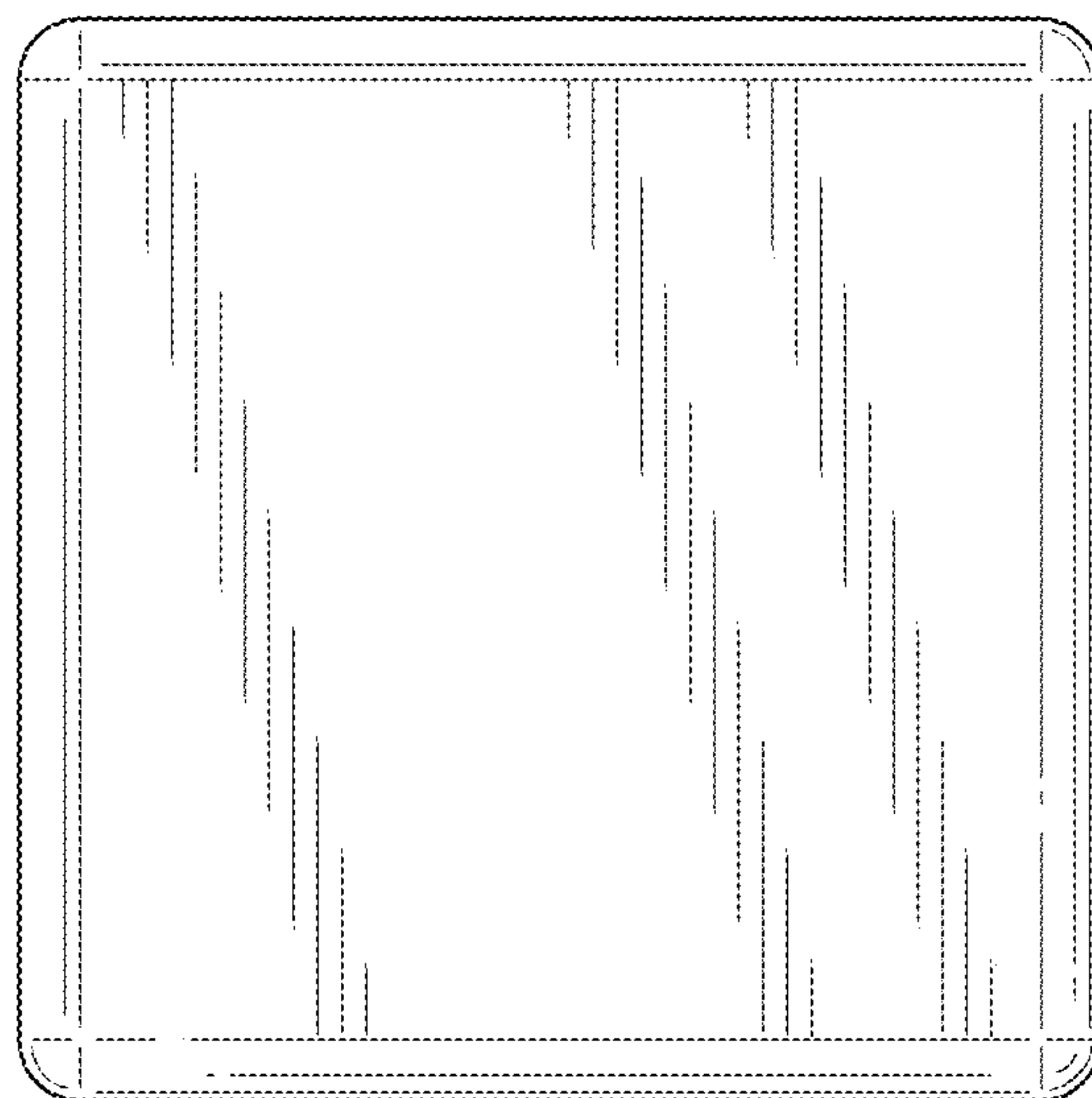

FIG. 49

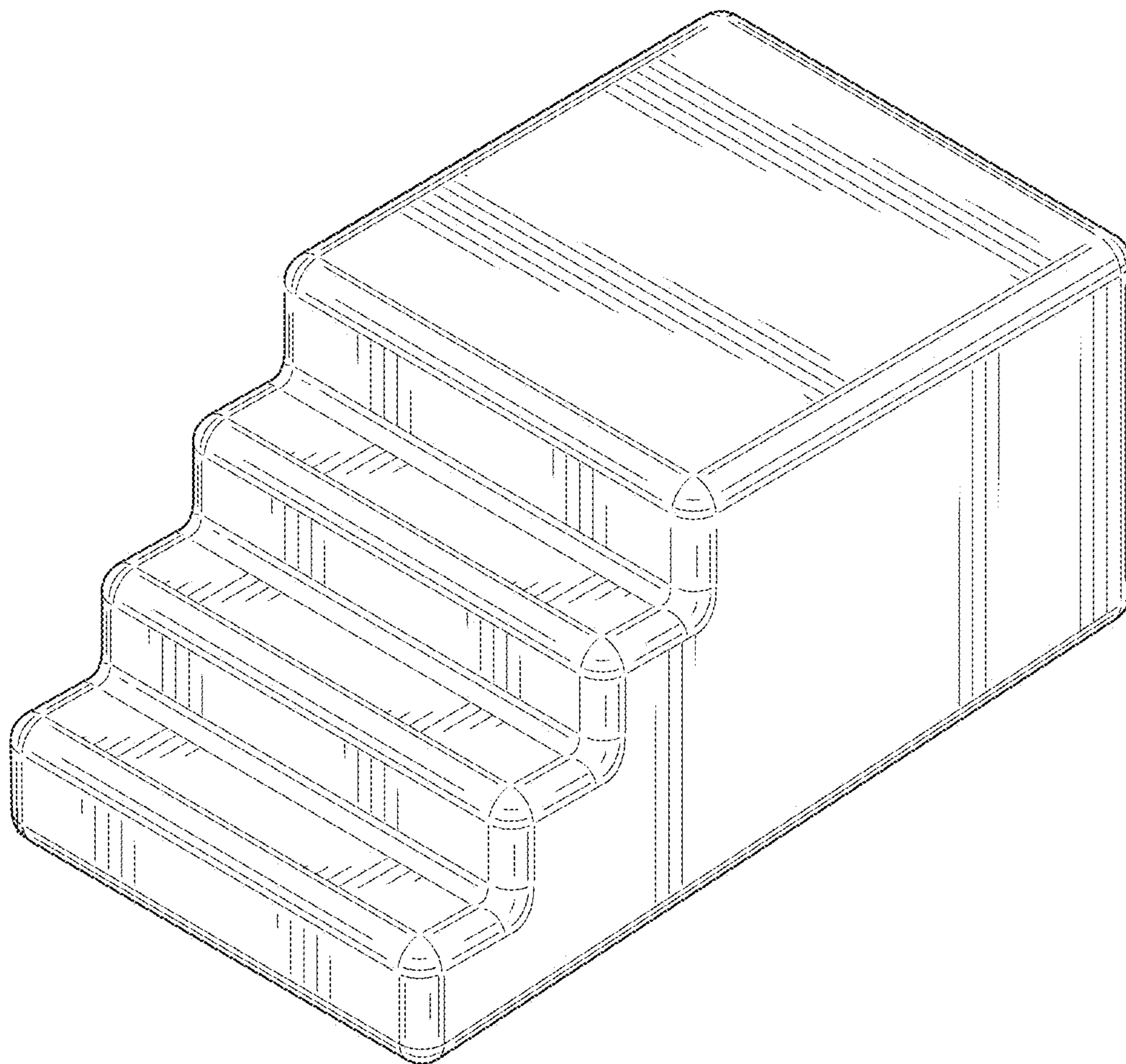

FIG. 50

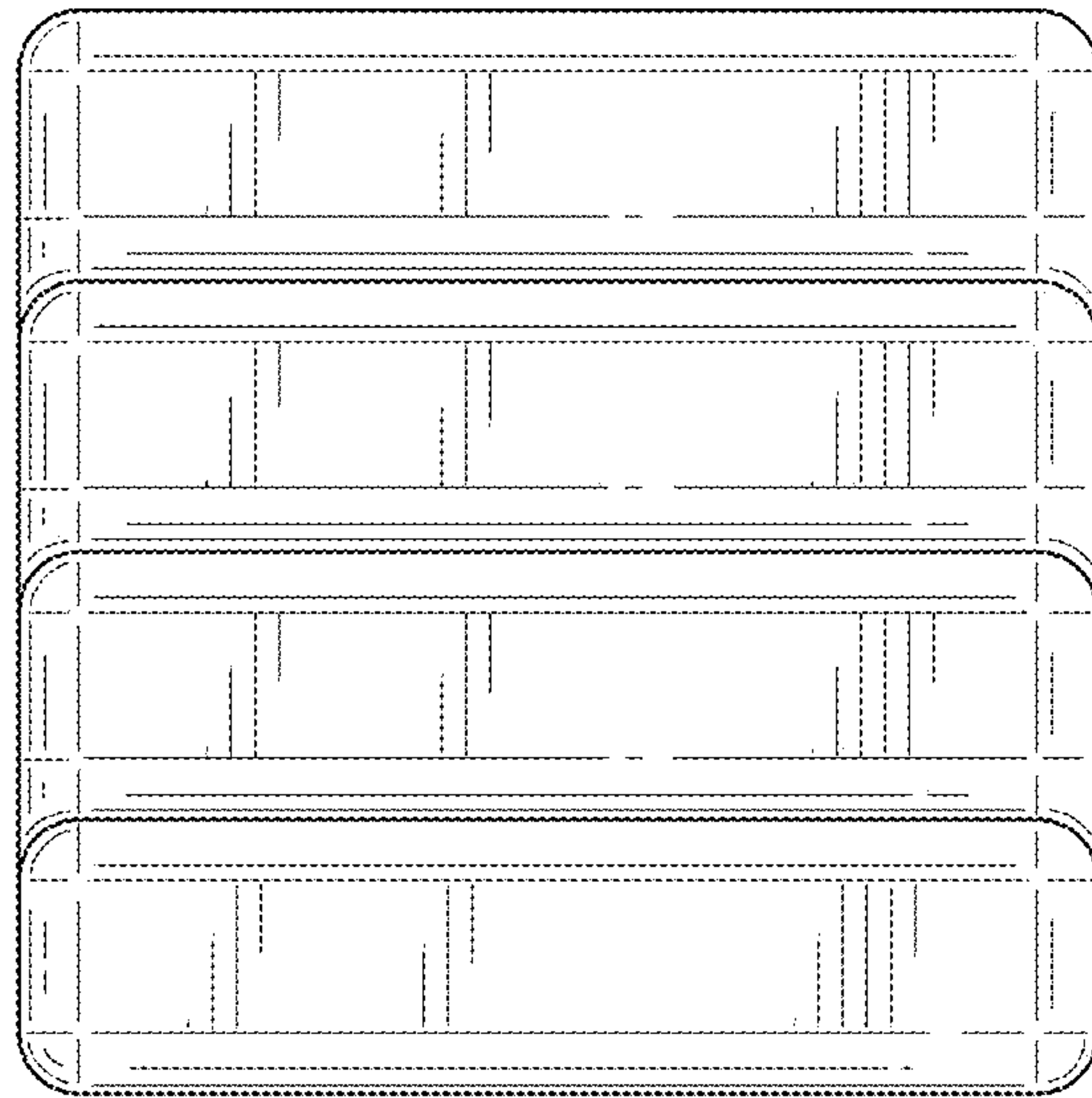

FIG. 51

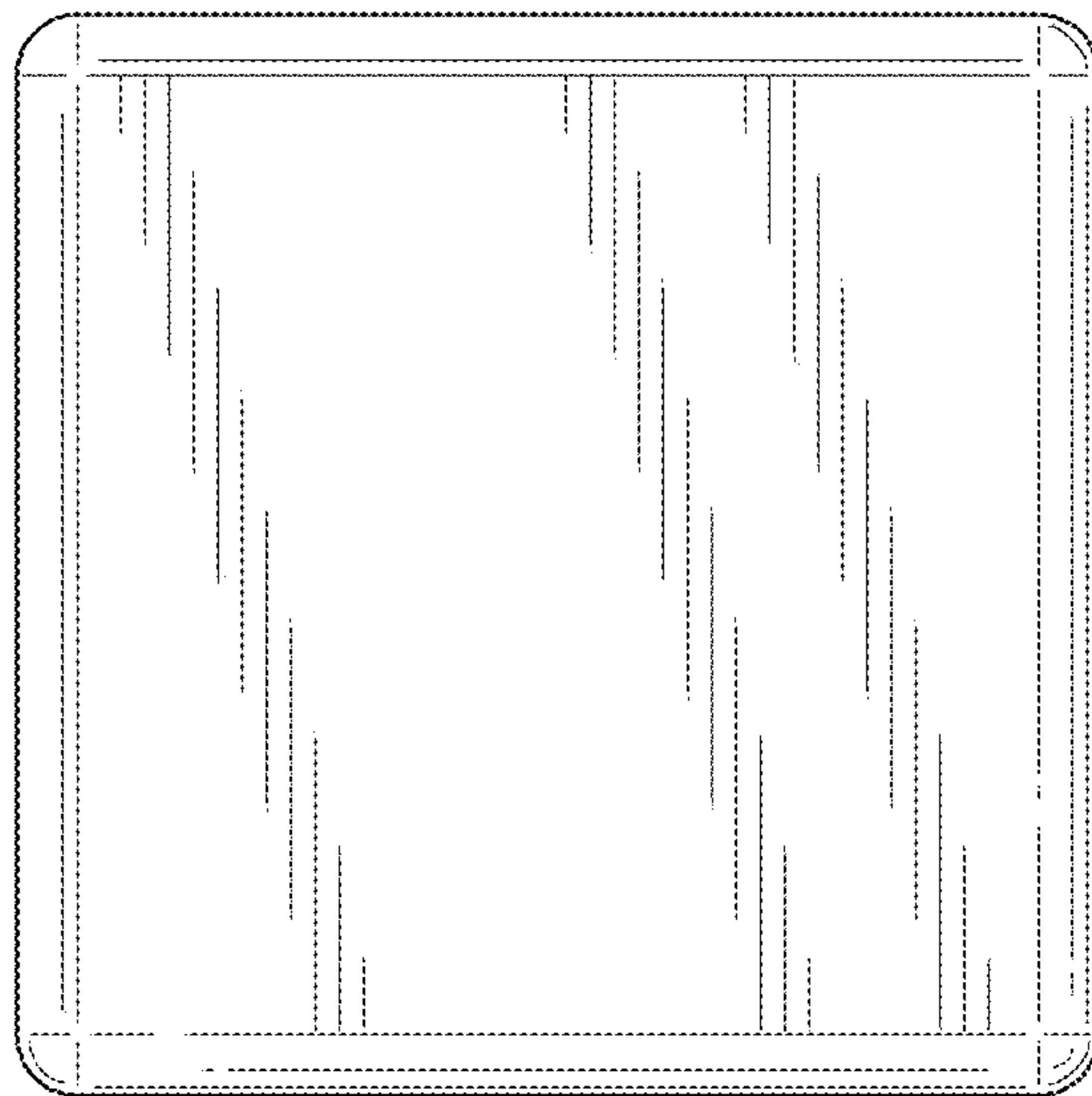

FIG. 52

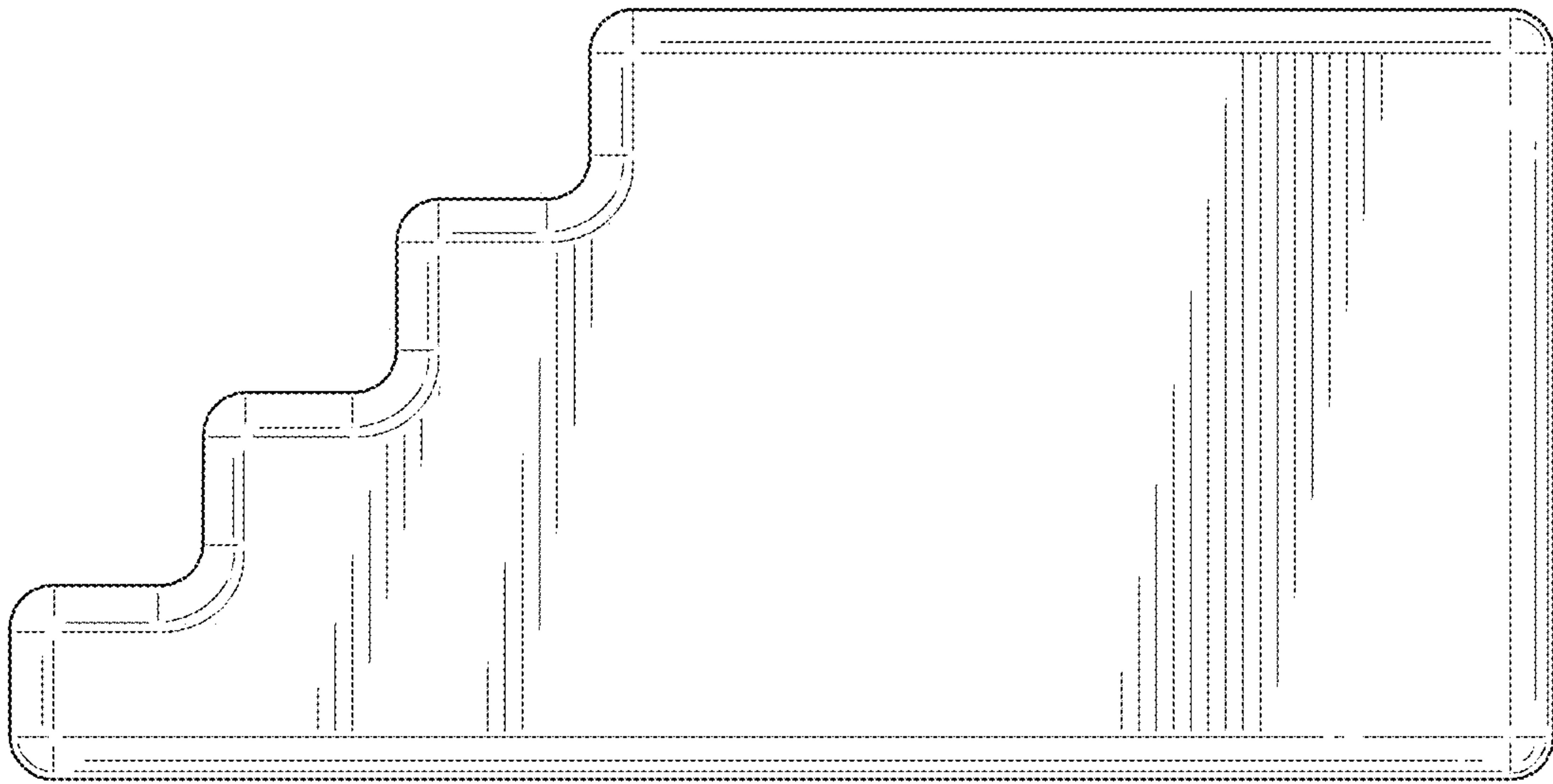

FIG. 53

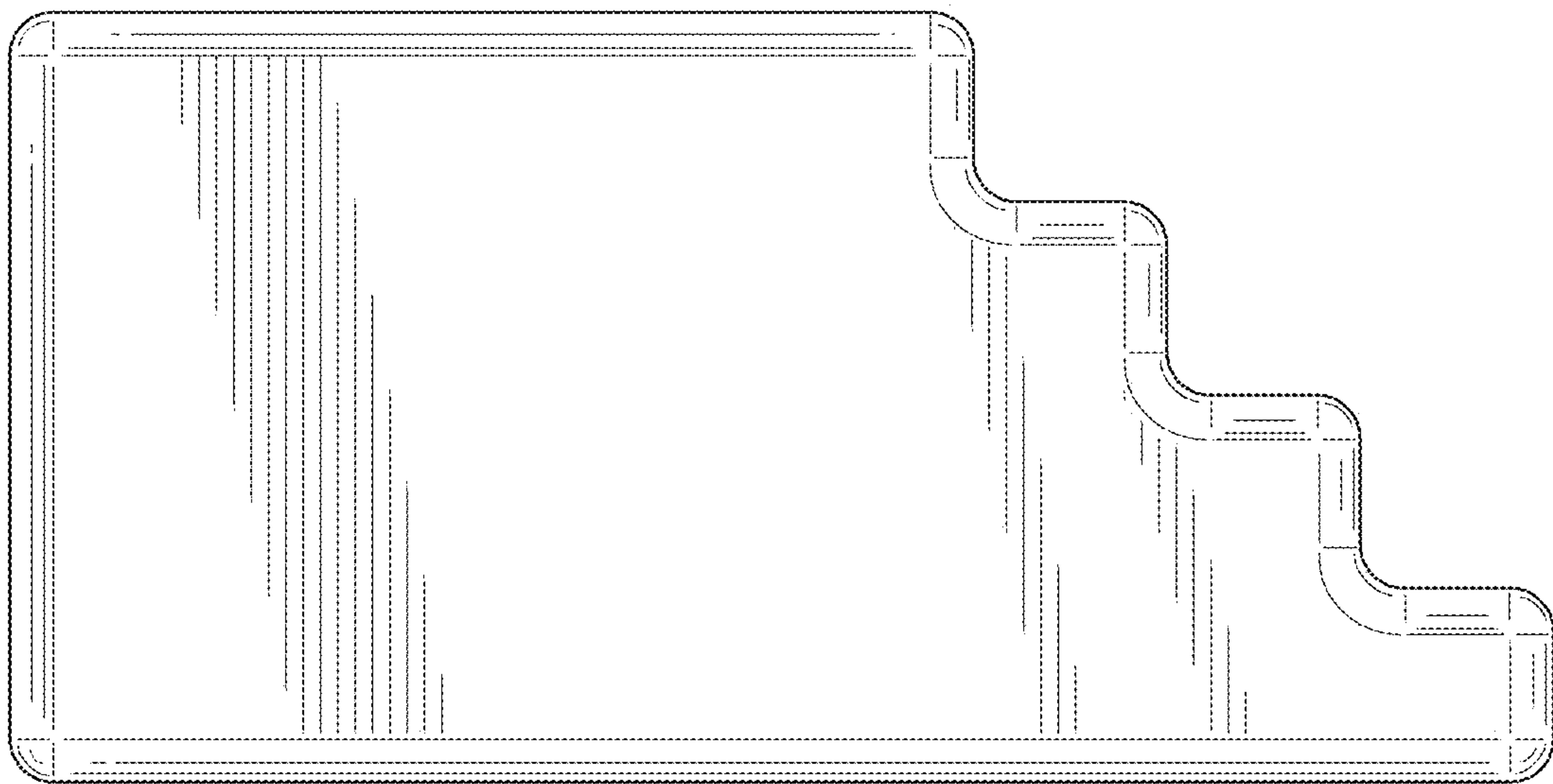

FIG. 54

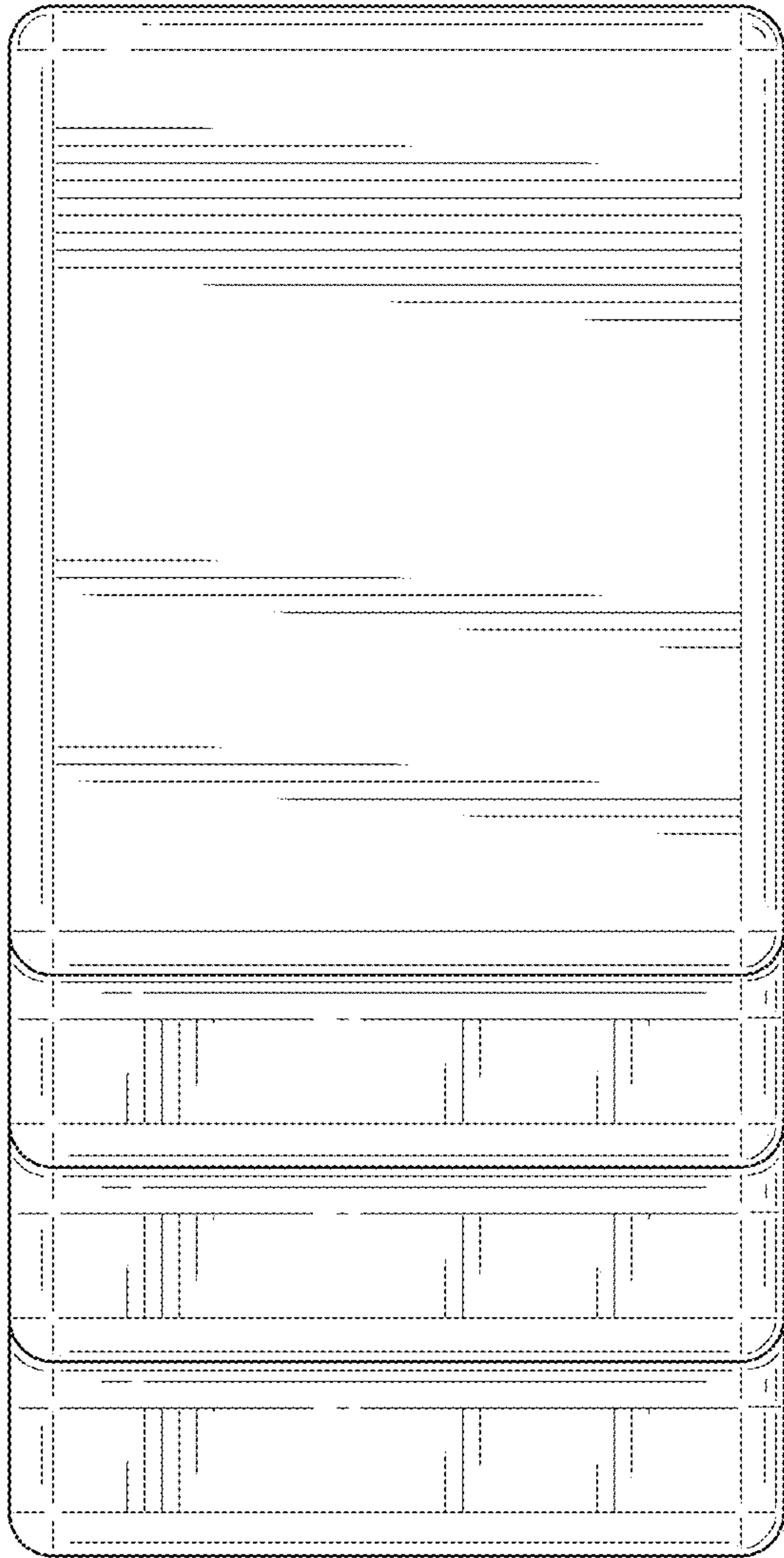

FIG. 55

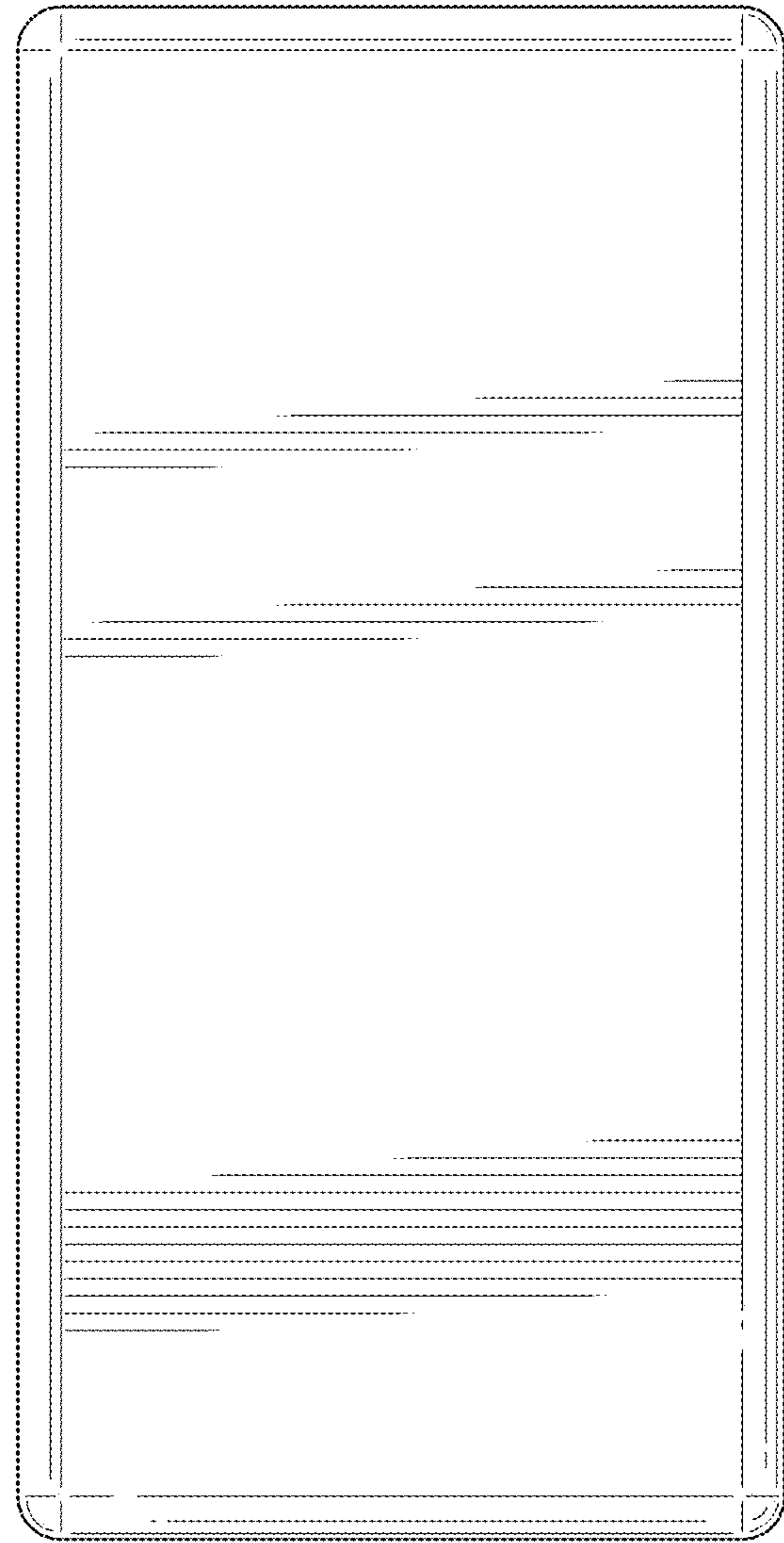

FIG. 56

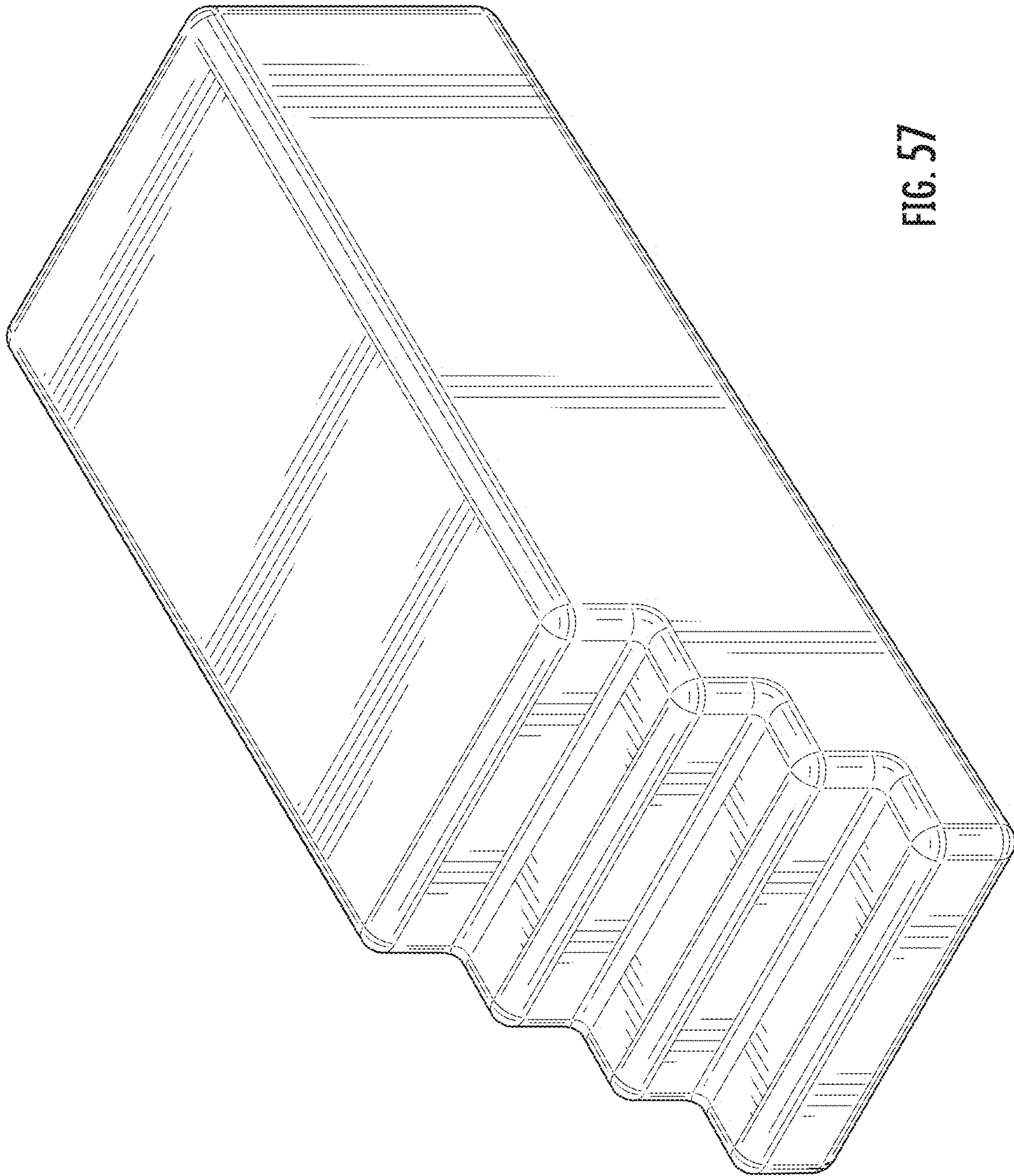

FIG. 57

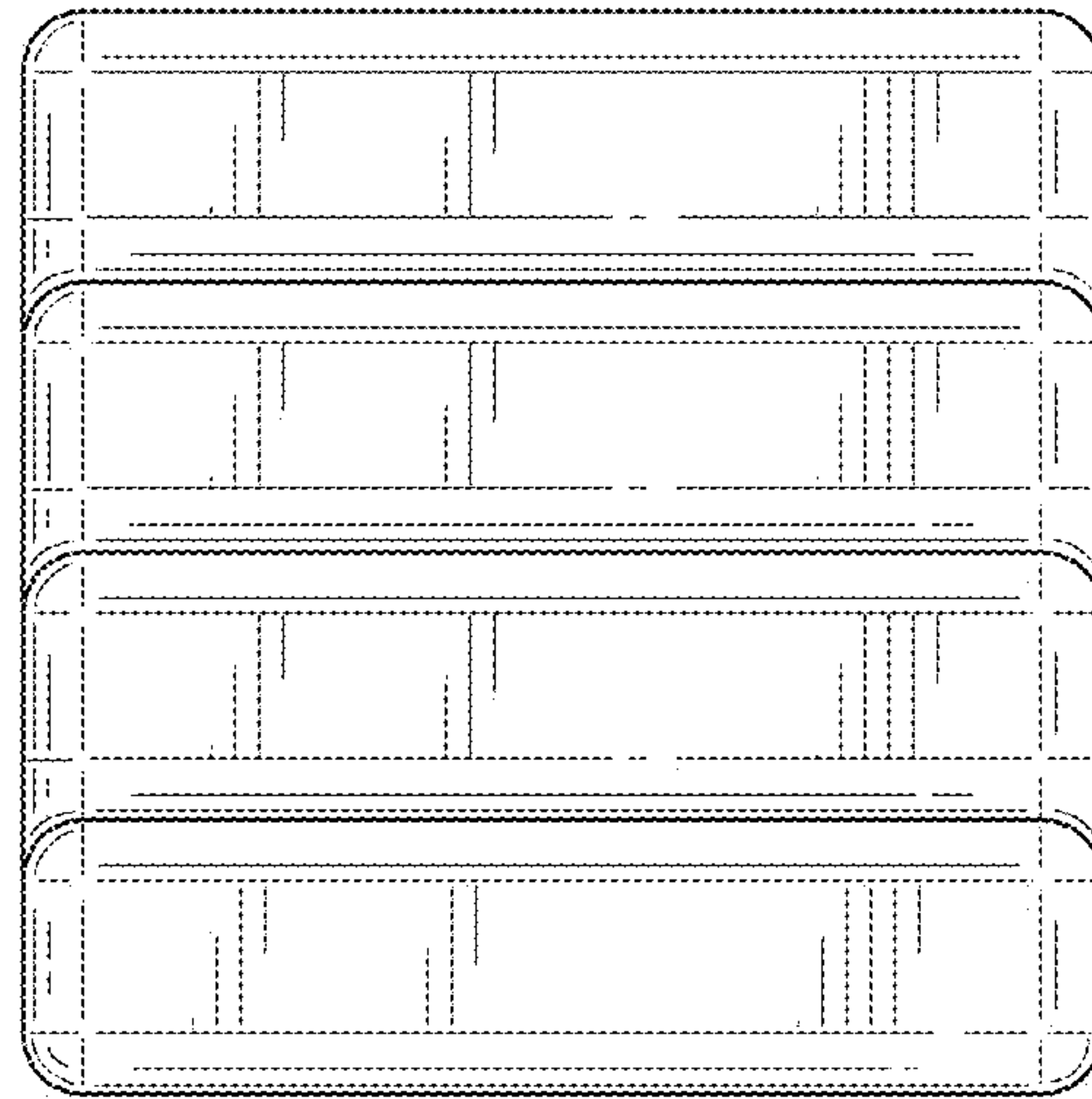

FIG. 58

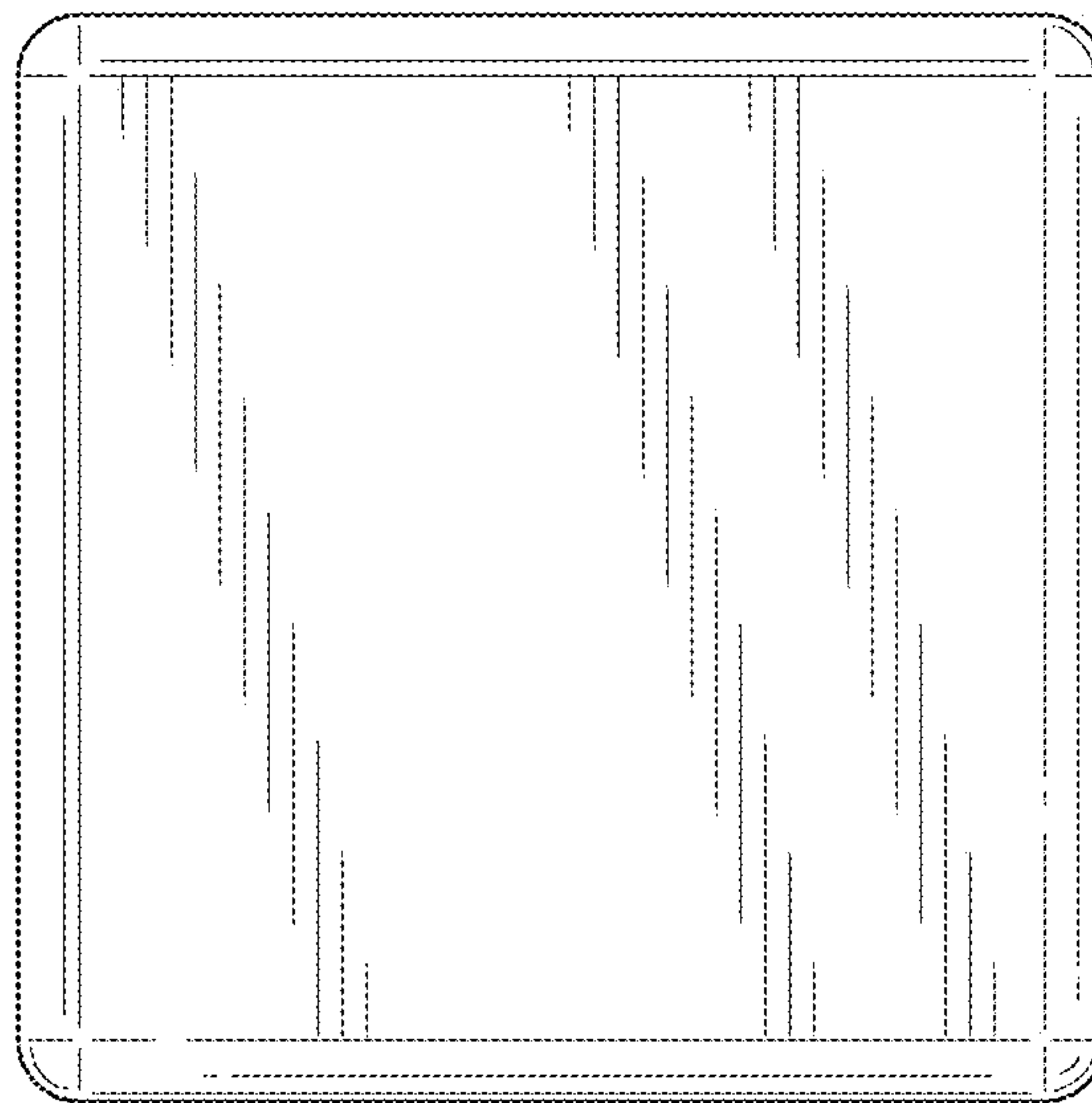

FIG. 59

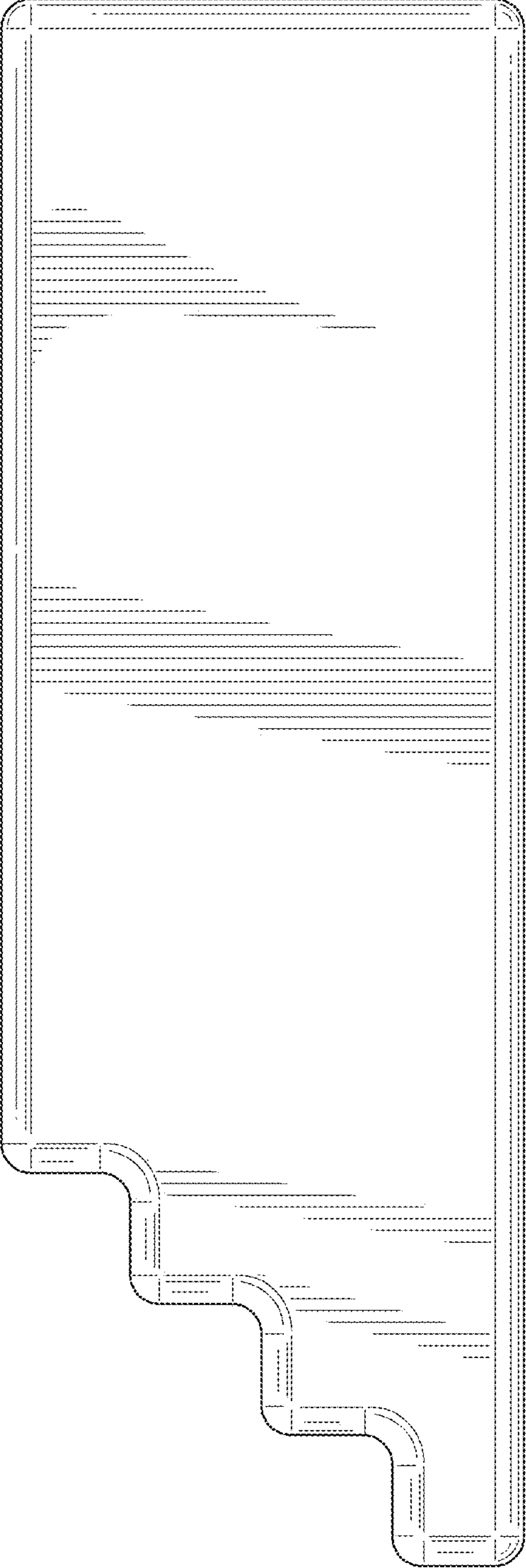

FIG. 60

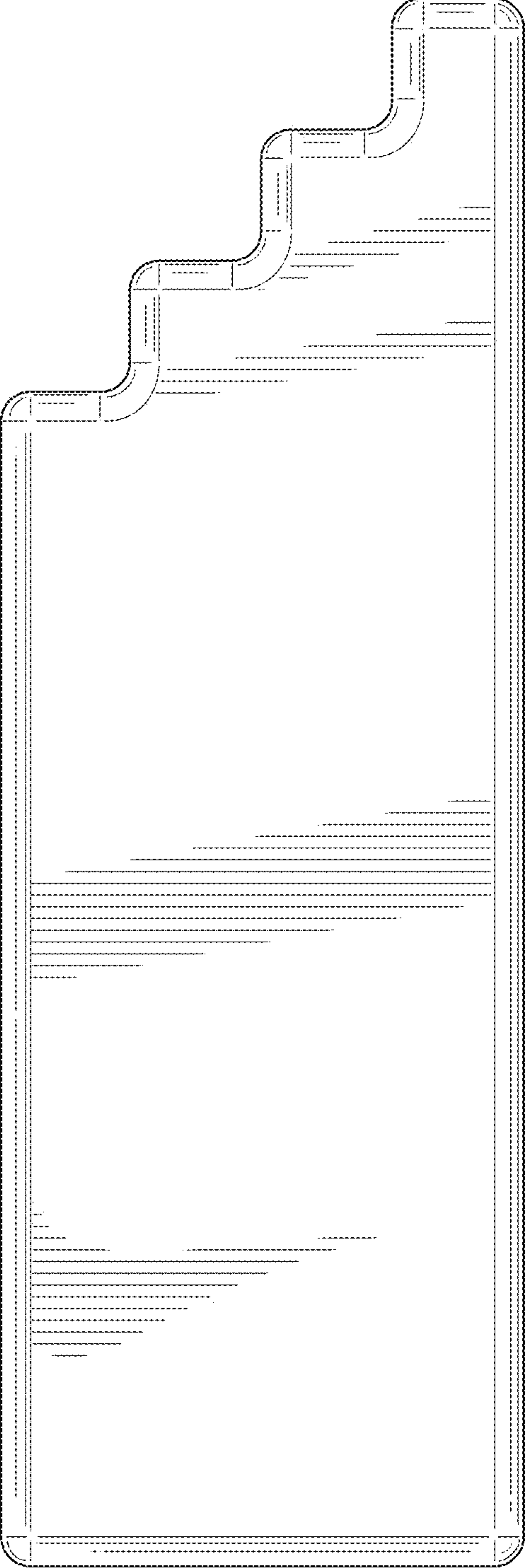

FIG. 61

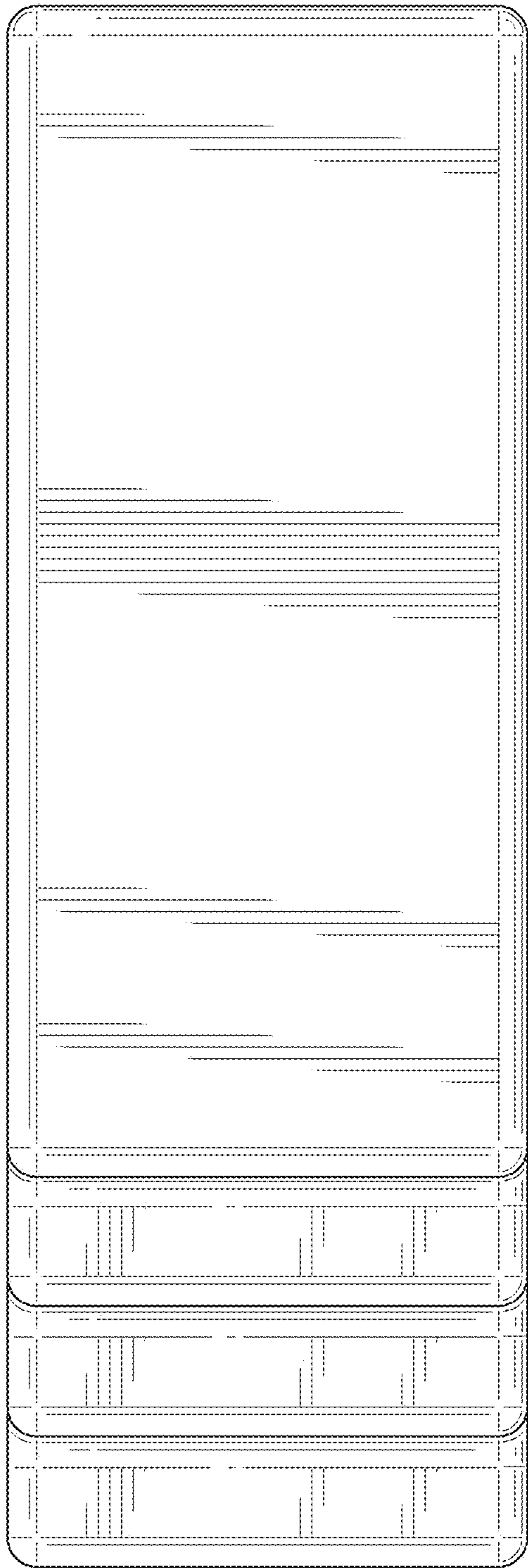

FIG. 62

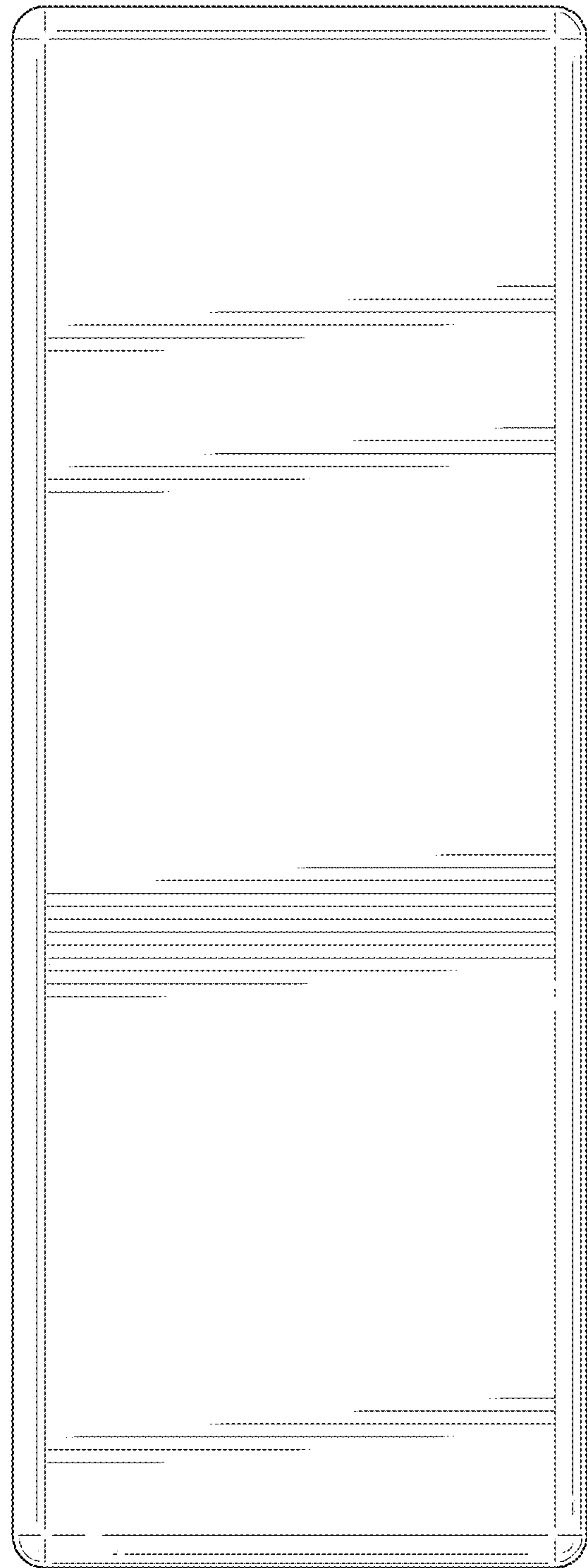

FIG. 63

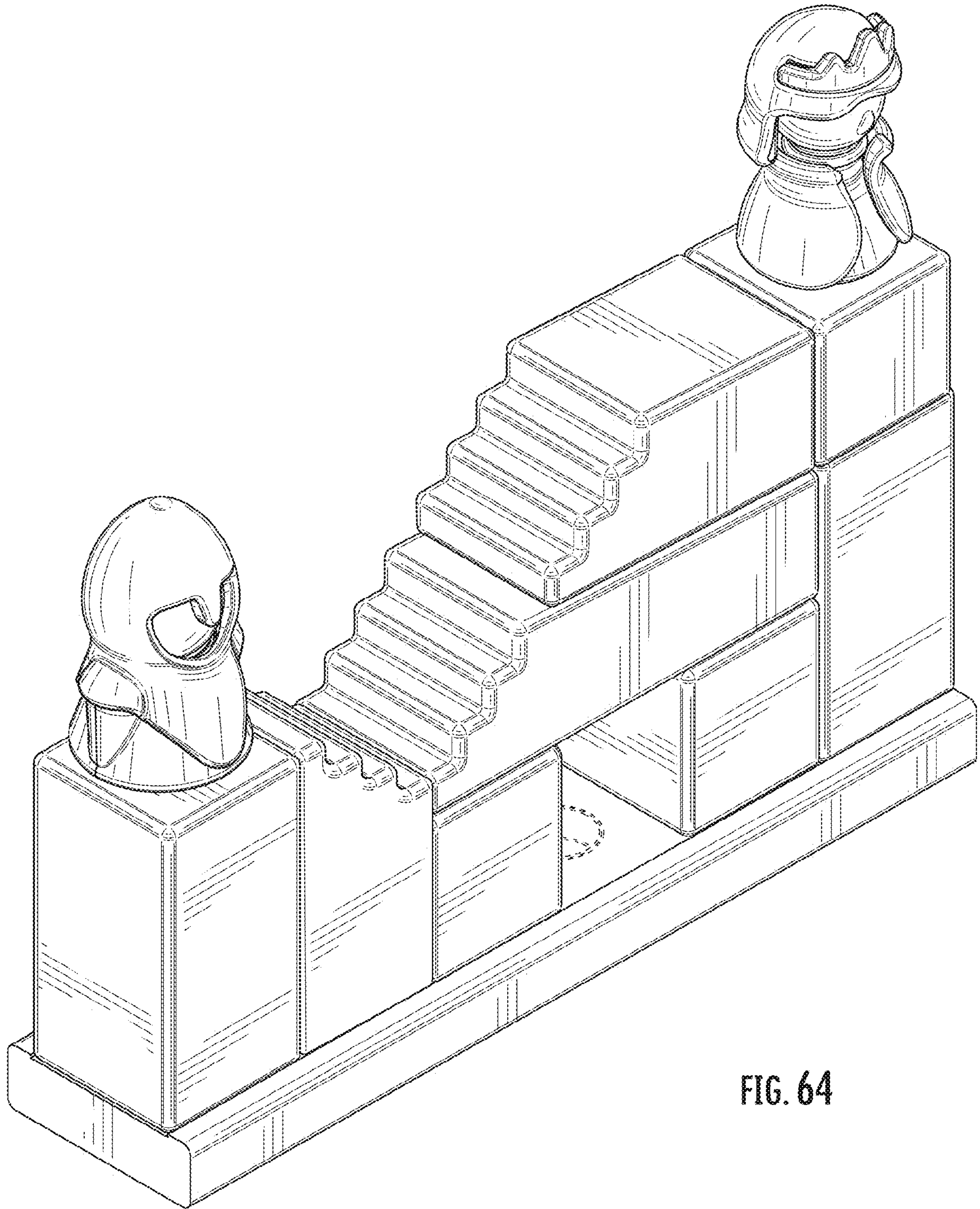

FIG. 64