



US00D941787S

(12) **United States Design Patent**
Malik et al.

(10) **Patent No.:** **US D941,787 S**
(45) **Date of Patent:** **** Jan. 25, 2022**

- (54) **SUBSTRATE TRANSFER BLADE**
- (71) Applicant: **Applied Materials, Inc.**, Santa Clara, CA (US)
- (72) Inventors: **Sultan Malik**, Sacramento, CA (US); **Srinivas D. Nemani**, Sunnyvale, CA (US); **Adib M. Khan**, Santa Clara, CA (US); **Qiwei Liang**, Fremont, CA (US)
- (73) Assignee: **Applied Materials, Inc.**, Santa Clara, CA (US)

(**) Term: **15 Years**

(21) Appl. No.: **29/726,488**

(22) Filed: **Mar. 3, 2020**

(51) **LOC (13) Cl.** **13-03**

(52) **U.S. Cl.**
USPC **D13/182**

(58) **Field of Classification Search**
USPC D13/118, 122, 133, 162, 182, 184, 199; D24/232
CPC C23C 16/455; C23C 16/45502; C23C 16/45517; C23C 16/4582; C23C 16/4583; C23C 16/4584; C23C 16/4585; C23C 16/4401; C23C 16/4402; C23C 16/4409; C23C 16/00; H01L 21/50; H01L 21/4817; H01L 21/4871; H01L 21/563; H01L 21/683; H01L 23/02; H01L 23/04; H01L 23/12; H01L 23/13; H01L 23/14; H01L 23/06; H01L 23/10; H01L 23/42; H05K 3/30; H01R 13/20; H01R 13/56; H01R 35/00

See application file for complete search history.

(56) **References Cited**

U.S. PATENT DOCUMENTS

- D810,705 S * 2/2018 Krishnan D13/182
- D819,580 S * 6/2018 Krishnan D13/182
- D842,259 S * 3/2019 Shono D13/182

- 10,347,475 B2 * 7/2019 Scheible H01L 21/68735
- D891,382 S * 7/2020 Koppa D13/182
- D904,640 S * 12/2020 Ruhland D24/225
- D934,315 S * 10/2021 Lavitsky D15/138
- 2008/0178801 A1 * 7/2008 Pavloff H01J 37/32633
118/504
- 2012/0263569 A1 * 10/2012 Priddy C30B 23/02
414/800
- 2017/0009367 A1 * 1/2017 Harris C25D 17/06
- 2017/0088949 A1 3/2017 Babayan et al.
- 2017/0287752 A1 10/2017 Godet et al.

(Continued)

FOREIGN PATENT DOCUMENTS

JP 2017101318 A 6/2017

Primary Examiner — Darlington Ly

(74) *Attorney, Agent, or Firm* — Patterson + Sheridan, LLP

(57) **CLAIM**

The ornamental design for a substrate transfer blade, as shown and described.

DESCRIPTION

FIG. 1 is a top perspective view of a substrate transfer blade embodying our new design;
 FIG. 2 is a bottom perspective view thereof;
 FIG. 3 is a top plan view thereof;
 FIG. 4 is a bottom plan view thereof;
 FIG. 5 is a right side elevation view thereof;
 FIG. 6 is a left side elevation view thereof;
 FIG. 7 is a front elevation view thereof;
 FIG. 8 is a rear elevation view thereof;
 FIG. 9 is a cross-sectional view thereof taken along line 9-9 in FIG. 4; and,
 FIG. 10 is an enlargement view thereof for the portion referenced in FIG. 9.
 The broken lines in the drawings illustrate portions of the substrate transfer blade that form no part of the claimed design.

1 Claim, 6 Drawing Sheets

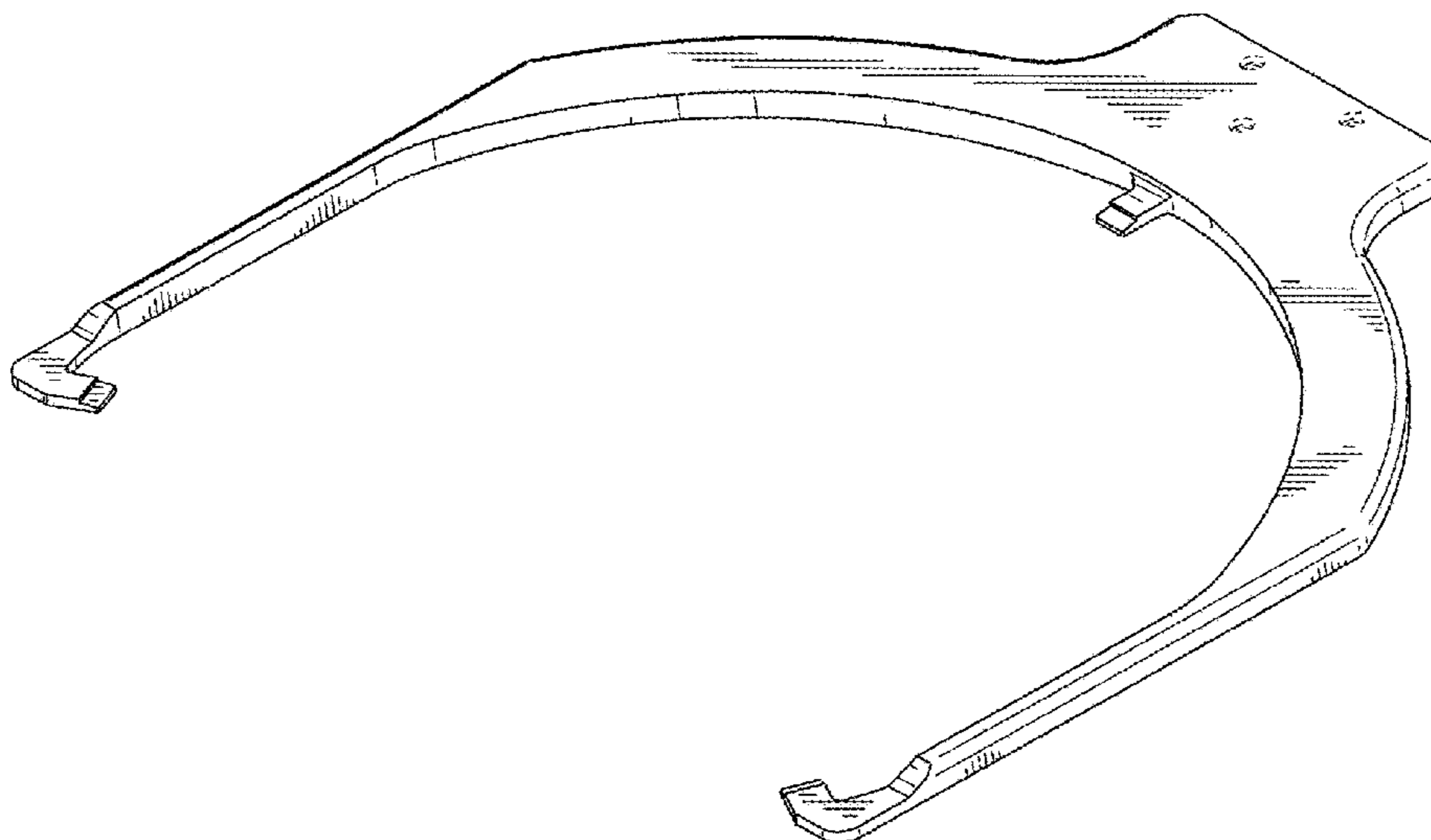

(56)

References Cited

U.S. PATENT DOCUMENTS

2018/0261480 A1 9/2018 Liang et al.
2019/0096638 A1* 3/2019 Lavitsky H01J 37/32513

* cited by examiner

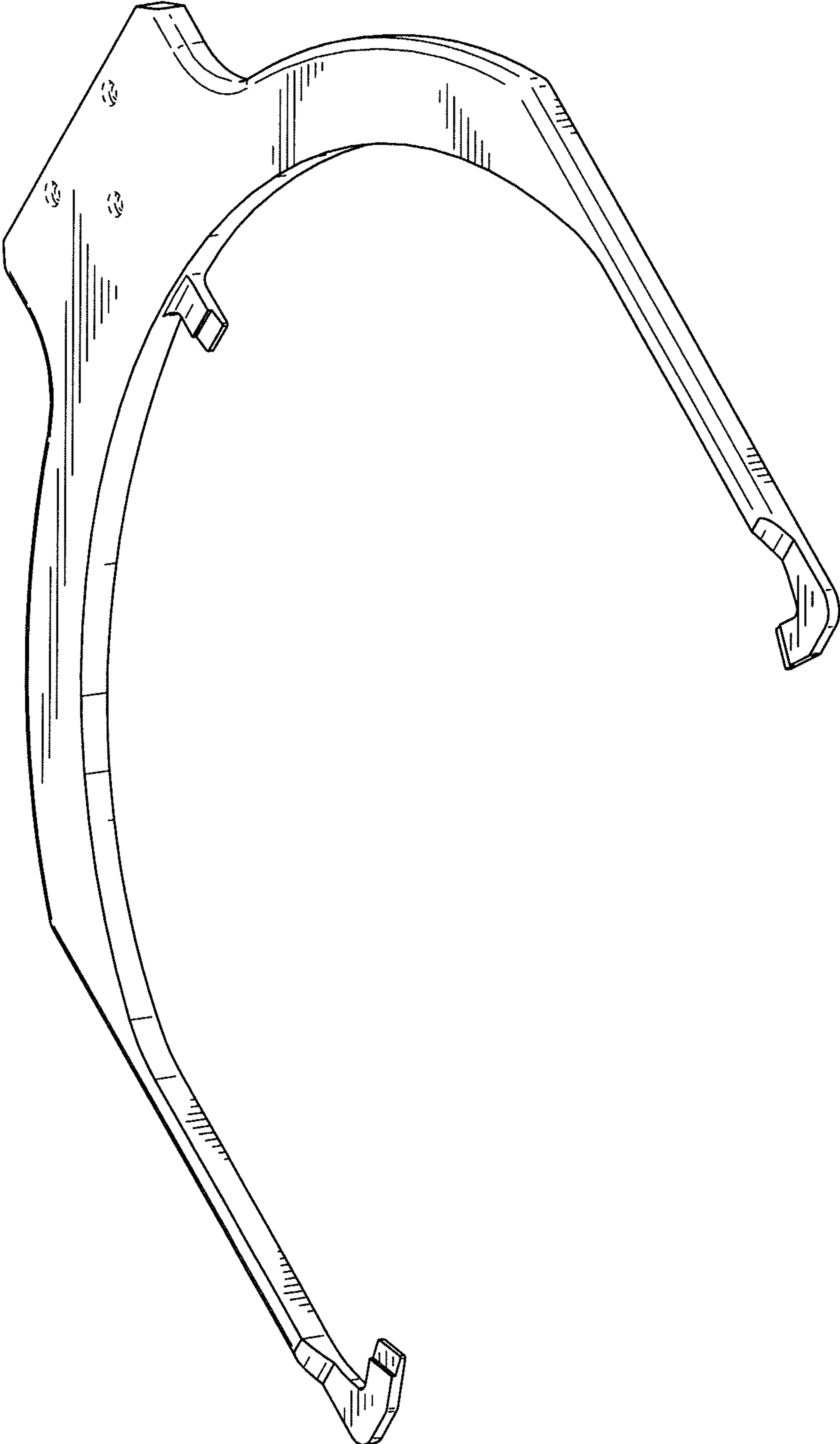

FIG. 1

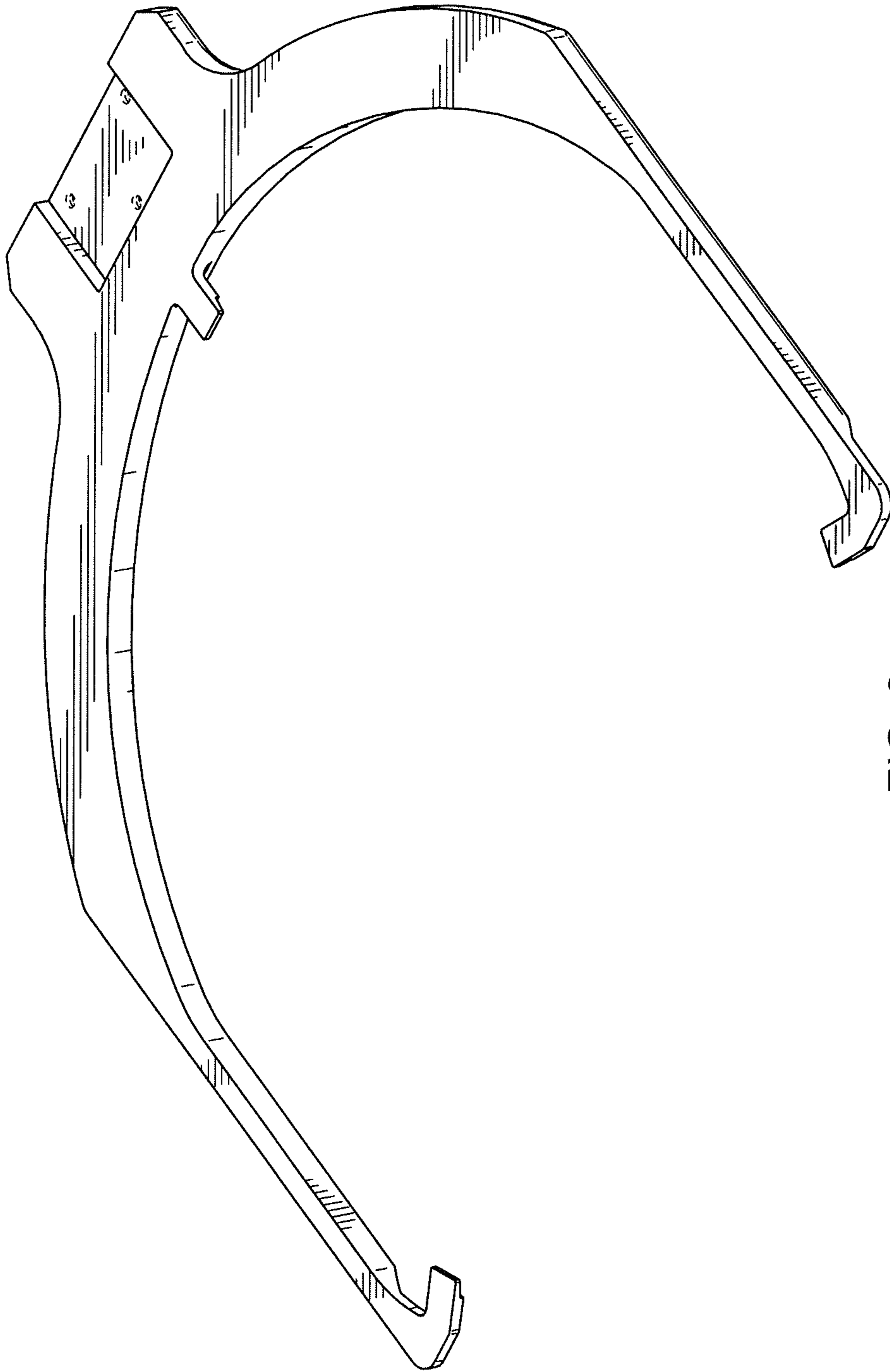

FIG. 2

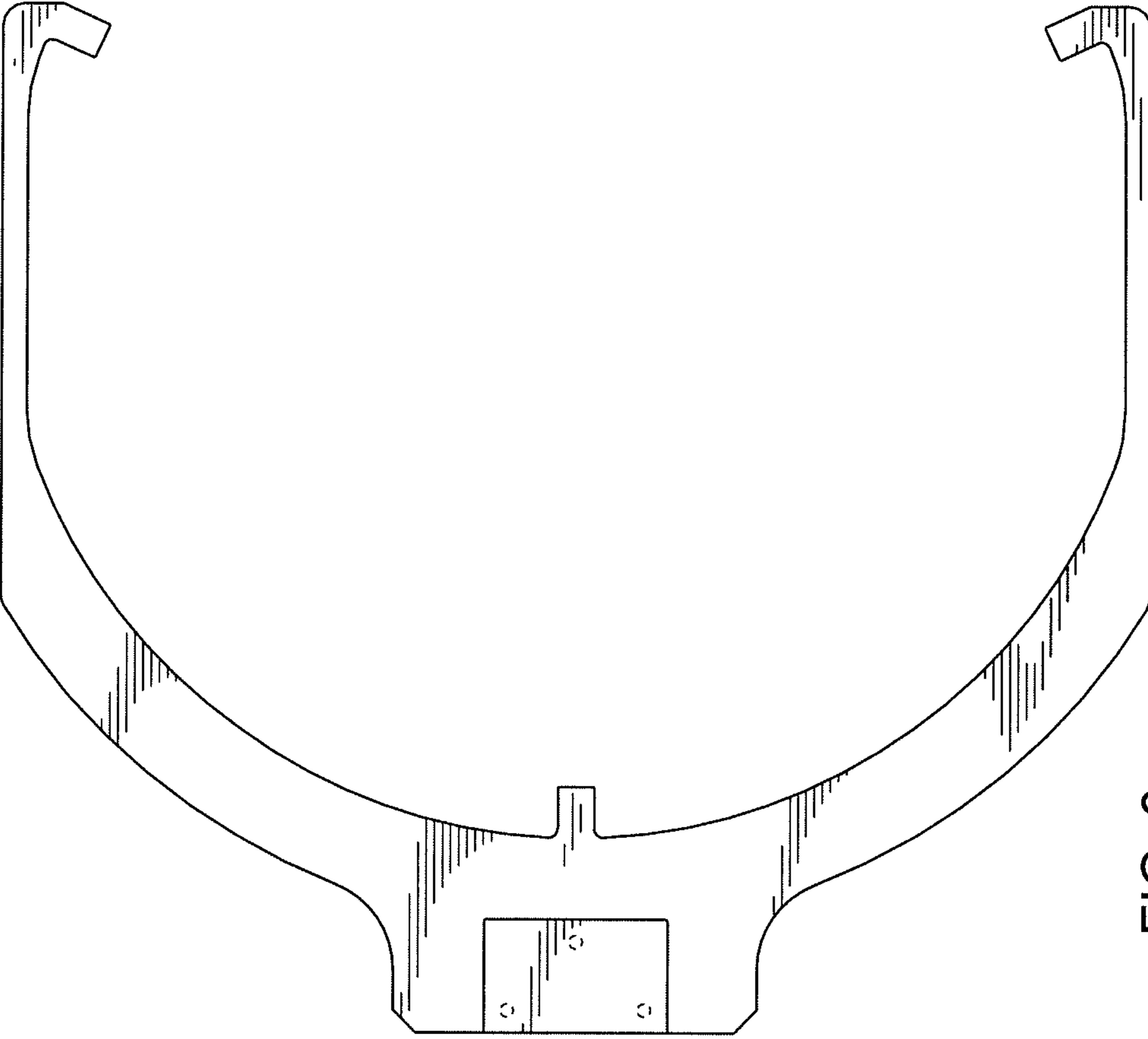

FIG. 3

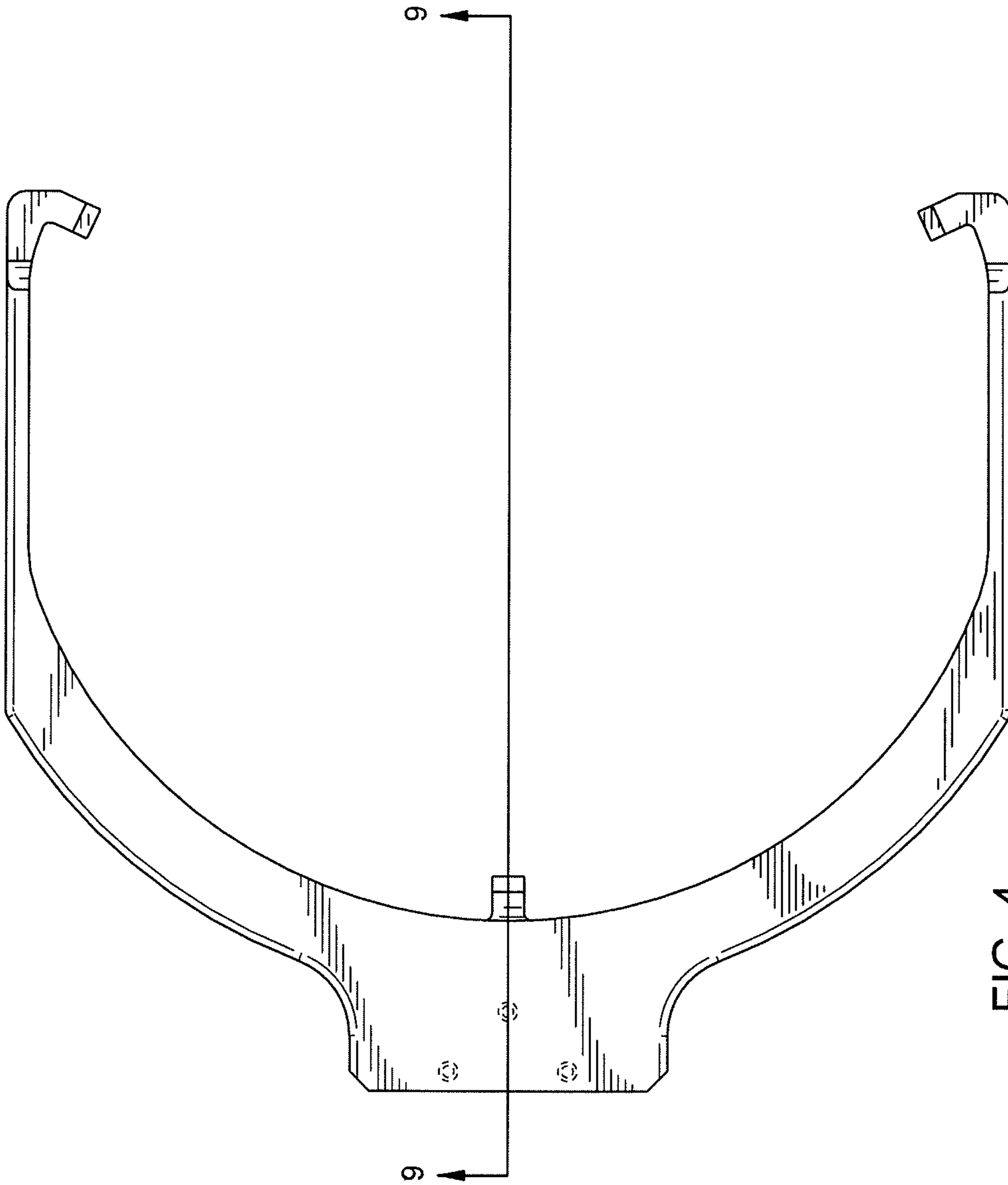

FIG. 4



FIG. 5



FIG. 6



FIG. 7

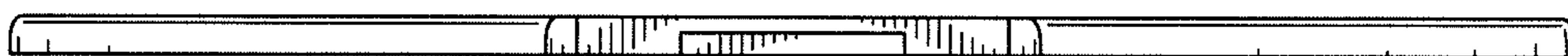

FIG. 8

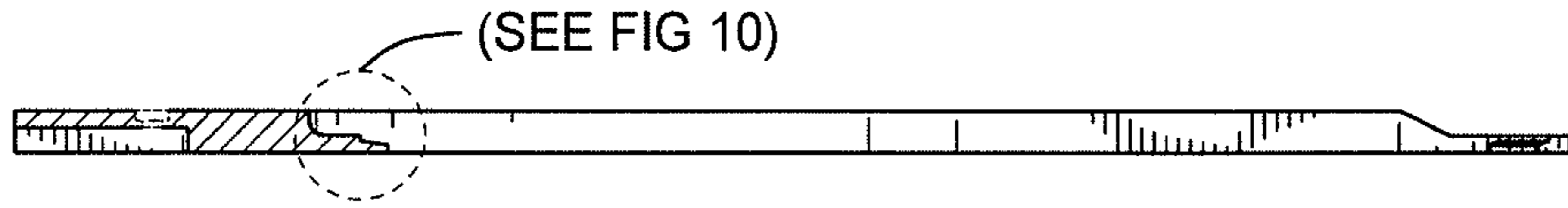

FIG. 9

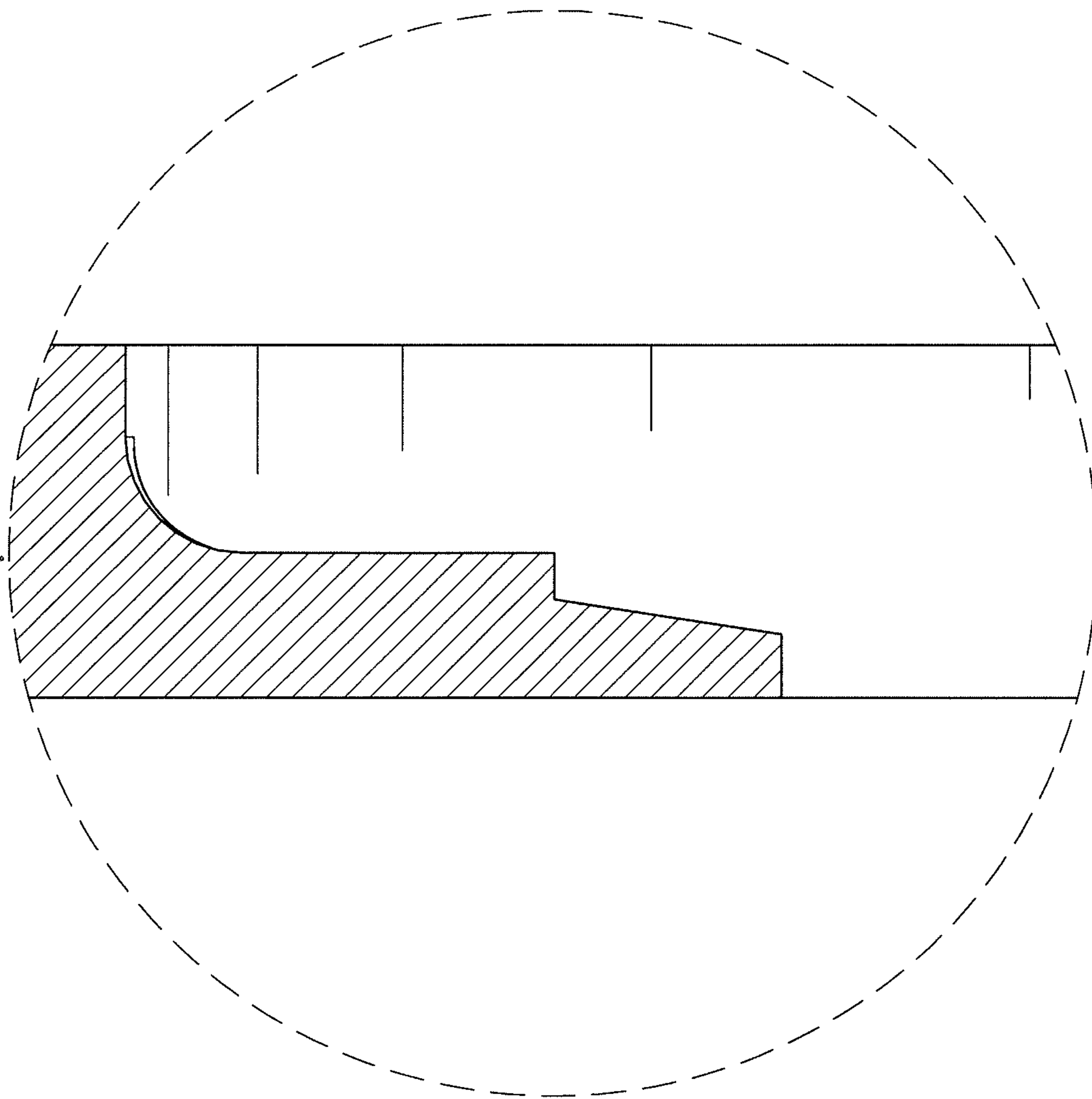

FIG. 10