



US00D941686S

(12) **United States Design Patent**
Holloway

(10) **Patent No.:** **US D941,686 S**
(45) **Date of Patent:** **** Jan. 25, 2022**

(54) **CALIBRATION BLOCK**
(71) Applicant: **HOLLOWAY NDT & ENGINEERING INC.**, Georgetown (CA)
(72) Inventor: **Paul Holloway**, Georgetown (CA)
(73) Assignee: **HOLLOWAY NDT & ENGINEERING INC.**, Georgetown (CA)

D462,018 S * 8/2002 Markle D10/64
D462,282 S * 9/2002 Salvagno G01B 3/30
D10/65
D528,931 S * 9/2006 Serpa E04F 21/0007
D10/65
D692,785 S * 11/2013 Pirayesh G01B 3/30
D10/71
9,097,506 B2 * 8/2015 Shapiro G01B 3/04
9,958,248 B2 * 5/2018 Laemmer G01B 3/30
D879,167 S * 3/2020 Winans D15/130
2015/0168120 A1 * 6/2015 Cupertino G01B 3/30
33/194

(**) Term: **15 Years**

* cited by examiner

(21) Appl. No.: **29/715,769**

Primary Examiner — Antoine Duval Davis

(22) Filed: **Dec. 4, 2019**

(74) *Attorney, Agent, or Firm* — Nathan V. Woodruff

Related U.S. Application Data

(62) Division of application No. 29/668,083, filed on Oct. 26, 2018, now Pat. No. Des. 881,728.

Foreign Application Priority Data

Jul. 27, 2018 (CA) CA 182777

(51) **LOC (13) Cl.** **10-04**

(52) **U.S. Cl.**
USPC **D10/65**

(58) **Field of Classification Search**
USPC D10/65
CPC G01B 3/30; G01B 3/34
See application file for complete search history.

References Cited

U.S. PATENT DOCUMENTS

3,908,278 A * 9/1975 Sundahl G01B 3/30
33/502
D331,025 S * 11/1992 Friddell D10/65

CLAIM

I claim the ornamental design for a calibration block, as shown and described.

DESCRIPTION

FIG. 1 is a left side elevation view of the calibration block; FIG. 2 is a right side elevation view thereof; FIG. 3 is a front elevation view thereof; FIG. 4 is a rear elevation view thereof; FIG. 5 is a top plan view thereof; FIG. 6 is a bottom plan view thereof; FIG. 7 is a front perspective view thereof; and, FIG. 8 is a side perspective view thereof.

1 Claim, 3 Drawing Sheets

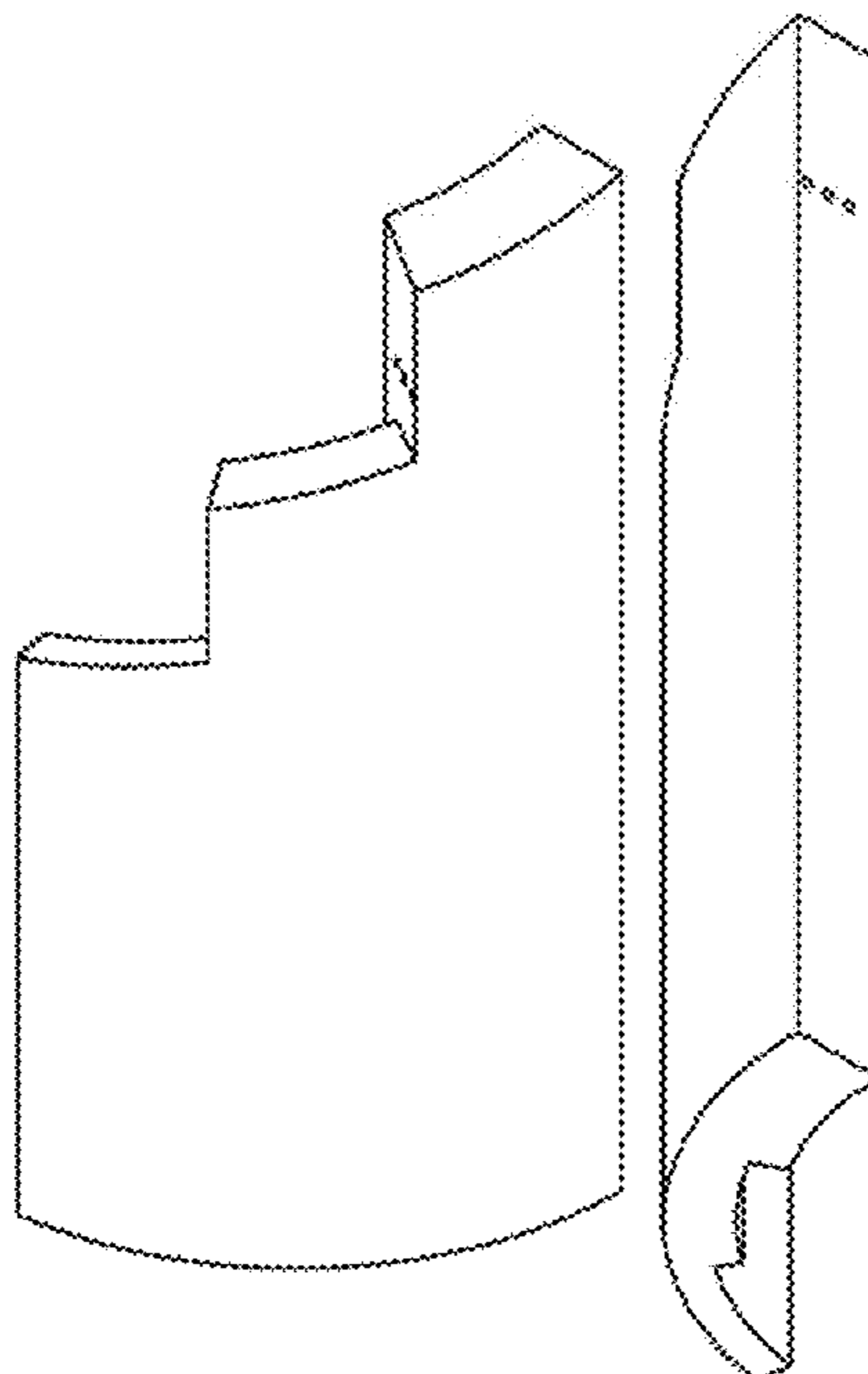

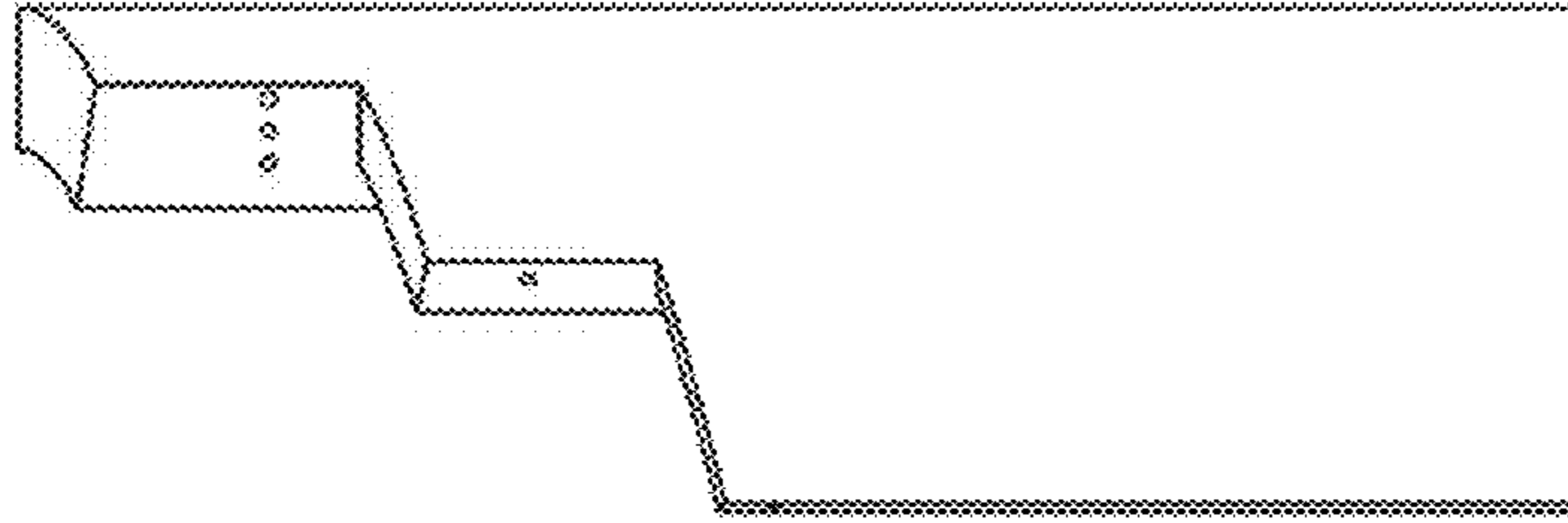

FIG. 1

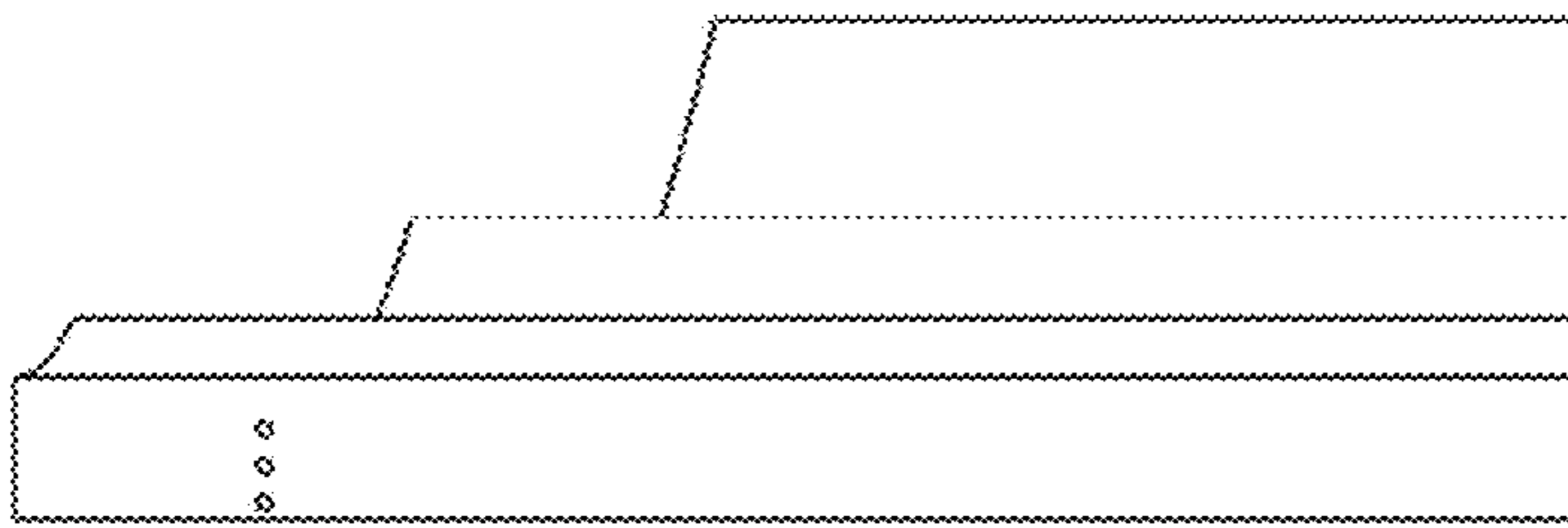

FIG. 2

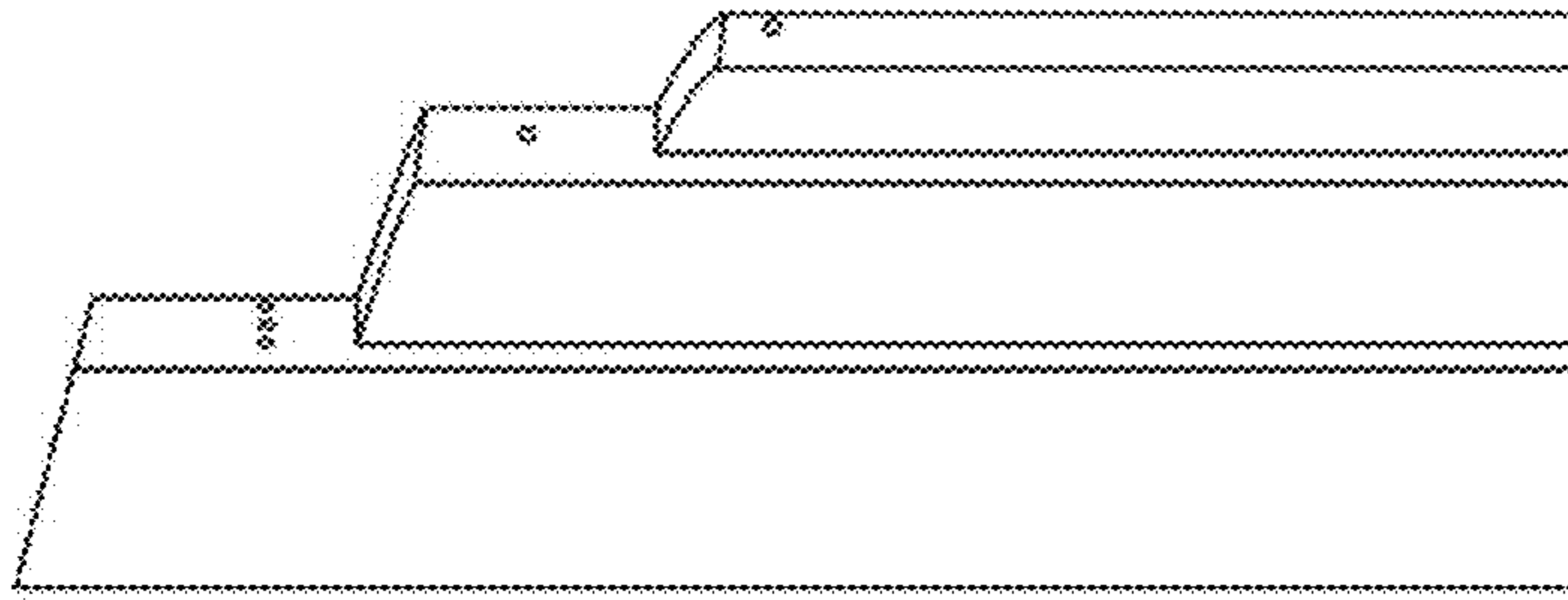

FIG. 4

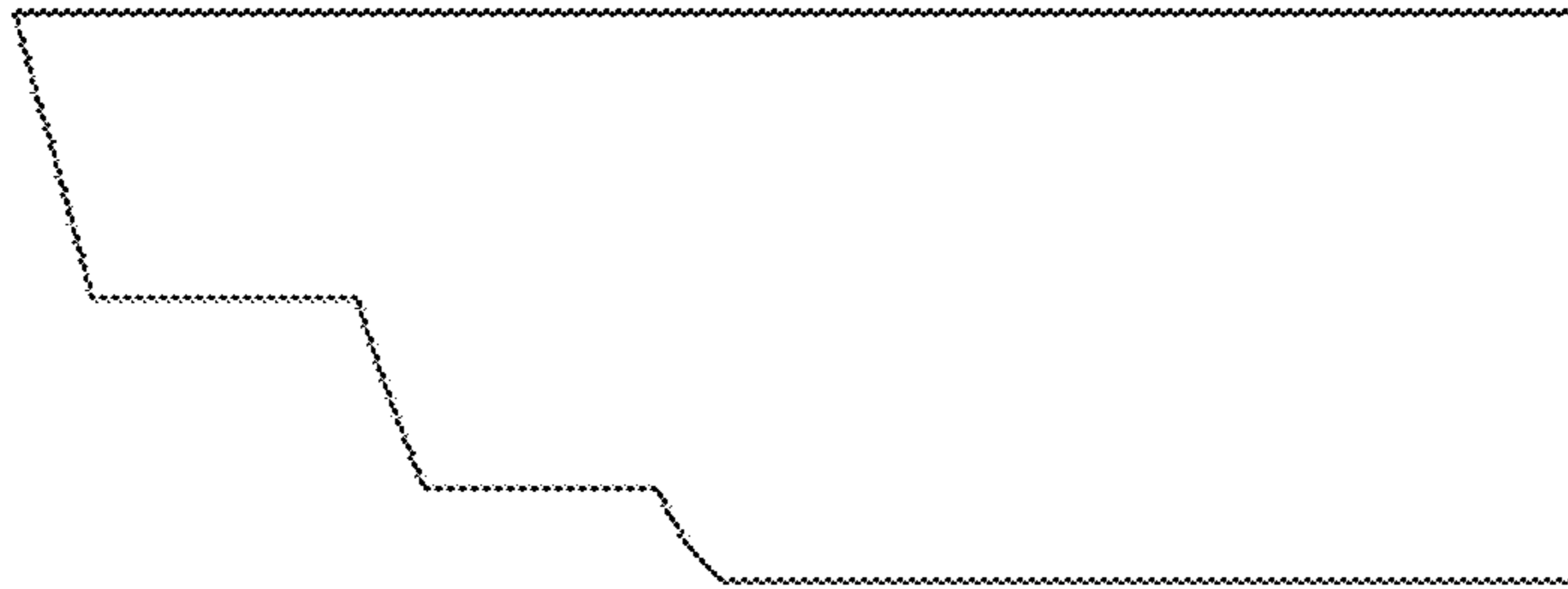

FIG. 3

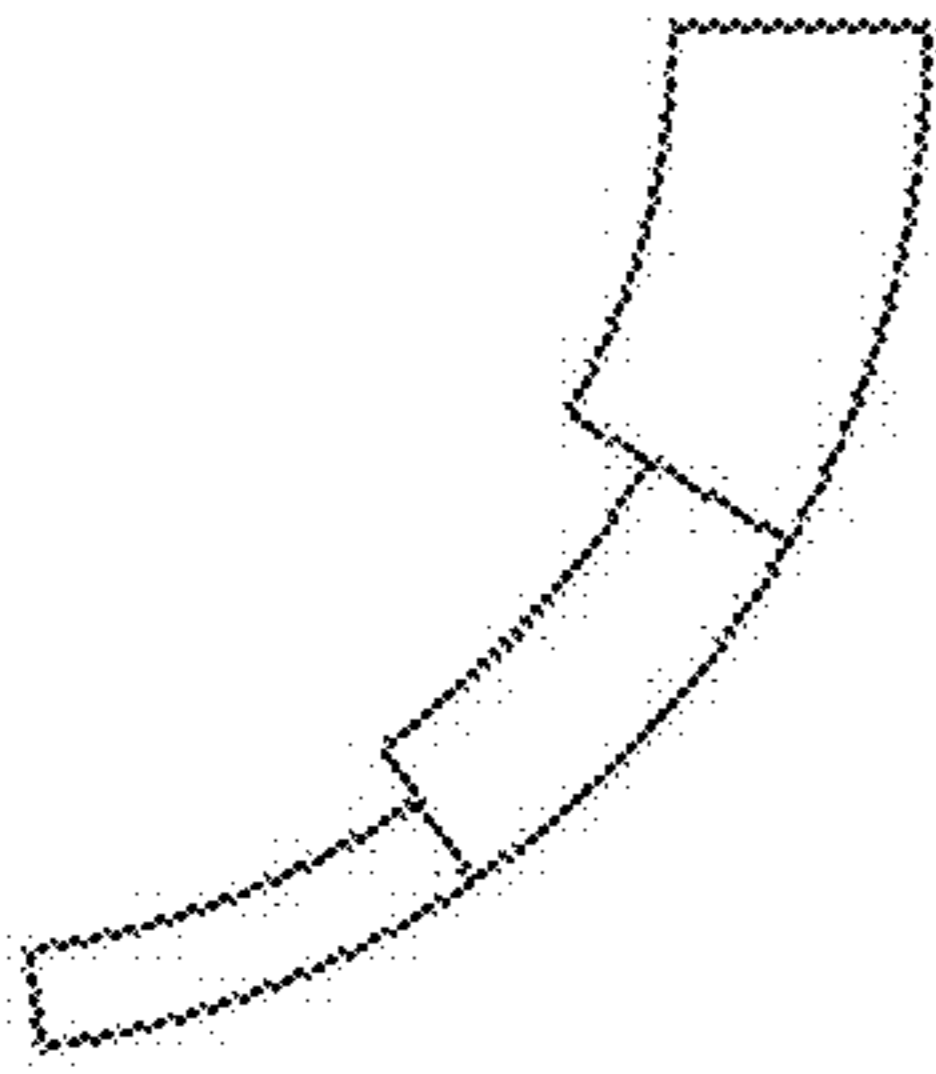

FIG. 5

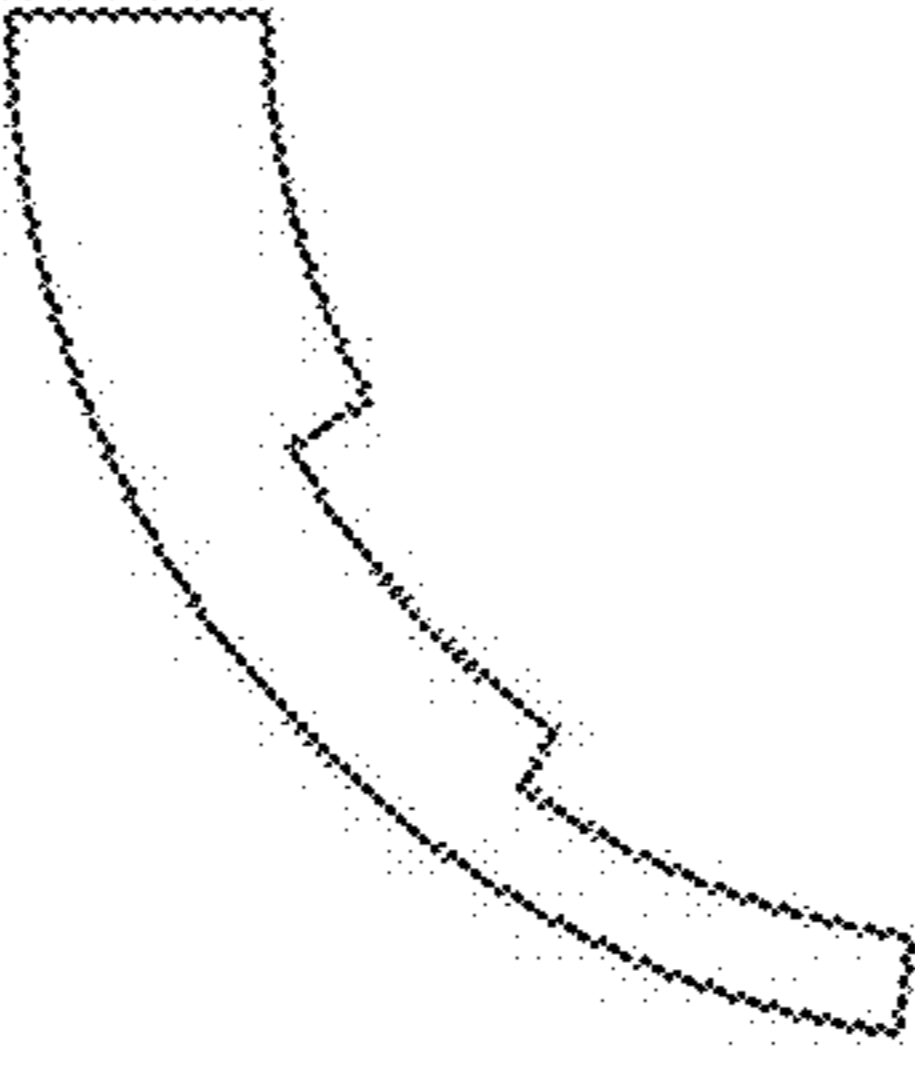

FIG. 6

FIG. 7

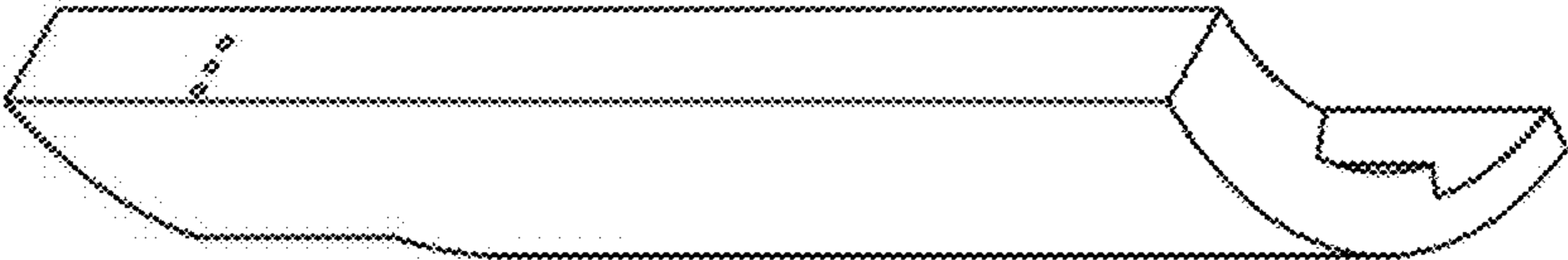
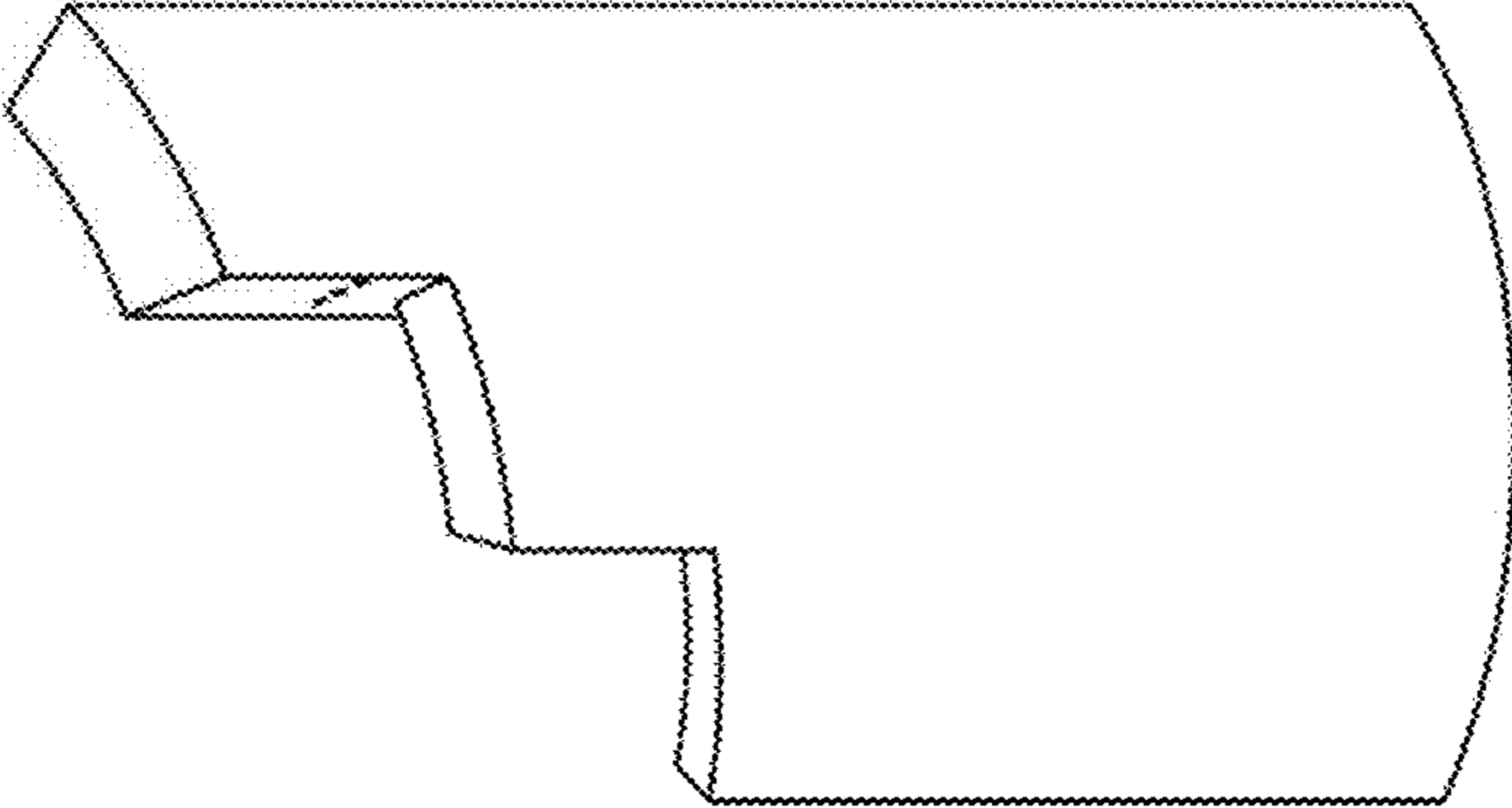

FIG. 8