



US00D941619S

(12) **United States Design Patent** (10) **Patent No.:** **US D941,619 S**
Davis et al. (45) **Date of Patent:** **** *Jan. 25, 2022**

(54) **HALL TREE**

(71) Applicant: **WALKER EDISON FURNITURE COMPANY LLC**, Salt Lake City, UT (US)

(72) Inventors: **Matthew Davis**, Murray, UT (US);
Brad Bonham, Draper, UT (US);
Richard A. Packer, Kaysville, UT (US)

(73) Assignee: **Walker Edison Furniture Company LLC**, West Jordan, UT (US)

(*) Notice: This patent is subject to a terminal disclaimer.

(**) Term: **15 Years**

(21) Appl. No.: **29/694,776**

(22) Filed: **Jun. 13, 2019**

Related U.S. Application Data

(63) Continuation of application No. 29/677,745, filed on Jan. 23, 2019, now Pat. No. Des. 923,370.

(51) **LOC (13) Cl.** **20-02**

(52) **U.S. Cl.**
USPC **D6/675.3**

(58) **Field of Classification Search**
USPC D6/552, 672, 675, 675.1, 675.2, 675.3, D6/675.4, 675.5, 335, 343, 396, 397, 657, D6/661, 663, 664, 670, 673, 680.2, 680.3, D6/681, 681.1, 681.2, 682, 682.4, 699.1, D6/702

(Continued)

(56) **References Cited**

U.S. PATENT DOCUMENTS

D49,624 S 9/1916 Rought et al.
1,687,613 A 10/1928 Hernacki

(Continued)

OTHER PUBLICATIONS

Woven Paths Modern Hall Tree, Published date unavailable [online], [retrieved on Jul. 12, 2021], Retrieved from the Internet: <https://www.walmart.com/ip/Woven-Paths-Modern-Hall-Tree-with-Bench-and-5-Shelves-Reclaimed-Barnwood/898291272> (Year: 2021).*

(Continued)

Primary Examiner — Christian P. McLean

Assistant Examiner — Adam C Mager

(74) *Attorney, Agent, or Firm* — Workman Nydegger

(57) **CLAIM**

The ornamental design for a hall tree, as shown and described.

DESCRIPTION

FIG. 1 is a front perspective view of a first embodiment of a hall tree showing the new design;
FIG. 2 is a front elevation view thereof;
FIG. 3 is a back elevation view thereof;
FIG. 4 is a top plan view thereof;
FIG. 5 is a bottom plan view thereof;
FIG. 6 is a right elevation view thereof;
FIG. 7 is a left elevation view thereof;
FIG. 8 is another front perspective view of a second embodiment of a hall tree showing the new design;
FIG. 9 is a front elevation view thereof;
FIG. 10 is a back elevation view thereof;
FIG. 11 is a top plan view thereof;
FIG. 12 is a bottom plan view thereof;
FIG. 13 is a right elevation view thereof; and,
FIG. 14 is a left elevation view thereof.

The broken lines in the drawings are for the purpose of illustrating portions of the hall tree that form no part of the claimed design.

1 Claim, 8 Drawing Sheets

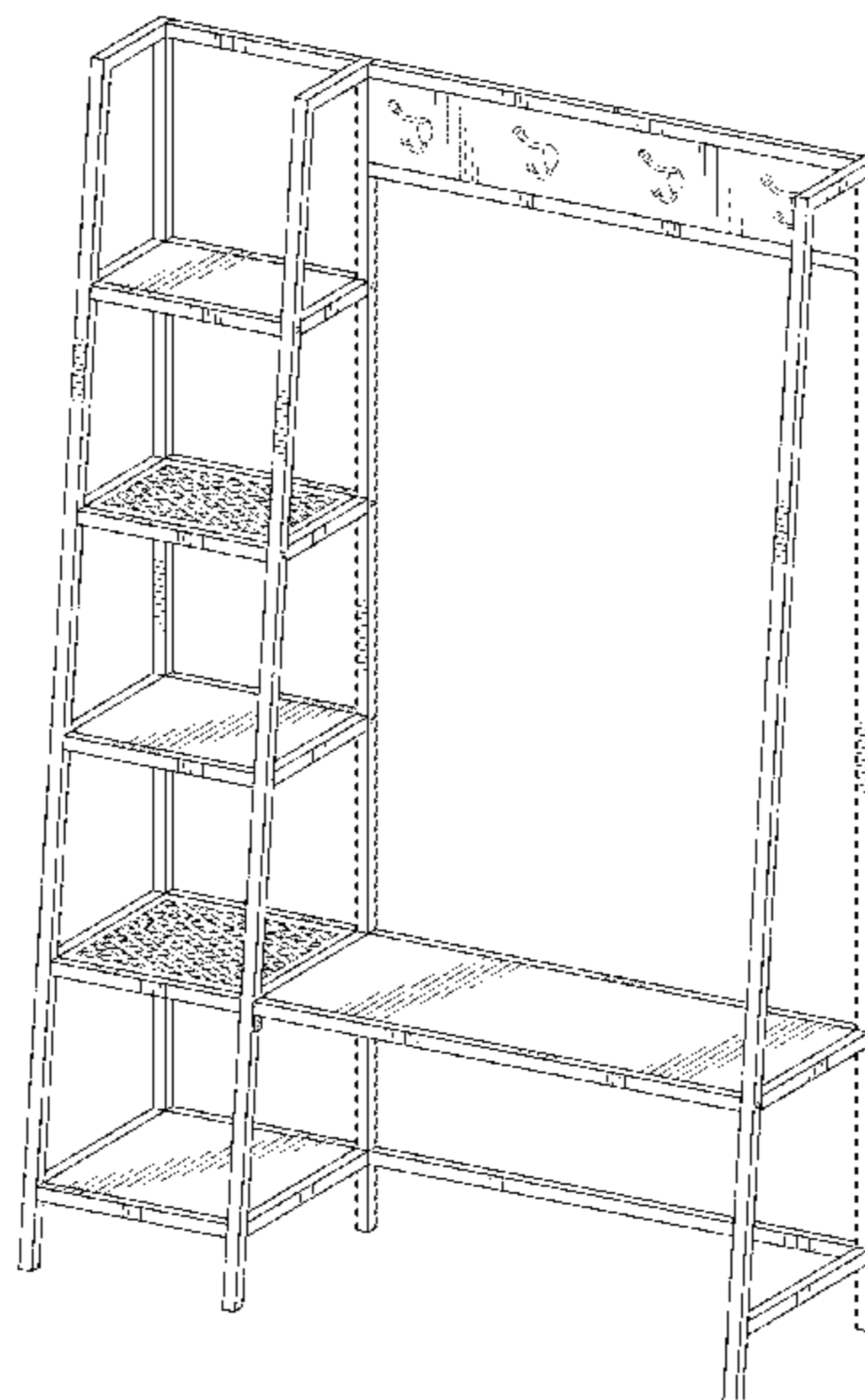

(58) **Field of Classification Search**
 CPC A47B 47/00; A47B 47/02; A47B 47/04;
 A47B 47/021; A47B 57/00; A47B
 57/406; A47B 96/00; A47B 96/02; A47B
 61/04; A47F 1/00; A47F 7/24
 See application file for complete search history.

(56) **References Cited**
 U.S. PATENT DOCUMENTS

1,776,471	A	9/1930	Kelly	
2,614,702	A	10/1952	Riblet	
3,045,831	A	7/1962	Pendergrast	
D205,666	S	9/1966	Magnuson	
D213,809	S	4/1969	Redman	
D216,380	S	12/1969	Redman	
3,565,020	A	10/1971	Schier	
D235,296	S	6/1975	Ginat	
D237,231	S	10/1975	Wells et al.	
D237,931	S	12/1975	Bradenfels	
D244,913	S	7/1977	Bradenfels	
D247,592	S	3/1978	Eisen	
D248,915	S	8/1978	Bradenfels	
D249,618	S	9/1978	Oxenhandler	
D255,189	S	6/1980	Zapf	
D259,007	S	4/1981	Schuckenbrock	
4,905,609	A	3/1990	Haskins	
D311,099	S	10/1990	Yau Kee	
D319,156	S	8/1991	Cugley	
5,240,127	A	8/1993	Levin	
D345,454	S	3/1994	Hauglin	
D363,623	S	10/1995	Rushing	
D363,834	S	11/1995	Thompson	
D369,035	S	4/1996	Potter	
D372,105	S	7/1996	Plotner	
D382,513	S	8/1997	Bozzone	
D391,421	S	3/1998	Steelman	
D400,375	S	11/1998	Peng-Hui	
D415,365	S	10/1999	Nicklas	
D436,263	S	1/2001	Alcala	
D491,749	S	6/2004	Malizia	
D492,861	S	7/2004	Lenger	
D498,962	S	11/2004	Moon	
D505,274	S	5/2005	Lai	
D512,585	S	12/2005	Rozenboom	
D527,208	S	8/2006	Malizia	
D541,557	S	5/2007	Weatherly	
D560,933	S	2/2008	Sexton	
D582,188	S	12/2008	Martin	
D591,086	S *	4/2009	Karsson	D6/675.3
D591,533	S *	5/2009	Karsson	D6/675.3
7,641,294	B1	1/2010	Goldberg	
D609,501	S	2/2010	Sexton	
D613,967	S	4/2010	Sexton	
D614,421	S	4/2010	Sexton	
D614,888	S	5/2010	Sexton	
D620,729	S	8/2010	Snider	
D624,200	S	9/2010	Kieffer	
D632,900	S	2/2011	Goldberg	
D643,232	S	8/2011	Wagner	
D653,475	S	2/2012	Thompson	
D660,614	S	5/2012	Palmeiri	
D664,731	S	7/2012	Martin	
D679,115	S	4/2013	Chavez	
D685,851	S	7/2013	Offenkrantz	
D716,080	S	10/2014	Bell	
D735,412	S	7/2015	Coleman	
D747,124	S	1/2016	O'Donnell	
9,332,838	B1	5/2016	Kilday	
D760,516	S	7/2016	Yu	
D779,240	S	2/2017	Tio	
D784,738	S	4/2017	Wang	
D785,981	S	5/2017	Kimmich	
D805,329	S	12/2017	Rockwell	
D808,200	S	1/2018	Davis	
D808,203	S *	1/2018	Davis	D6/675.3
D817,039	S	5/2018	Adolph	

D819,374	S	6/2018	Kuehn	
D829,473	S	10/2018	Mical	
D852,555	S	7/2019	Fenneman	
D853,762	S	7/2019	Tucker	
D860,689	S *	9/2019	Davis	D6/672
D864,625	S	10/2019	Rockwell	
D864,627	S	10/2019	Rockwell	
D871,116	S *	12/2019	Li	D6/675.1
D874,191	S	2/2020	Qi	
D878,115	S	3/2020	Rau	
D883,719	S	5/2020	Li	
D885,806	S	6/2020	Rockwell	
10,689,793	B2	6/2020	Glass	
D923,370	S *	6/2021	Davis	D6/675.3

OTHER PUBLICATIONS

Potterybarn.com; Declan Entry Hall Tree, Burnished Pine; potterybarn.com/products/declan-entry-hall-tree/?isx=0.2 ; site visited Jun. 12, 2019.

U.S. Appl. No. 29/656,483, filed Jul. 12, 2018, Davis.

U.S. Appl. No. 29/656,495, filed Jul. 12, 2018, Davis.

U.S. Appl. No. 29/677,745, filed Jan. 23, 2019, Davis.

U.S. Appl. No. 29/677,750, filed Jan. 23, 2019, Davis.

Jossandmain.com; Hall trees, site visited Apr. 23, 2019 <https://www.jossandmain.com/furniture/pdp/savarese-hall-tree-qpv8639.html?refid=SBP.rBAZI1bbsDRuWni7P5NMAIhHWtn0UPzia1pwEIXrII>.

Wayfair.com; Faulk Desk with Hutch, site visited Apr. 24, 2019, <https://www.wayfair.com/furniture/pdp/wrought-studio-faulk-desk-with-hutch-vark6889.html?piid=&experientype=1>.

Wayfair.com; Cecil Solid Wood Leaning/Ladder Desk, site visited Apr. 24, 2019; <https://www.wayfair.com/furniture/pdp/17-stories-cecil-leaningladder-desk-stss1472.html?piid=&experientype=1>.

Wayfair.com; Ladder Desk, site visited Apr. 24, 2019; <https://www.wayfair.com/furniture/pdp/monarch-specialties-inc-ladder-desk-mnq2850.html?&experientype=1>.

U.S. Appl. No. 29/656,495, filed Jun. 26, 2019, Notice of Allowance.

Wilmette Cherry Desk with Shelves, by Flash Furniture—The Classy Home <https://www.theclassyhonne.com/Product/FLF-NAN-JN-21711-GG/Flash+Furniture+Wilmette+Cherry+Desk+with-FShelves>; retrieved from the internet on May 17, 2020.

Mid Century Modular Elias Desk With Shelf—Cost Plus World Market <https://www.worldnmarket.com/product/nnid+century+nnodular+elias+desk+with+shelf.do?sortby=ourPicks&fronn=fn> retrieved from the internet on May 17, 2020.

DESIGNA Computer Desk with Bookshelf—Amazon.com https://www.amazon.com/dp/B081DXDXW1/ref=sspa_dk_detail_3?psc=1&pd_rd_i=B081DXD; retrieved from the internet on May 17, 2020.

U.S. Appl. No. 29/677,750, dated May 21, 2020, Office Action.

U.S. Appl. No. 29/677,745, dated Sep. 25, 2020, Office Action.

U.S. Appl. No. 29/699,086, dated Dec. 23, 2020, Notice of Allowance.

Walker Edison Solid Wood Angled Hall Tree, <https://www.totallyfurniture.com/68-solid-wood-angled-hall-tree-brown-walker-edison-ht68frabr> (Year: 2020).

Office Action for U.S. Appl. No. 29/699,086, dated Sep. 9, 2020.

Notice of Allowance for U.S. Appl. No. 29/656,483, dated Sep. 11, 2020.

Corrected Notice of Allowance for U.S. Appl. No. 29/656,483, dated Sep. 23, 2020.

Notice of Allowance for U.S. Appl. No. 29/677,750, dated Sep. 14, 2020.

Corrected Notice of Allowance for U.S. Appl. No. 29/677,750, dated Sep. 24, 2020.

ClosetMain 1316 4-Tier Wood Ladder Shelf Bookcase, <https://www.amazon.com/ClosetMaid-1316-4-Tier-Ladder-Bookcase/dp/B01N7S3EJS>, retrieved Jun. 3, 2021, available on information and believe as early as Jan. 13, 2017.

Winsome Wood 4-Tier A-Frame Shelf, <https://www.amazon.com/Winsome-Wood-4-Tier-Frame-Espresso/dp/B000NPQHGS>, retrieved Jun. 3, 2021, available on information and believe as early as Apr. 2004.

(56)

References Cited

OTHER PUBLICATIONS

Hampton Brown Hall Tree, https://www.homedepot.com/pep/Steve-Silver-Hampton-Brown-Hall-Tree-HT460HT/315643934?source=shoppingads&locale=en-US&mtc=Shopping-BA-F_HDH-G-D59-59_34_INTERIOR_FURNITURE-MULTI-NA-Feed-PLA-NA-NA-059_034_004_ENTRY_WAY_FURNITURE_Entryway&cm_mmc=Shopping-BA-F_HDH-G-D59-59_34_INTERIOR_FURNITURE-MULTI-NA-Feed-PLA-NA-NA-059_034_004_ENTRY_WAY_FURNITURE_Entryway-7170000048685355-58700004834194632-92700061185613476&gclid=CjwKCAjwJ2FBhAuEiwAIKu19q9q-jUYlu2R3ix428MUj0K7BnGf02MCZDpaqhw5_3gtEgaldx3zLRoC330QAvD_BwE&gclsrc=aw.ds, retrieved Jun. 3, 2021.

IRIS USA, Inc. PI-B3 IRIS Metal Garment Rack with Wood Shelves, <https://allindustrialdecor.com/product/iris-usa-inc-pi-b3-iris-metal-garment-rack-with-wood-shelves-black-dark-brown/>, retrieved Jun. 3, 2021, available on information and believe as early as Nov. 2017.

VASAGLE Hall Trees, 30", Rustic Brown, https://www.amazon.com/VASAGLE-Entryway-Clothing-Furniture-ULGR13BX/dp/B07FMSSFMV/ref=asc_df_B07FMSSFMV/?tag=hyprod-20&linkCode=dfo&hvadid=312216071718&hvpos=&hvnetw=g&hvrnd=12459760046387759801&hvpone=&hvptwo=&hvqmt=&hvdev=c&hvdvcmdl=&hvlocint=&hvlocphy=9029699&hvtargid=pla-649625440972&psc=1, retrieved Jun. 3, 2021, available on information and believe as early as Mar. 2018.

* cited by examiner

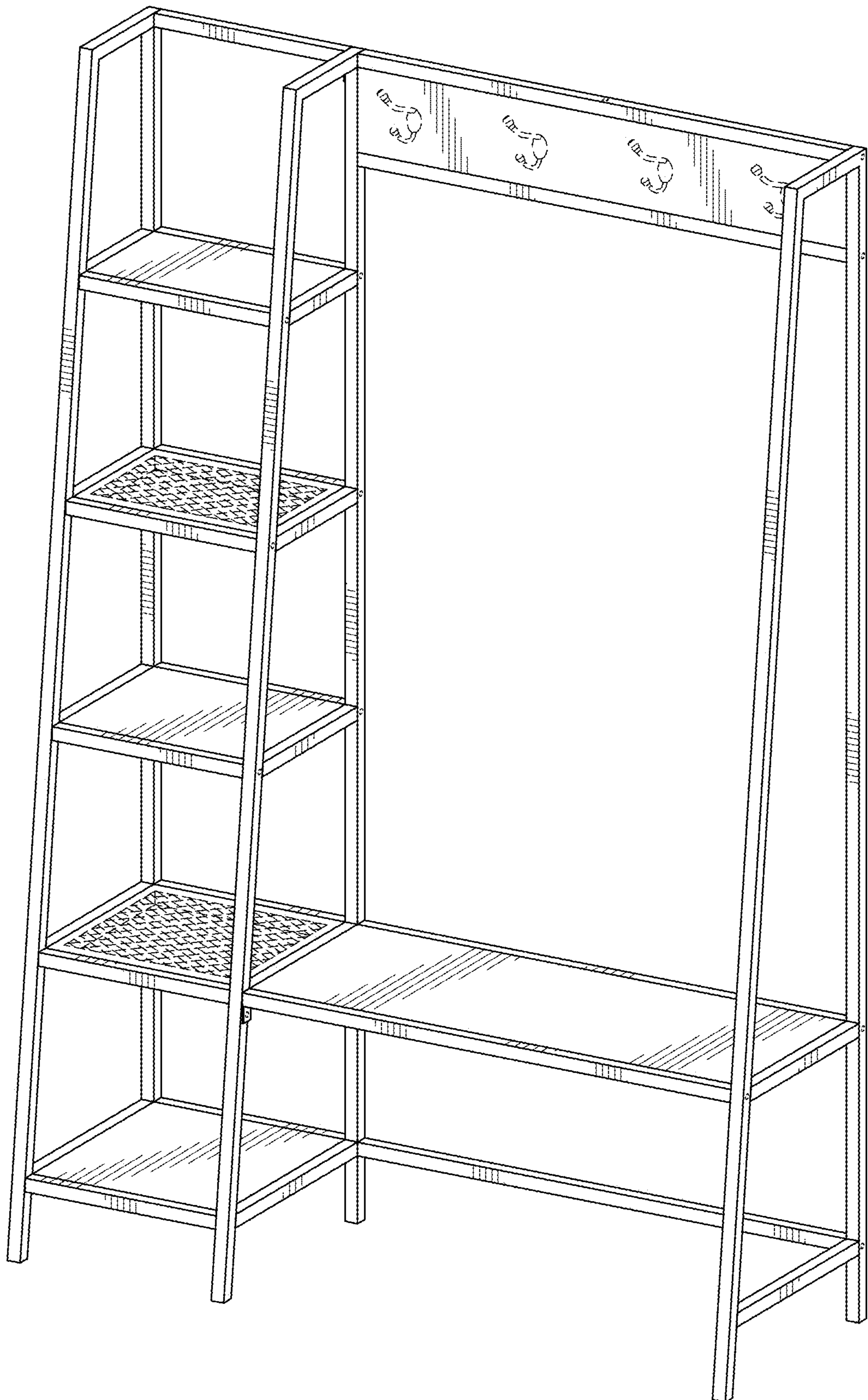

FIG. 1

FIG. 2

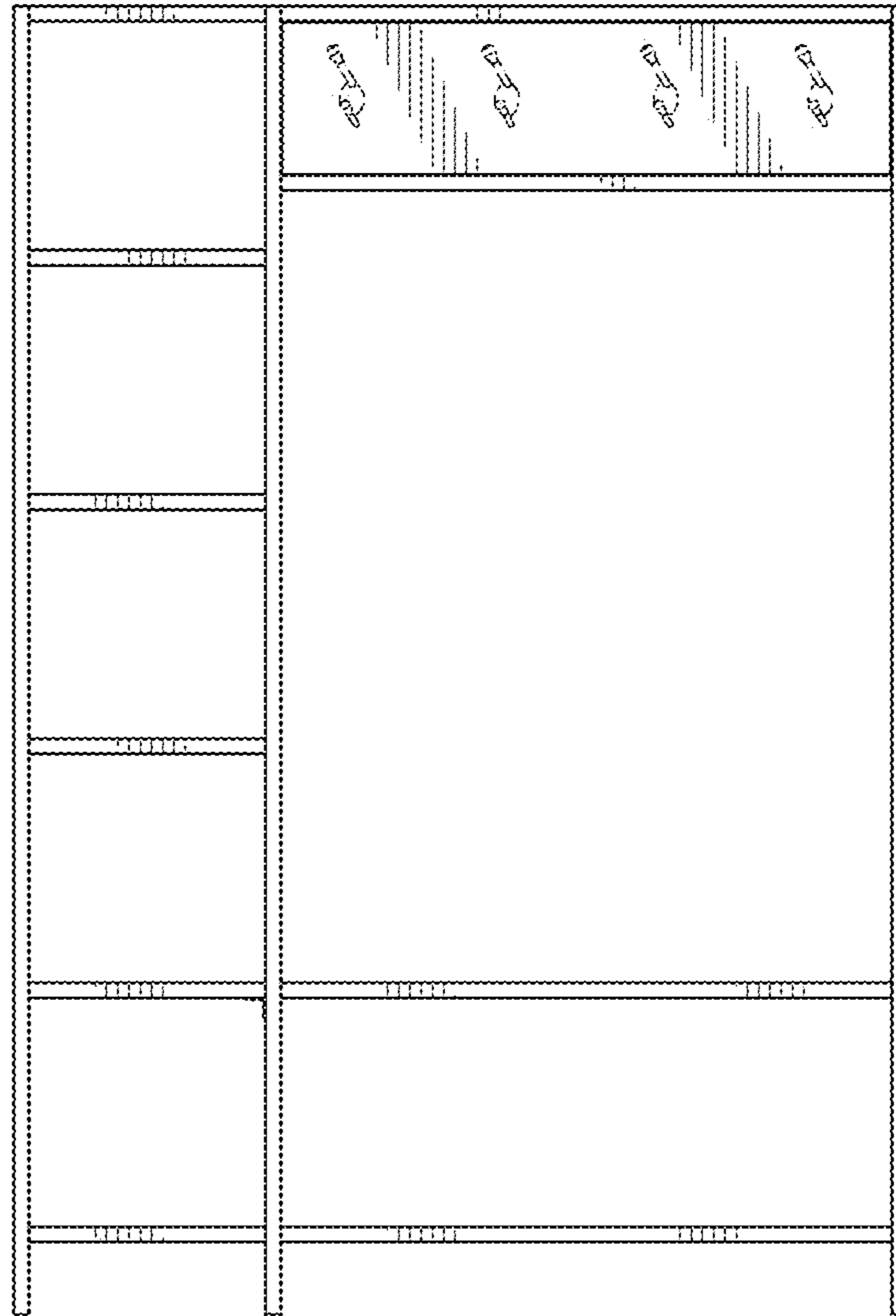
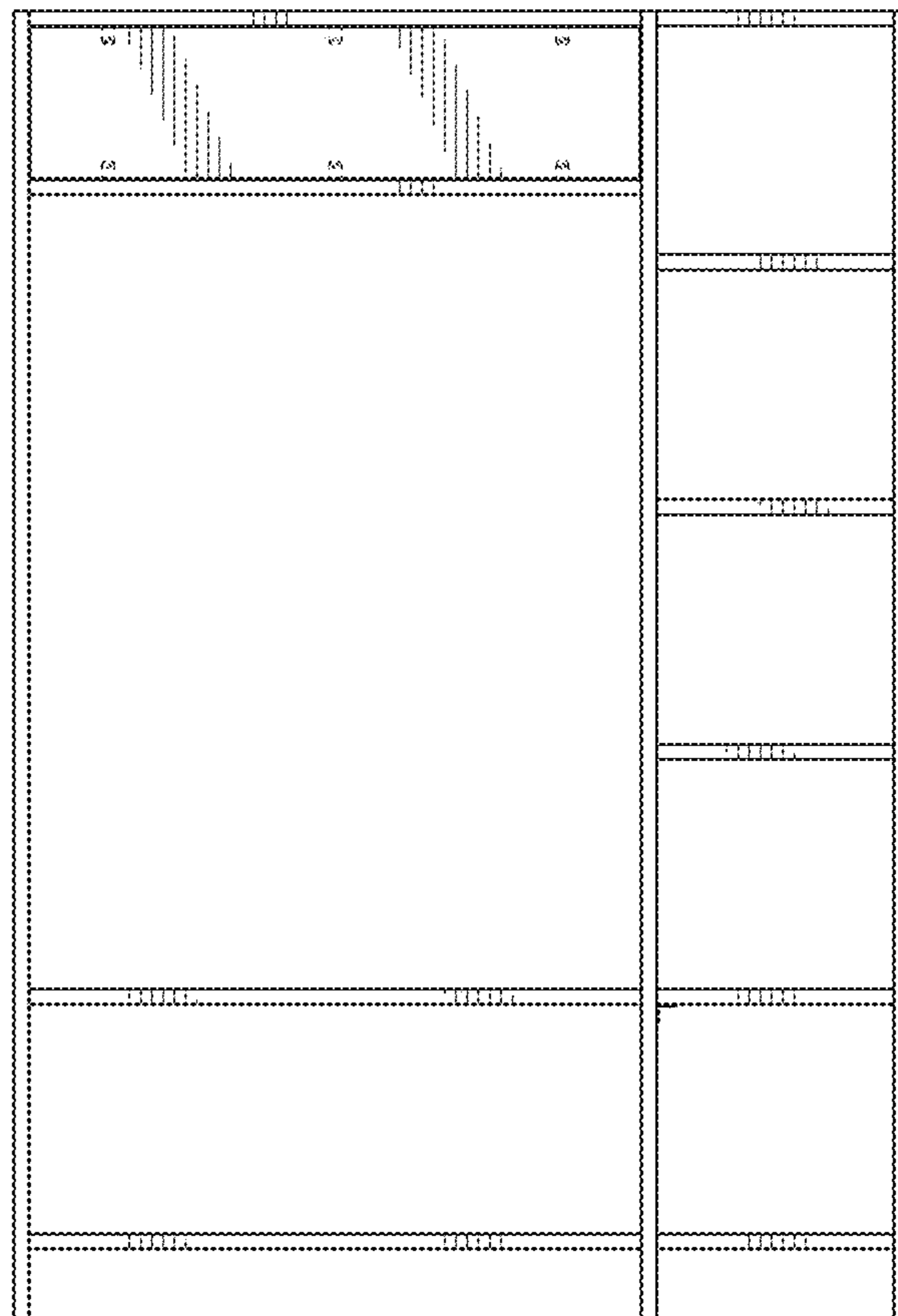

FIG. 3



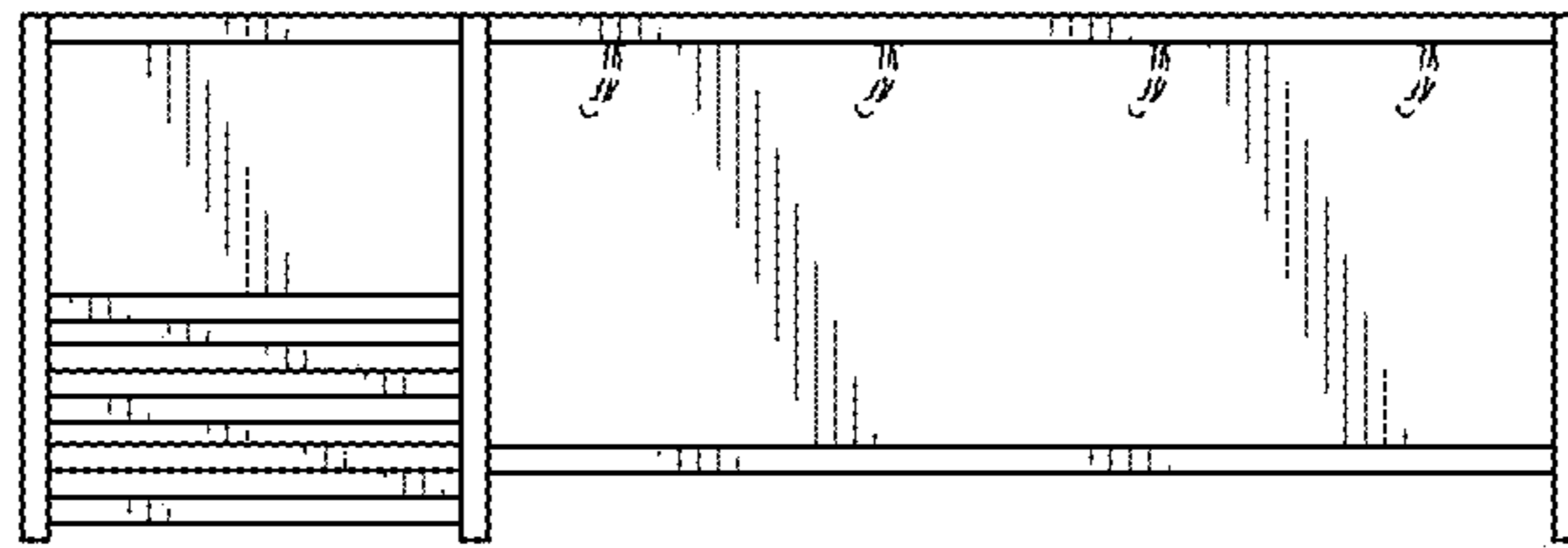

FIG. 4

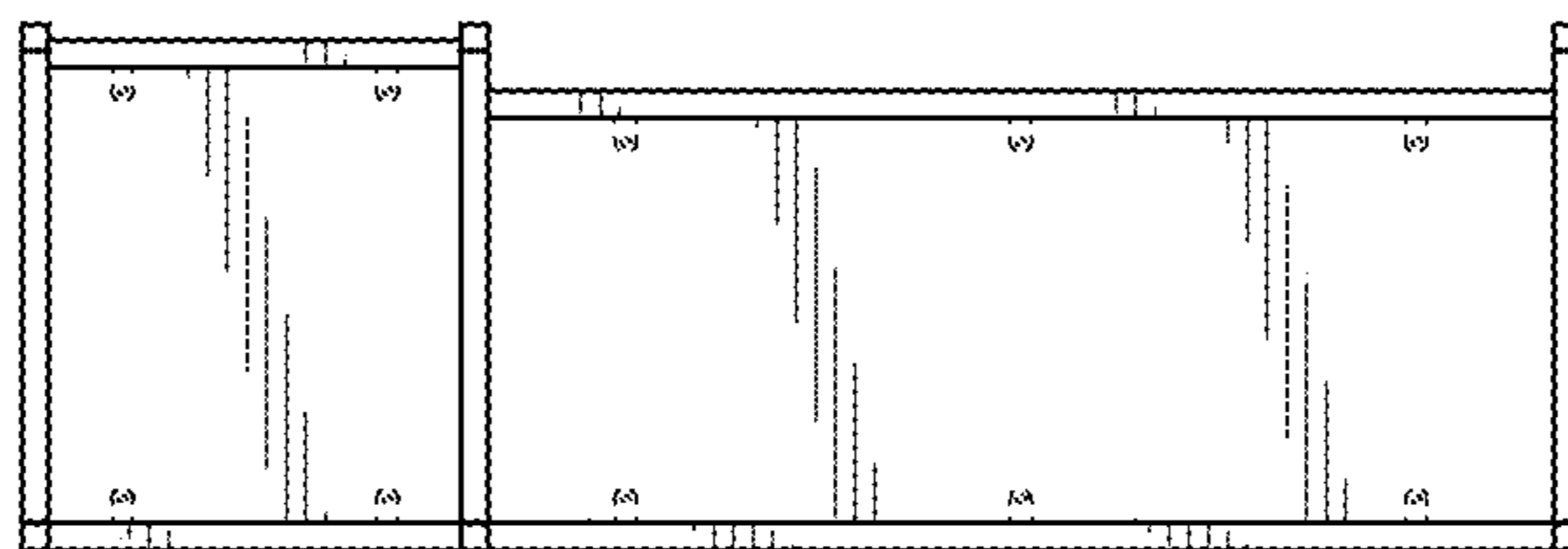

FIG. 5

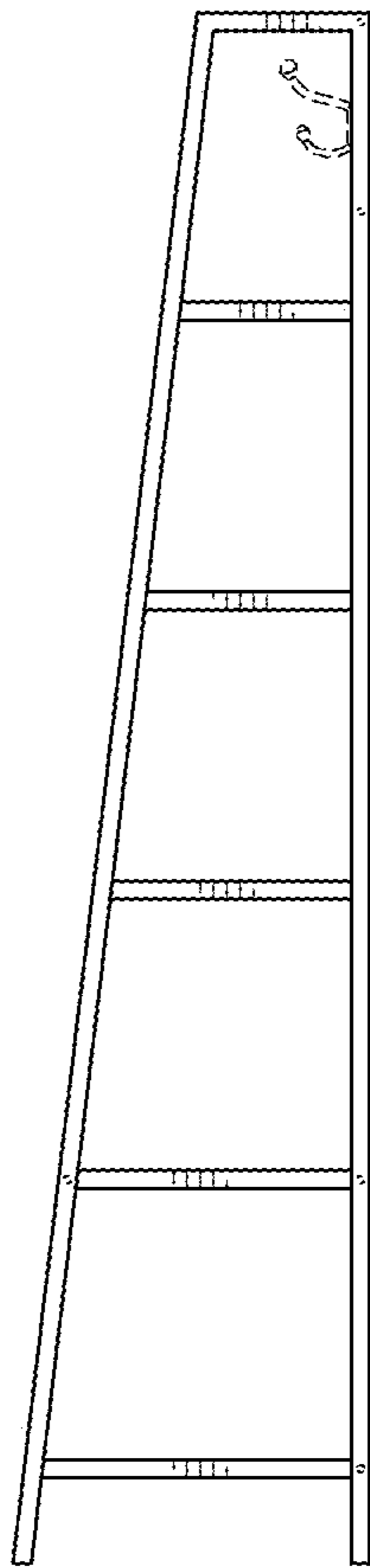

FIG. 6

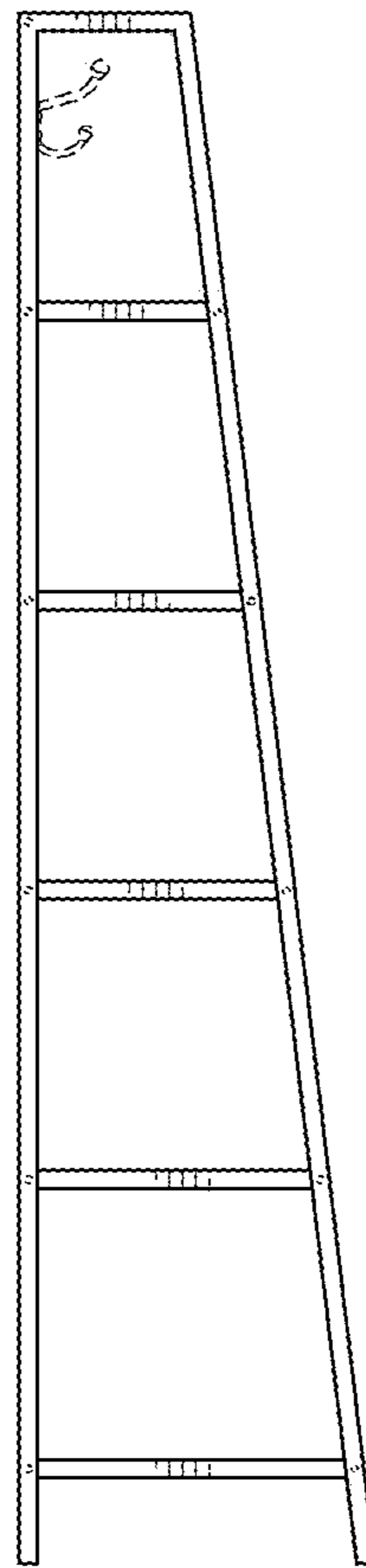

FIG. 7



FIG. 8

FIG. 9

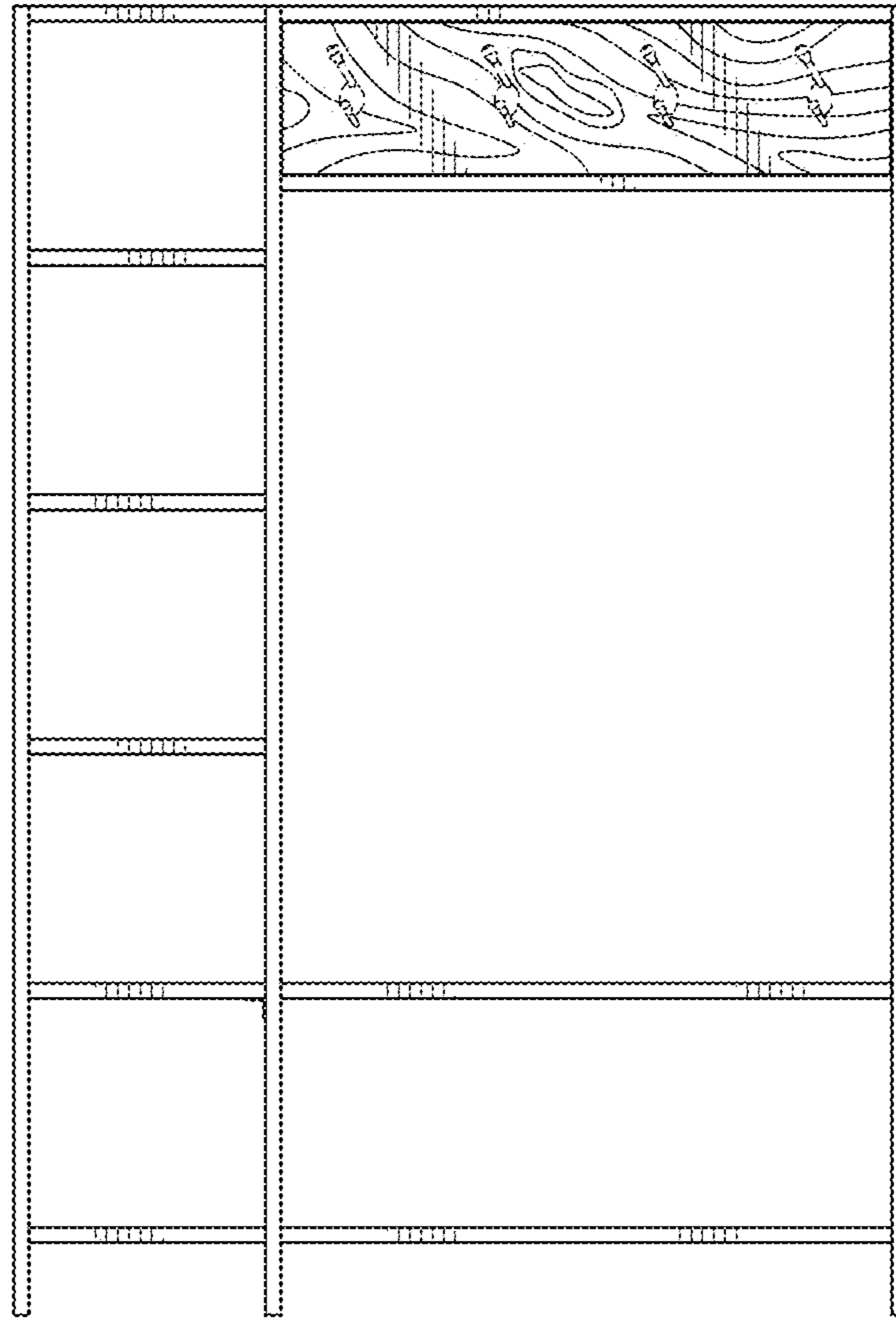
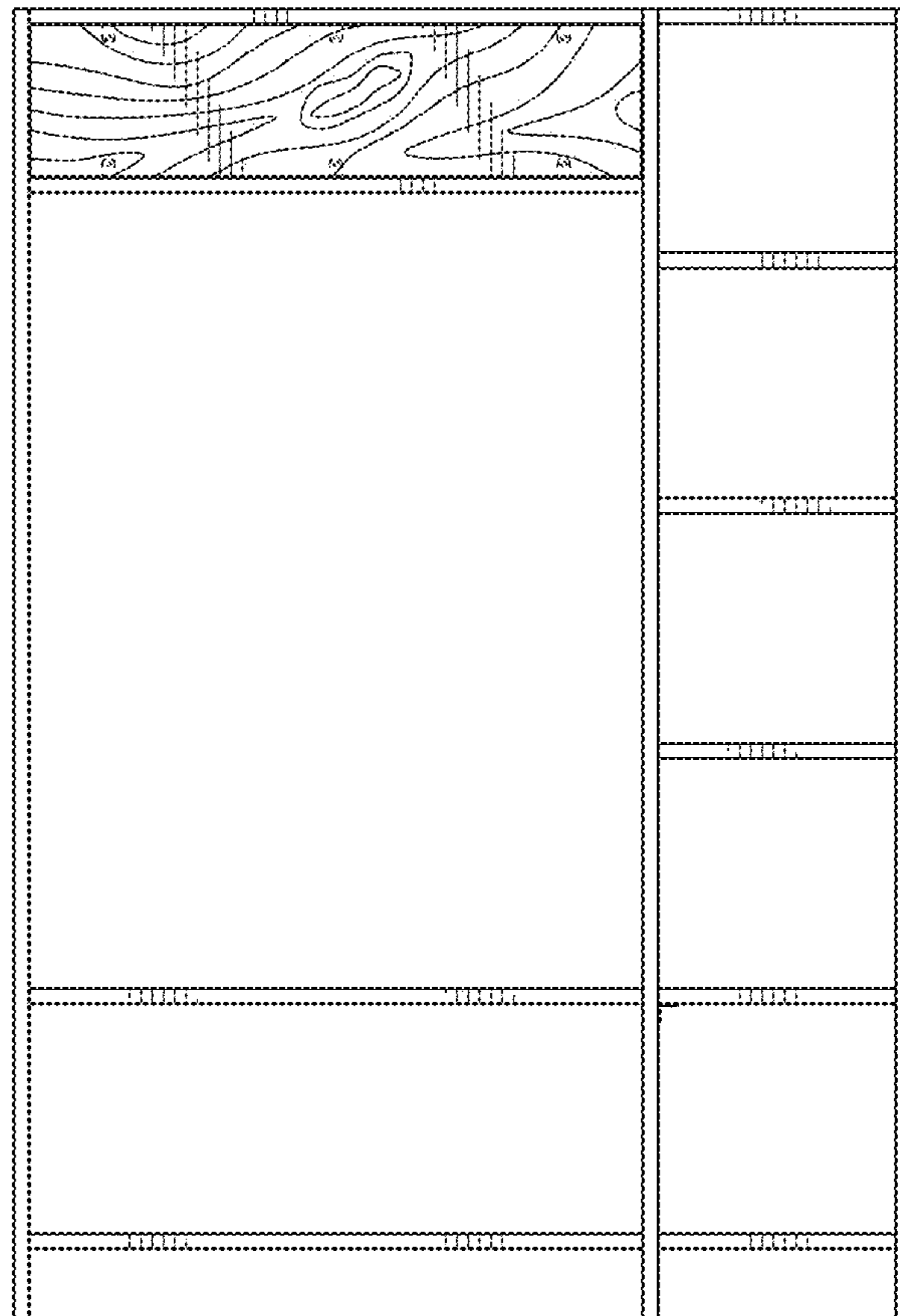

FIG. 10



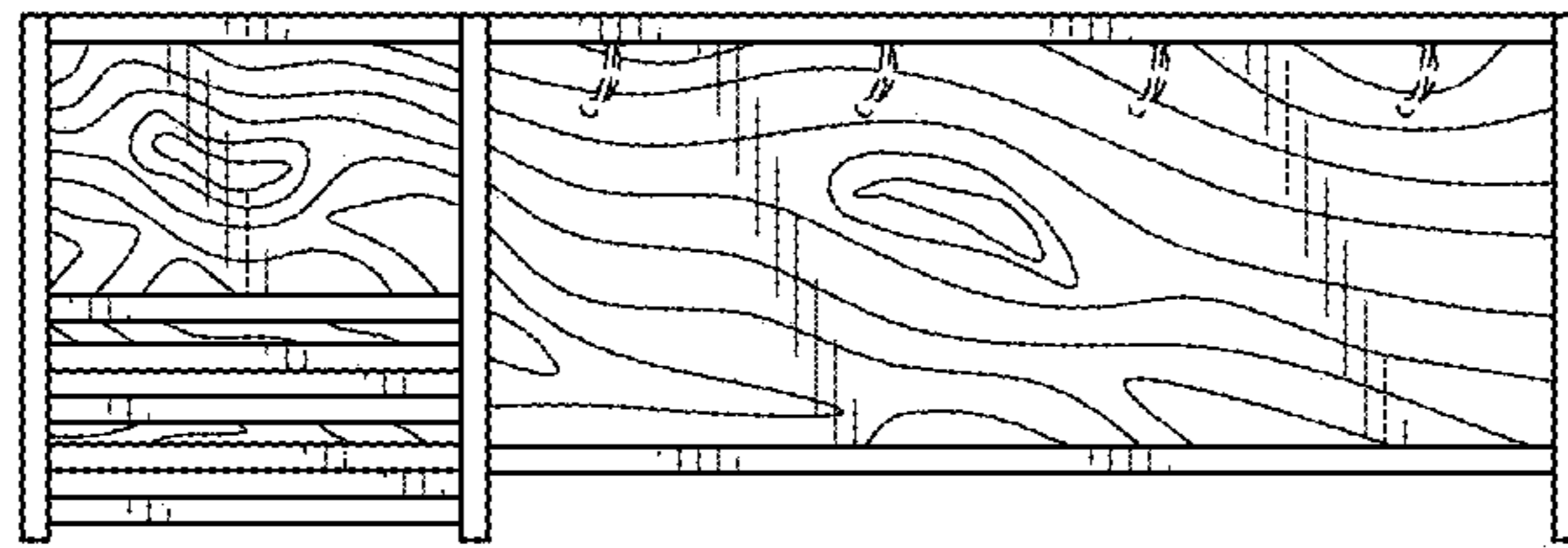

FIG. 11

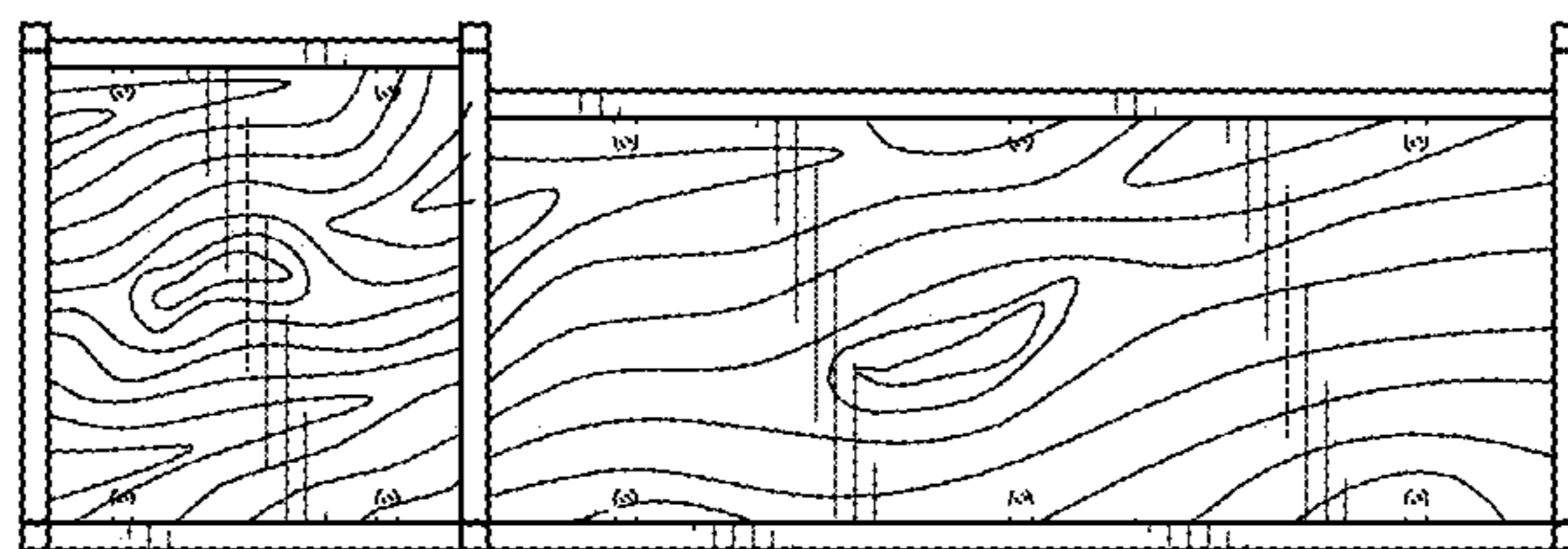

FIG. 12

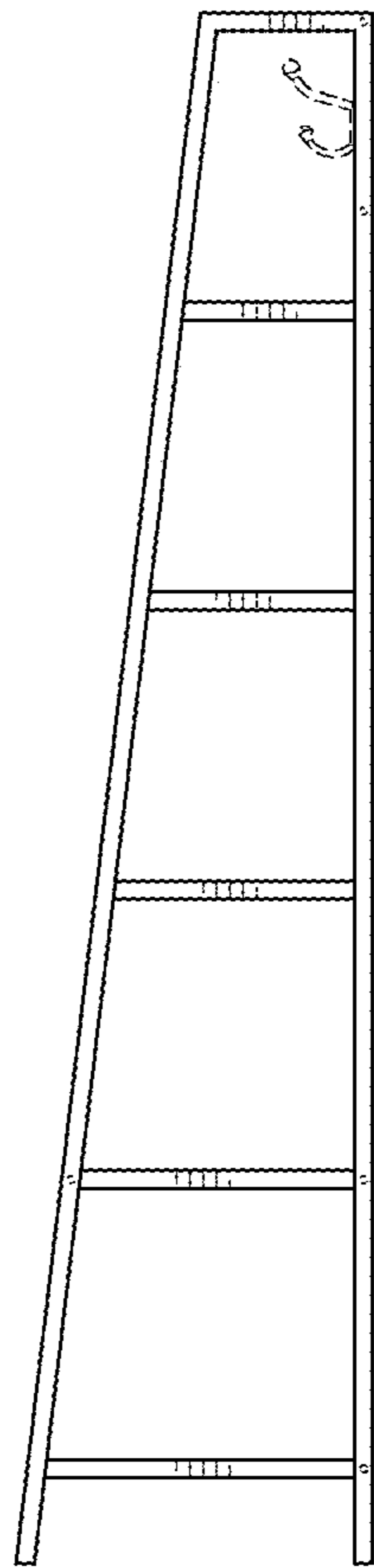

FIG. 13

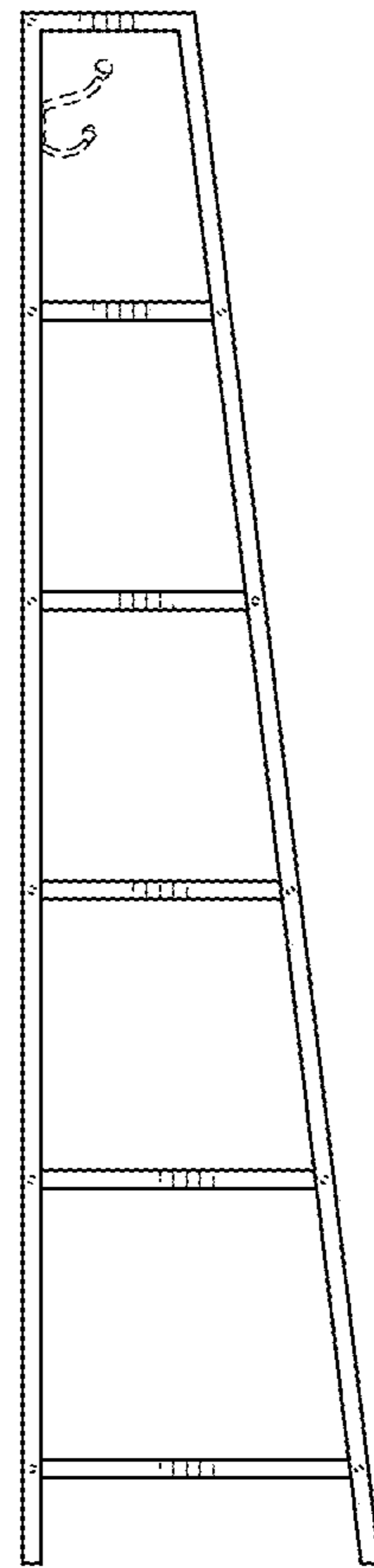

FIG. 14