



US00D941553S

(12) **United States Design Patent**
Abloh et al.

(10) **Patent No.: US D941,553 S**
(45) **Date of Patent: ** Jan. 25, 2022**

- (54) **NECKTIE**
- (71) Applicant: **OFF-WHITE, LLC**, New York, NY (US)
- (72) Inventors: **Virgil Abloh**, New York, NY (US);
Wayne Fitzell, Milan (IT)
- (73) Assignee: **OFF-WHITE, LLC**, New York, NY (US)
- (**) Term: **15 Years**
- (21) Appl. No.: **29/752,143**
- (22) Filed: **Sep. 25, 2020**
- (51) **LOC (13) Cl.** **02-05**
- (52) **U.S. Cl.**
USPC **D2/605**
- (58) **Field of Classification Search**
USPC D2/500, 600, 604, 605, 608
CPC A41D 23/00; A41D 25/00; A41D 25/001;
A41D 25/06
See application file for complete search history.

7,757,306 B2 * 7/2010 Mattioli A41D 25/001
2/144
D667,606 S * 9/2012 Botwinick D2/605
D875,347 S * 2/2020 Vu D2/605

OTHER PUBLICATIONS

Meteor Regimental Tie, [online]; [internet publication date unknown]; [retrieved from the internet on Oct. 5, 2021]; URL: <https://www.off-white.com/en-us/shopping/off-white-meteor-regimental-tie-16864855>. (2 pages). (Year: 2021).*

* cited by examiner

Primary Examiner — Jasmine Mlinarcik
(74) *Attorney, Agent, or Firm* — Epstein Drangel LLP;
Robert L. Epstein

(57) **CLAIM**

The ornamental design for a necktie, substantially as shown and described.

DESCRIPTION

FIG. 1 is an isometric view of the necktie showing the top, front and right side thereof;
FIG. 2 is an isometric view of the necktie showing the bottom, rear and left side thereof;
FIG. 3 is a front elevation view thereof;
FIG. 4 is a rear elevation view thereof;
FIG. 5 is an elevation view of the left side thereof;
FIG. 6 is an elevation view of the right side thereof;
FIG. 7 is a top plan view thereof; and,
FIG. 8 is a bottom plan view thereof.

1 Claim, 5 Drawing Sheets

(56) **References Cited**
U.S. PATENT DOCUMENTS

- 2,787,002 A * 4/1957 De La Piedra A41D 25/022
2/153
- D321,276 S * 11/1991 Weeks D2/605
- 5,571,218 A * 11/1996 Caniglia A41B 1/08
2/115
- D399,035 S * 10/1998 Sisolak D2/605
- 7,530,119 B1 * 5/2009 Jackson-Miller A41D 25/003
2/144
- 7,698,748 B2 * 4/2010 Kim A41D 25/06
2/144

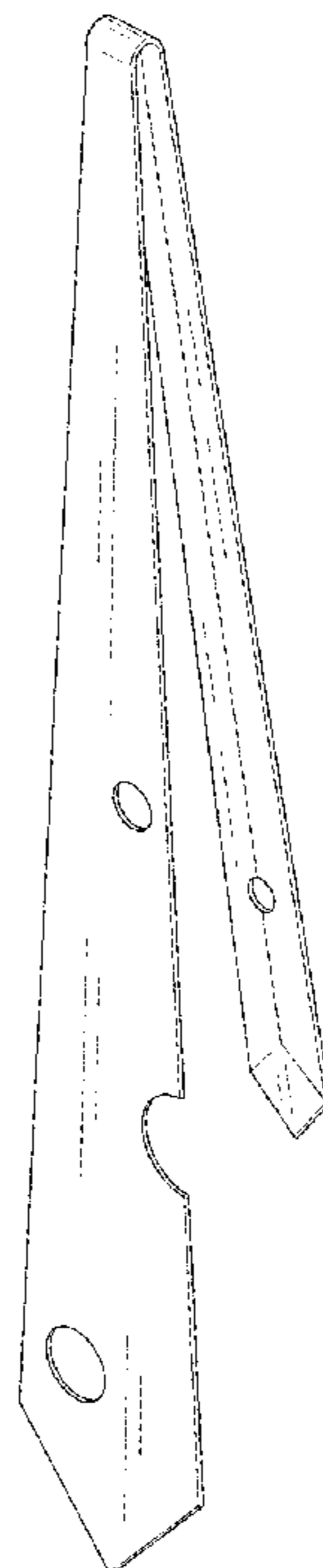

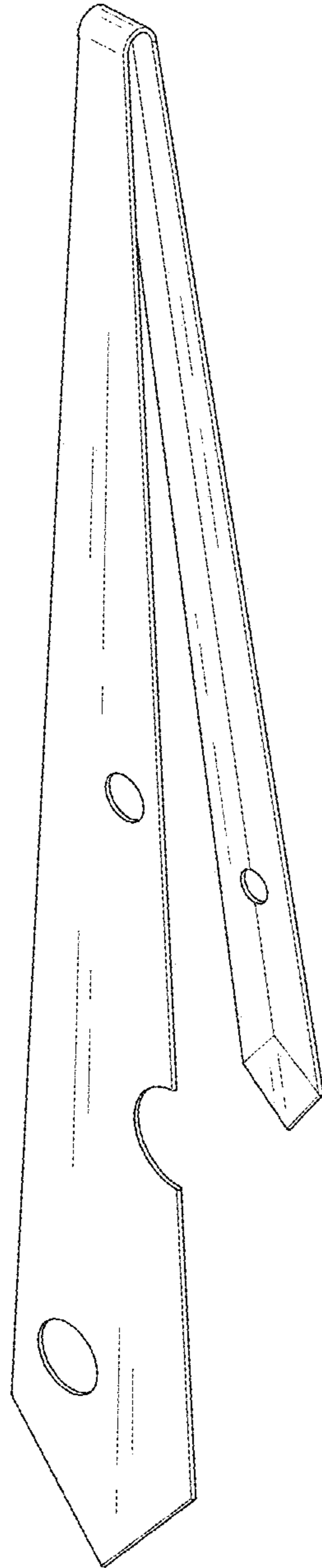

FIG. 1

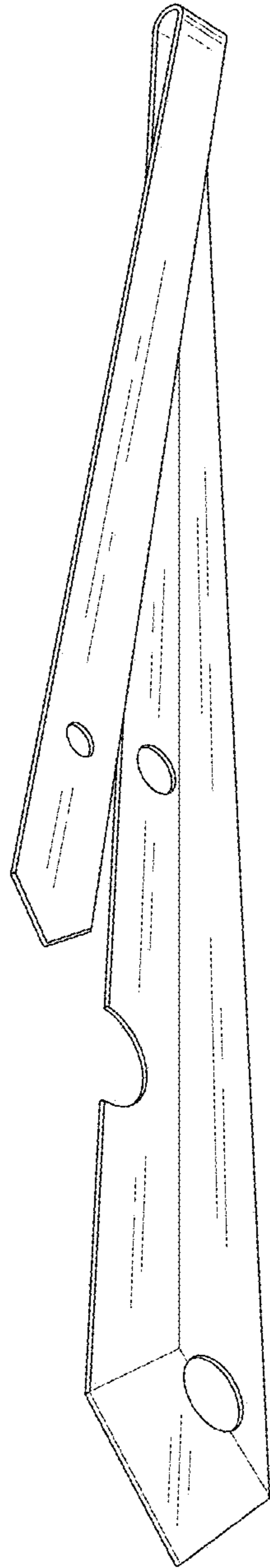

FIG. 2

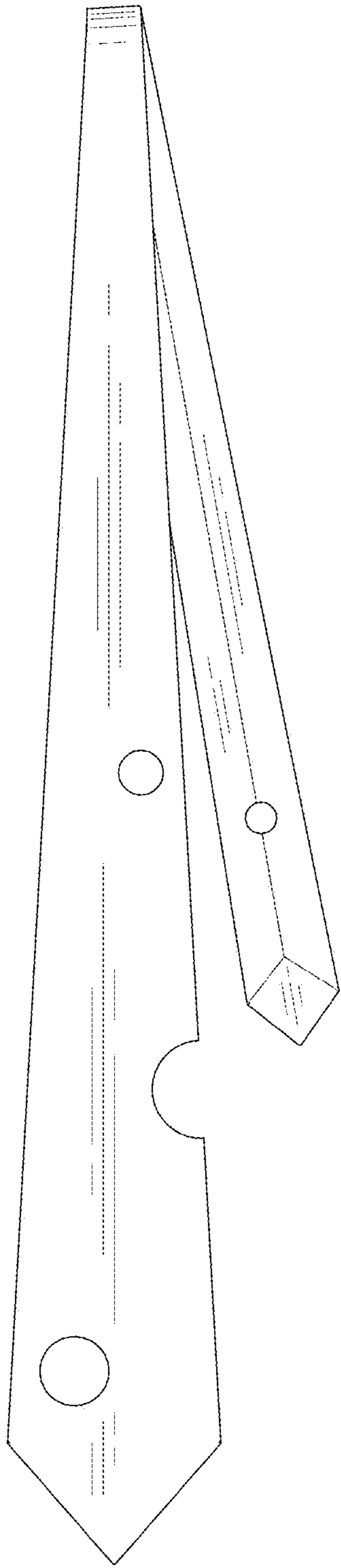

FIG. 3

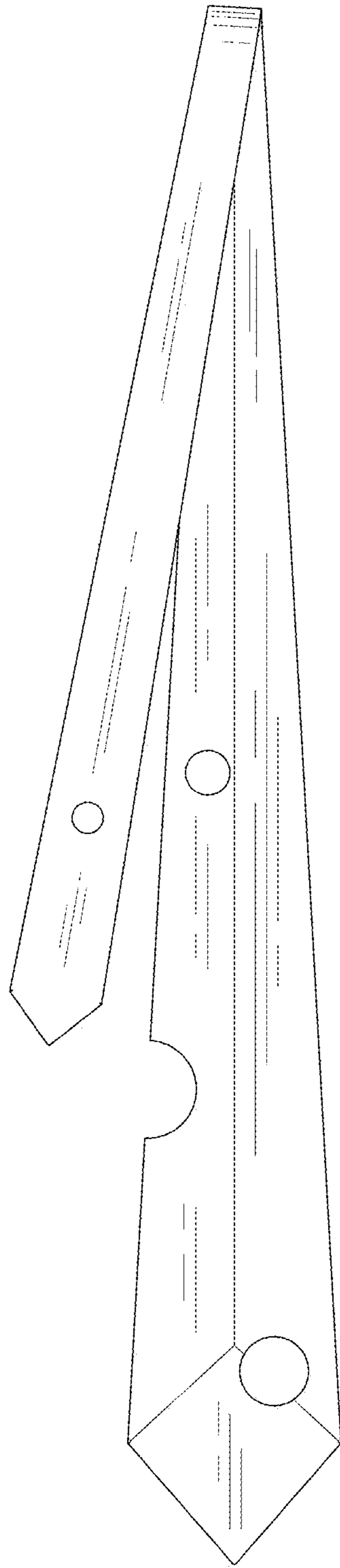

FIG. 4



FIG. 5

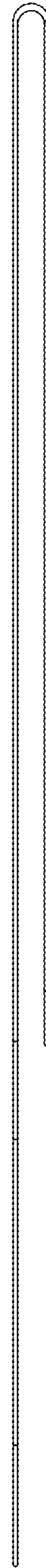

FIG. 6

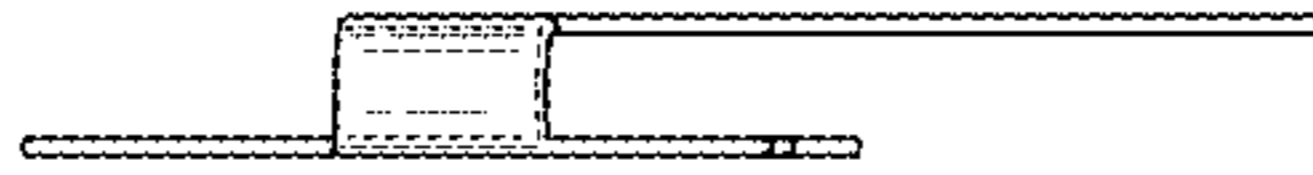

FIG. 7



FIG. 8