



US00D941410S

(12) **United States Design Patent**
Scott et al.

(10) **Patent No.:** **US D941,410 S**
(45) **Date of Patent:** **** Jan. 18, 2022**

- (54) **MULTI-TRIANGLE PUTTER**
- (71) Applicants: **Philip Andrew Scott**, Sanctuary Cove (AU); **Fatiha Sahnoune**, Sanctuary Cove (AU)
- (72) Inventors: **Philip Andrew Scott**, Sanctuary Cove (AU); **Fatiha Sahnoune**, Sanctuary Cove (AU)
- (**) Term: **15 Years**
- (21) Appl. No.: **29/741,229**
- (22) Filed: **Jul. 10, 2020**
- (51) **LOC (13) Cl.** **21-02**
- (52) **U.S. Cl.**
USPC **D21/736**
- (58) **Field of Classification Search**
USPC D21/736-746, 759
CPC A63B 53/00; A63B 53/04; A63B 53/007;
A63B 53/065; A63B 53/048; A63B 60/00; A63B 60/04
See application file for complete search history.

- D500,539 S * 1/2005 Holloway D21/736
- D502,518 S * 3/2005 Smart D21/736
- D509,273 S * 9/2005 Morris D21/742
- D543,252 S * 5/2007 Haggstrom D21/736
- 7,347,793 B2 * 3/2008 Davis A63B 60/02
473/305
- D598,966 S * 8/2009 Pontius D21/743
- D600,759 S * 9/2009 Cokewell D21/736
- D791,254 S * 7/2017 Ramsauer D21/744
- 2021/0331043 A1 * 10/2021 Scott A63B 53/02

* cited by examiner

Primary Examiner — Mitchell I. Siegel

(57) **CLAIM**

The ornamental design for a multi-triangle putter, as shown and described.

DESCRIPTION

FIG. 1 is a front-top perspective view of a multi-triangle putter showing my new design;
 FIG. 2 is a front-bottom perspective view thereof;
 FIG. 3 is a rear-top perspective view thereof;
 FIG. 4 is a front elevational view thereof, where the rear elevational view is mirrored thereto;
 FIG. 5 is a right elevational view thereof;
 FIG. 6 is a left elevational view thereof; and,
 FIG. 7 is a top plan view thereof, where the bottom plan view is identical thereto.

1 Claim, 7 Drawing Sheets

- (56) **References Cited**
U.S. PATENT DOCUMENTS
D229,844 S * 1/1974 Pavelle D21/741
D438,858 S * 3/2001 del Castillo D14/188

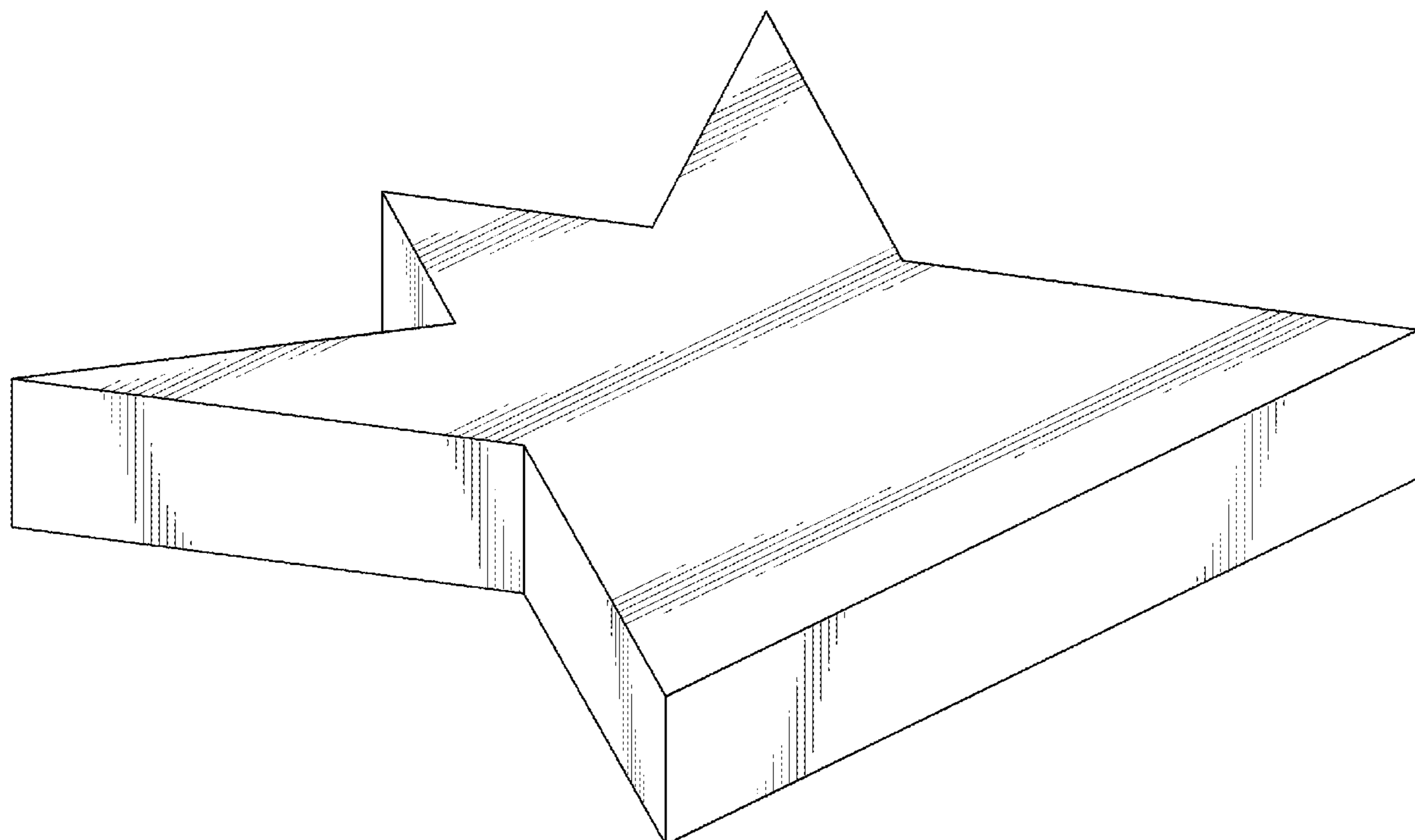

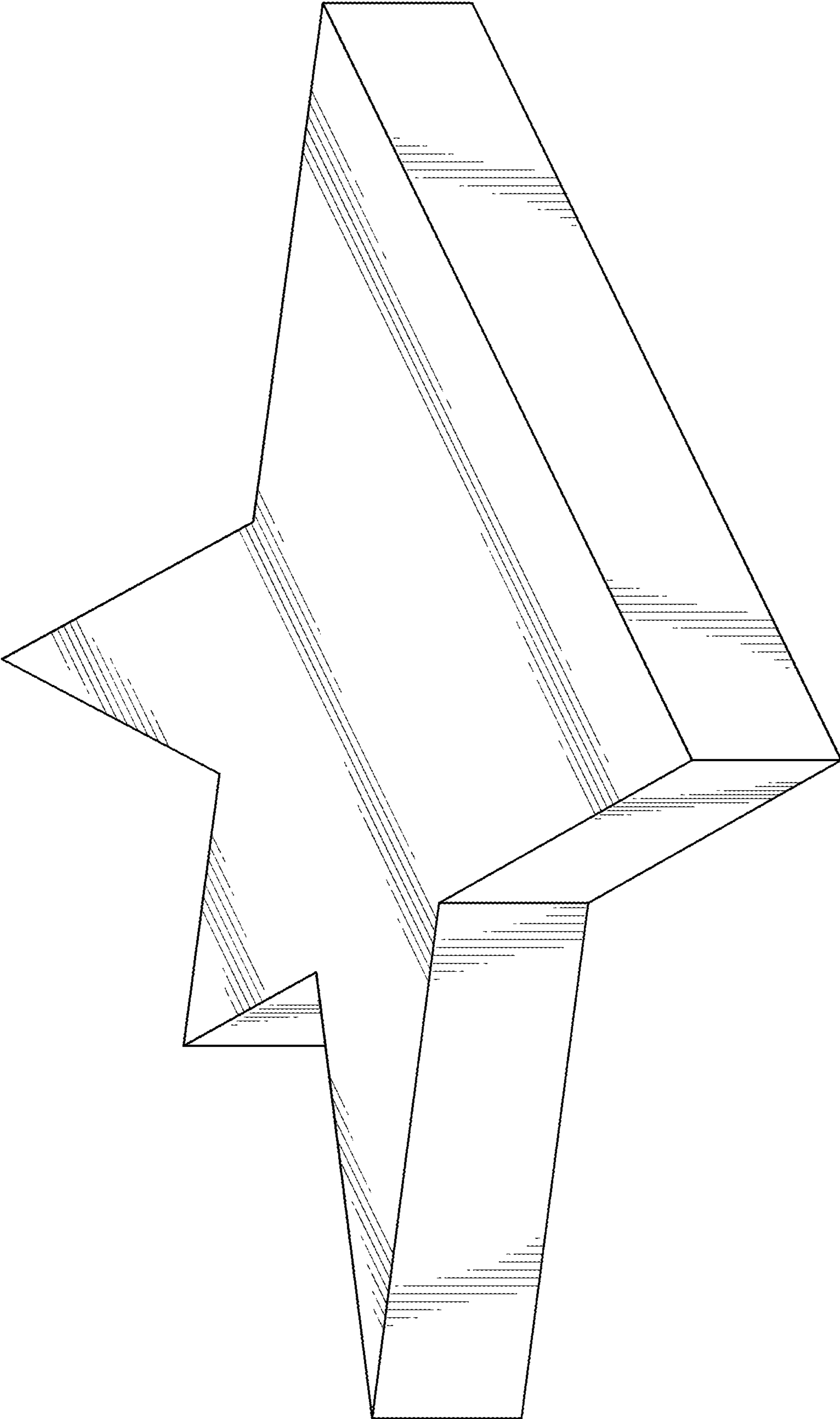

FIG. 1

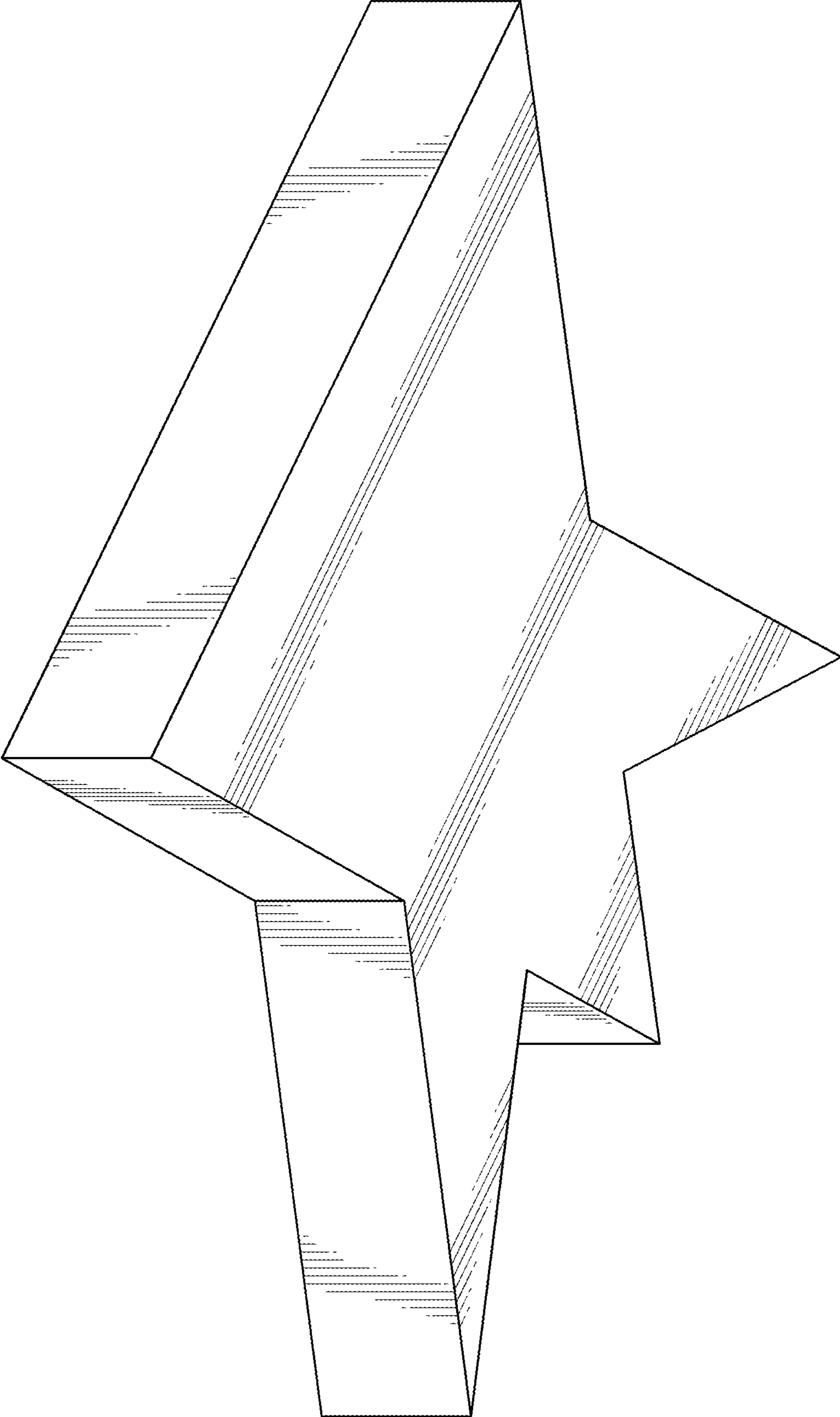

FIG. 2

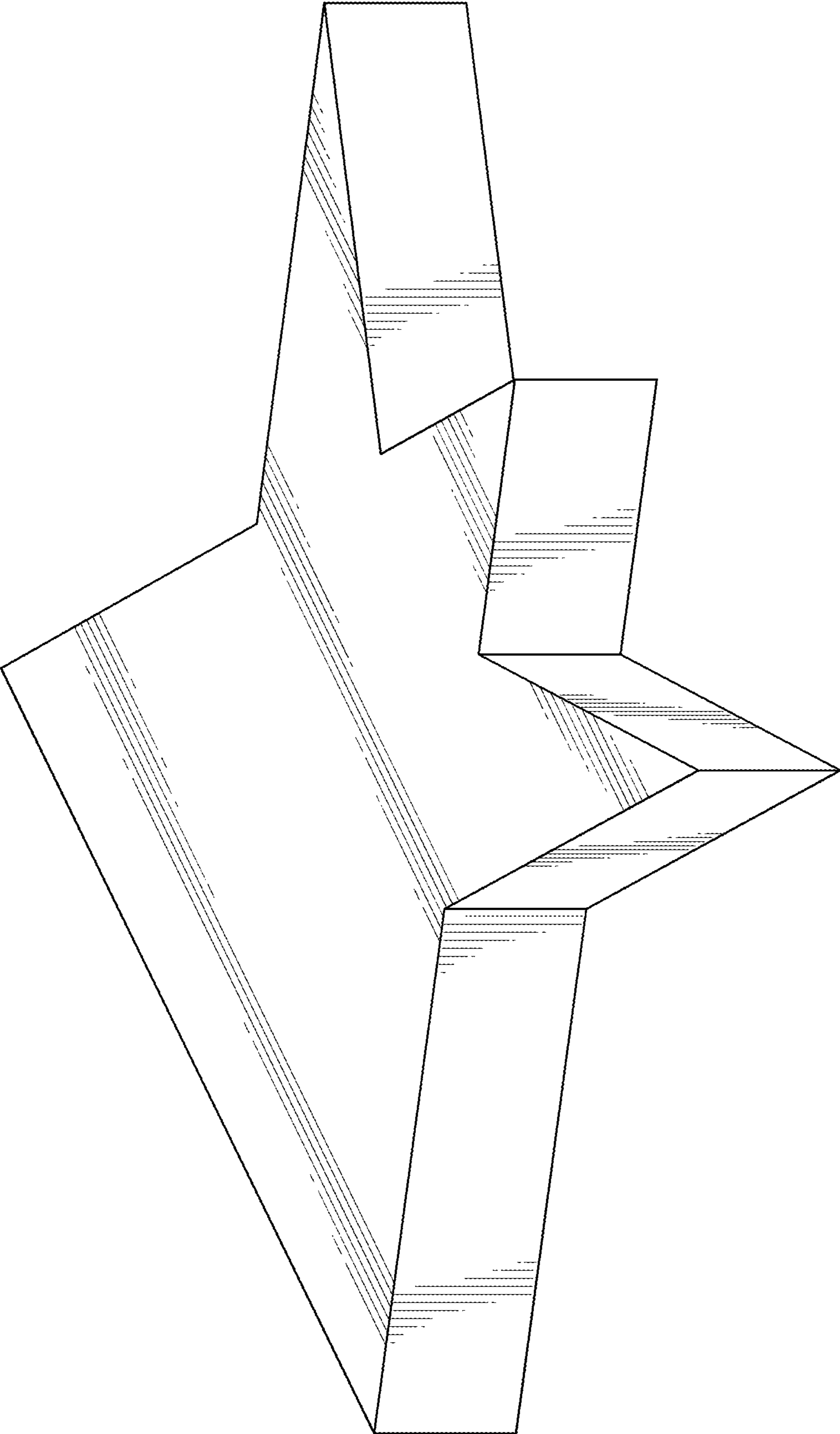

FIG. 3

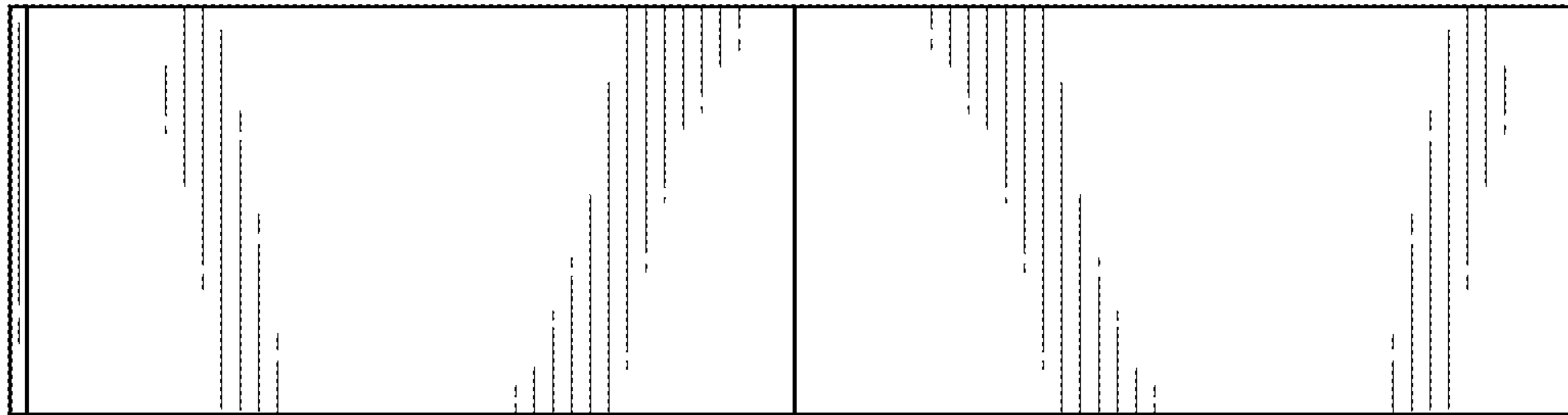

FIG. 4

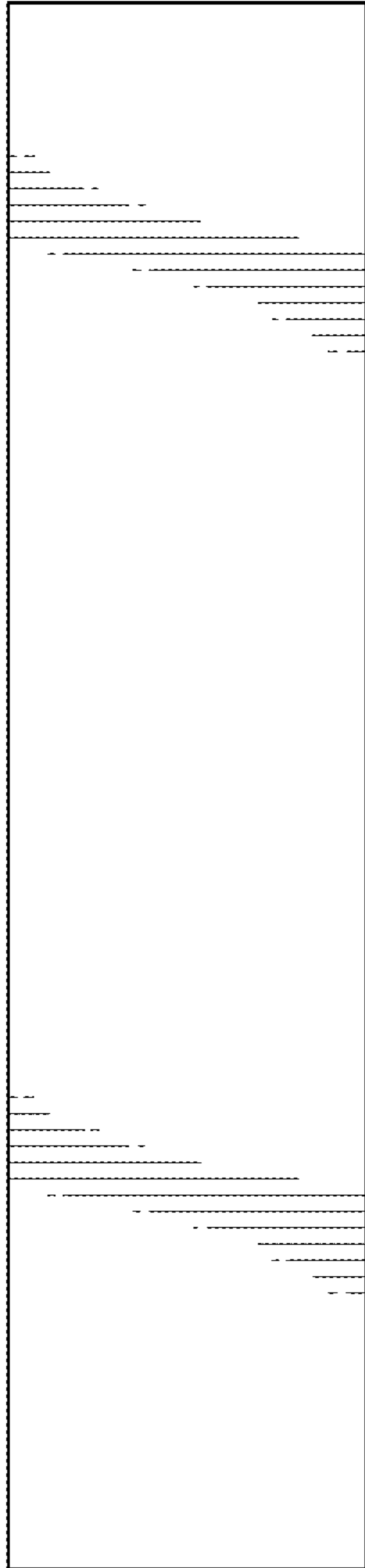

FIG. 5

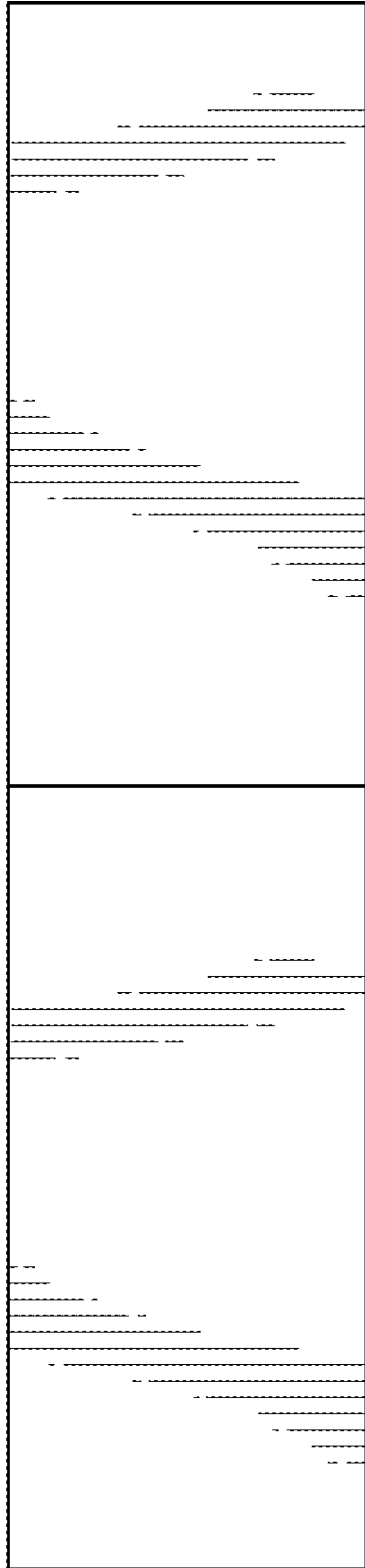

FIG. 6

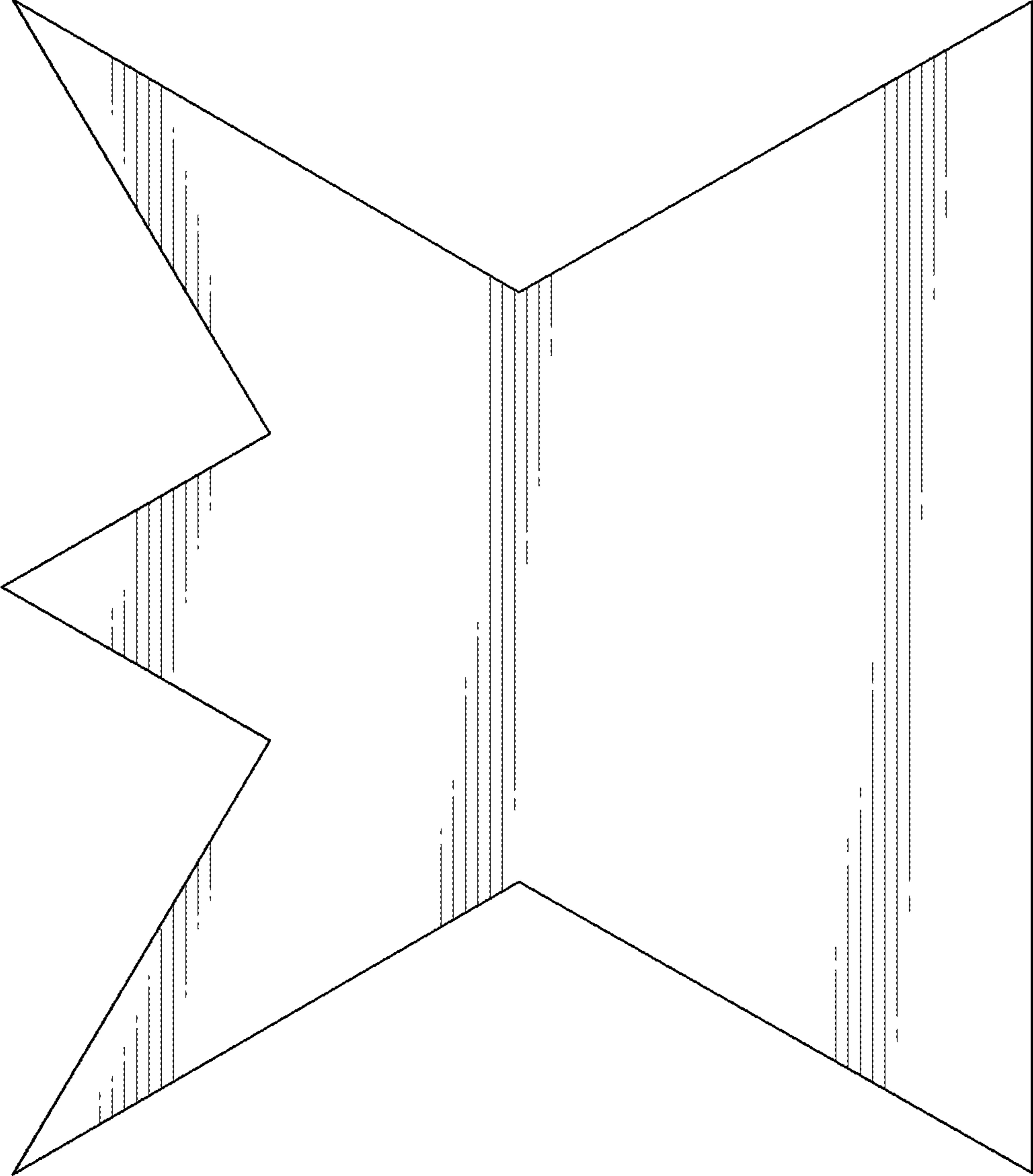

FIG. 7