



US00D941237S

(12) **United States Design Patent** (10) **Patent No.:** **US D941,237 S**  
**Floyd** (45) **Date of Patent:** **\*\* \*Jan. 18, 2022**

(54) **POCKET VAPORIZATION BATTERY**  
(71) Applicant: **Evan Floyd**, Carmichael, CA (US)  
(72) Inventor: **Evan Floyd**, Carmichael, CA (US)  
(\* ) Notice: This patent is subject to a terminal disclaimer.  
(\*\*) Term: **15 Years**  
(21) Appl. No.: **29/705,974**  
(22) Filed: **Sep. 17, 2019**  
(51) **LOC (13) Cl.** ..... **13-02**  
(52) **U.S. Cl.**  
USPC ..... **D13/103**; D27/162  
(58) **Field of Classification Search**  
USPC ..... D27/100, 101, 162, 163, 164, 165, 166, D27/167, 168, 169, 170, 171, 172, 173, D27/174, 175, 176, 177, 178, 179, 180, D27/181, 182, 183, 184, 185, 186, 187, D27/188, 189, 190, 191, 192, 193; D24/110, 110.4, 110.5, 110.6, 113; D28/91.1; D23/360, 362; D13/107, 108, D13/119, 103  
CPC ..... A24F 47/008; A24F 40/10; A24F 40/40; A24F 40/46; A24F 40/42; A24F 40/44; A24F 40/50; A24F 40/90; A24F 47/00; A24F 40/60; A24F 40/70; A24F 40/48; A24F 40/485; A24F 40/53; A24F 40/51; A24F 47/002; A24F 40/57; A24F 40/65; A24F 40/20; A24F 7/00; A24F 40/30; A24F 47/004; A24F 40/05; A24F 15/00; A24F 1/32; A24F 40/00; A24F 40/49; A24F 40/85; A24F 42/60; A24F 7/02; A24F 7/04; A24F 9/16; A24F 40/465; A24F 13/00; A24F 13/14; A24F 15/01; A24F 15/12; A24F 15/14; A24F 15/18; A24F 1/02; A24F 2700/03; A24F 42/00; A24F 42/20; A24F 15/015; A24F 1/00; A24F 13/06; A24F 13/04; A24F 40/95; A61M 11/042; A61M 15/06; A61M 2205/8206; A61M

(Continued)

(56) **References Cited**  
U.S. PATENT DOCUMENTS  
D752,808 S \* 3/2016 Hearn ..... D27/189  
D758,655 S \* 6/2016 Freshwater ..... D27/163  
(Continued)

FOREIGN PATENT DOCUMENTS  
CN 201830127884 \* 12/2018

OTHER PUBLICATIONS  
New 2019 Cloak 510 Vape Battery Stealth 650mah. By Tacoma Clouds. Dated Feb. 27, 2019. Found online [Jan. 6, 2021]. <https://www.youtube.com/watch?v=UmjFtUa94qA> (Year: 2019).\*  
(Continued)

*Primary Examiner* — Marissa J Cash  
*Assistant Examiner* — William B Melliar  
(74) *Attorney, Agent, or Firm* — Gary L. Eastman, Esq.; Eastman IP

(57) **CLAIM**  
The ornamental design for a pocket vaporization battery, as shown and described.

**DESCRIPTION**  
FIG. 1 is a front upper perspective view of the pocket vaporization battery of the present invention;  
FIG. 2 is a back lower perspective view thereof;  
FIG. 3 is a front view thereof;  
FIG. 4 is a back view thereof;  
FIG. 5 is a left view thereof;  
FIG. 6 is a right view thereof;  
FIG. 7 is a top view thereof; and,  
FIG. 8 is a bottom view thereof.  
The broken lines shown in the drawings depict portions of the pocket vaporization battery that form no part of the claimed design.

**1 Claim, 4 Drawing Sheets**

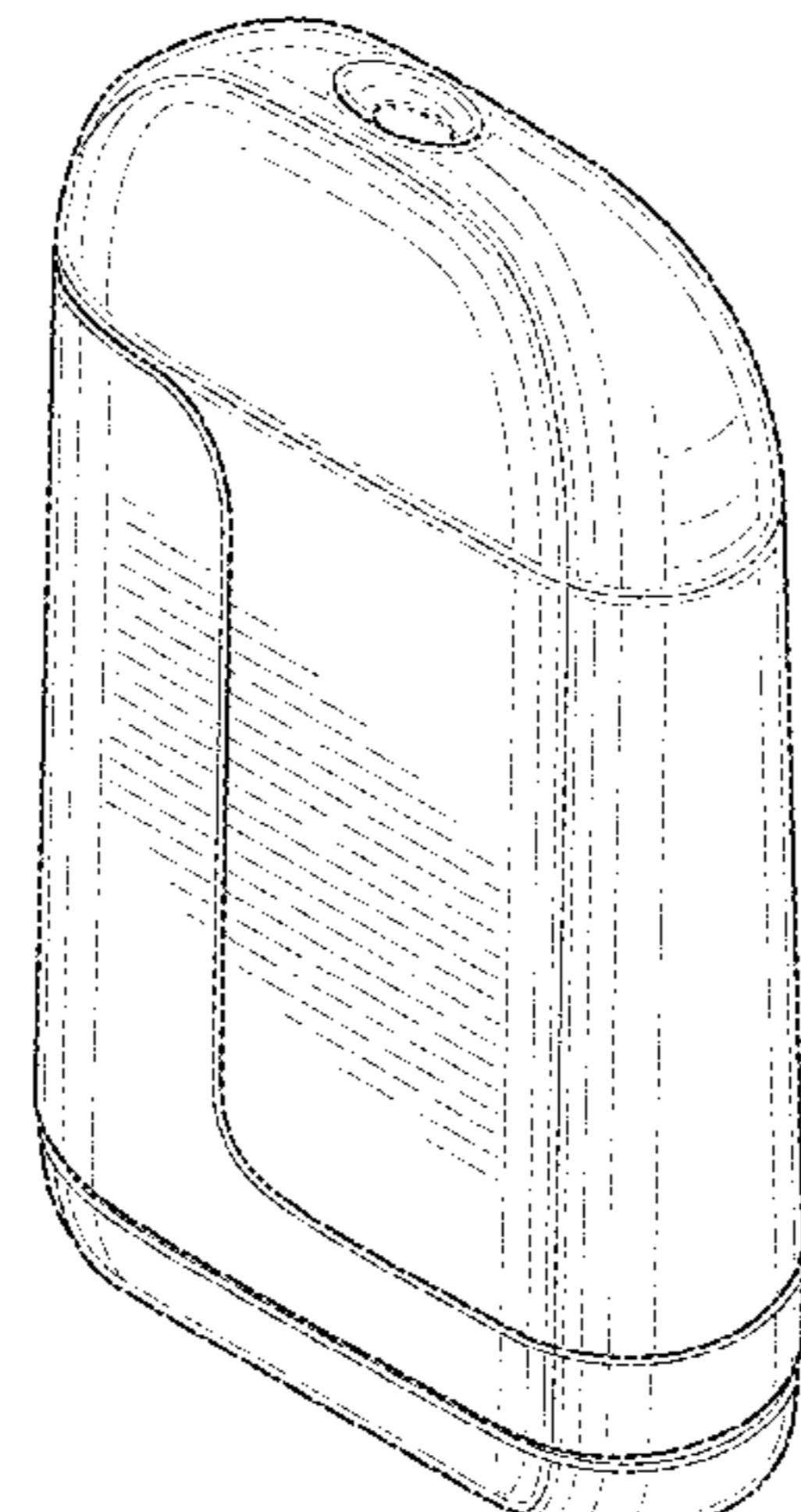

(58) **Field of Classification Search**

CPC ..... 2205/3653; A61M 11/005; A61M 2016/0024; A61M 2016/0027; A61M 2205/587; A61M 11/044; A61M 15/0085; A61M 16/0003; A61M 2205/0211; A61M 2205/3368; A61M 2205/8256; A61M 11/003; A61M 15/002; A61M 2016/0021; A61M 11/001; A61M 11/04; A61M 15/0021; A61M 15/0025; A61M 15/008; A61M 2016/0018; A61M 2016/0033; A61M 2016/0039; A61M 2021/0016; A61M 21/00; A61M 2205/3331; A61M 2205/3334; A61M 2205/3379; A61M 2205/52; A61M 2205/58; A61M 2205/583; A61M 2205/6018; A61M 2205/6054; A61M 2205/75; A61M 2205/8268; A61M 2206/11; A61M 2206/20; A61M 2209/02; A61M 2209/045; A61M 11/041; A61M 15/0001; A61M 15/0015; A61M 15/0028; A61M 15/0091; A61M 15/0095; A61M 16/0808; A61M 2205/0238; A61M 2205/0272; A61M 2205/123; A61M 2205/7536; A61M 2205/18; A61M 2205/3317; A61M 2205/3386; A61M 2205/50

See application file for complete search history.

(56) **References Cited**

U.S. PATENT DOCUMENTS

D790,455 S \* 6/2017 McGarry ..... D13/107  
 D806,311 S \* 12/2017 Smith ..... D27/162

D820,514 S \* 6/2018 Durand ..... D27/162  
 D846,796 S \* 4/2019 Pan ..... D27/101  
 D846,798 S \* 4/2019 Chen ..... D27/163  
 D852,408 S \* 6/2019 Nettenstrom ..... D27/101  
 D853,632 S \* 7/2019 Qiu ..... D27/101  
 D864,471 S \* 10/2019 Cheng ..... D27/101  
 D874,718 S \* 2/2020 Qiu ..... D27/162  
 D884,961 S \* 5/2020 He ..... D27/101  
 D887,630 S \* 6/2020 Lai ..... D27/162  
 D887,631 S \* 6/2020 Lai ..... D27/162  
 D890,695 S \* 7/2020 Chang ..... D13/107  
 D900,385 S \* 10/2020 Wang ..... D27/162  
 D901,002 S \* 11/2020 Finger ..... D24/110  
 D902,475 S \* 11/2020 Liu ..... D27/162  
 D903,936 S \* 12/2020 He ..... D27/162  
 D921,282 S \* 6/2021 Yan ..... D27/162  
 D927,053 S \* 8/2021 Liu ..... D27/162  
 D927,054 S \* 8/2021 Liu ..... D27/162  
 D935,091 S \* 11/2021 Smith ..... D27/162

OTHER PUBLICATIONS

Hamilton Devices Reviews—Cloak Vaporizer Battery. By Joseph G. Dated Mar. 25, 2019. Found online [Jan. 6, 2021]. <https://www.slyng.com/news/review-hamilton-devices-cloak-vaporizer-battery-963> (Year: 2019).\*

\* cited by examiner

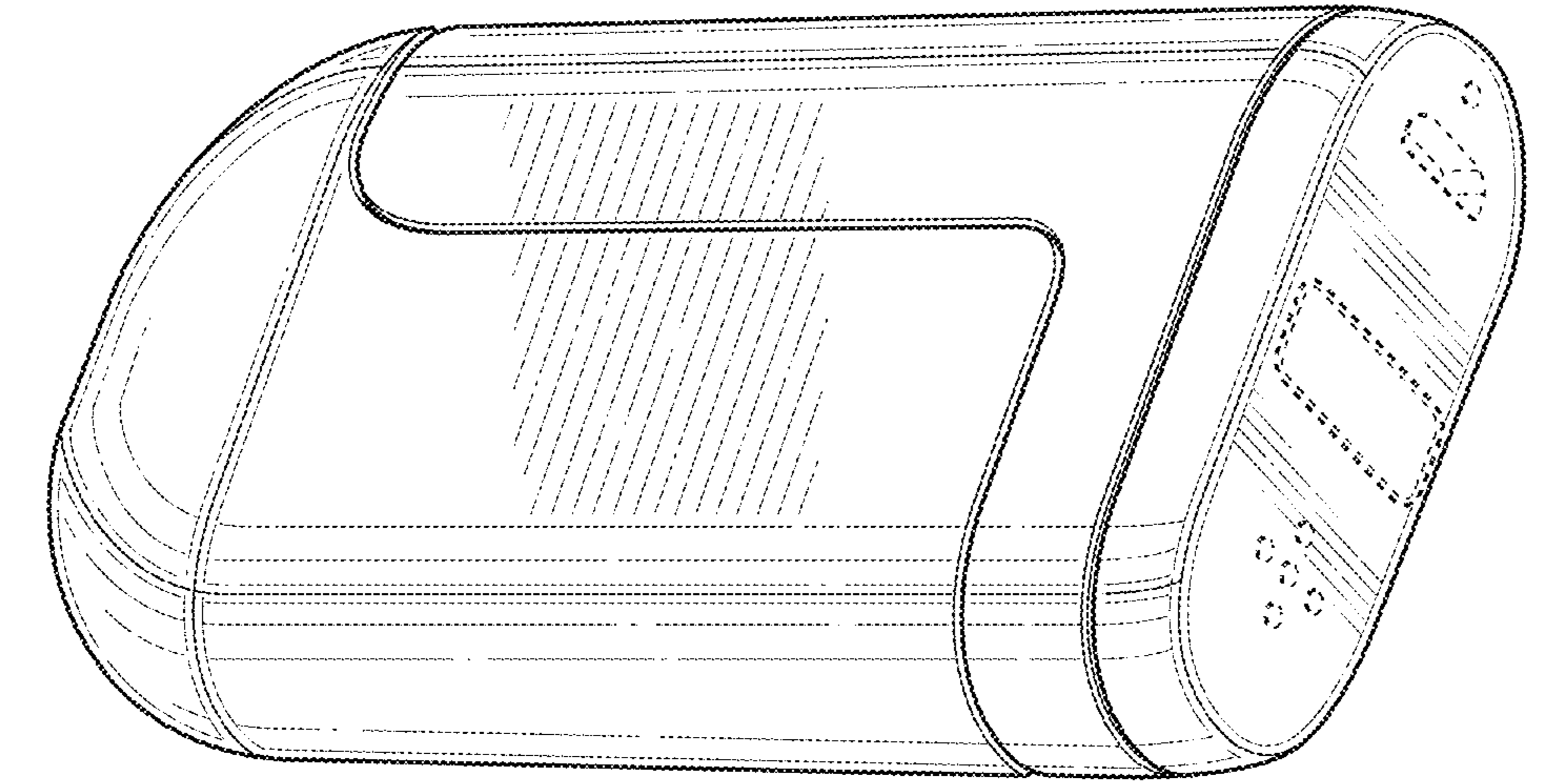

FIG. 1

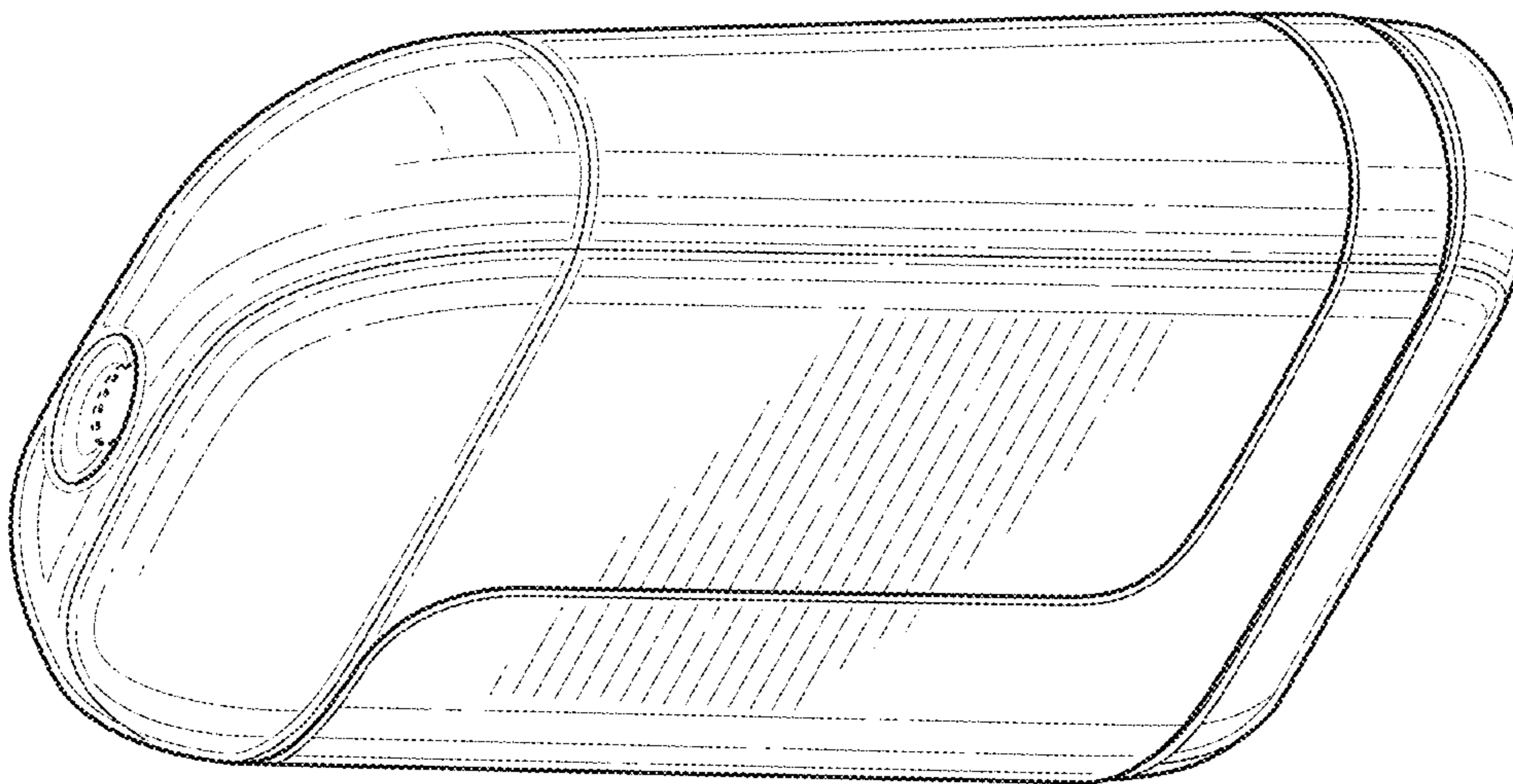

FIG. 2

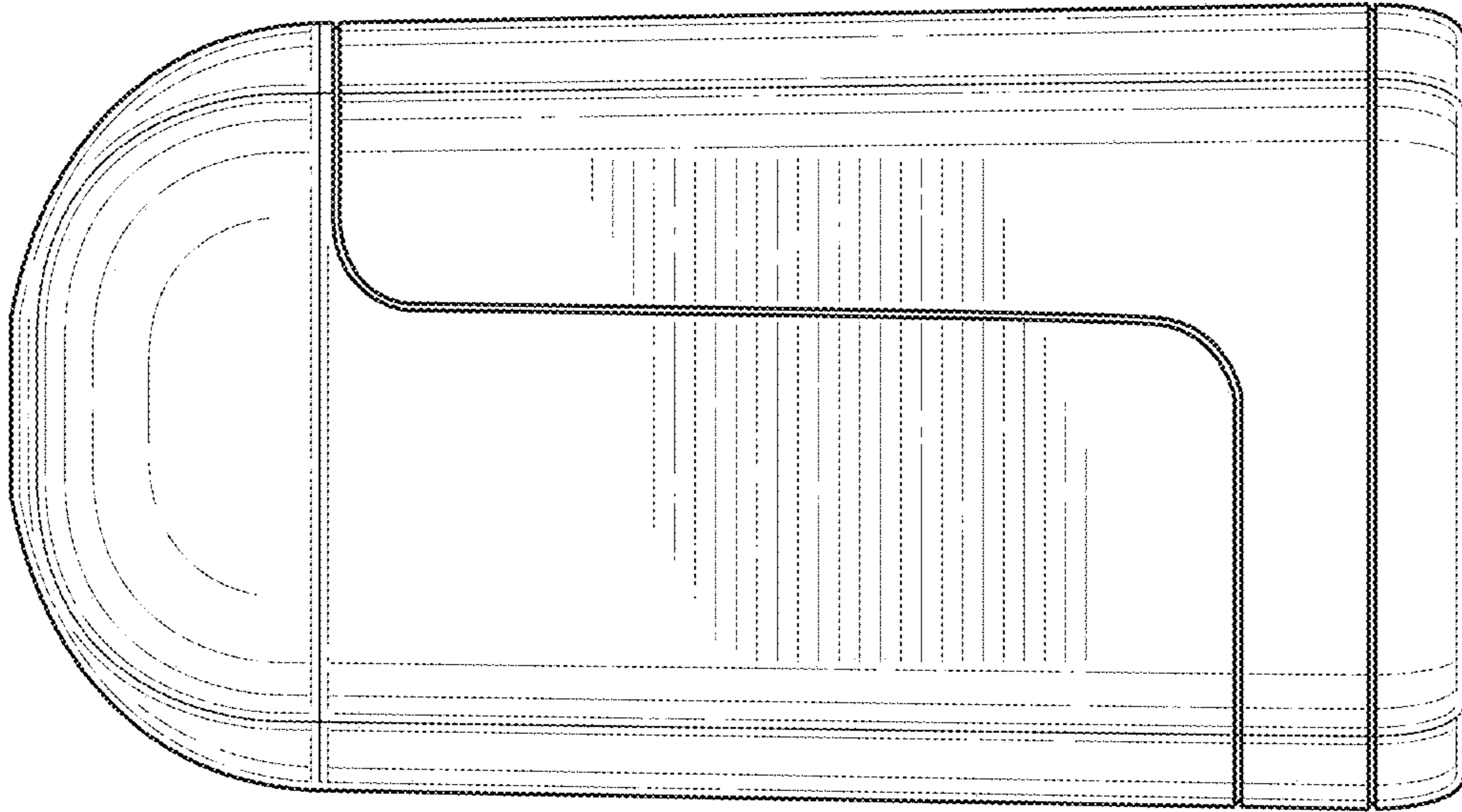

FIG. 4

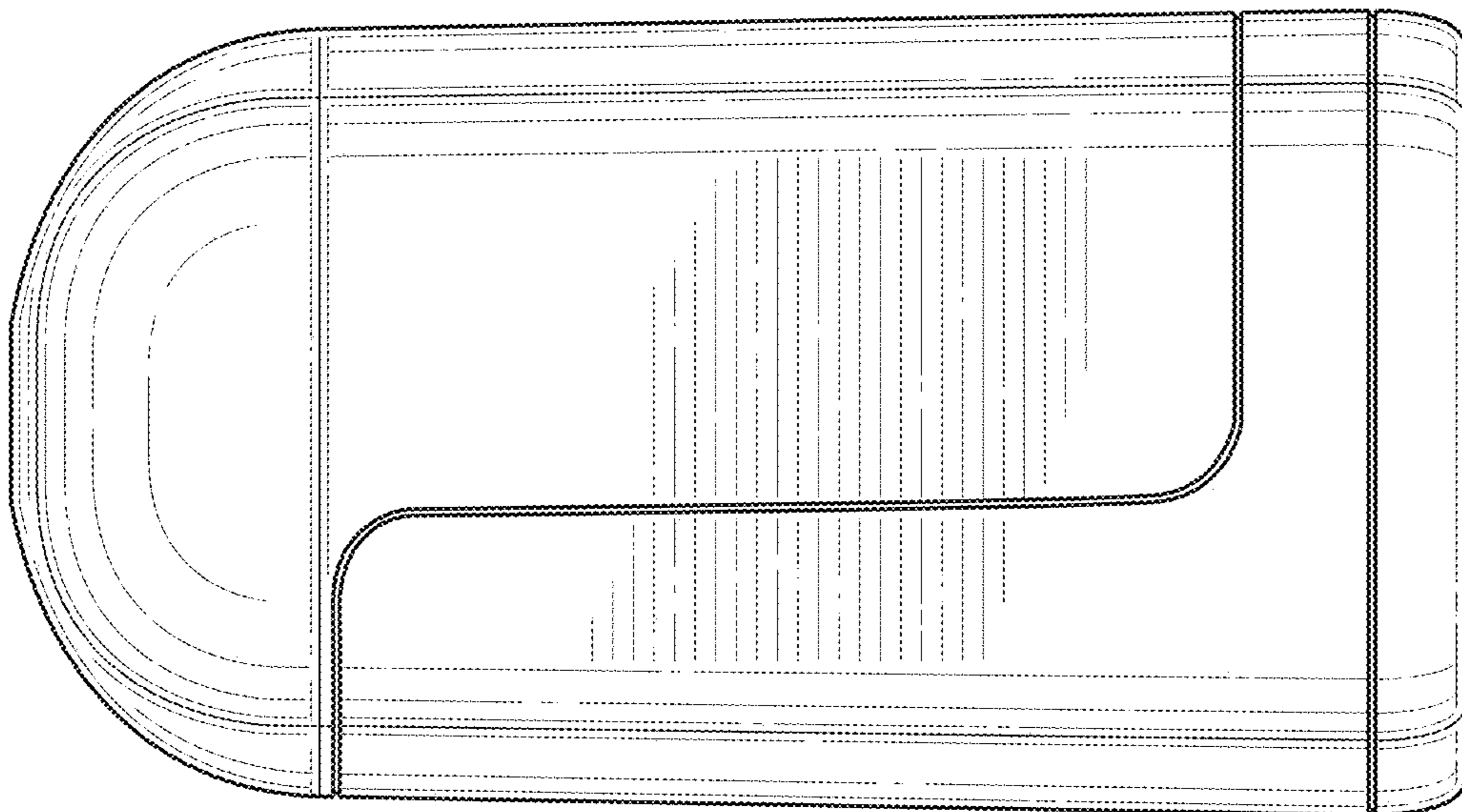

FIG. 3

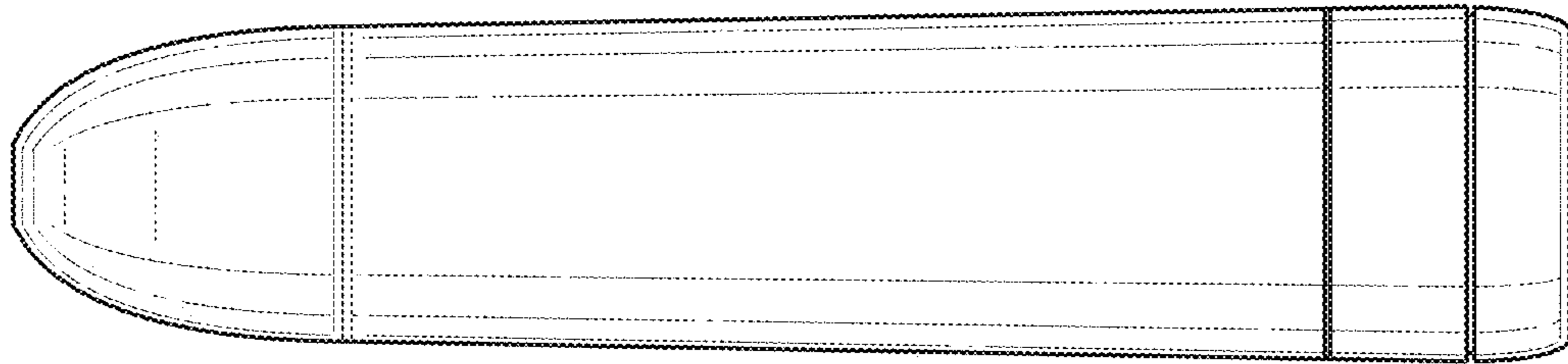

FIG. 6

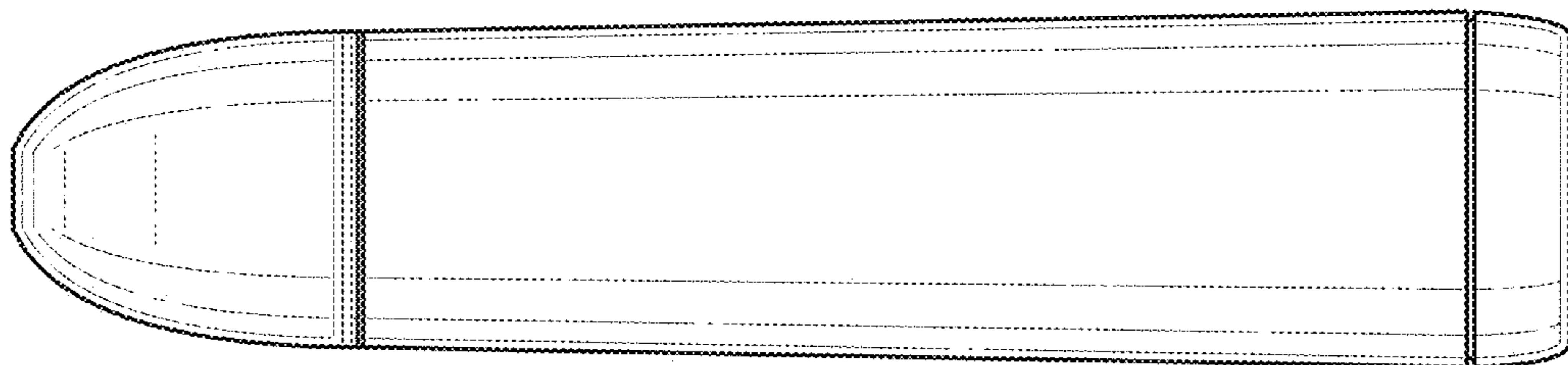

FIG. 5

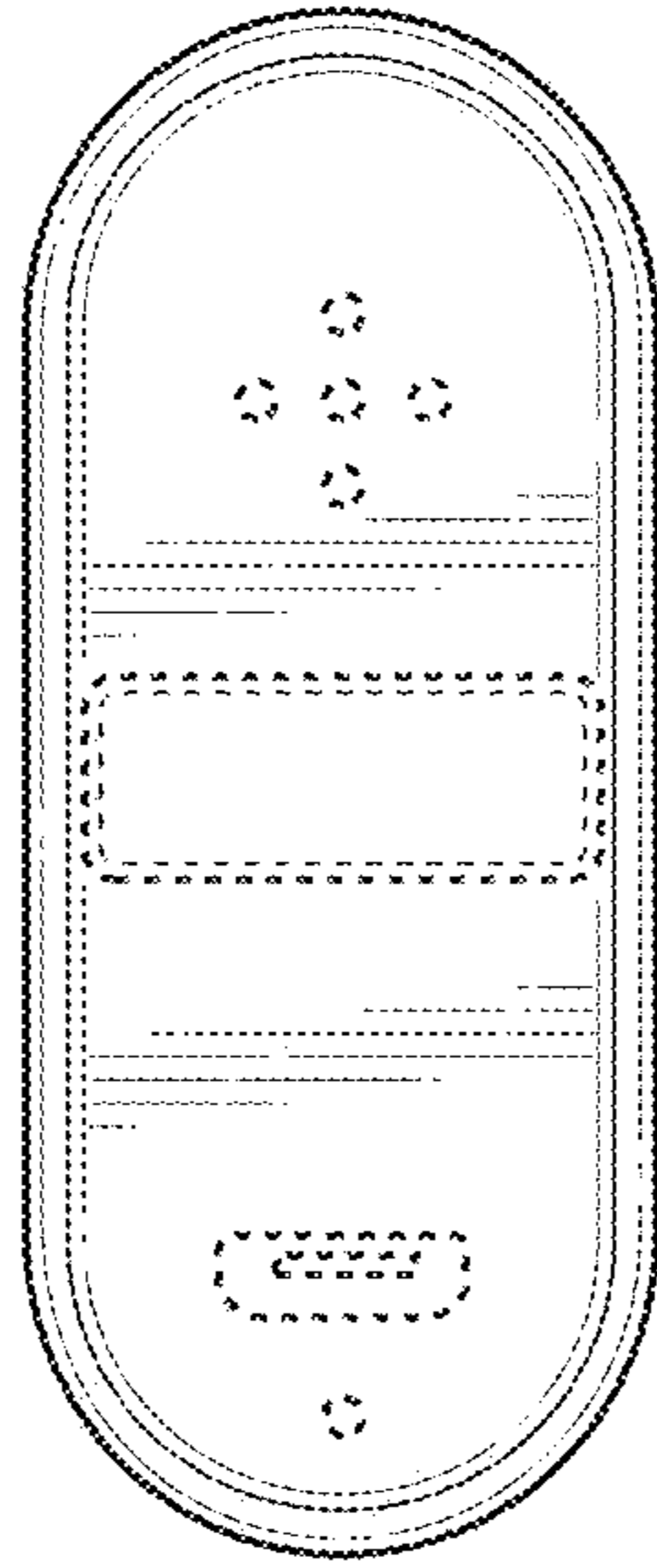

FIG. 8

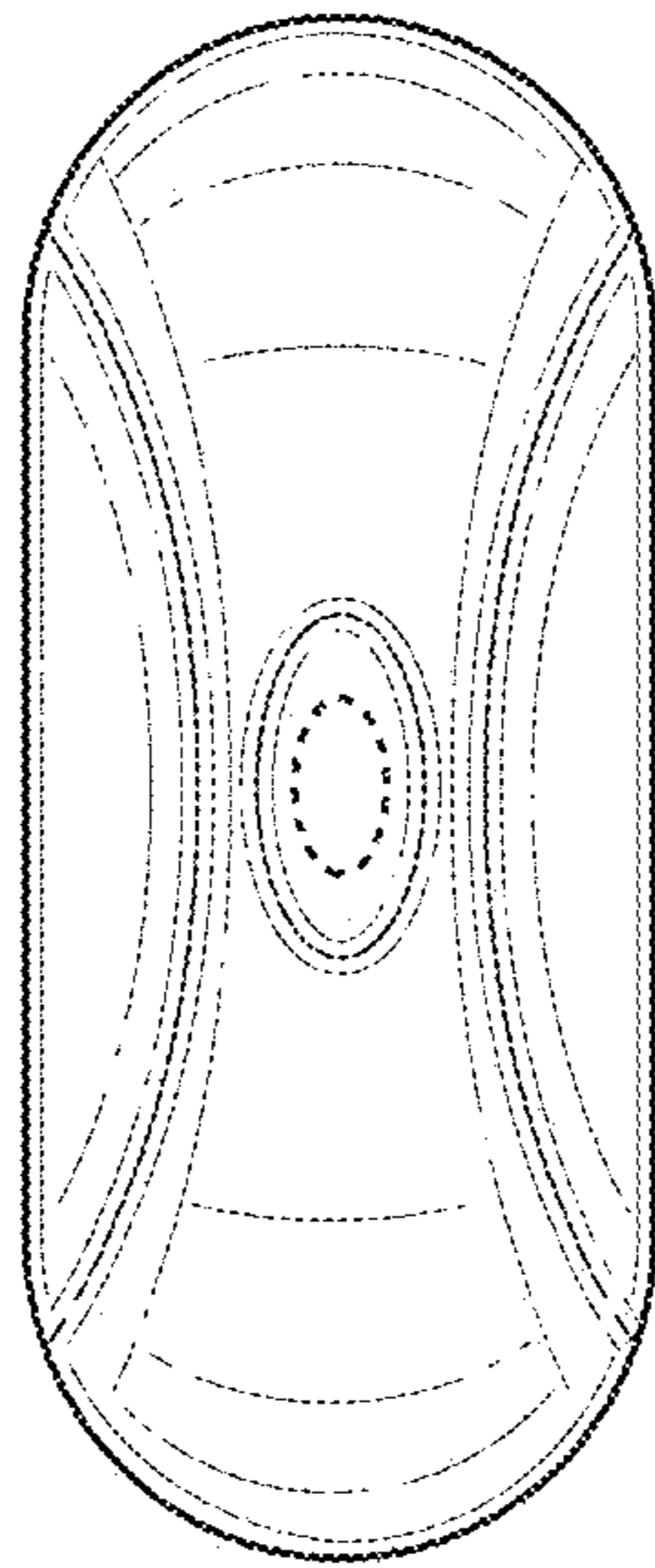

FIG. 7