



US00D941197S

(12) **United States Design Patent** (10) **Patent No.:** **US D941,197 S**
Wraith et al. (45) **Date of Patent:** **** Jan. 18, 2022**

(54) **VEHICLE FRONT UPPER GRILLE**

(71) Applicant: **Ford Global Technologies, LLC,**
Dearborn, MI (US)

(72) Inventors: **Paul Wraith,** West Bloomfield, MI (US); **Todd Willing,** East Melbourne (AU); **Dong Hoon Park,** Canton, MI (US); **Joseph F. Denatale,** Royal Oak, MI (US); **Alyssa Melotik,** Troy, MI (US)

(73) Assignee: **Ford Global Technologies, LLC,**
Dearborn, MI (US)

(**) Term: **15 Years**

(21) Appl. No.: **29/754,883**

(22) Filed: **Oct. 15, 2020**

(51) **LOC (13) Cl.** **12-16**

(52) **U.S. Cl.**
USPC **D12/163**

(58) **Field of Classification Search**
USPC D12/163, 169, 196, 86, 90-92; 180/68.1,
180/68.6; 293/193.11
CPC B62D 25/08; B62B 9/16; B60K 11/08;
B60R 19/52
See application file for complete search history.

(56) **References Cited**

U.S. PATENT DOCUMENTS

D703,586 S	*	4/2014	Platto	D12/98
D764,980 S	*	8/2016	Platto	D12/98
D769,160 S	*	10/2016	Platto	D12/163
D775,551 S	*	1/2017	Platto	D12/98
D809,428 S	*	2/2018	Platto	D12/98
D811,274 S	*	2/2018	Platto	D12/98
D821,920 S	*	7/2018	Platto	D12/91
D876,556 S	*	2/2020	Barajas	D21/561
D888,621 S	*	6/2020	Gittin, Jr.	D12/163
D906,188 S	*	12/2020	Wraith	D12/163

D906,189 S	*	12/2020	Wraith	D12/163
D906,190 S	*	12/2020	Wraith	D12/163
D919,494 S	*	5/2021	Wraith	D12/163
D919,495 S	*	5/2021	Wraith	D12/163
D919,496 S	*	5/2021	Wraith	D12/163
D933,548 S	*	10/2021	Willing	D12/163

OTHER PUBLICATIONS

Unknown, My observations from seeing see the actual 4-door Bronco raw, unpainted sheet metal shell, Feb. 15, 2020 <https://www.bronco6g.com/forum/threads/my-observations-from-seeing-see-the-actual-4-door-bronco-raw-unpainted-sheet-metal-shell.1048/>.

Unknown, Here's the 2021 Bronco's Tail Light Shape Illuminated, Feb. 19, 2020 <https://www.bronco6g.com/forum/threads/heres-the-2021-broncos-tail-light-shape-illuminated.1071/>.

(Continued)

Primary Examiner — Melody N Brown

(74) *Attorney, Agent, or Firm* — Michael Spenner

(57) **CLAIM**

The ornamental design for a vehicle front upper grille, as shown and described.

DESCRIPTION

FIG. 1 is a front elevational view of a vehicle front upper grille, showing our new design;
FIG. 2 is a left side elevational view thereof;
FIG. 3 is a right side elevational view thereof;
FIG. 4 is a top plan view thereof;
FIG. 5 is a bottom plan view thereof;
FIG. 6 is a top, front and left side perspective view thereof;
and,
FIG. 7 is a bottom, front and left side perspective view thereof.

The claimed design is indicated by the relatively dark portions in the figures. The de-emphasized and relatively light portions form no part of the claimed design.

1 Claim, 7 Drawing Sheets

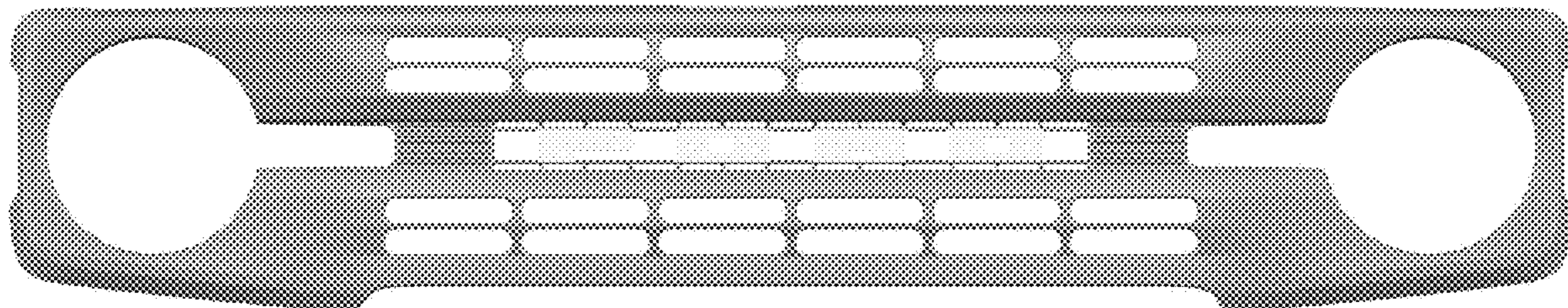

(56)

References Cited

OTHER PUBLICATIONS

Unknown, 2021 Bronco Interior Spied Undisguised!!, Feb. 25, 2020
<https://www.bronco6g.com/forum/threads/2021-bronco-interior-spied-undisguised.1096/>.

Arrian Padeanu, 2021 Ford Bronco Gets Five Adventure Concepts To Mark SUVs Birthday, Aug. 13, 2020 <https://www.motor1.com/news/438885/2021-ford-bronco-adventure-concepts>.

* cited by examiner

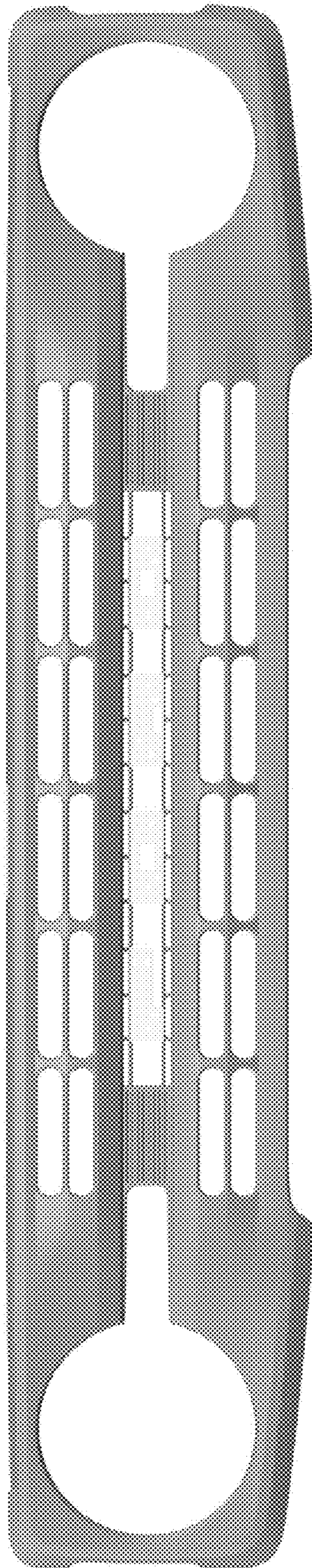

Fig.1

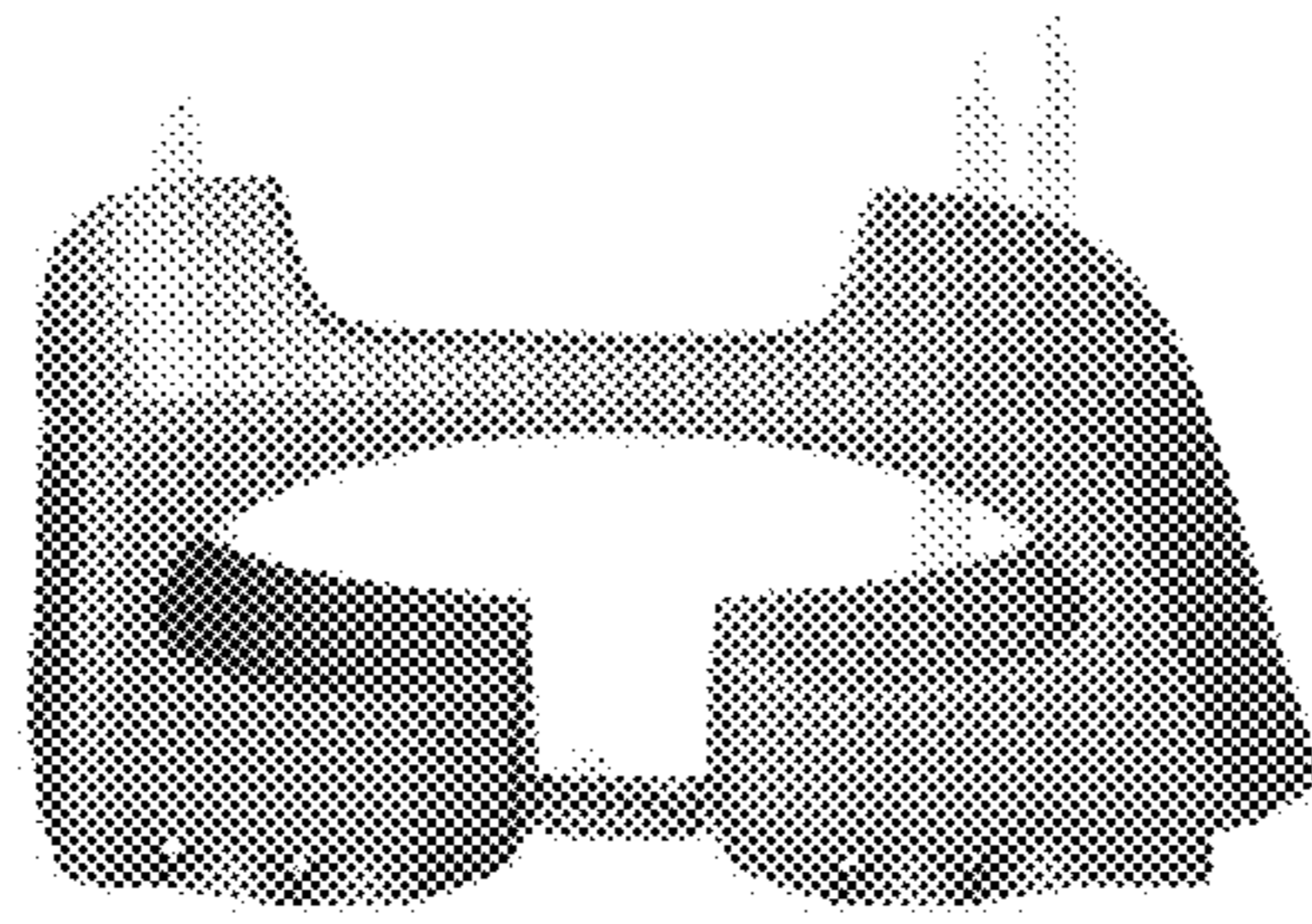

Fig. 2

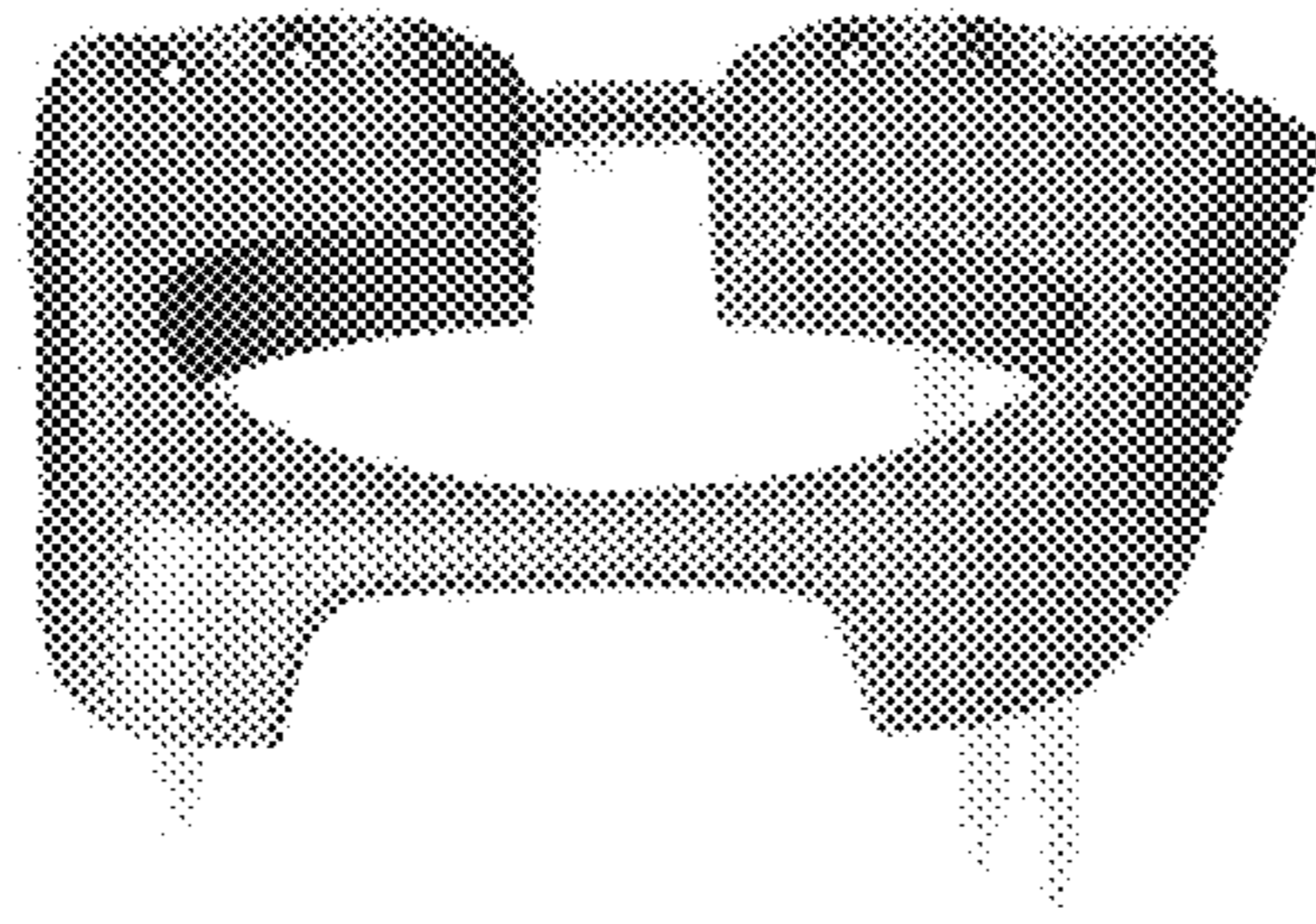

Fig. 3

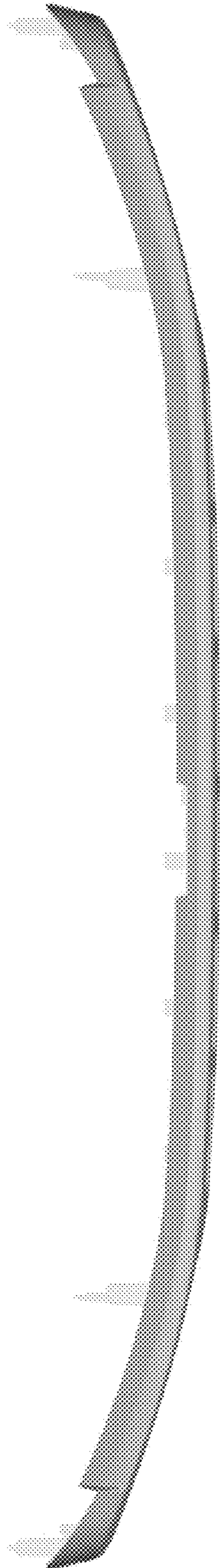

Fig.4

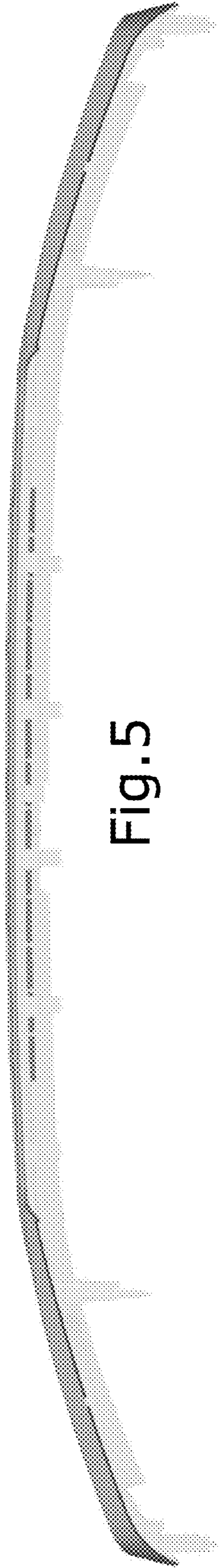

Fig. 5

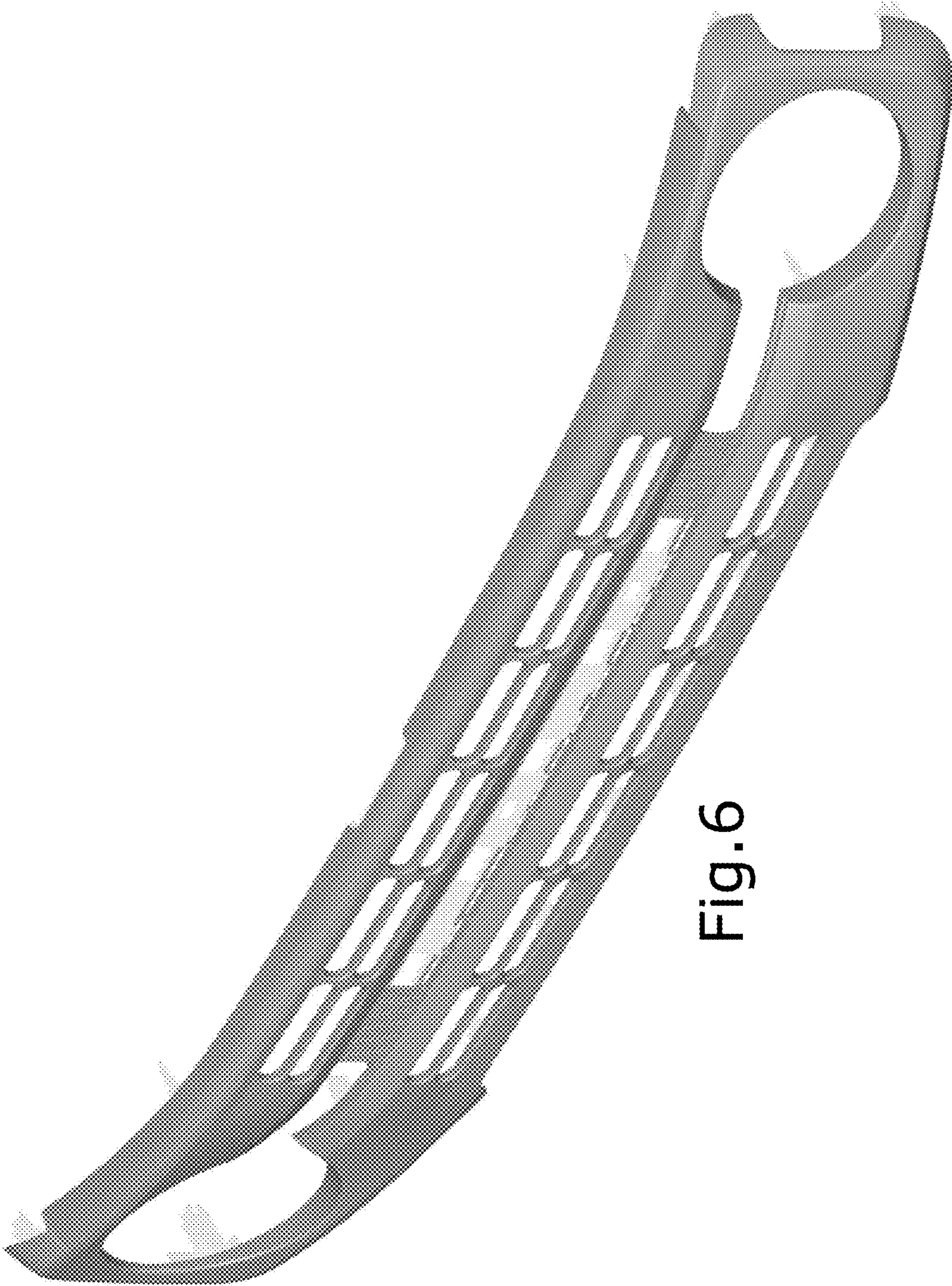

Fig. 6

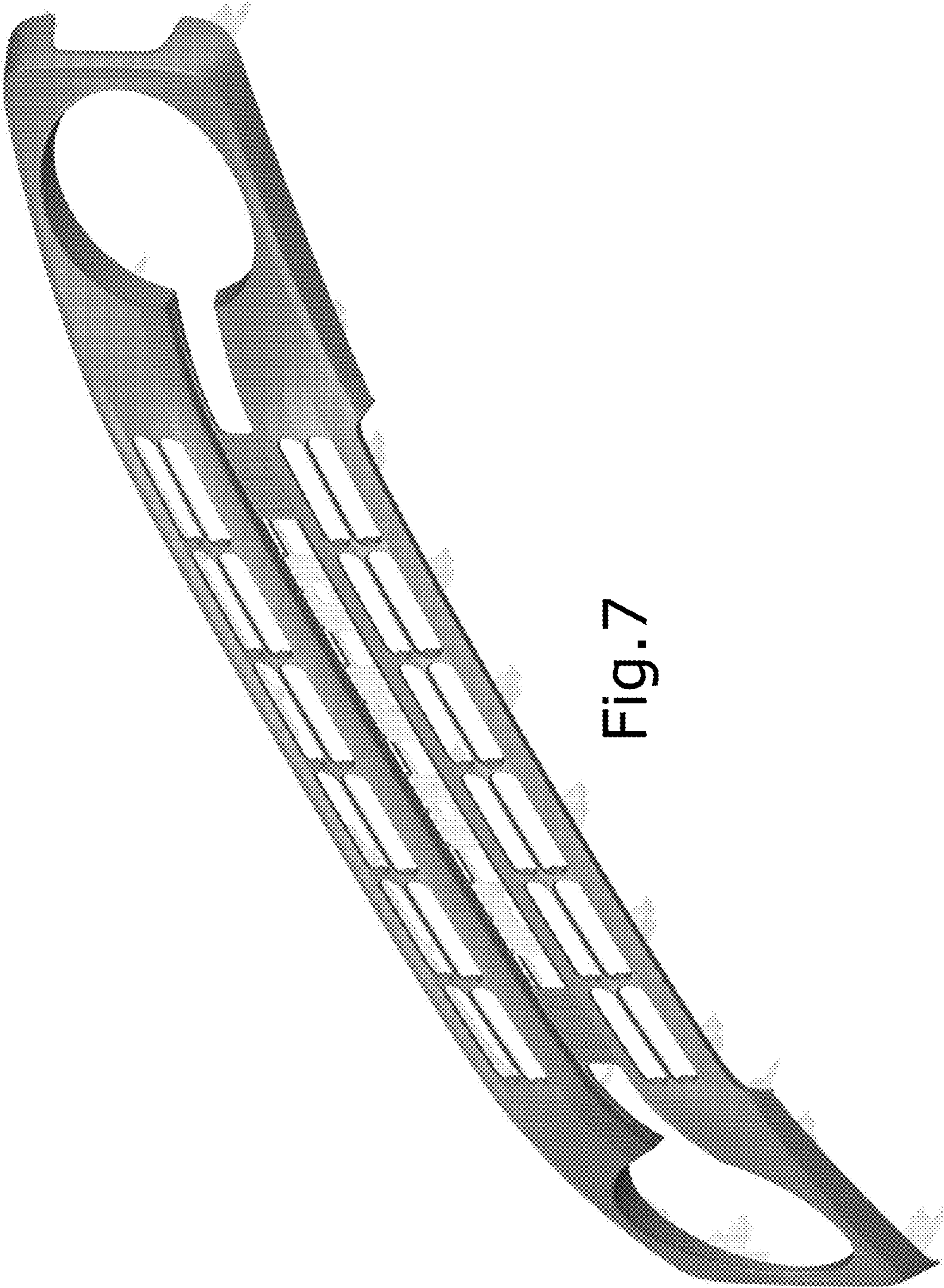

Fig. 7