

US00D941103S

(12) **United States Design Patent**
Skelton et al.

(10) **Patent No.:** **US D941,103 S**

(45) **Date of Patent:** **** Jan. 18, 2022**

- (54) **CAULK GUN TIP**
- (71) Applicants: **Robert Skelton**, St. James, NY (US);
Joseph Pagano, St. James, NY (US)
- (72) Inventors: **Robert Skelton**, St. James, NY (US);
Joseph Pagano, St. James, NY (US)
- (**) Term: **15 Years**
- (21) Appl. No.: **29/723,310**
- (22) Filed: **Feb. 5, 2020**
- (51) **LOC (13) Cl.** **08-05**
- (52) **U.S. Cl.**
USPC **D8/14.1; D8/45**
- (58) **Field of Classification Search**
USPC D8/14, 45; D9/435; D24/112, 214
CPC B05C 17/00516; E04F 21/1652; E04F
21/1655
See application file for complete search history.

D413,236 S	8/1999	Montigny	
D422,121 S *	3/2000	Peck	D29/114
D430,934 S	9/2000	Willard	
D441,627 S	5/2001	Hebert	
D443,488 S *	6/2001	Palladino	D8/14.1
D459,478 S *	6/2002	Perricone	D24/200
D468,601 S	1/2003	Horst	
D476,538 S *	7/2003	Dorff	D8/14.1
D487,896 S *	3/2004	Tanner, Jr.	D14/403
D503,232 S	3/2005	Semler et al.	
D529,236 S *	9/2006	Litke	D29/123
D534,773 S	1/2007	Tanaka	
D598,722 S	8/2009	Coll	
D606,375 S	12/2009	Divita	

(Continued)

Primary Examiner — Philip S Hyder
(74) *Attorney, Agent, or Firm* — Weber Rosselli & Cannon LLP

(57) **CLAIM**

The ornamental design for a caulk gun tip, as shown and described.

DESCRIPTION

FIG. 1 is a perspective view illustrating one embodiment of a caulk gun tip in accordance with the present design; FIG. 2 is a front view of the caulk gun tip of FIG. 1; FIG. 3 is a rear view of the caulk gun tip of FIG. 1; FIG. 4 is a first side view of the caulk gun tip of FIG. 1; FIG. 5 is a second side view of the caulk gun tip of FIG. 1; FIG. 6 is a top view of the caulk gun tip of FIG. 1; FIG. 7 is a bottom view of the caulk gun tip of FIG. 1; and, FIG. 8 is a perspective view illustrating a caulk gun tip in accordance with the present design attached to a caulk gun (shown in broken lines). The broken lines shown of the caulk gun and caulk tube in FIG. 8 are provided for purposes of environment and form no part of the claimed design.

1 Claim, 3 Drawing Sheets

(56) **References Cited**
U.S. PATENT DOCUMENTS

D251,953 S	5/1979	VanHorne	
D260,833 S *	9/1981	de Polo	D6/651
D260,866 S	9/1981	Richards	
D277,827 S	3/1985	Olsson	
D289,881 S	5/1987	Krumm	
D323,269 S	1/1992	Kelly et al.	
D332,901 S	2/1993	Campbell	
D333,955 S	3/1993	Hatgas et al.	
D353,239 S *	12/1994	Briscoe	D3/210
D360,720 S *	7/1995	Drevo	D3/211
D360,828 S	8/1995	Ball	
D365,830 S	1/1996	Hubbard et al.	
D371,494 S *	7/1996	Groene	D8/14.1
D377,891 S	2/1997	Bencich	
D400,326 S *	10/1998	Fisher	D32/42
D403,138 S *	12/1998	Wilmot	D29/117.2
D412,117 S	7/1999	Page	

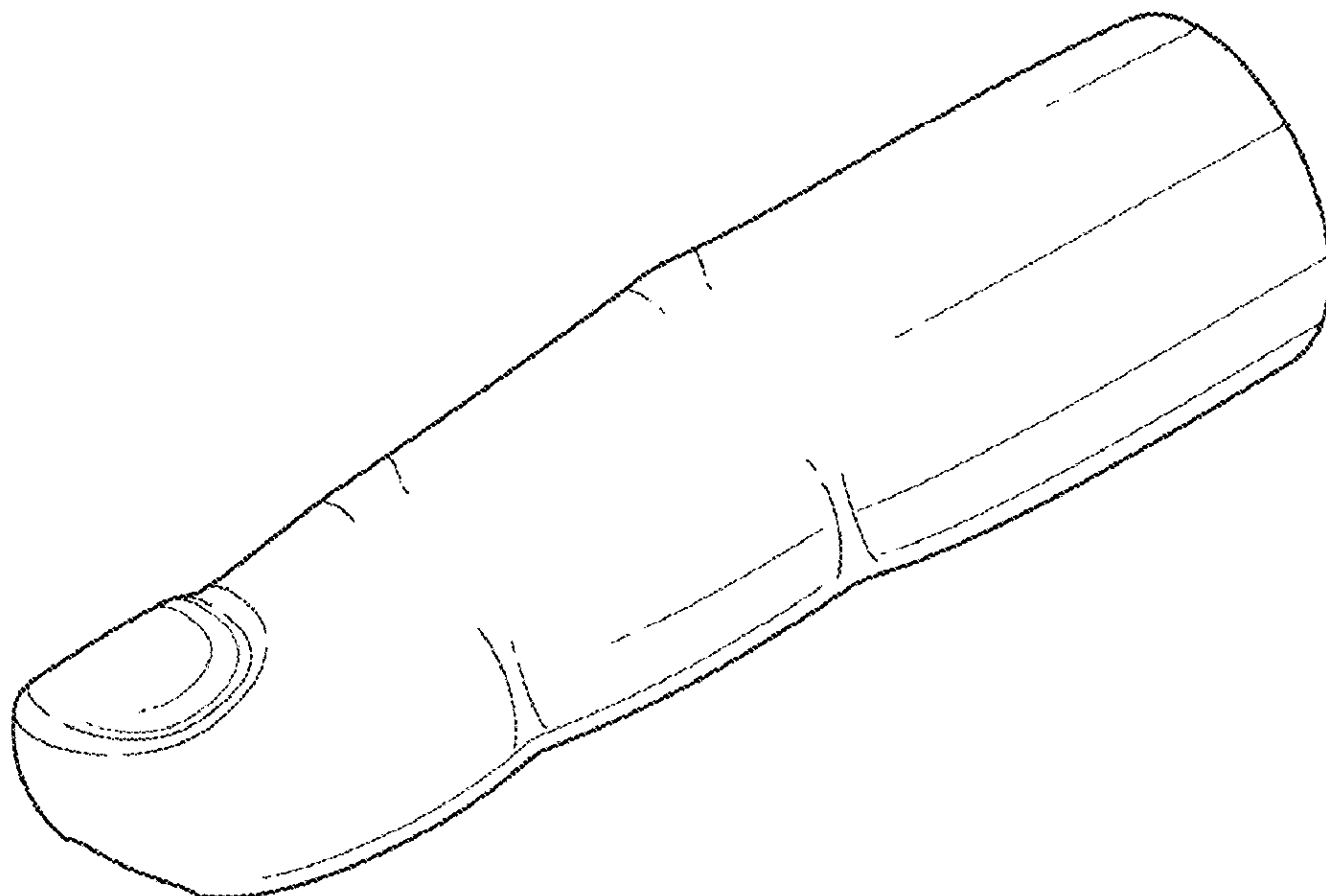

(56)

References Cited

U.S. PATENT DOCUMENTS

D627,821	S	11/2010	Patascher	
D634,600	S	3/2011	Gringer et al.	
D650,251	S	12/2011	Binder et al.	
D653,813	S *	2/2012	Rogers	D29/114
D660,106	S	5/2012	Cross	
D674,675	S	1/2013	Nash	
D677,535	S	3/2013	Scott	
D685,846	S	7/2013	Jiang	
D687,272	S	8/2013	Cross	
D696,006	S *	12/2013	Lee	D3/29
D718,102	S	11/2014	Cross	
D722,846	S	2/2015	Bacich	
D740,662	S	10/2015	Branham	
D864,685	S *	10/2019	Stephenson	D8/45
2014/0215676	A1 *	8/2014	Jones	A41D 13/087 2/21

* cited by examiner

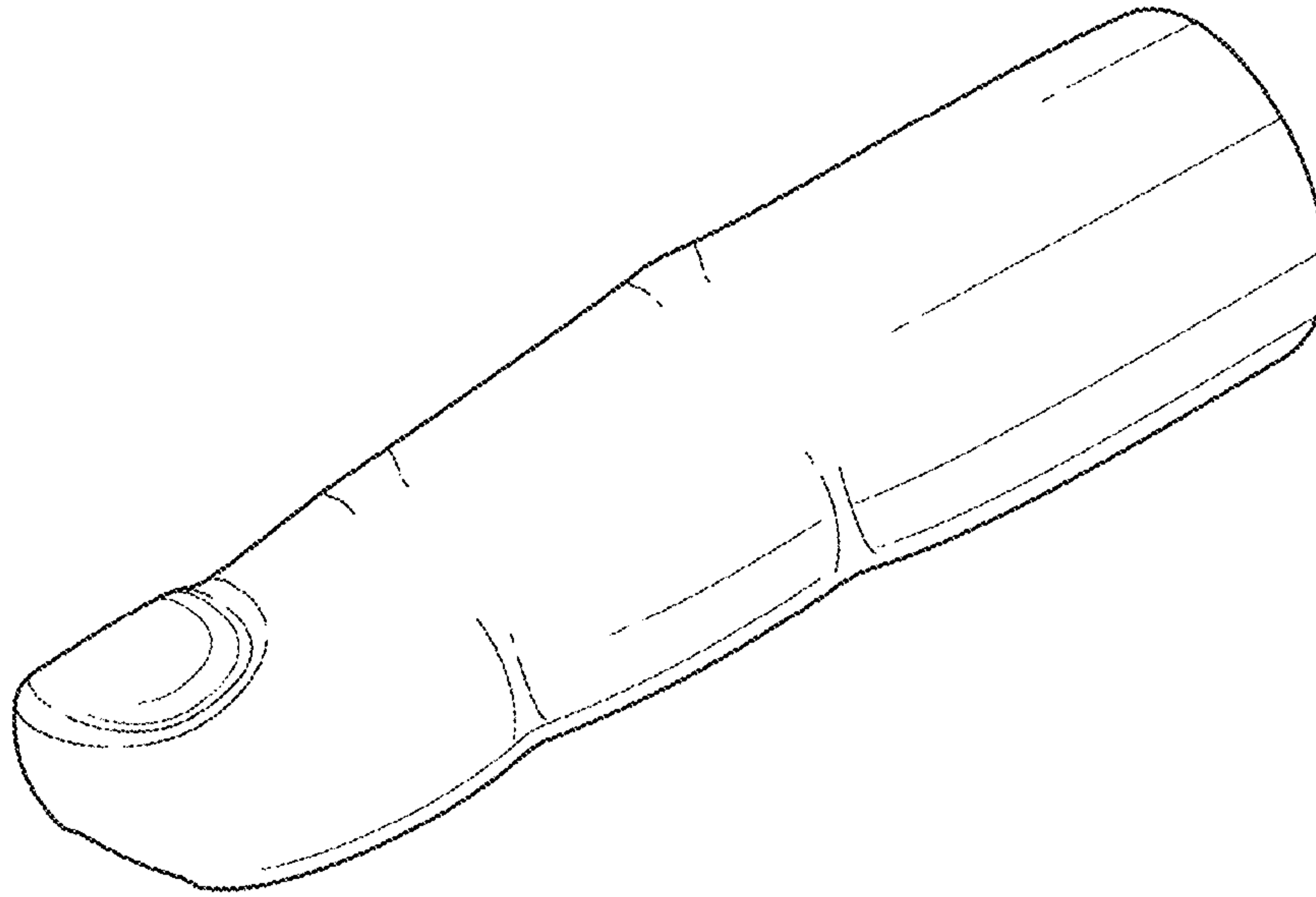

FIG. 1

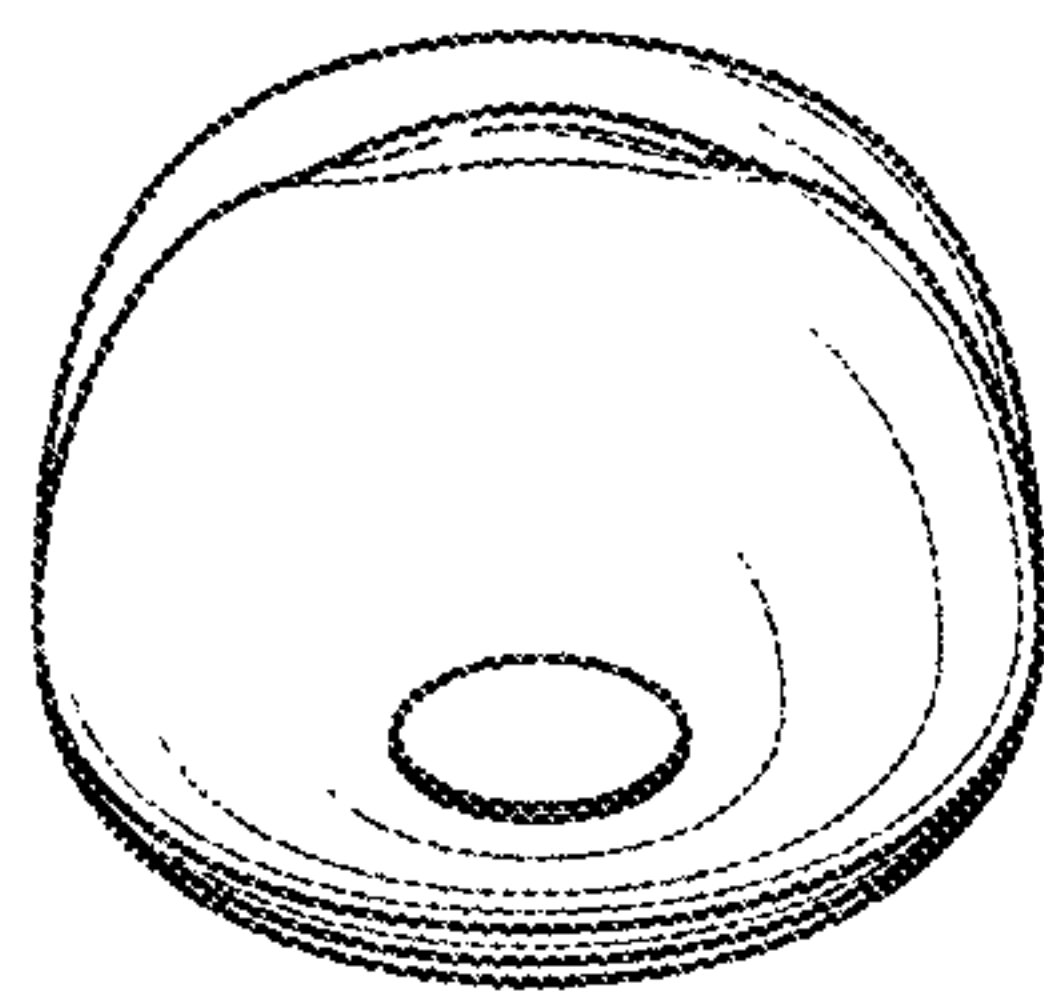

FIG. 2

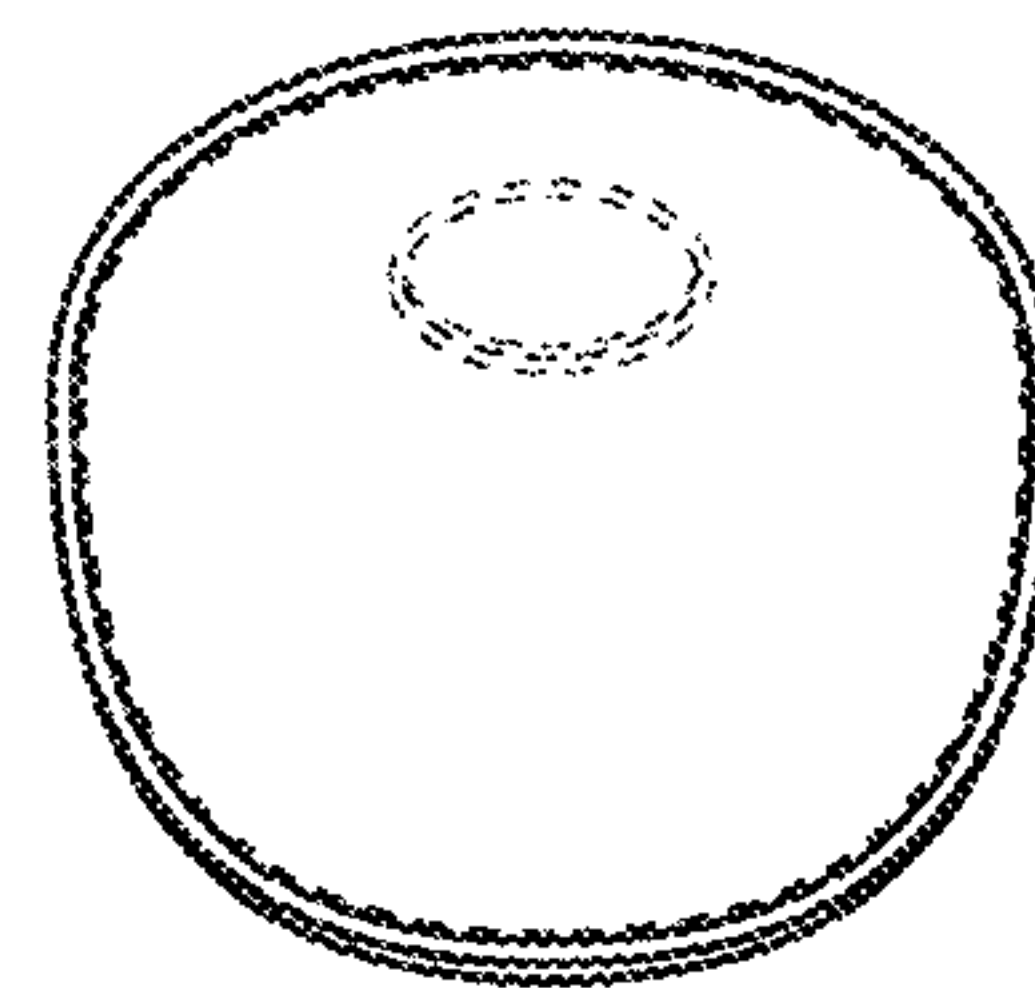

FIG. 3

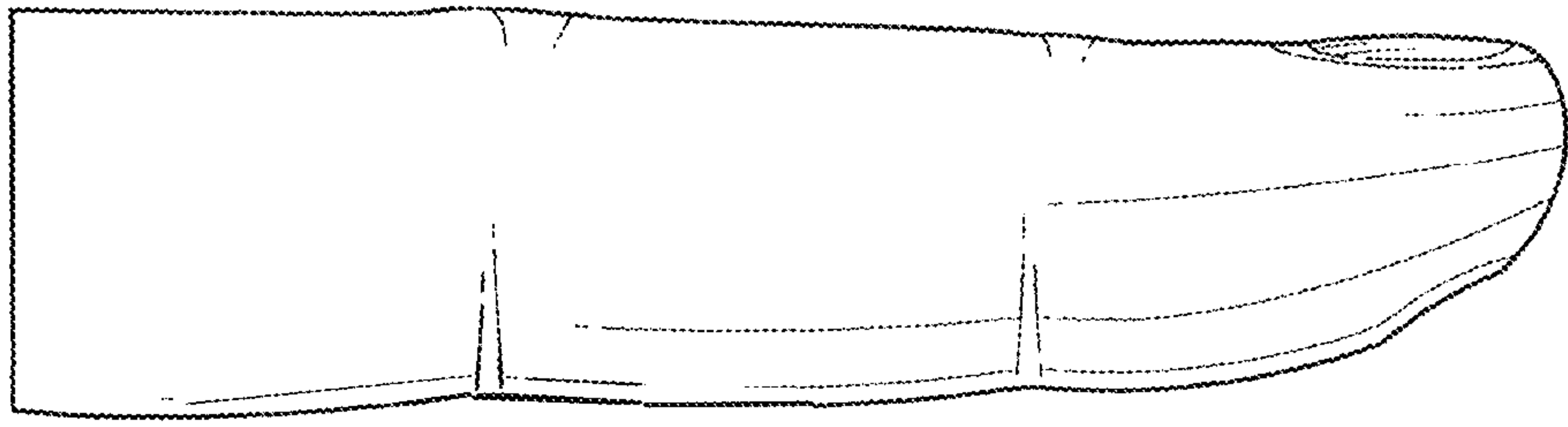

FIG. 4



FIG. 5

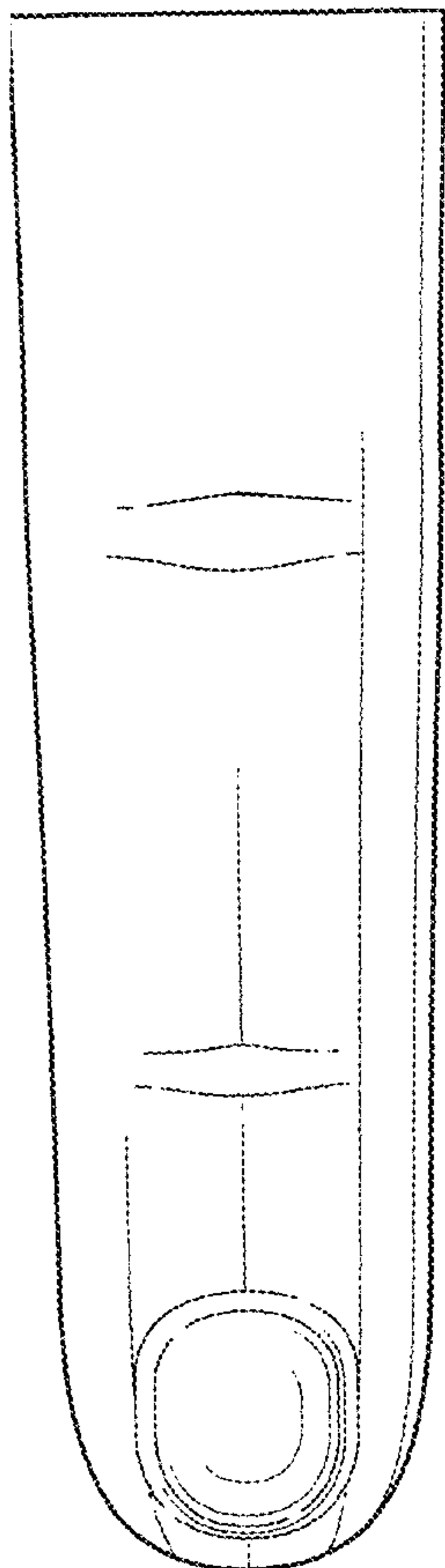

FIG. 6

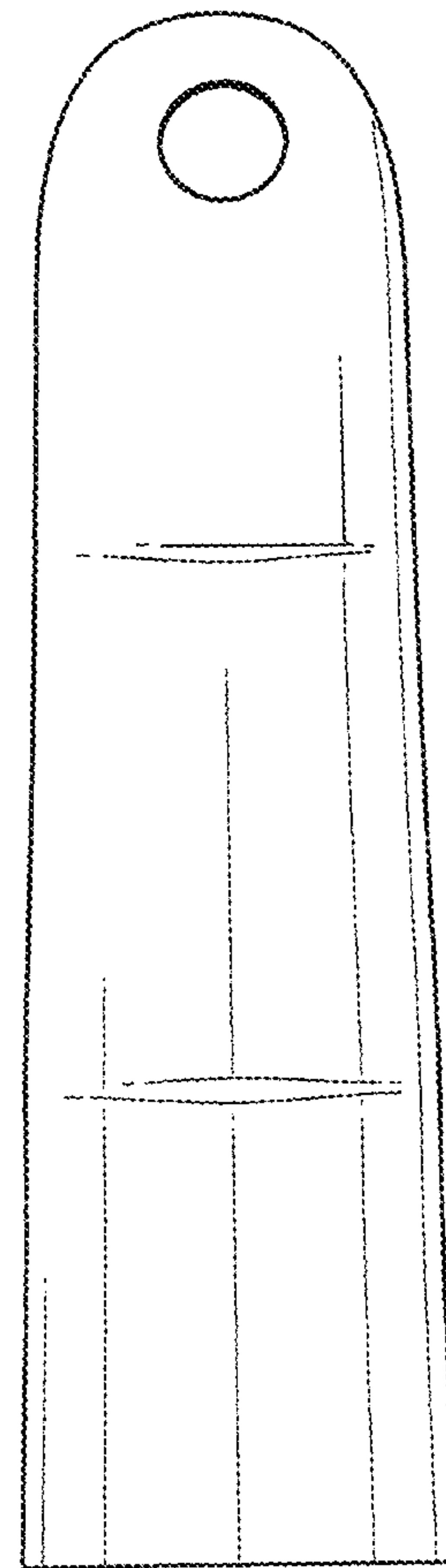

FIG. 7

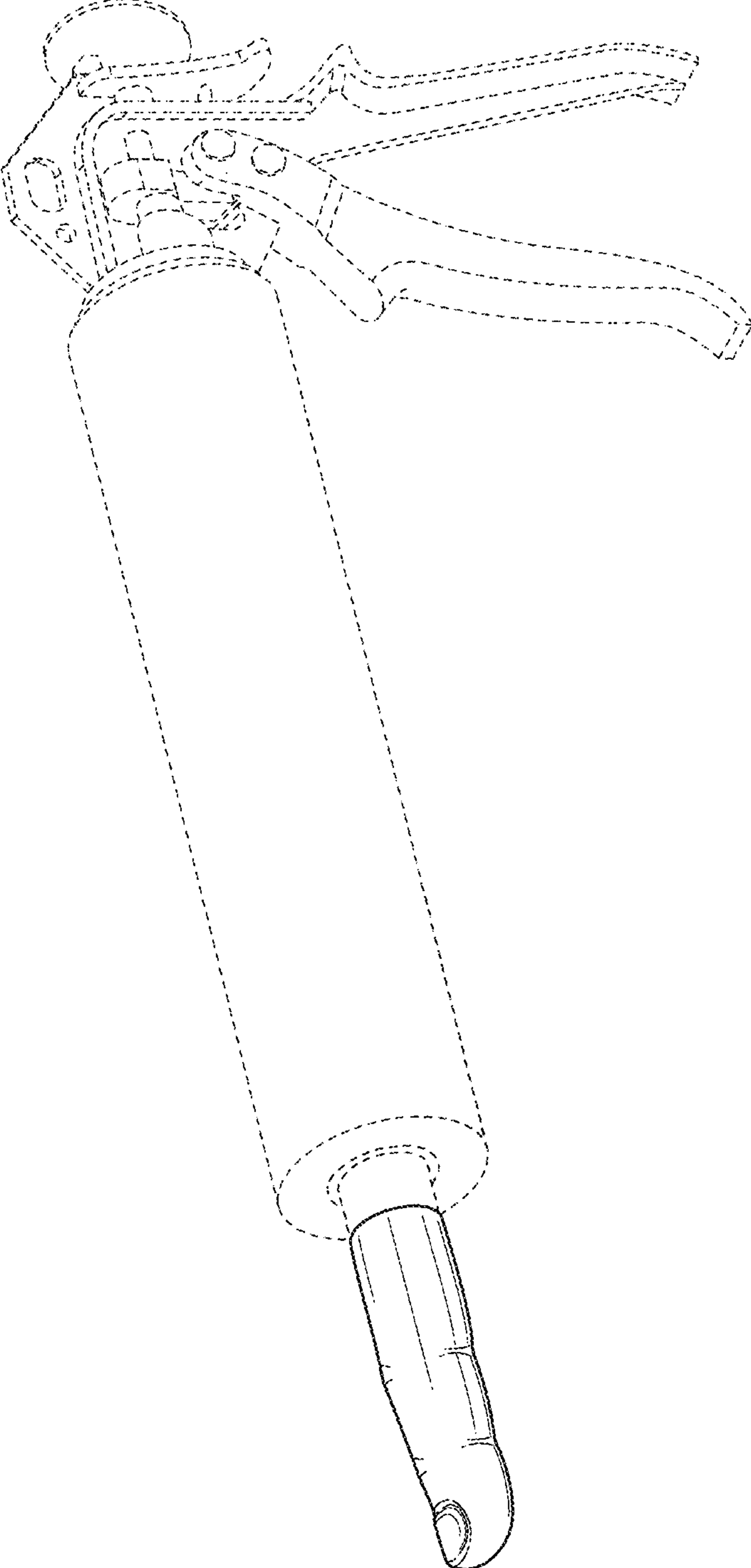

FIG. 8