



US00D941067S

(12) **United States Design Patent**
Velez

(10) **Patent No.:** **US D941,067 S**
(45) **Date of Patent:** **** Jan. 18, 2022**

- (54) **TABLE**
- (71) Applicant: **HOLLY HUNT ENTERPRISES, INC.**, Chicago, IL (US)
- (72) Inventor: **Alberto Velez**, Chicago, IL (US)
- (73) Assignee: **HOLLY HUNT ENTERPRISES, INC.**
- (**) Term: **15 Years**
- (21) Appl. No.: **29/710,343**
- (22) Filed: **Oct. 22, 2019**
- (51) **LOC (13) Cl.** **06-06**
- (52) **U.S. Cl.**
USPC **D6/707.18; D6/692.1**
- (58) **Field of Classification Search**
USPC ... D6/349, 685, 686, 690, 692, 692.1-692.6,
D6/707, 707.18, 707.2
CPC A47B 7/00; A47B 13/00; A47B 13/003;
A47B 13/02; A47B 13/023; A47B 13/04;
A47B 13/06; A47B 13/08; A47B 13/01;
A47B 13/12; A47B 2013/024; A47B
21/00; A47B 2200/0001; A47B
2200/0011; A47B 2200/002; A47B
2200/0021
See application file for complete search history.

- D527,551 S * 9/2006 Berry D6/687
- 7,107,914 B2 * 9/2006 Sherman A47B 13/088
108/64
- D539,579 S * 4/2007 Elko D21/397
(Continued)

OTHER PUBLICATIONS

Holly Hunt website, <https://www.hollyhunt.com/ShowProduct.aspx?ProductID=6122&ManufacturerID=1>, retrieved Oct. 22, 2019, pp. 1.

(Continued)

Primary Examiner — Mary Ann Calabrese
(74) *Attorney, Agent, or Firm* — The Belles Group, P.C.

(57) **CLAIM**

The ornamental design for a table, as shown and described.

DESCRIPTION

FIG. 1 is a front perspective view of a table according to a first embodiment of the new design;
FIG. 2 is a rear perspective view thereof;
FIG. 3 is a right side view thereof;
FIG. 4 is a left side view thereof;
FIG. 5 is a rear view thereof;
FIG. 6 is a front view thereof;
FIG. 7 is a top view thereof;
FIG. 8 is a bottom view thereof;
FIG. 9 is a front perspective view of a table according to a second embodiment of the new design;
FIG. 10 is a rear perspective view thereof;
FIG. 11 is a right side view thereof;
FIG. 12 is a left side view thereof;
FIG. 13 is a rear view thereof;
FIG. 14 is a front view thereof;
FIG. 15 is a top view thereof; and,
FIG. 16 is a bottom view thereof.
The broken lines illustrate portions of the table that form no part of the claimed design.

(56) **References Cited**
U.S. PATENT DOCUMENTS

- 2,332,291 A 10/1943 Binz
- D143,454 S * 1/1946 White D6/687
- D254,825 S * 4/1980 Crespi D6/692.3
- D254,826 S * 4/1980 Crespi D6/692.3
- D274,578 S * 7/1984 Berry, Jr. D6/692.3
- D284,336 S * 6/1986 Berry, Jr. D6/687
- D292,250 S * 10/1987 Finkelstein D6/687
- D415,634 S * 10/1999 Lin A47B 13/088
D6/692.3
- D431,939 S 10/2000 Risdall

1 Claim, 16 Drawing Sheets

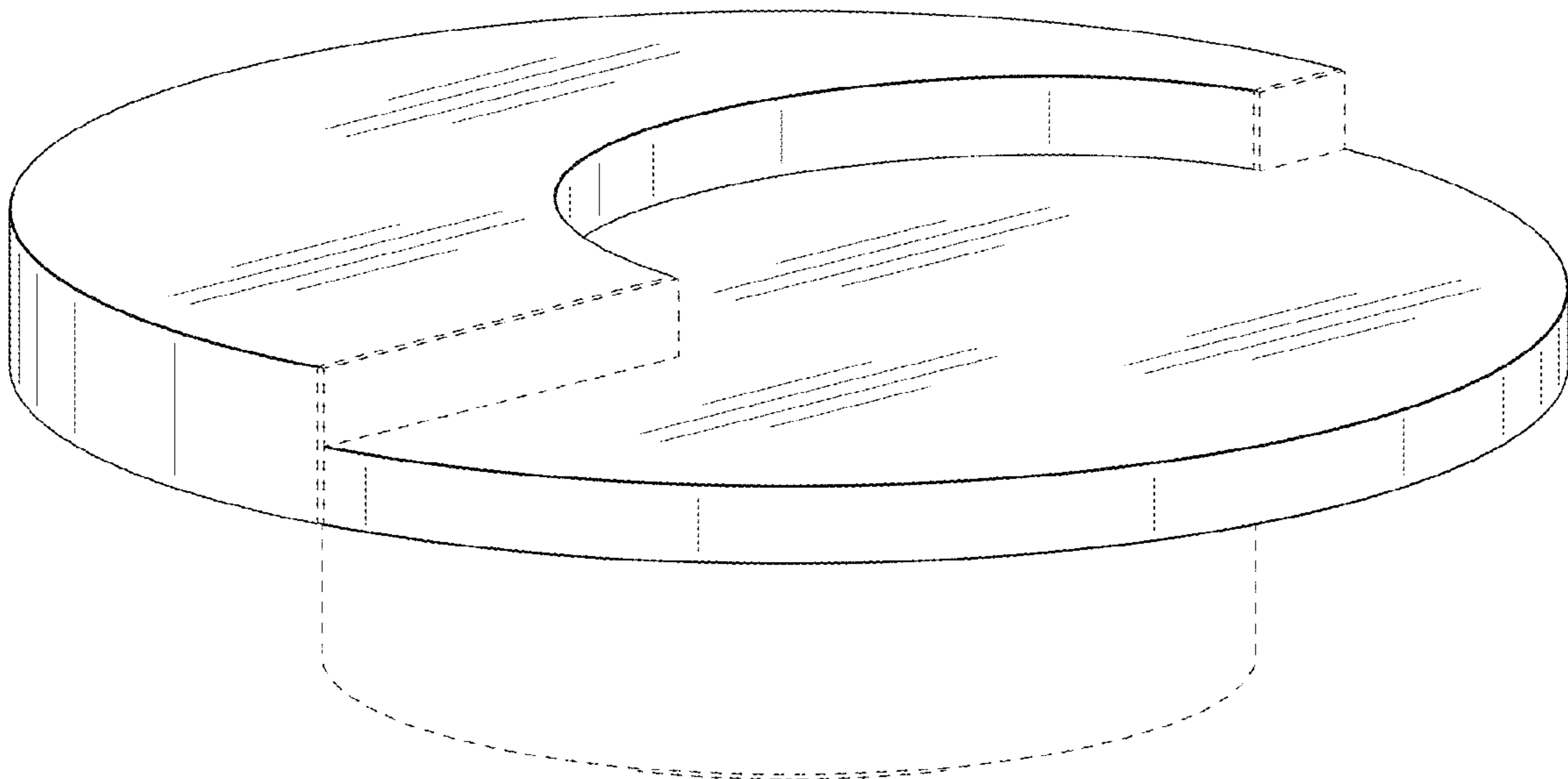

(56)

References Cited

U.S. PATENT DOCUMENTS

D778,088 S * 2/2017 Hiyoshi D6/691
D799,867 S * 10/2017 Thai D6/692.3
D915,807 S * 4/2021 Kimmel D6/692.3

OTHER PUBLICATIONS

Holly Hunt website, <https://www.hollyhunt.com/ShowProduct.aspx?ProductID=21151&ManufacturerID=1>, retrieved Oct. 22, 2019, pp. 1.

Holly Hunt website, <https://www.hollyhunt.com/ShowProduct.aspx?ProductID=10682&ManufacturerID=1>, retrieved Oct. 22, 2019, pp. 1.

CRATE & BARREL website, https://www.crateandbarrel.com/revolve-48-round-adjustable-height-dining-table/s672566?localedetail=US&storeid=643&a=1552&campaignid=880315824&adgroupid=42649983725&targetid=aud-339257671401:pla-425837906566&pla_sku=672566&pcat=FURN&ag=adult&gclid=Cj0KCQjwoqDtBRD-ARIsAL4pviDbPSdP1my8sLVQcoODtc71dphJOkLfEToeD6peAatHvHolmFvSVeYaApYdEALw_wcB, retrieved Oct. 22, 2019, pp. 1-2.

Aliexpress website, <https://www.aliexpress.com/item/32283237669.html>, retrieved Oct. 22, 2019, pp. 1-11.

Davis Quality Furniture website, <https://davisqualityfurniture.net/products/henredon-furniture-1945-gugenheim-dark-walnut-crescent-occasional-table-2203-42>, retrieved Oct. 22, 2019, pp. 1-4.

Modish Store website, <https://www.modishstore.com/products/vigfurniture-modrest-bascom-modern-walnut-end-table-w-swivel-top>, retrieved Oct. 22, 2019, pp. 1-6.

* cited by examiner

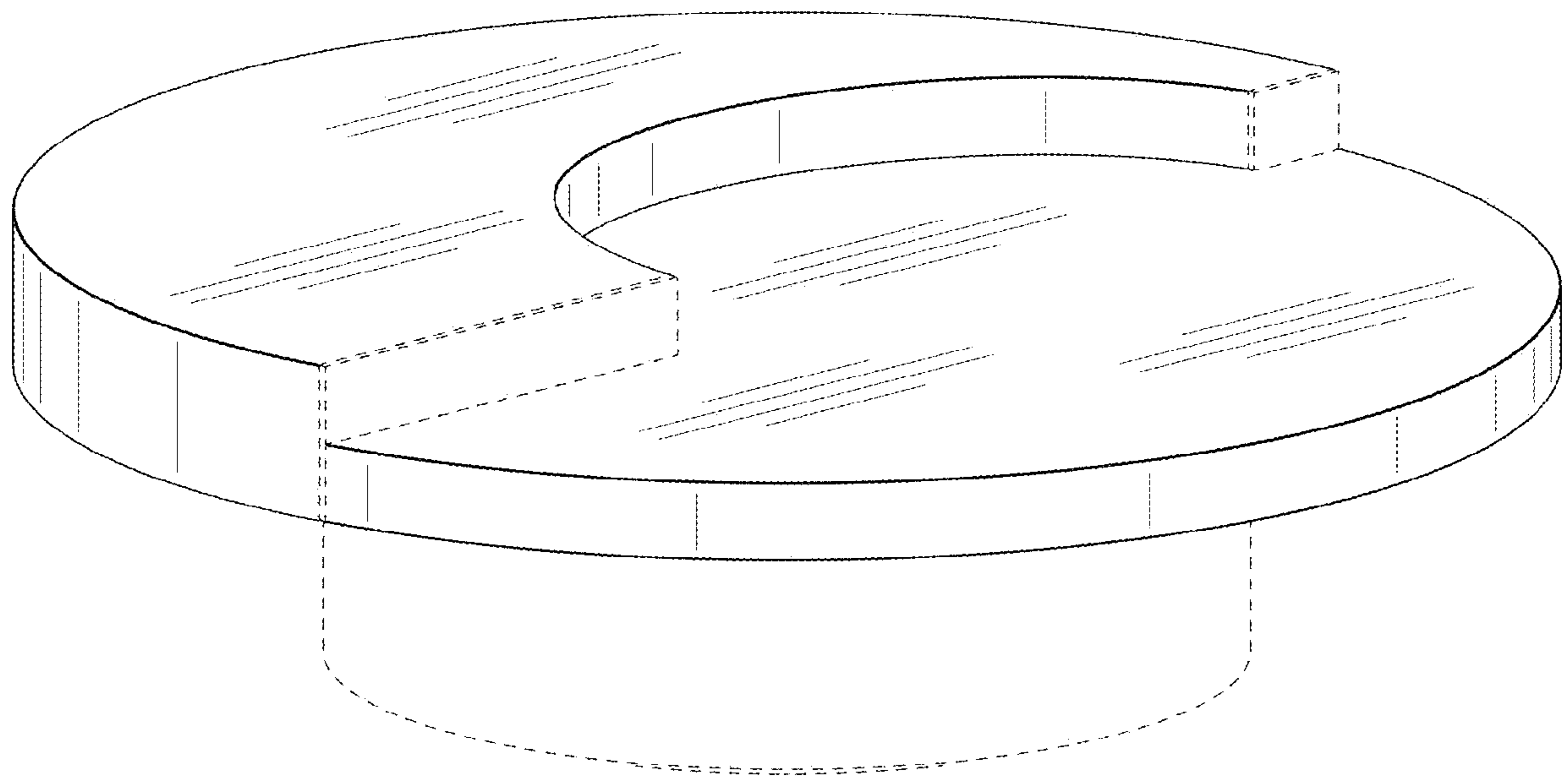

FIG. 1

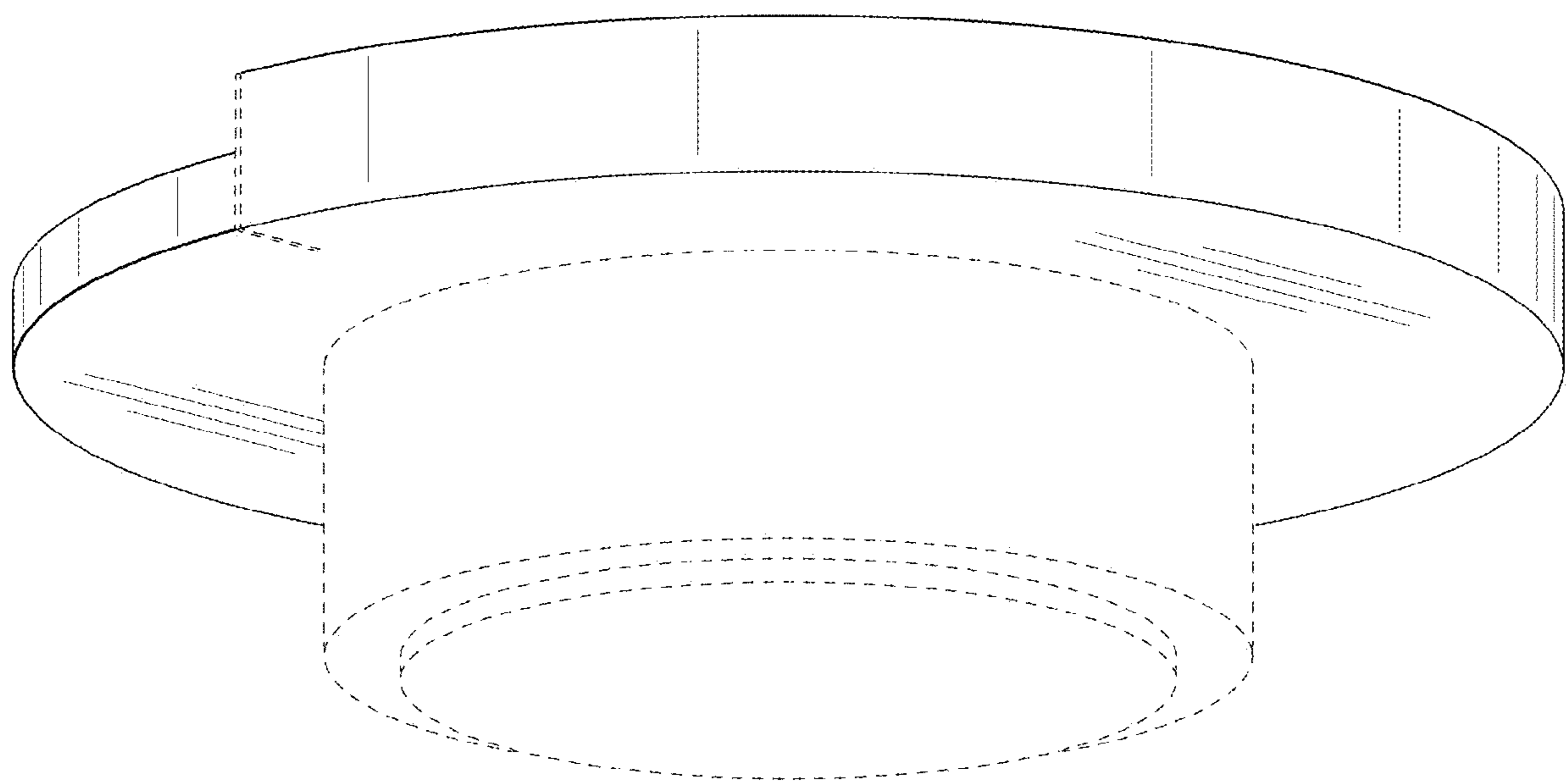

FIG. 2

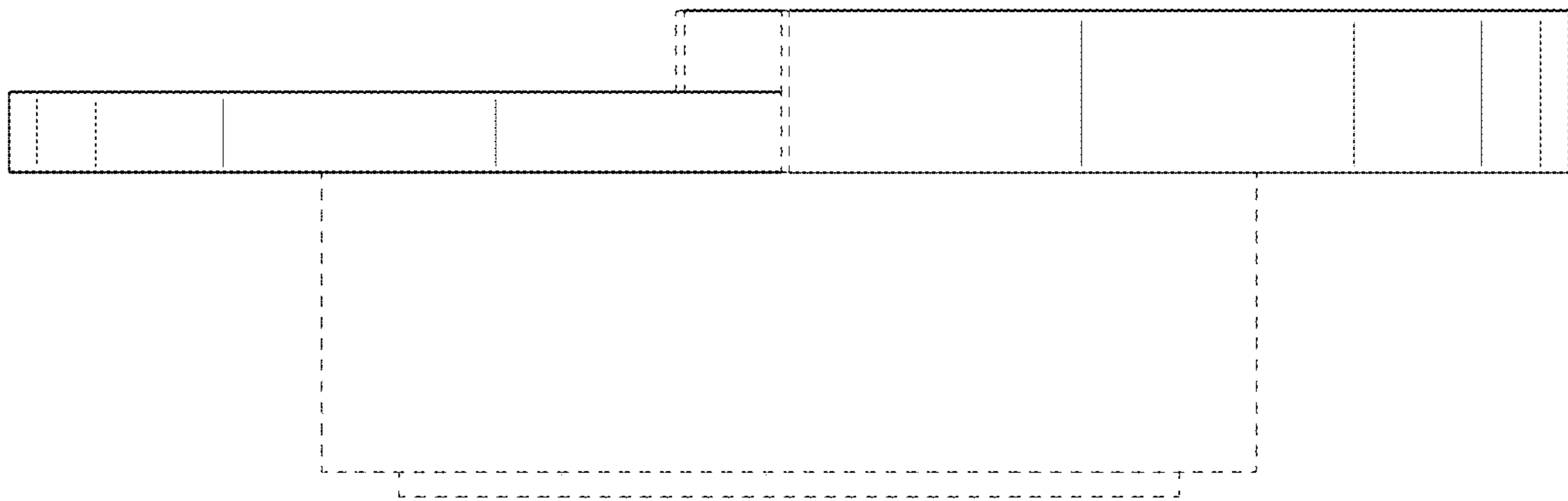

FIG. 3

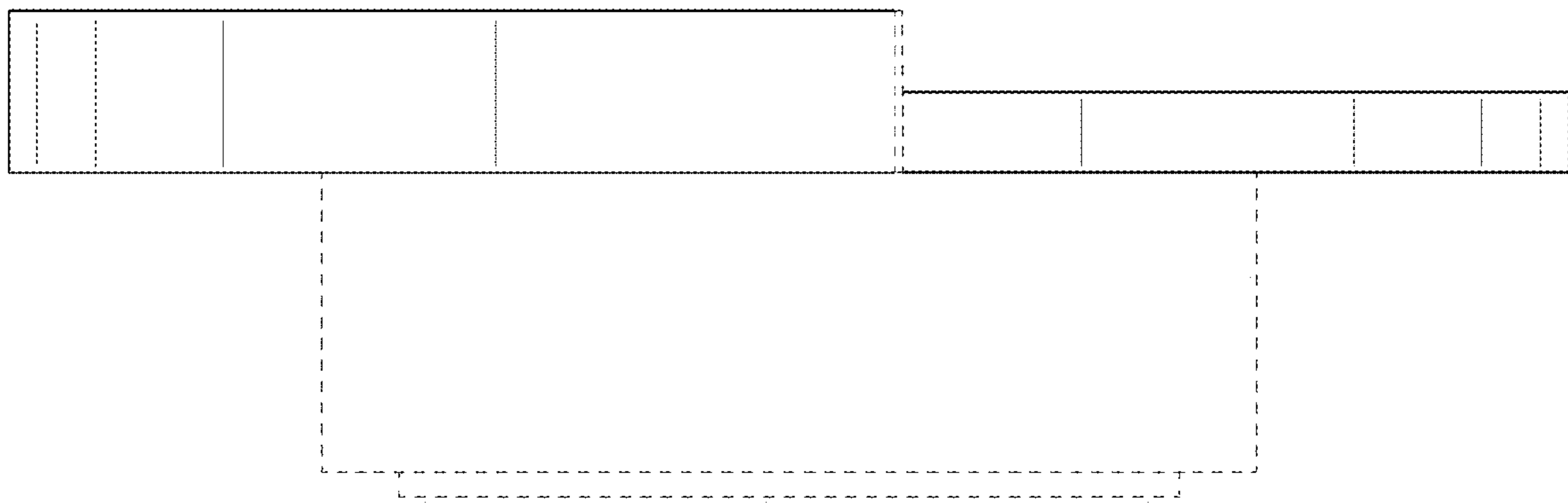

FIG. 4

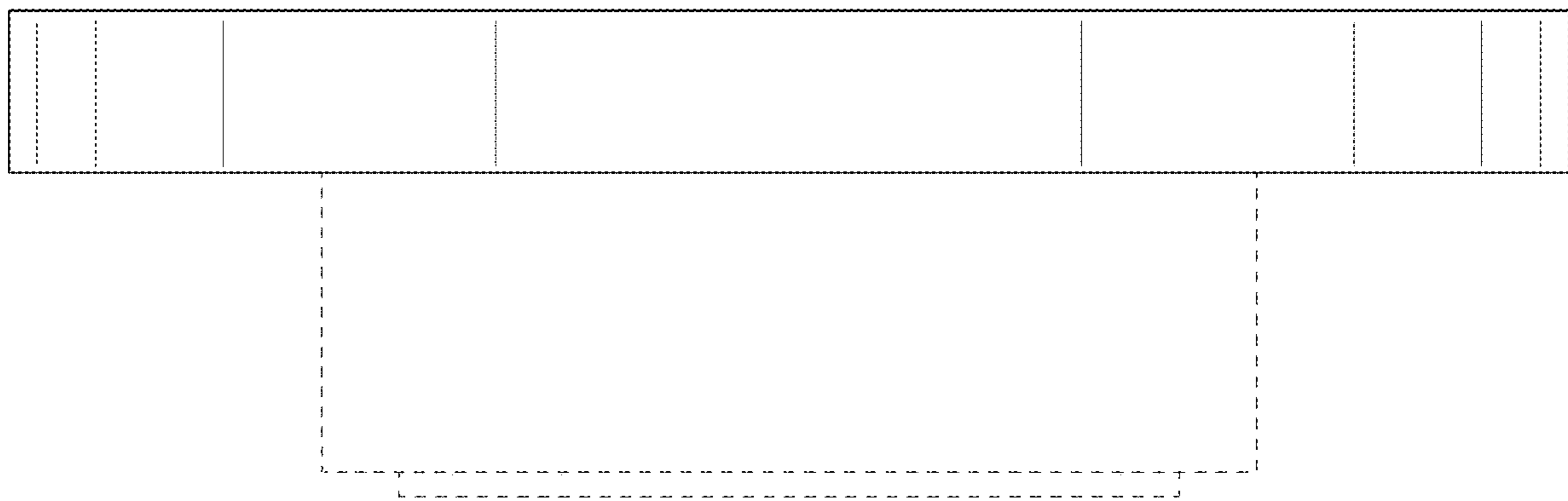

FIG. 5

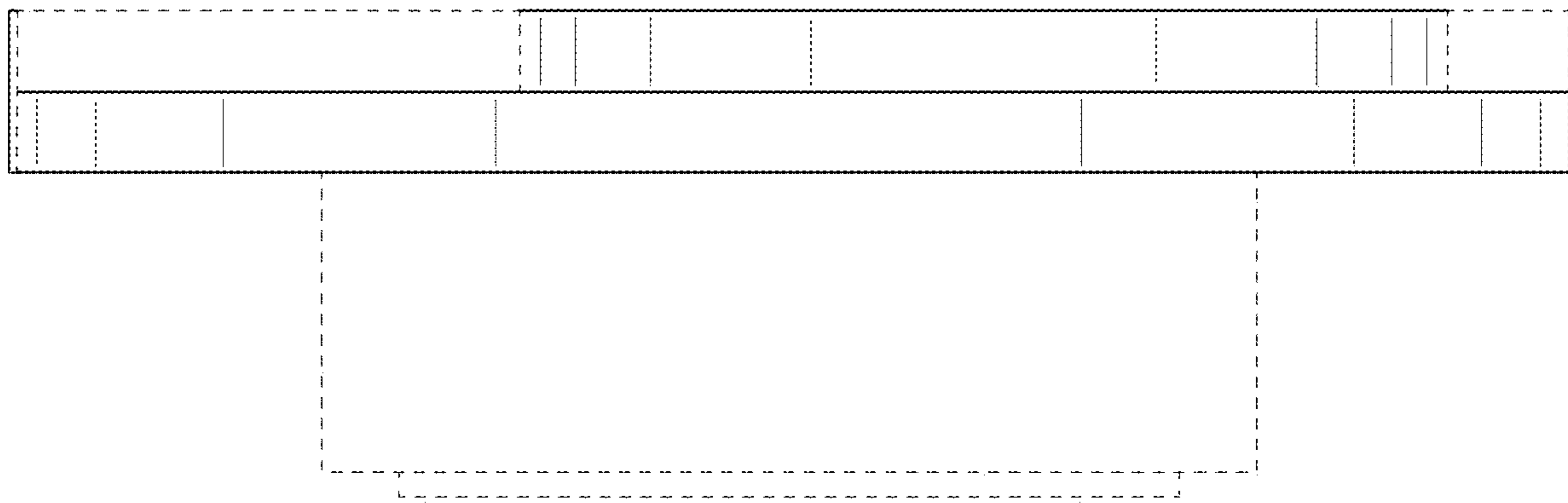

FIG. 6

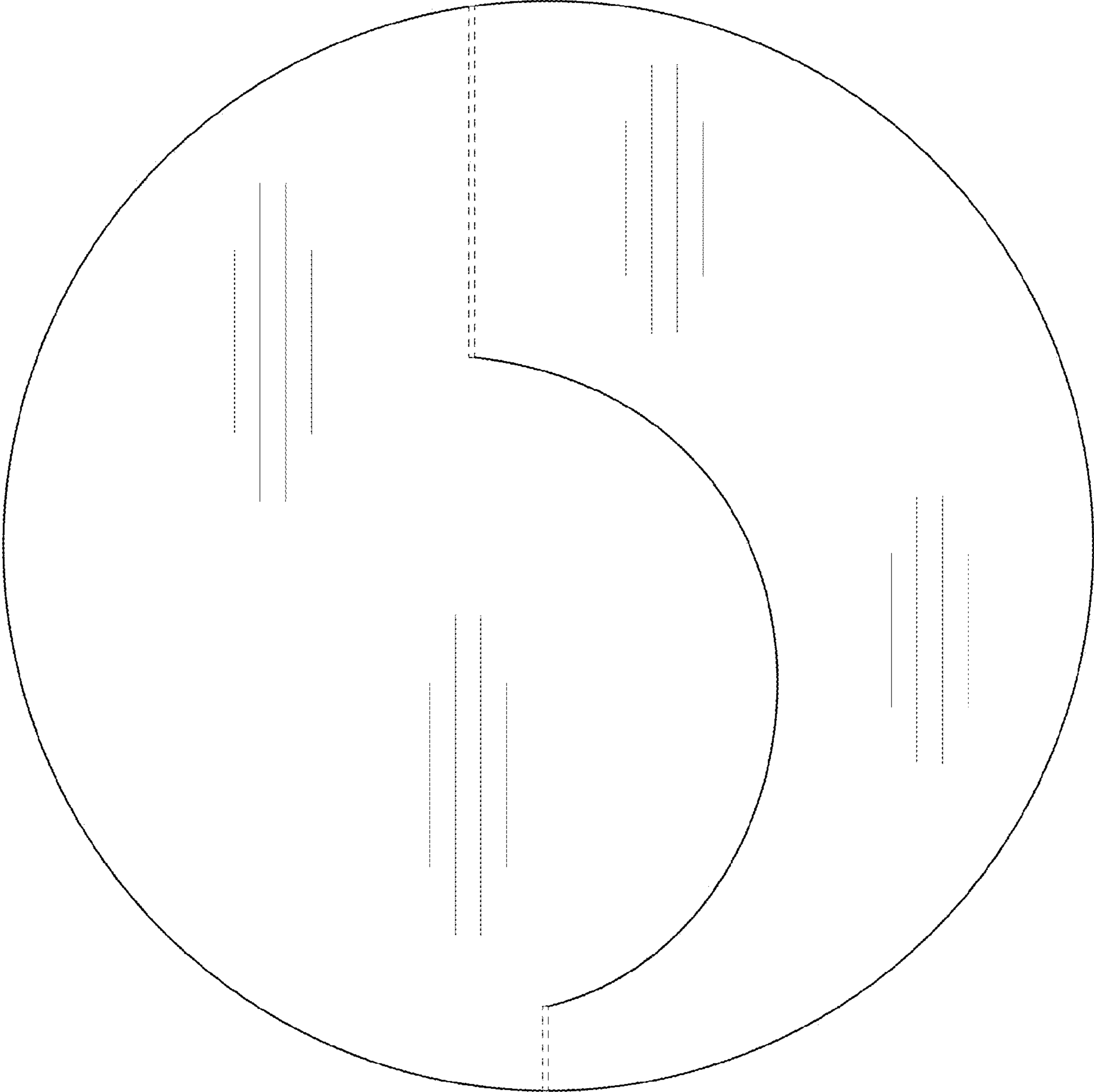

FIG. 7

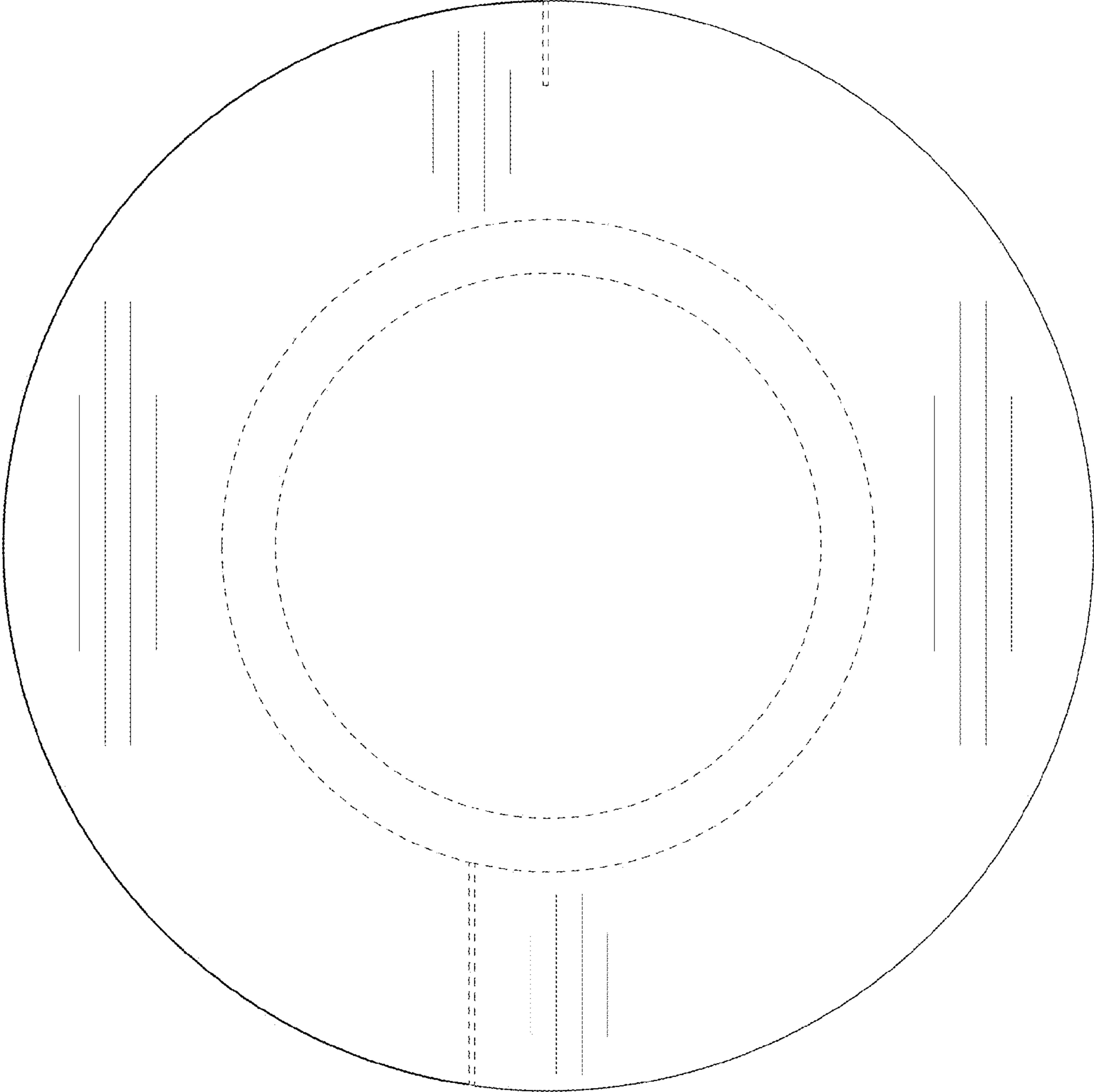

FIG. 8

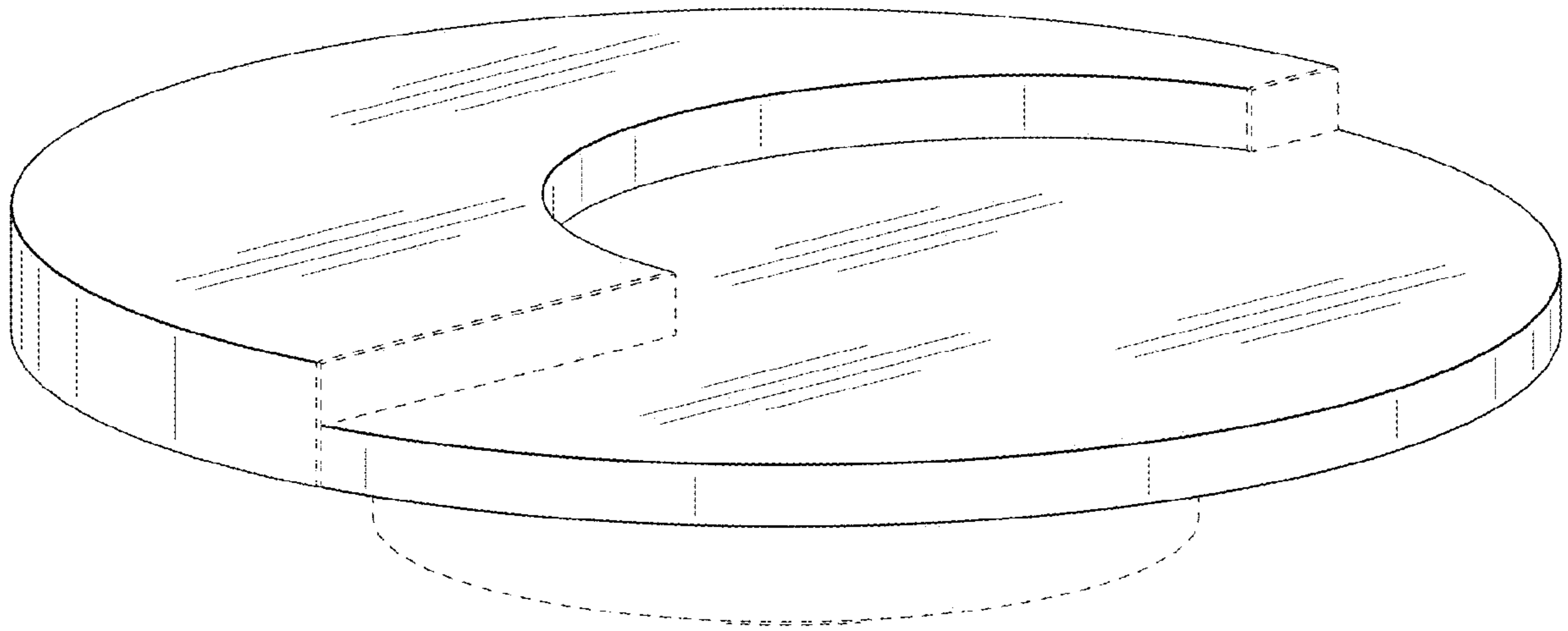

FIG. 9

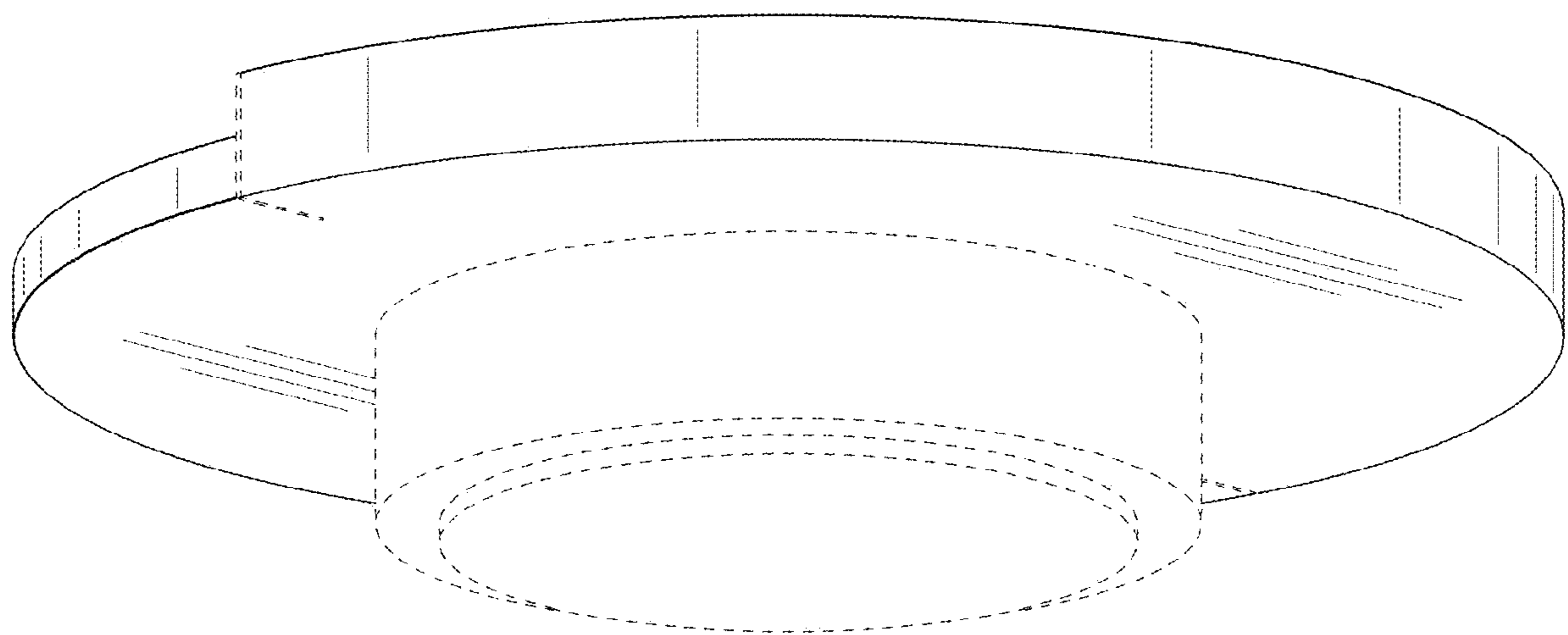

FIG. 10

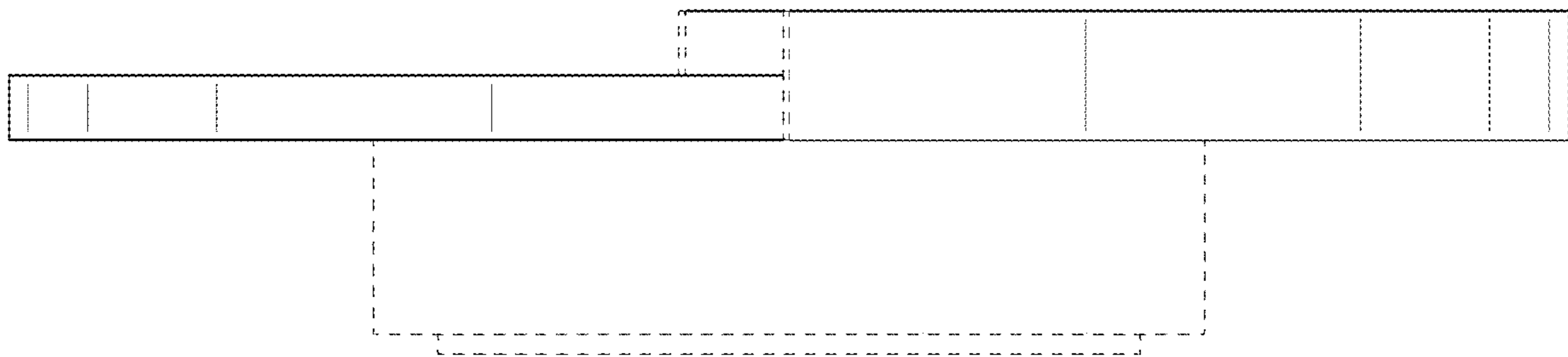

FIG. 11

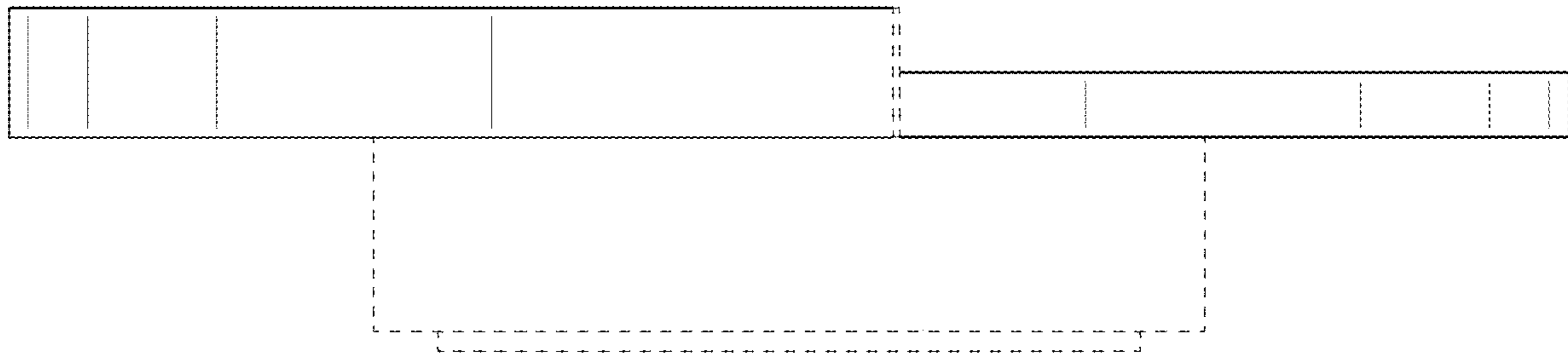

FIG. 12

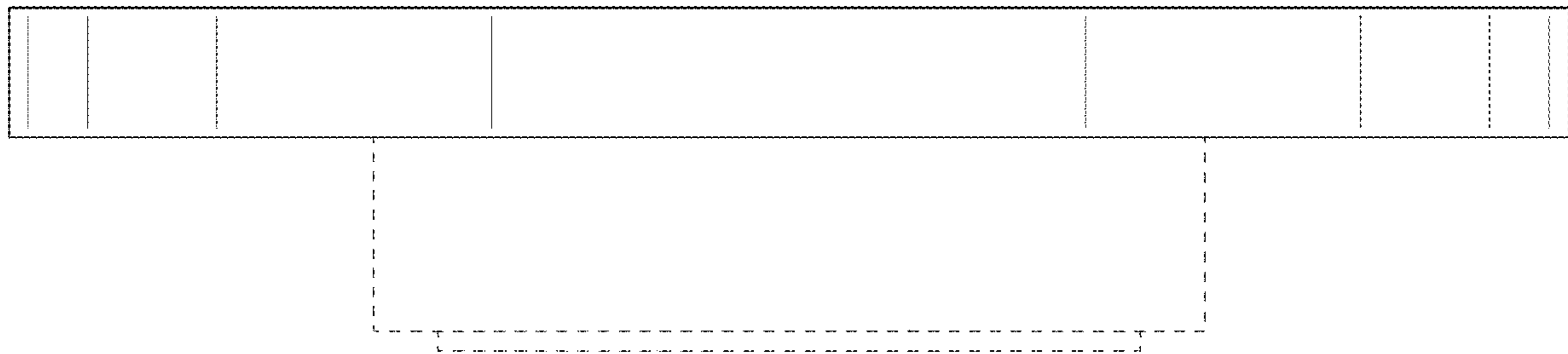

FIG. 13

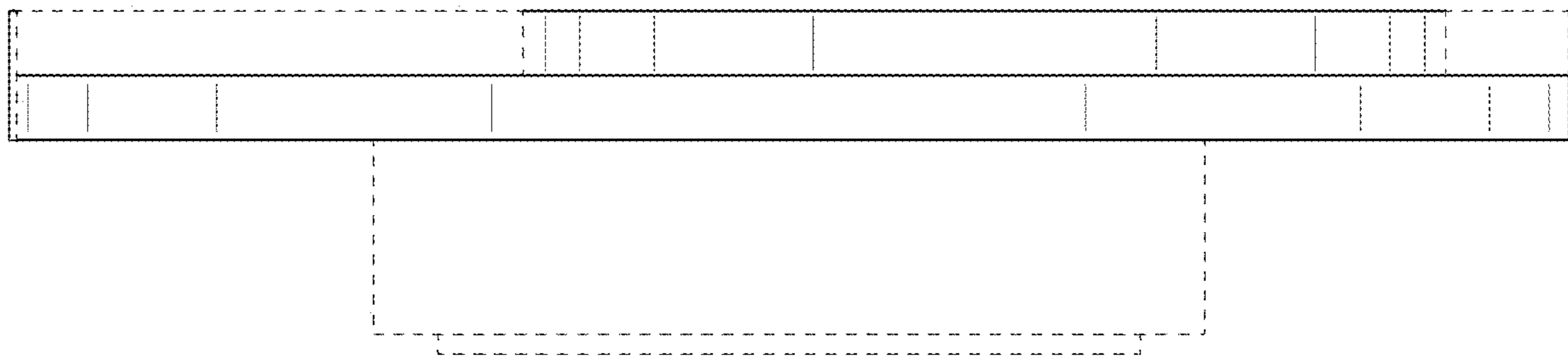

FIG. 14

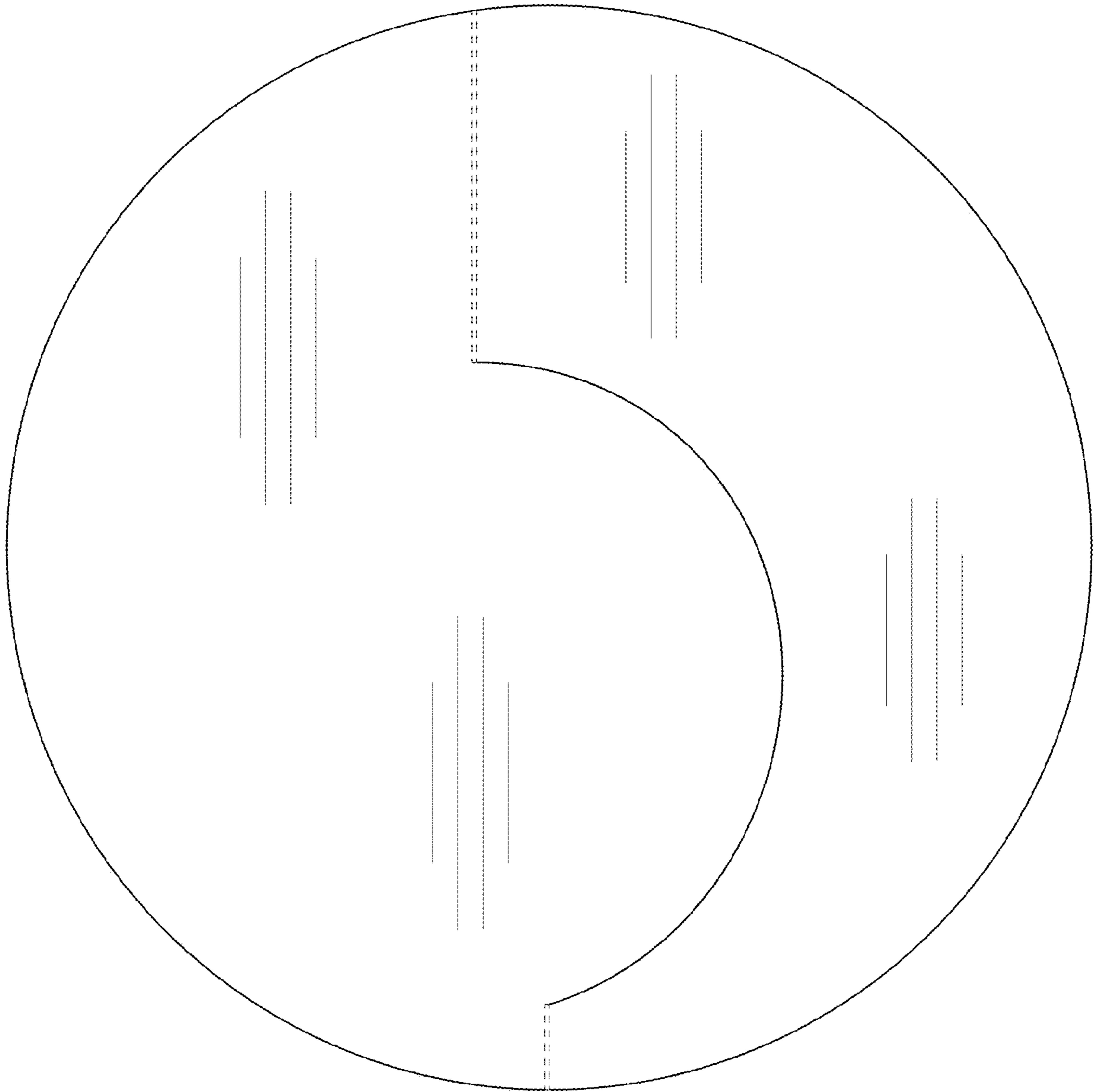

FIG. 15

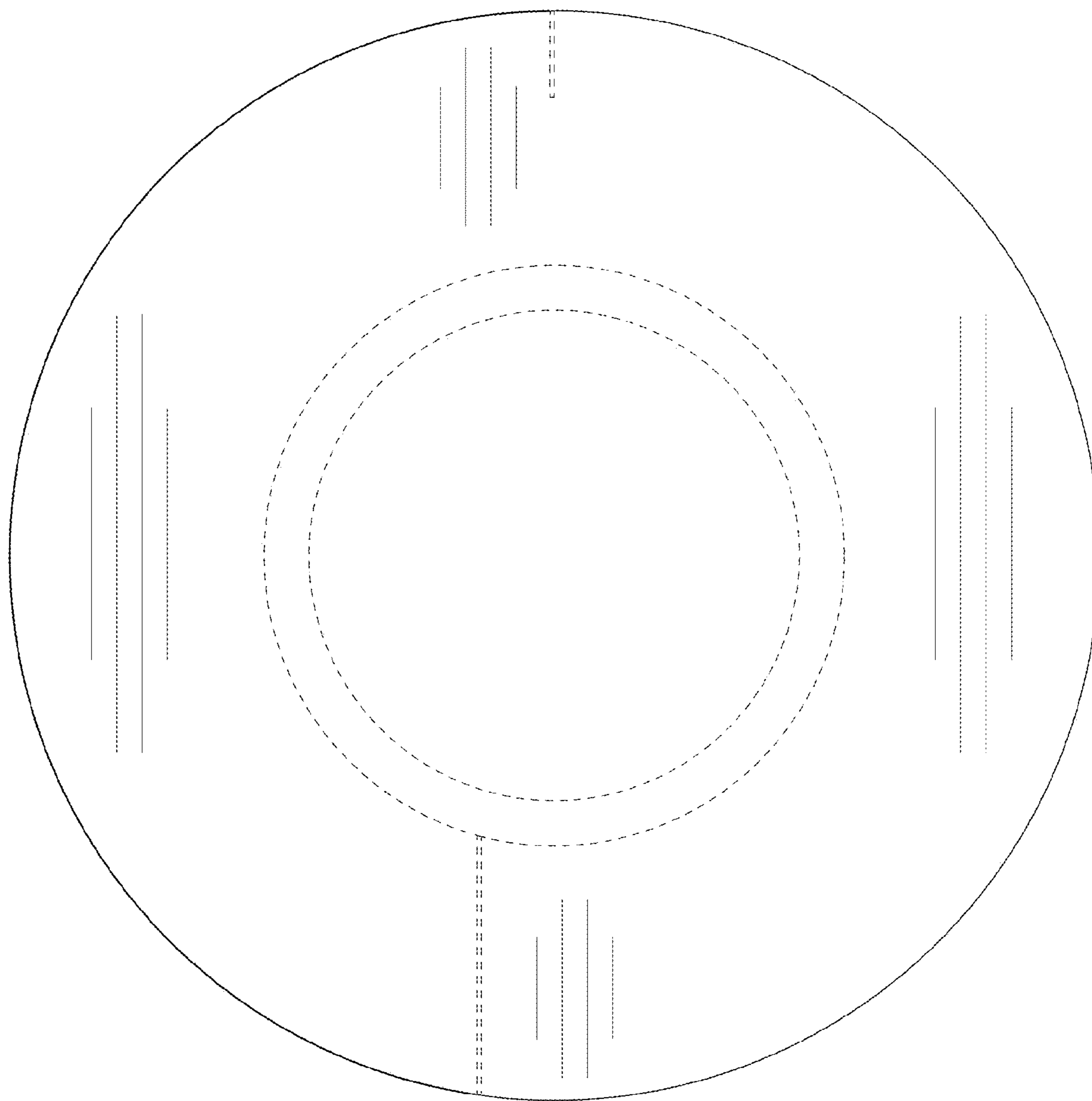

FIG. 16