



US00D941041S

(12) **United States Design Patent**
Fumiya et al.

(10) **Patent No.:** **US D941,041 S**
(45) **Date of Patent:** **** Jan. 18, 2022**

(54) **SMART MIRROR**

(71) Applicant: **SAMSUNG ELECTRONICS CO., LTD.**, Suwon-si (KR)

(72) Inventors: **Matsuoka Fumiya**, Suwon-si (KR);
Gi-Hoon Ko, Suwon-si (KR);
Yeon-Young Nam, Suwon-si (KR);
Seung-Wook Suh, Suwon-si (KR);
Sung-Jae Lee, Suwon-si (KR);
Young-Seok Lee, Suwon-si (KR);
Han-Min Lee, Suwon-si (KR); **Hae-Me Lee**, Suwon-si (KR)

(73) Assignee: **SAMSUNG ELECTRONICS CO., LTD.**, Gyeonggi-Do (KR)

(**) Term: **15 Years**

(21) Appl. No.: **29/733,903**

(22) Filed: **May 7, 2020**

(30) **Foreign Application Priority Data**

Nov. 8, 2019 (KR) 30-2019-0053354

(51) **LOC (13) Cl.** **06-07**

(52) **U.S. Cl.**
USPC **D6/310; D6/300**

(58) **Field of Classification Search**

USPC D6/300, 301, 302, 303, 304, 307, 308,
D6/309, 310, 311, 312, 313, 314;
D28/64.1-64.7; D14/336, 341, 371, 372,
D14/374, 381, 382, 448, 450; D19/113,
D19/114; D20/10, 27, 42
CPC A45D 42/00; A45D 42/10; A45D 42/16;
A45D 42/20; A45D 42/24; A47G 1/00;
A47G 1/02; A47G 1/04; A47G 1/0622;
B60J 3/0282

See application file for complete search history.

(56) **References Cited**

U.S. PATENT DOCUMENTS

D140,181 S * 1/1945 McGonigal D19/34.2
D271,832 S * 12/1983 Smith D19/91
(Continued)

FOREIGN PATENT DOCUMENTS

CN 303594535 S 2/2016
CN 303860059 * 3/2016
(Continued)

OTHER PUBLICATIONS

Mirror Display [online], [site visited Sep. 2021]. Available from internet, URL: <http://7kiosk.com/sub01_new.asp?idx=122&model_category=2> (Year: 2021).*
(Continued)

Primary Examiner — Cynthia Ramirez
Assistant Examiner — Xavier Marti-Santos
(74) *Attorney, Agent, or Firm* — Cantor Colburn LLP

(57) **CLAIM**

The ornamental design for a smart mirror, as shown and described.

DESCRIPTION

FIG. 1 is a front perspective view of a smart mirror, showing our new design;
FIG. 2 is a front view thereof;
FIG. 3 is a rear view thereof;
FIG. 4 is a left-side view thereof;
FIG. 5 is a right-side view thereof;
FIG. 6 is a top view thereof; and,
FIG. 7 is a bottom view thereof.
The broken lines illustrating portions of the smart mirror form no part of the claimed design.

1 Claim, 7 Drawing Sheets

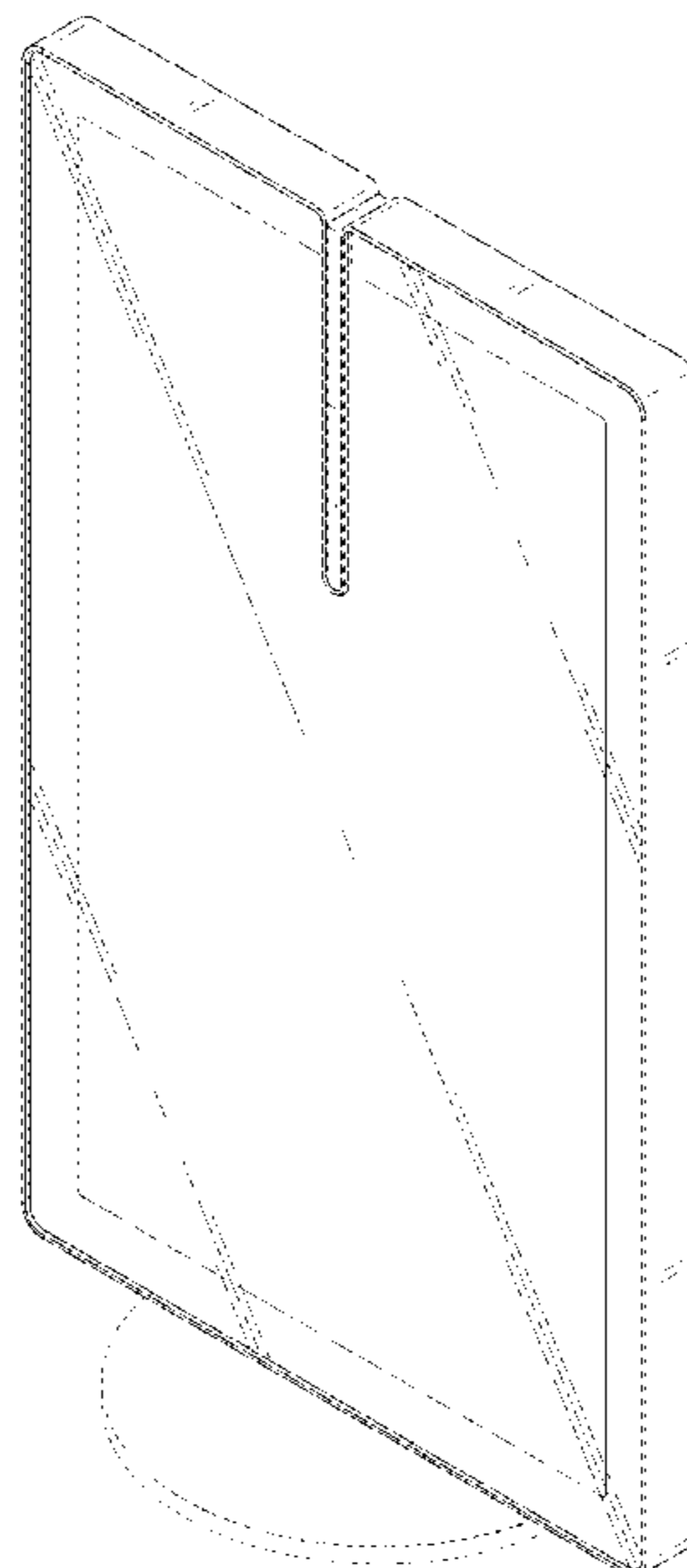

(56)

References Cited

U.S. PATENT DOCUMENTS

| | | | | | | |
|----------|---|---|---------|------------|-------|---------|
| D307,675 | S | * | 5/1990 | Jordan | | D6/300 |
| D375,980 | S | * | 11/1996 | Current | | D20/40 |
| D396,562 | S | * | 8/1998 | Kenney | | D6/300 |
| D423,796 | S | * | 5/2000 | Kwan | | D6/300 |
| D446,027 | S | * | 8/2001 | LeFevre | | D6/300 |
| D504,021 | S | * | 4/2005 | Stravitz | | D6/300 |
| D505,018 | S | * | 5/2005 | Stravitz | | D6/300 |
| D787,840 | S | * | 5/2017 | Spigler | | D6/310 |
| D811,395 | S | * | 2/2018 | Bae | | D14/374 |
| D882,281 | S | * | 4/2020 | Park | | D6/310 |
| D895,984 | S | * | 9/2020 | Matthewman | | D6/310 |

FOREIGN PATENT DOCUMENTS

| | | | |
|----|----------------|------|---------|
| CN | 306691710 | * | 4/2021 |
| EM | 002087460-0001 | | 8/2012 |
| EM | 002519256-0003 | | 8/2014 |
| EM | 003059419-0001 | | 4/2016 |
| KR | 1736395 | B1 * | 11/2014 |
| KR | 2019117099 | * | 4/2018 |
| KR | 300978194 | S | 4/2019 |

OTHER PUBLICATIONS

Fancii 10X Magnifying Lighted Makeup Mirror [online], [site visited Sep. 2021]. Available from internet, URL: <<https://www.amazon.com/Fancii-Magnifying-Lighted-Makeup-Mirror/dp/B01GH5VMBM/>> (Year: 2016).*

LED Makeup Mirror [online], [site visited Sep. 2021]. Available from internet, URL: <<https://www.amazon.com/Mirror%EF%BC%8CSquare-Lights%EF%BC%8C-Convenient-Hand%EF%BC%8CTouch-Lighting/dp/B096ZXVGD2/>> (Year: 2021).*

* cited by examiner

FIG. 1

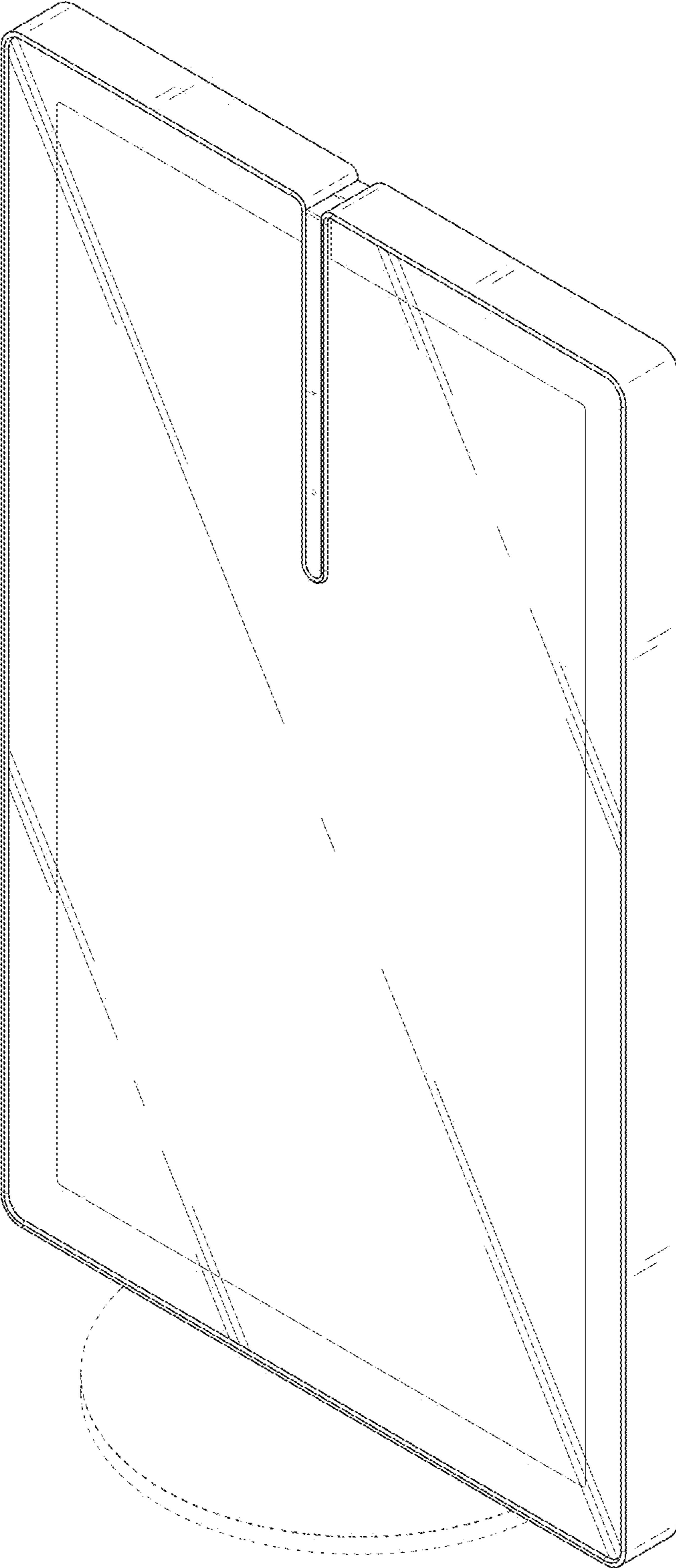

FIG. 2

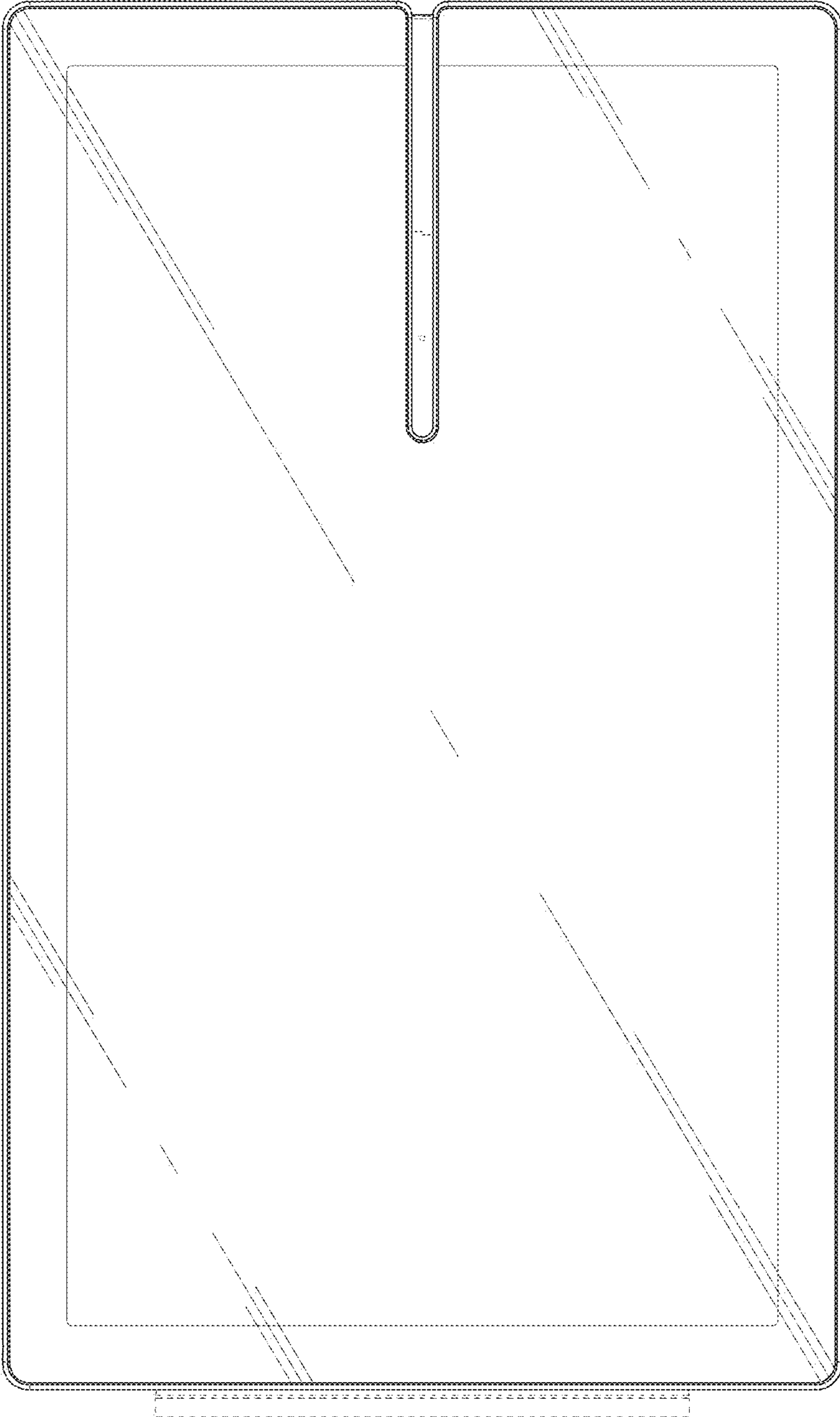

FIG. 3

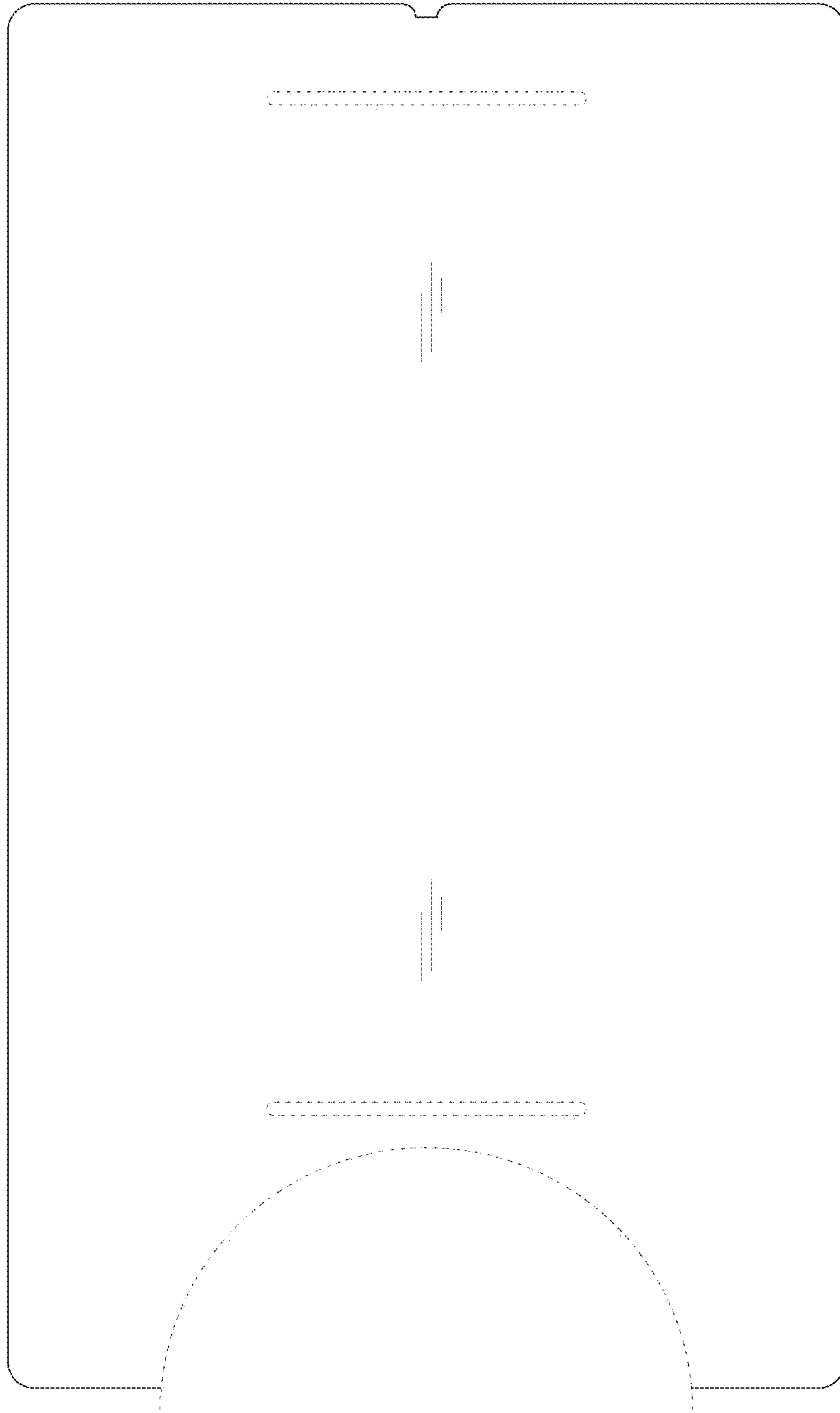

FIG. 4

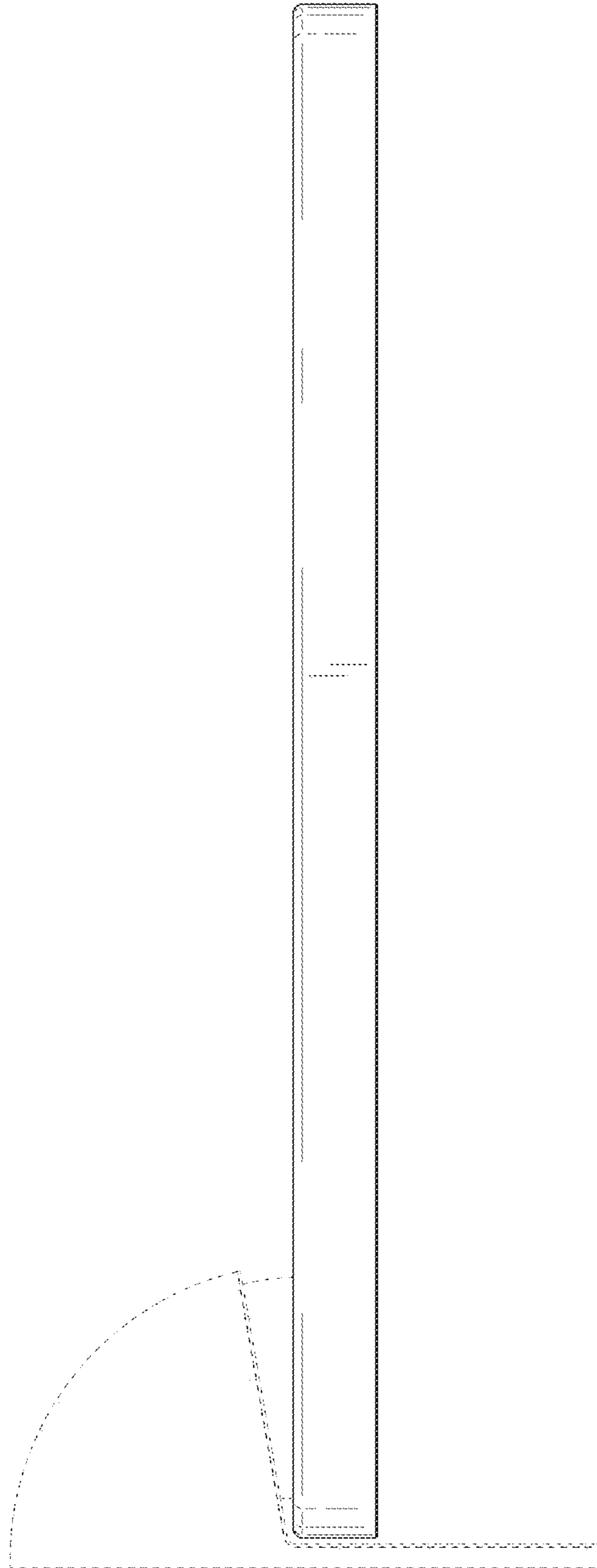

FIG. 5

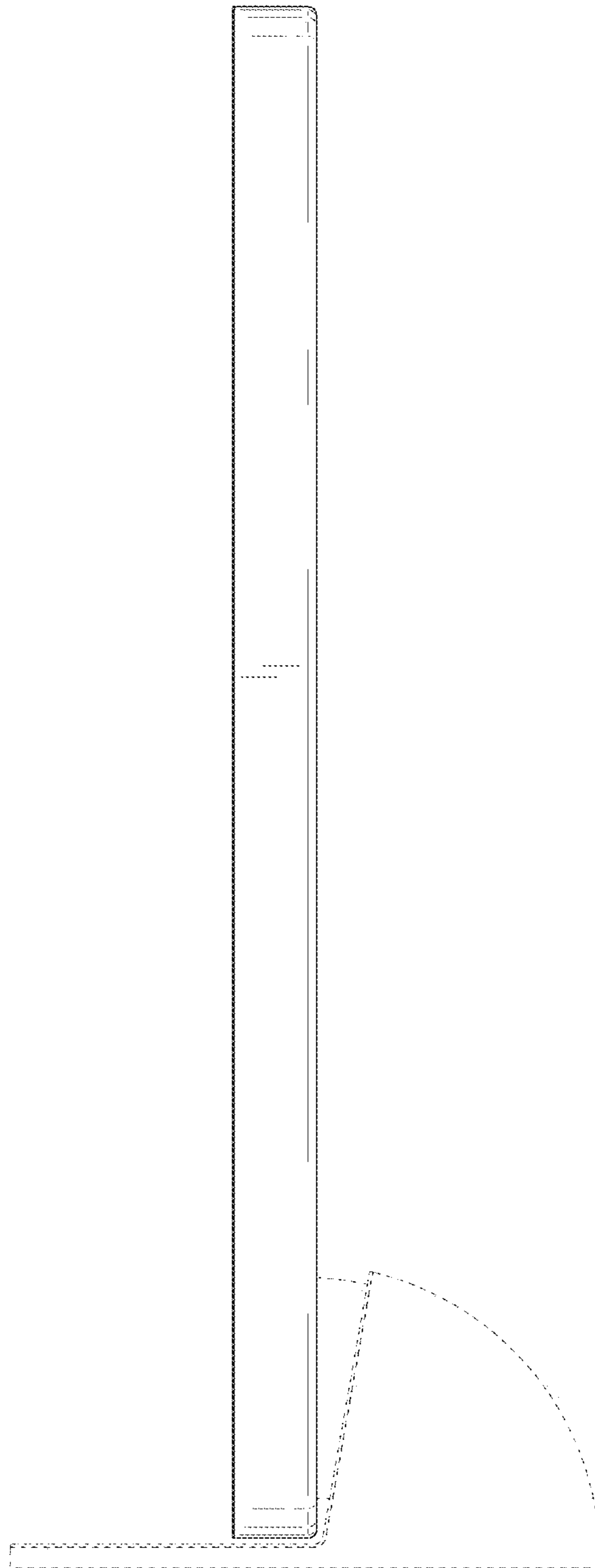

FIG. 6

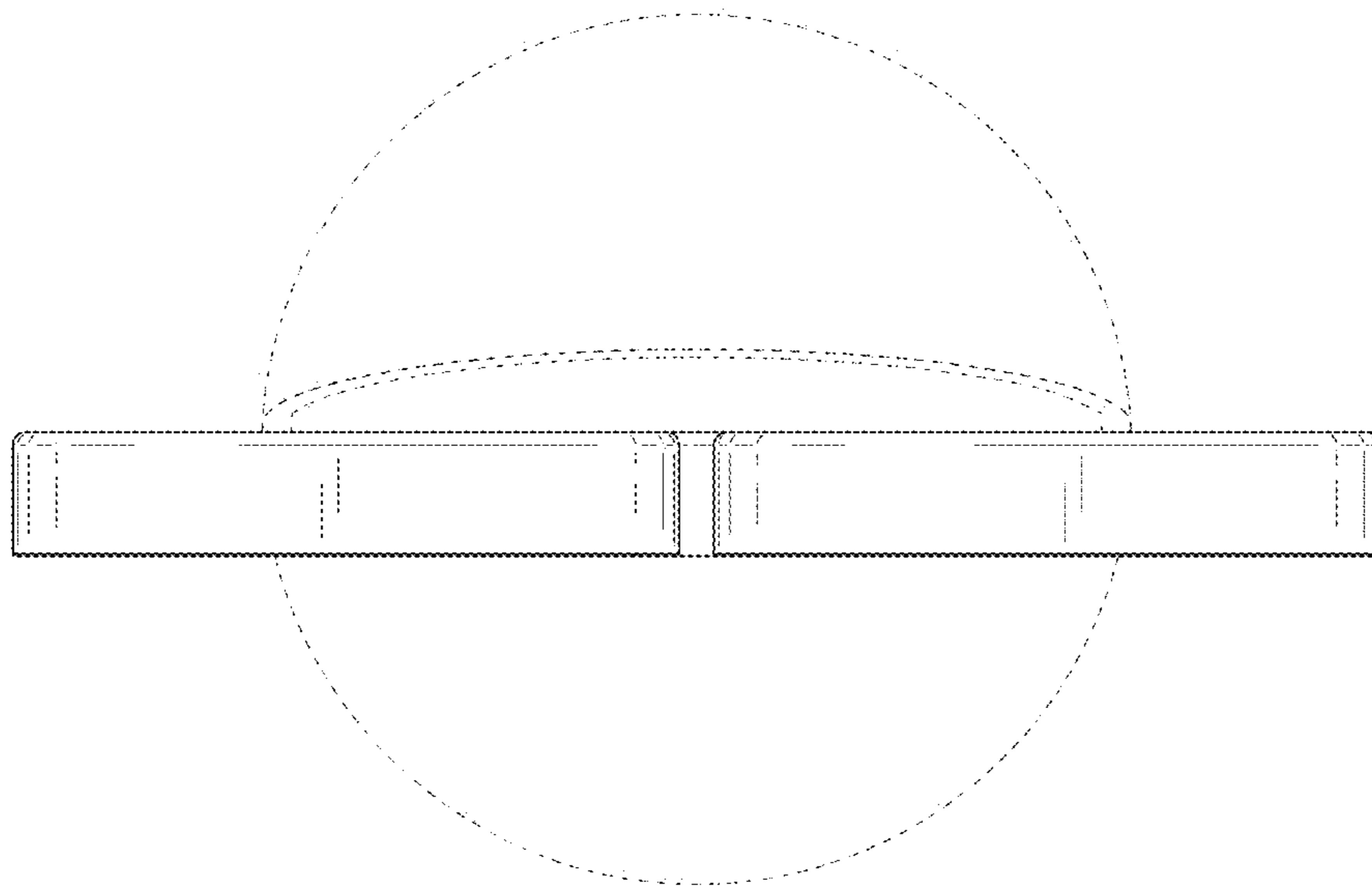

FIG. 7

