



US00D941013S

(12) **United States Design Patent**  
**Qiu**

(10) **Patent No.:** **US D941,013 S**  
(45) **Date of Patent:** **\*\* Jan. 18, 2022**

- (54) **BACKPACK**
- (71) Applicant: **Caiming Qiu**, Shangrao (CN)
- (72) Inventor: **Caiming Qiu**, Shangrao (CN)
- (\*\*) Term: **15 Years**
- (21) Appl. No.: **29/778,812**
- (22) Filed: **Apr. 15, 2021**
- (51) **LOC (13) Cl.** ..... **03-01**
- (52) **U.S. Cl.**  
USPC ..... **D3/217**
- (58) **Field of Classification Search**  
USPC ..... D3/216, 217, 243; D6/391  
CPC ..... A45F 3/04; A45F 2003/003; A45F 4/02;  
A45F 5/021; Y10S 224/92; Y10S 16/40;  
Y10S 224/922; Y10S 383/907; A01K  
97/06; A45C 11/20; A45C 5/06; A45C  
11/02; A45C 13/02; A45C 13/08; A45C  
3/00; A45C 7/0063  
See application file for complete search history.

(56) **References Cited**  
U.S. PATENT DOCUMENTS

D829,435 S	10/2018	Viger et al.	
D854,817 S	7/2019	Rabe et al.	
D879,464 S *	3/2020	Vario, Jr.	D3/217
D885,042 S *	5/2020	Li	D3/217
D891,143 S *	7/2020	Ren	D6/391
D895,272 S *	9/2020	Zhitian	D3/217

- 2003/0024960 A1\* 2/2003 Greenstein ..... A45F 3/047  
224/153
  - 2011/0314608 A1\* 12/2011 Rovin ..... A47D 5/006  
5/655
  - 2019/0082817 A1\* 3/2019 Ji ..... A47D 5/006
- \* cited by examiner

*Primary Examiner* — Jennifer L Watkins

(57) **CLAIM**

The ornamental design for a backpack, as shown and described.

**DESCRIPTION**

FIG. 1 is a perspective view of a backpack showing my new design;  
 FIG. 2 is another perspective view thereof;  
 FIG. 3 is a front elevational view thereof;  
 FIG. 4 is a rear elevational view thereof;  
 FIG. 5 is a left side elevational view thereof;  
 FIG. 6 is a right side elevational view thereof;  
 FIG. 7 is a top plan view thereof;  
 FIG. 8 is a bottom plan view thereof;  
 FIG. 9 is a perspective view of the backpack where the backpack is in a closed state; and,  
 FIG. 10 is an enlarged view of portion 10 shown in FIG. 1. The broken lines in the drawings depict portions of the backpack that form no part of the claimed design. The unevenly dashed lines in FIG. 1 and FIG. 10 depict the outline of the sectional view and form no part of the claim.

**1 Claim, 10 Drawing Sheets**

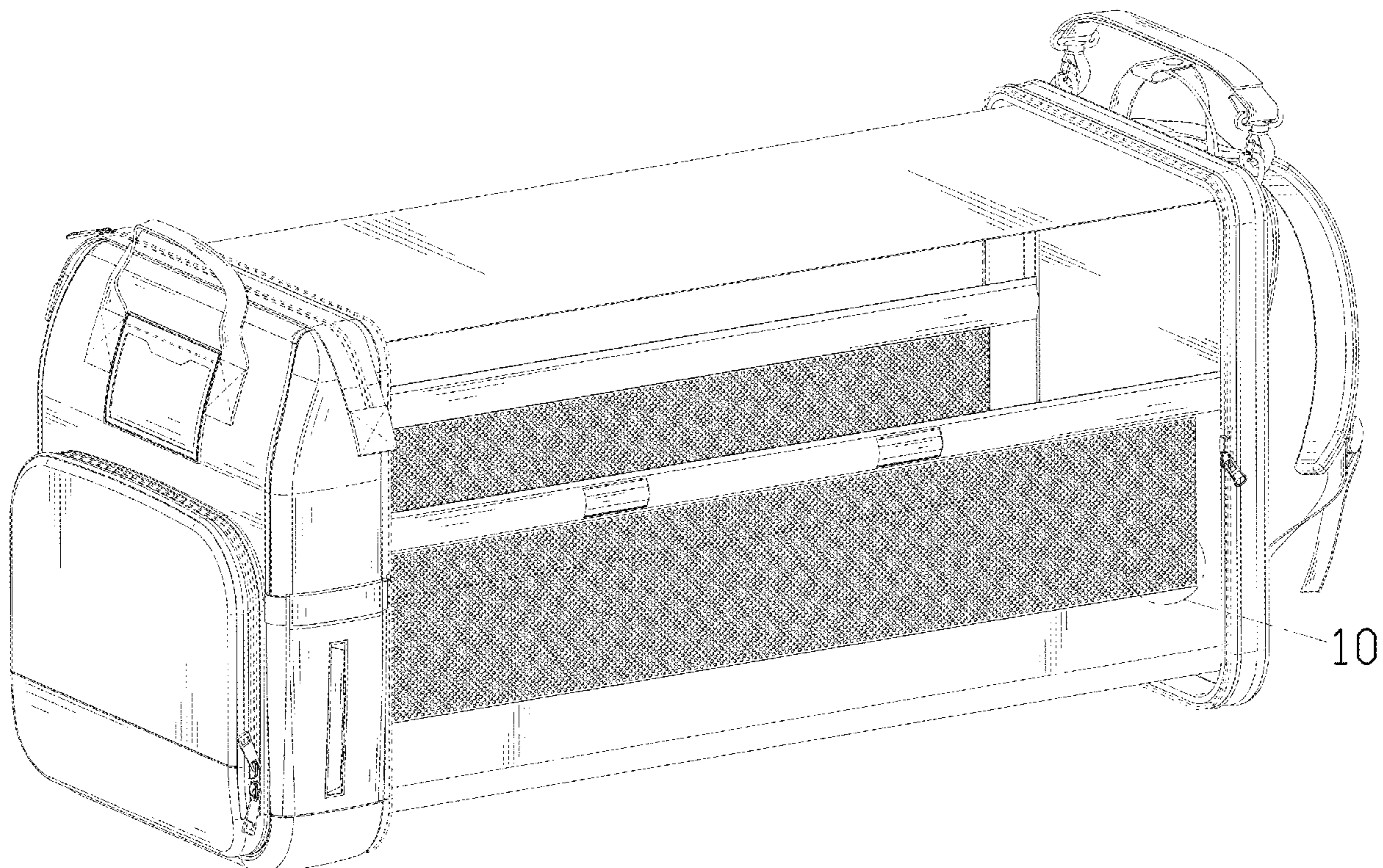

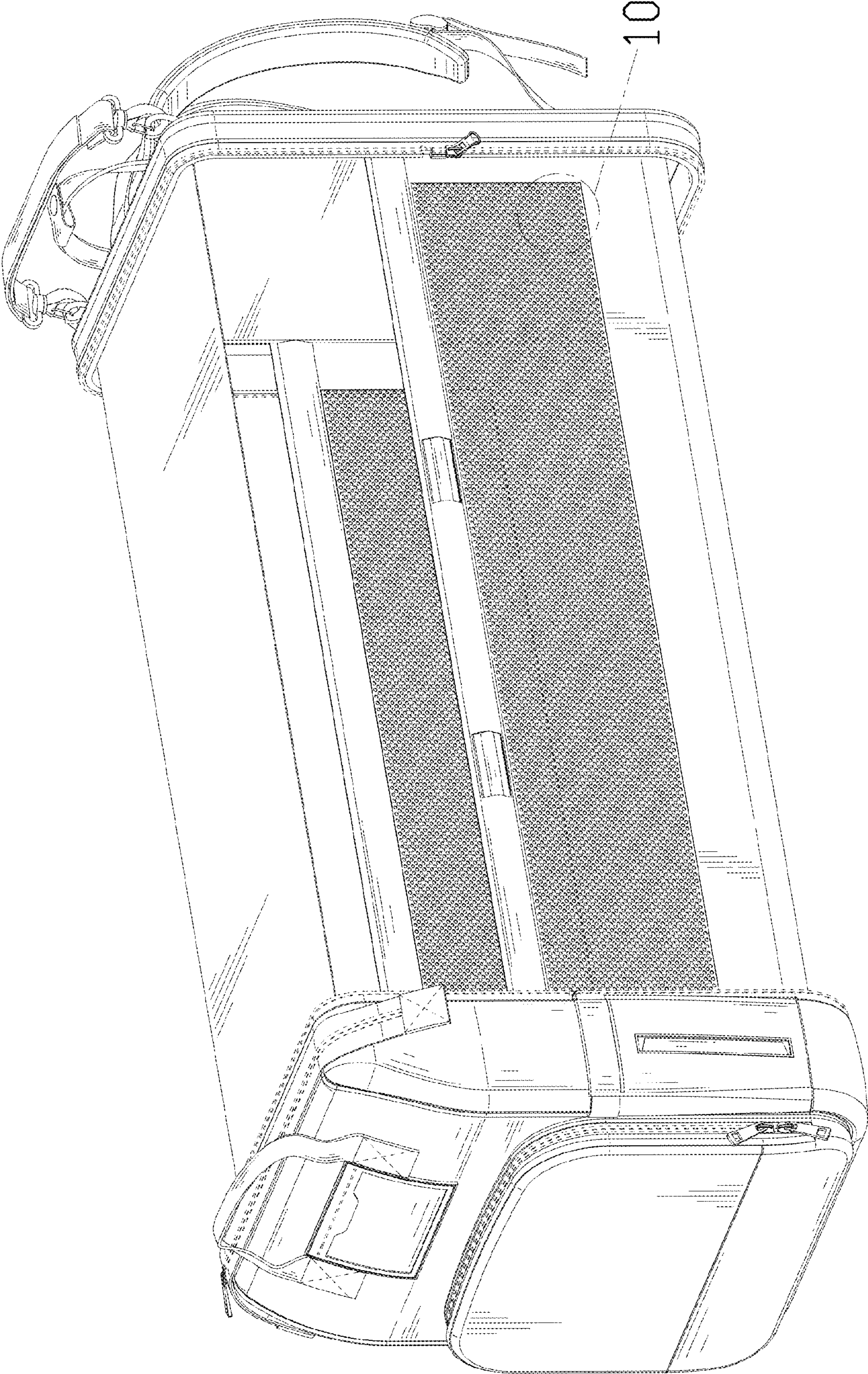

FIG. 1

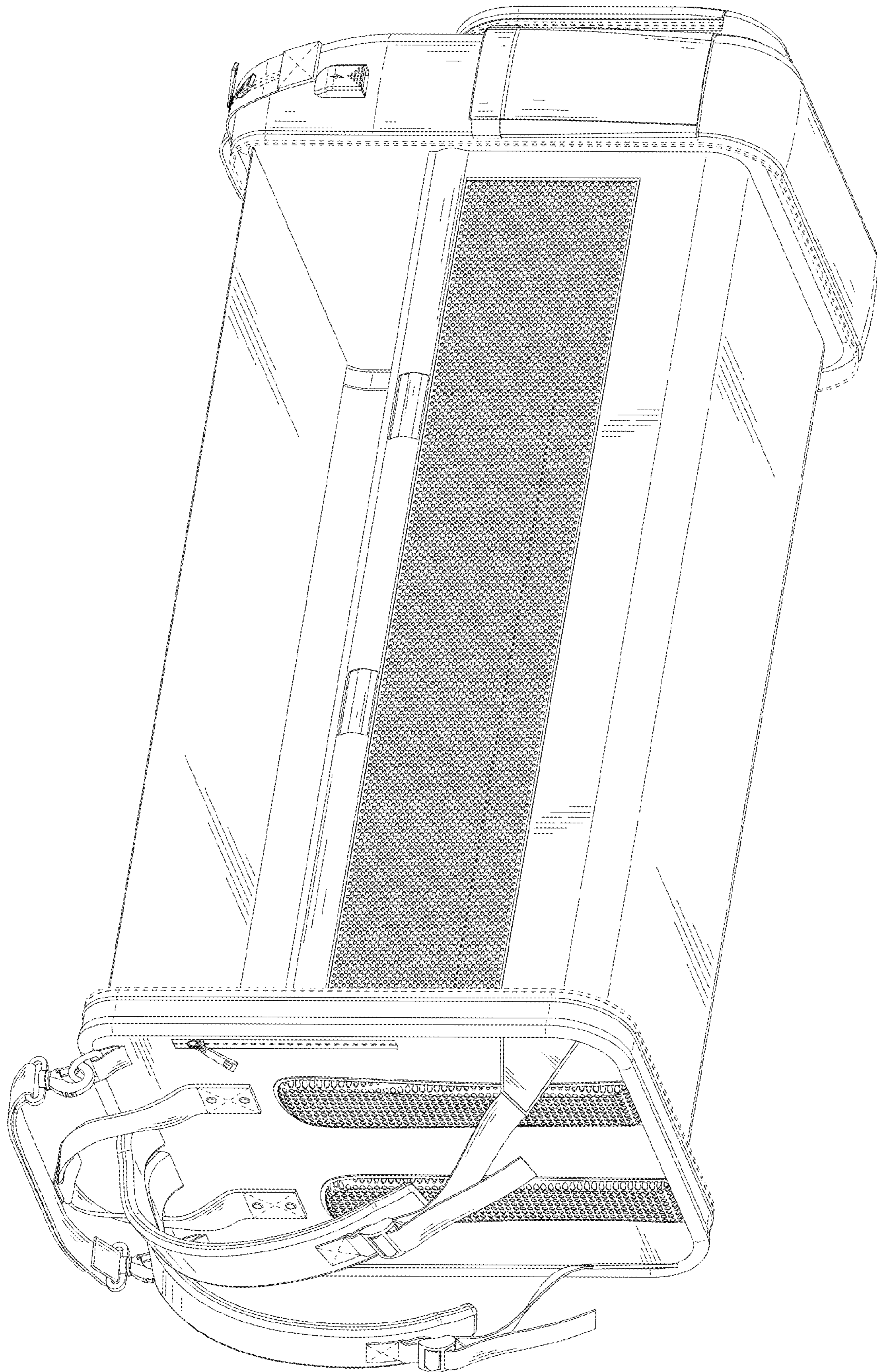

FIG. 2

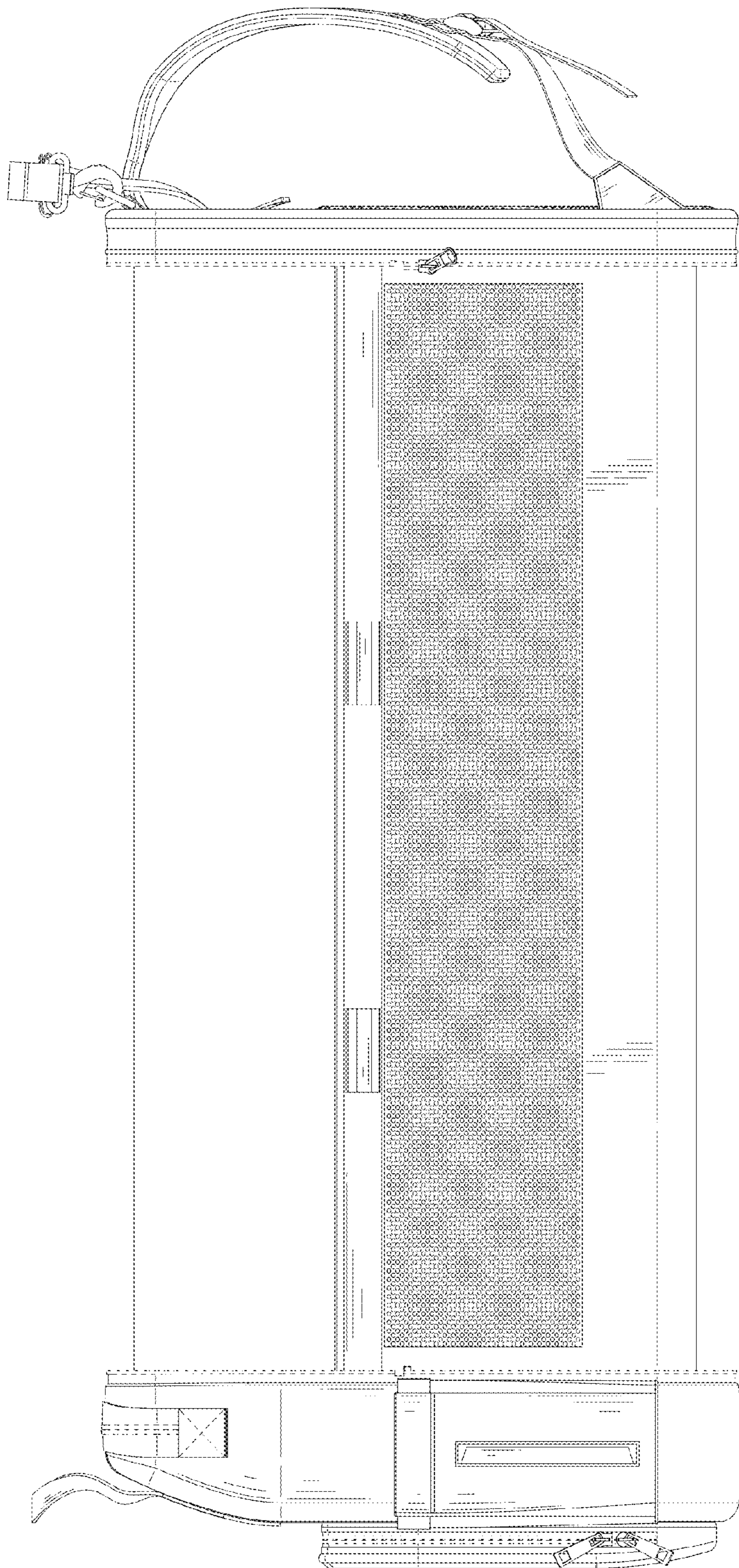

FIG. 3

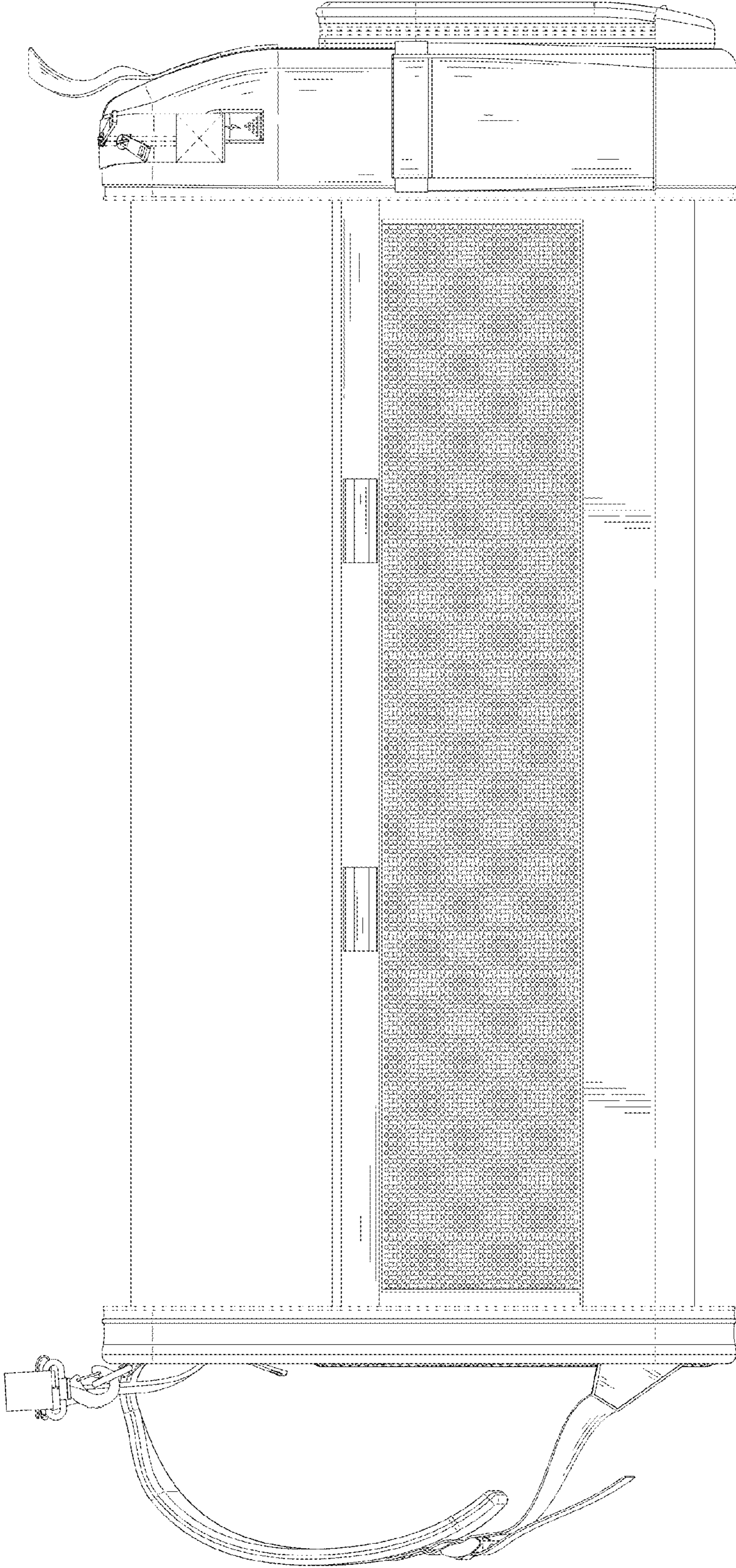

FIG. 4

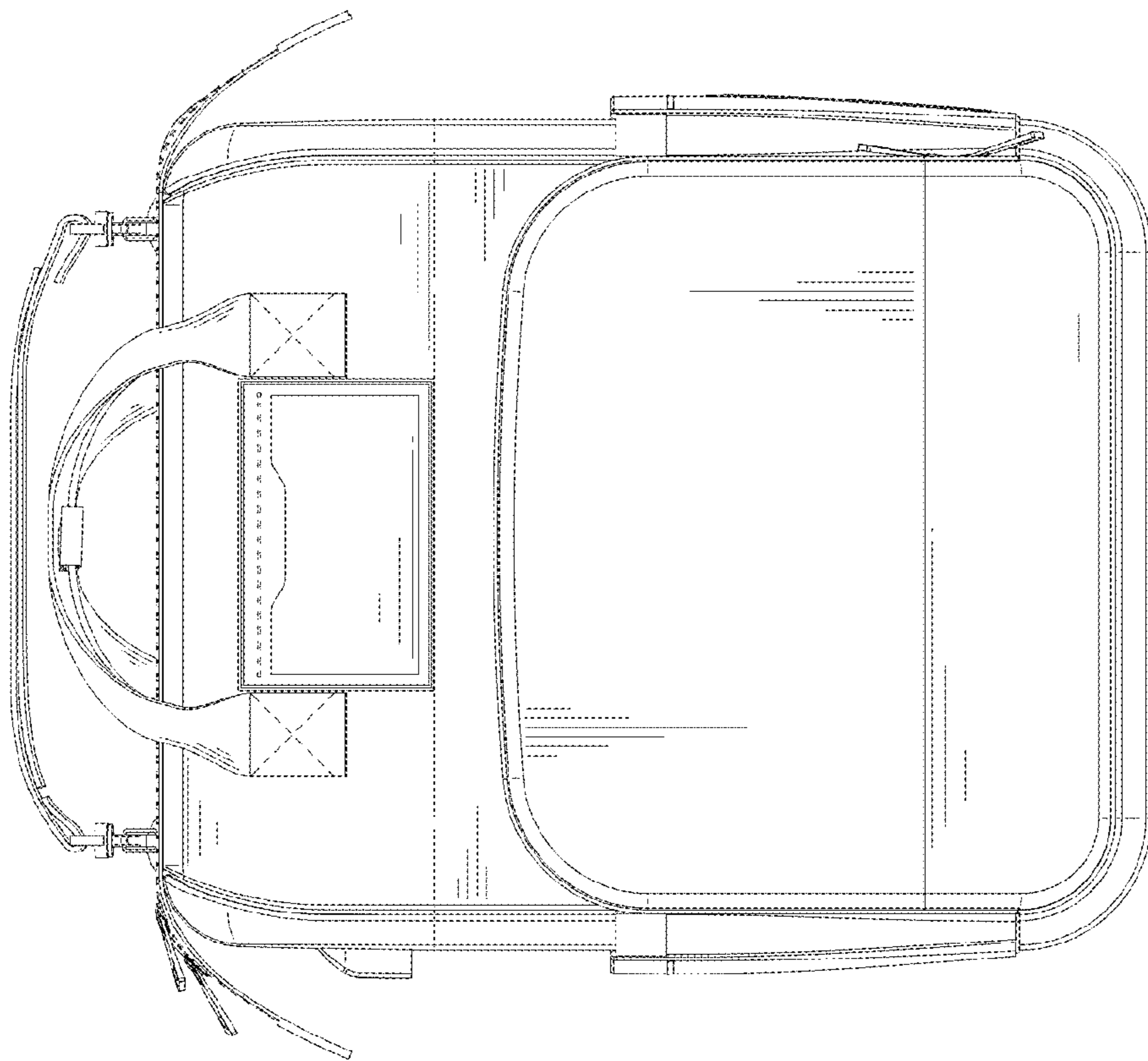

FIG. 5

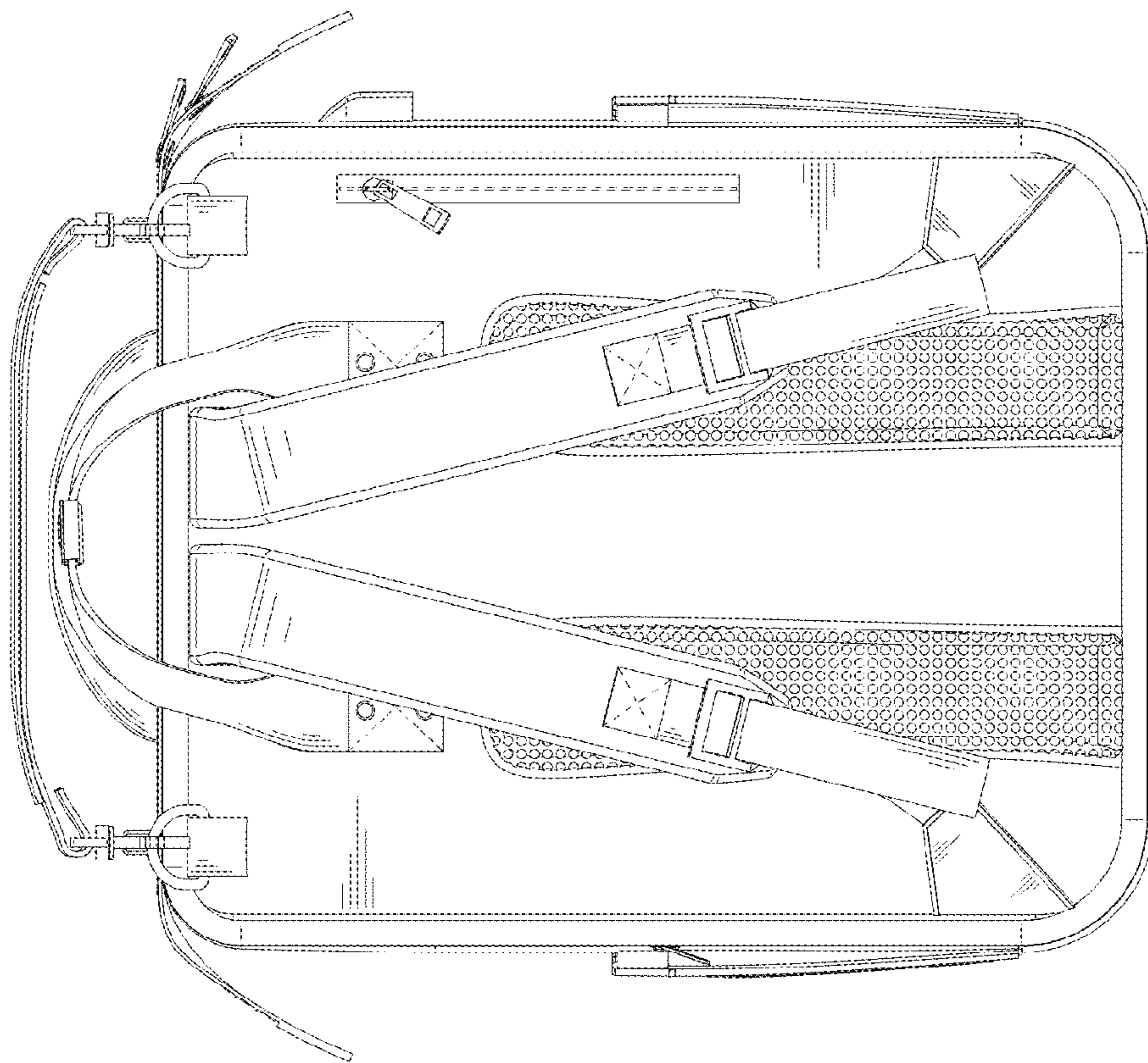

FIG. 6

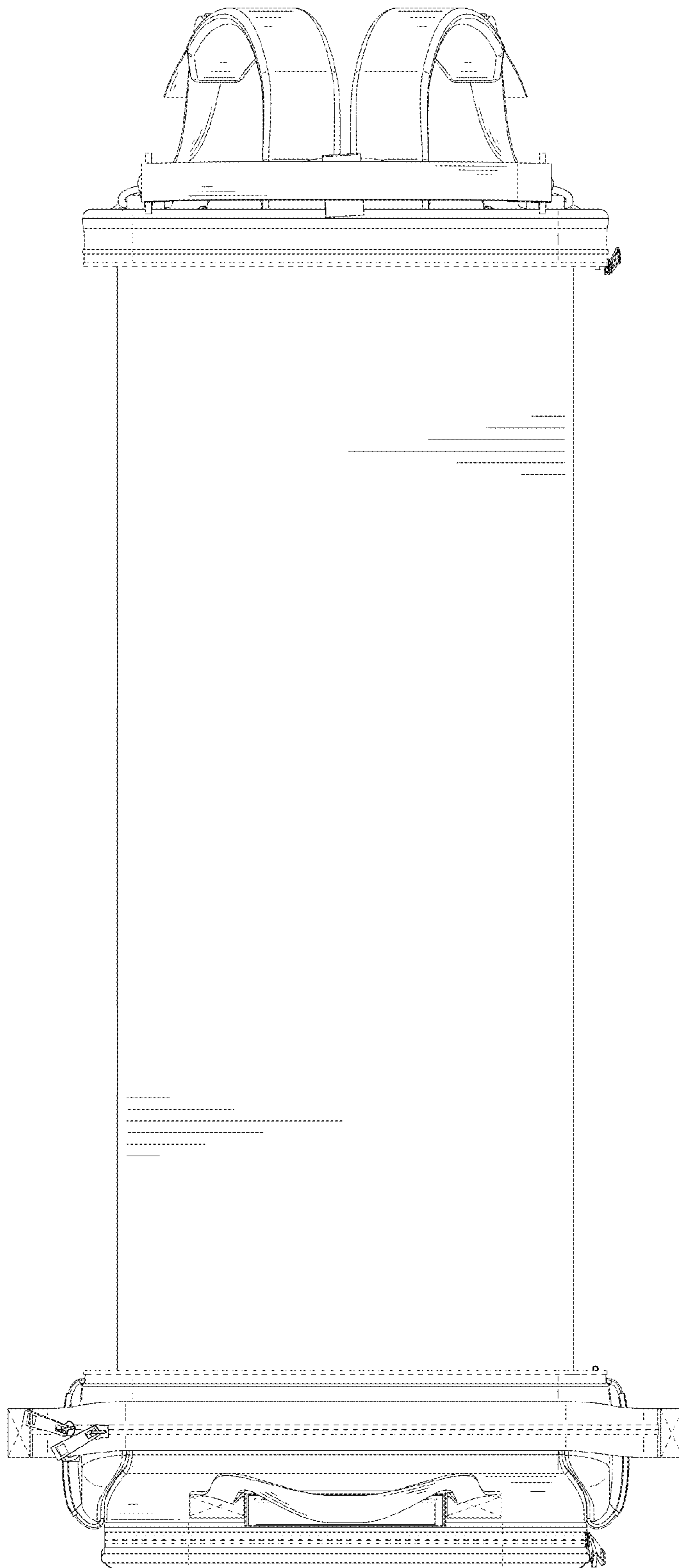

FIG. 7



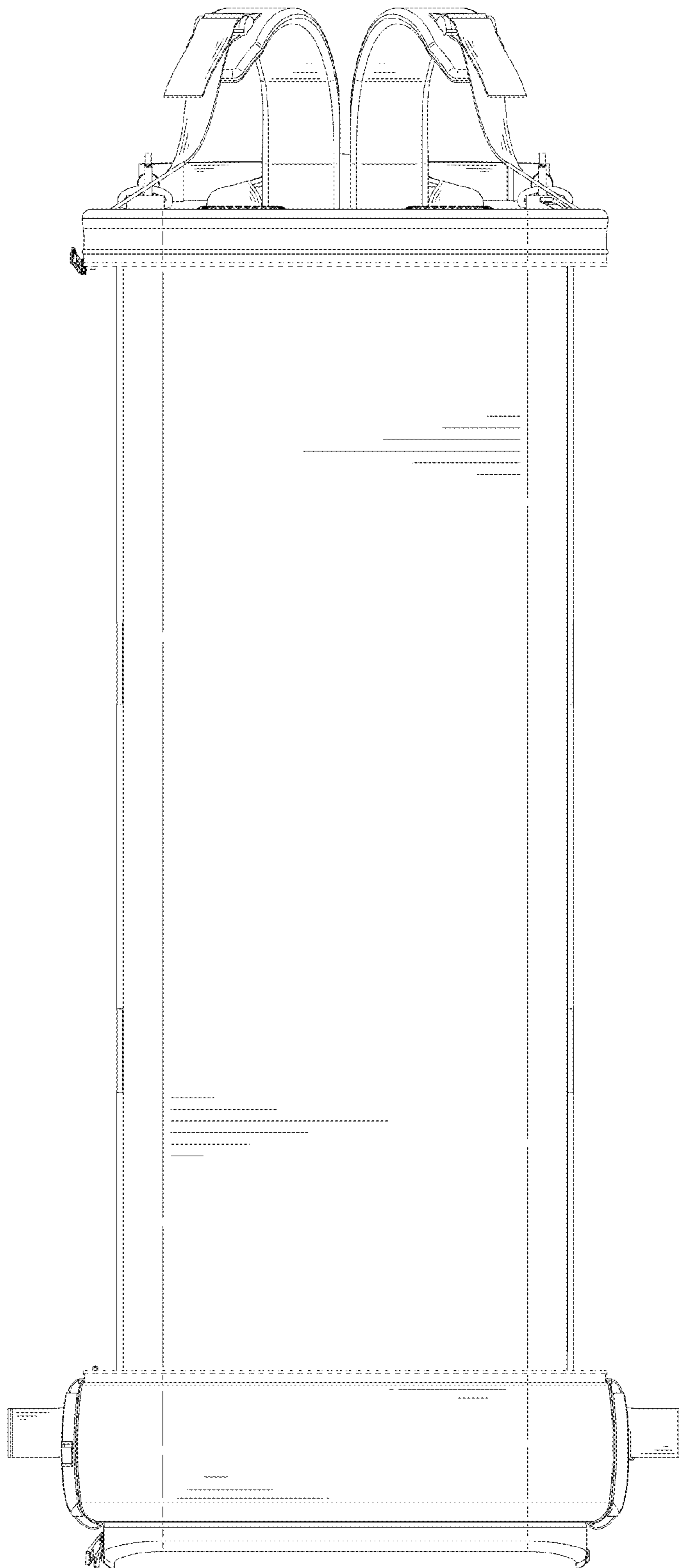

FIG. 8



FIG. 9

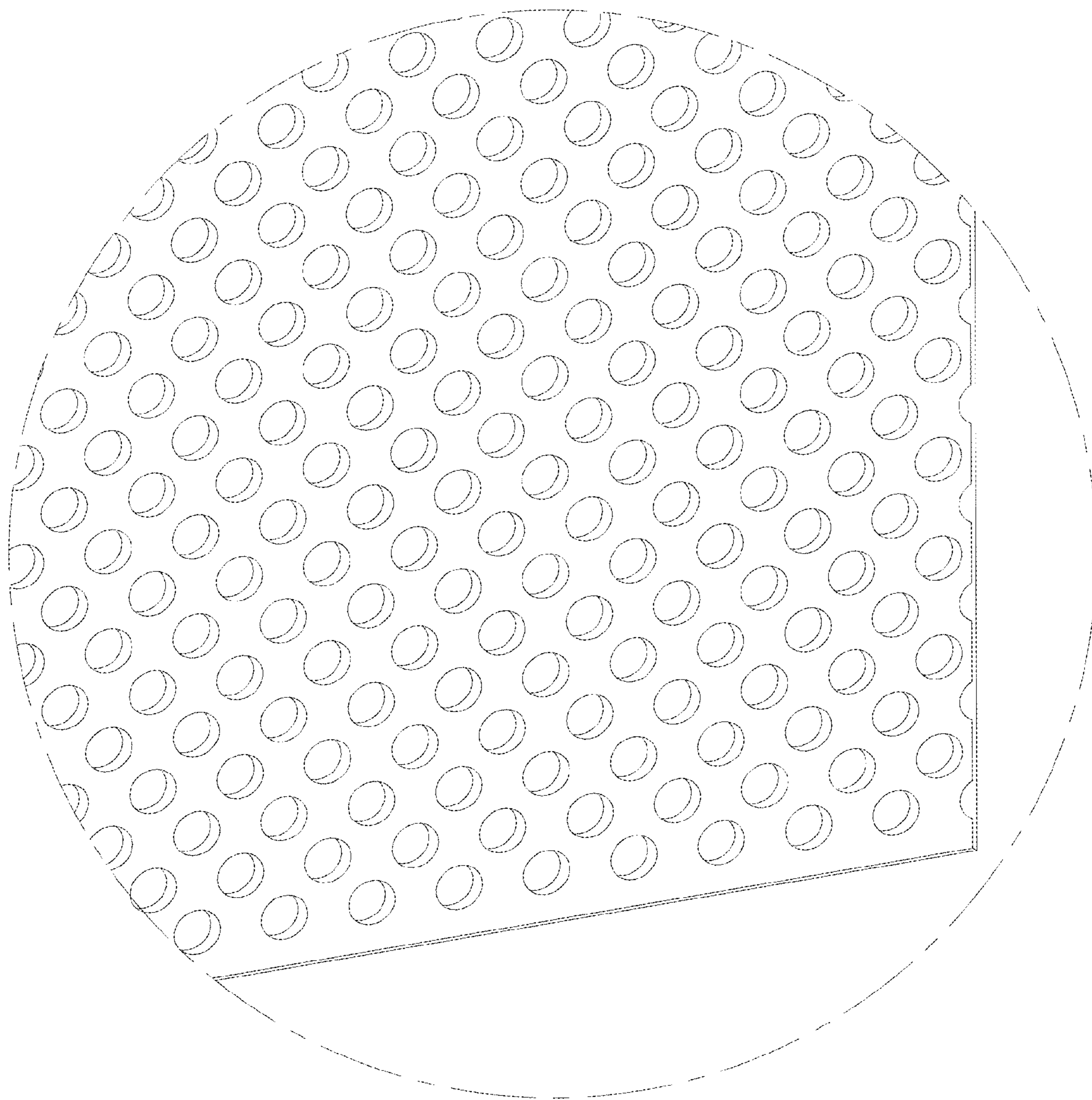

FIG. 10