

US00D940995S

(12) **United States Design Patent**
Pan

(10) **Patent No.:** **US D940,995 S**
(45) **Date of Patent:** **** Jan. 18, 2022**

(54) **LINGERIE**

(71) Applicant: **Silin Pan**, Shenzhen (CN)

(72) Inventor: **Silin Pan**, Shenzhen (CN)

(**) Term: **15 Years**

(21) Appl. No.: **29/706,017**

(22) Filed: **Sep. 17, 2019**

(51) **LOC (13) Cl.** **02-01**

(52) **U.S. Cl.**
USPC **D2/706**

(58) **Field of Classification Search**
USPC D2/705-709, 736-737, 731
CPC A41C 3/00; A41C 3/02; A41C 3/12; A41C
3/0057

See application file for complete search history.

(56) **References Cited**

U.S. PATENT DOCUMENTS

2,488,583	A *	11/1949	Coffinan	A41C 3/00 450/93
3,746,008	A *	7/1973	LoCascio	A41C 3/00 450/74
D452,601	S *	1/2002	Allen	D2/706
D523,212	S *	6/2006	Iourina	D2/706
D597,279	S *	8/2009	Spillman	D2/706
D625,487	S *	10/2010	Hendrickson	D2/706
D641,133	S *	7/2011	Zarabi	D2/708
D806,357	S *	1/2018	Waldman	D2/731
D860,582	S *	9/2019	Jameson	D2/706

D871,718	S *	1/2020	Pan	D2/706
D889,071	S *	7/2020	Liu	D2/706
2005/0098258	A1 *	5/2005	Batcha	A41F 15/00 156/250

* cited by examiner

Primary Examiner — Kevin K Rudzinski

Assistant Examiner — J. Thorn, Sr.

(74) *Attorney, Agent, or Firm* — Law Offices of Steven W. Weinrieb

(57) **CLAIM**

The ornamental design for a lingerie, as shown and described.

DESCRIPTION

FIG. 1 is a front, left side, top perspective view of a lingerie showing my new design;
 FIG. 2 is a front elevational view thereof;
 FIG. 3 is a rear elevational view thereof;
 FIG. 4 is a right side elevational view thereof;
 FIG. 5 is a left side elevational view thereof;
 FIG. 6 is a top plan view thereof;
 FIG. 7 is a bottom plan view thereof;
 FIG. 8 is a front elevational view thereof when the lingerie is opened; and,
 FIG. 9 is a rear elevational view thereof when the lingerie is opened.

The broken lines immediately adjacent to the claimed portions are boundaries, all other broken lines are environmental structures; all the broken lines form no part of the claimed design.

1 Claim, 9 Drawing Sheets



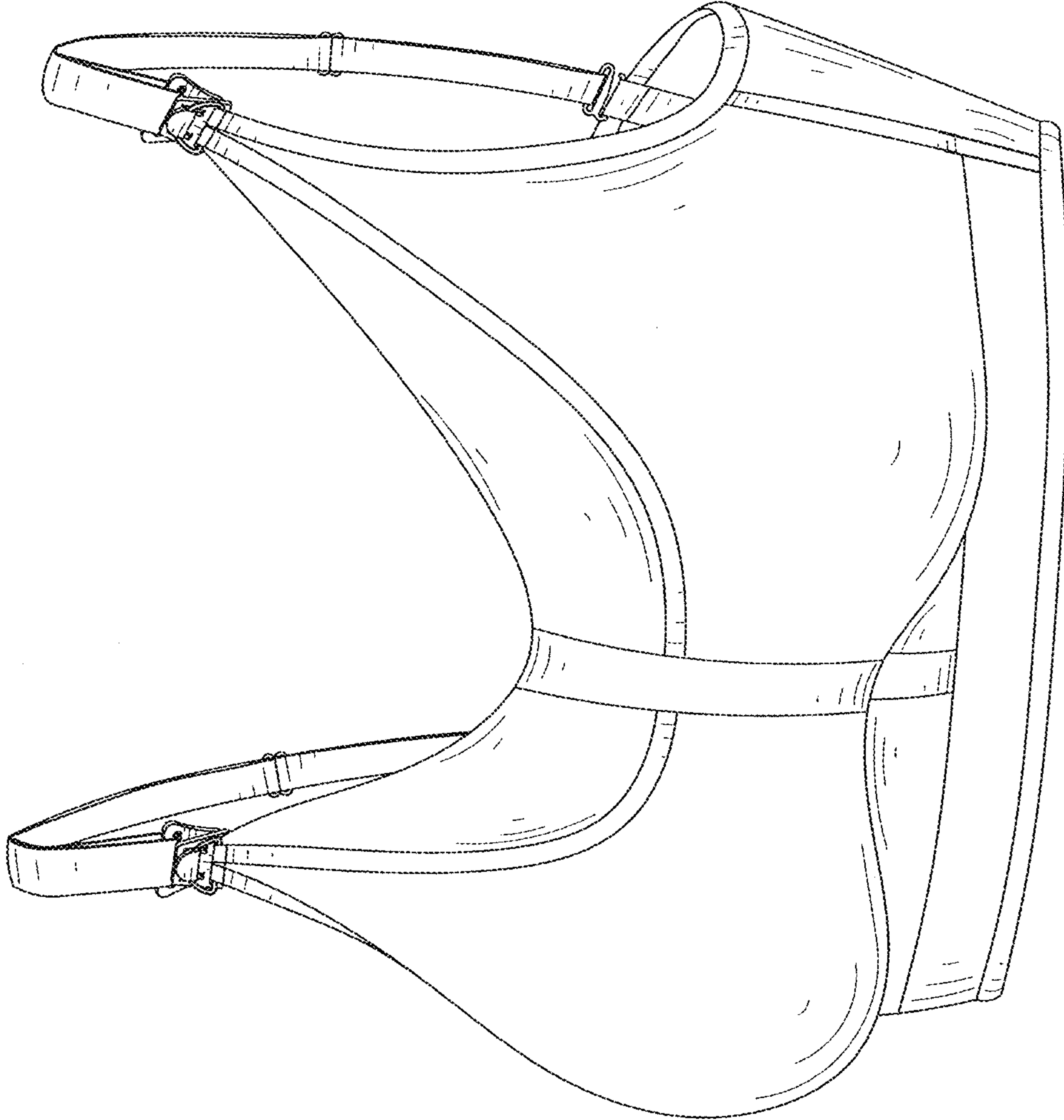

FIG. 1

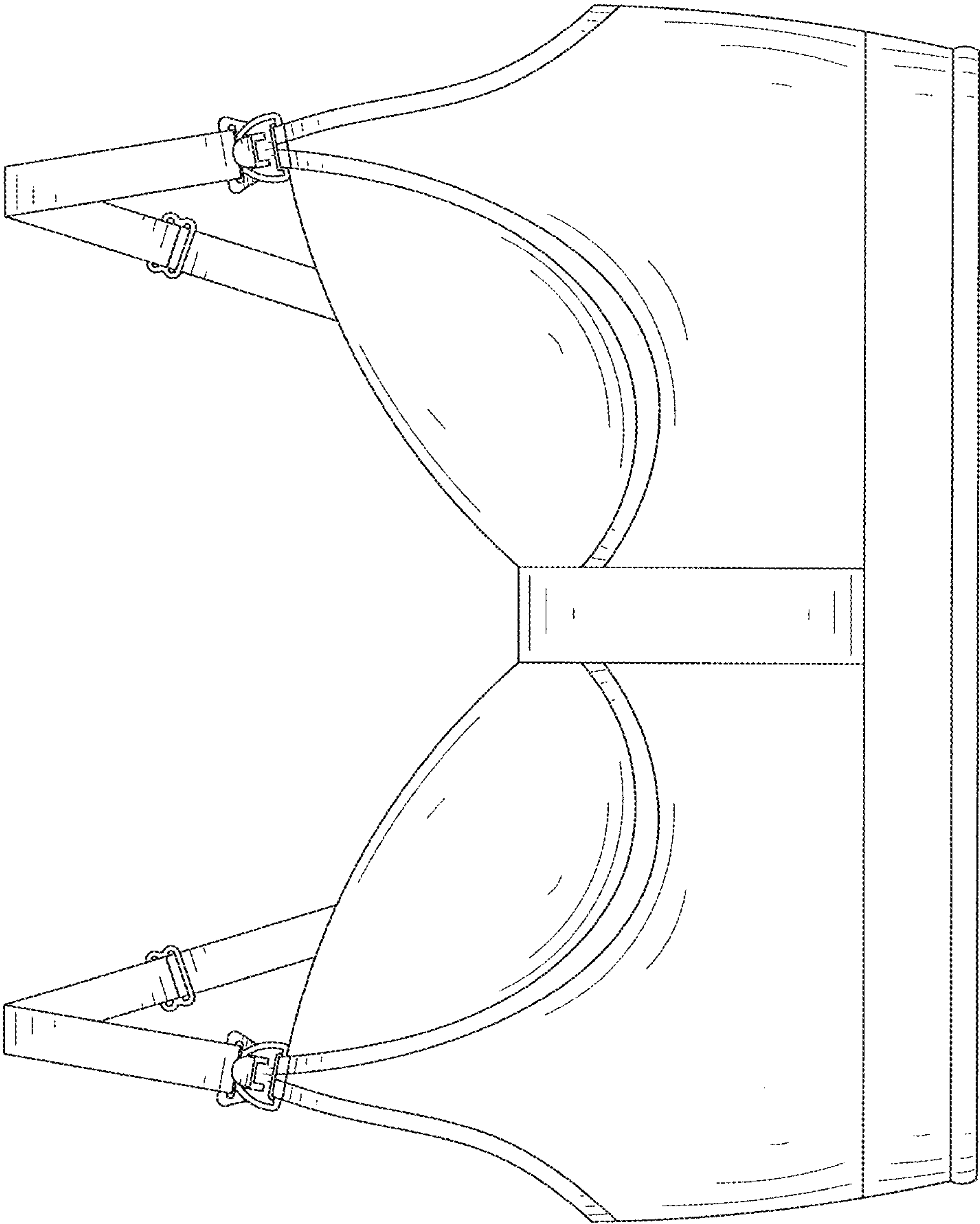

FIG. 2

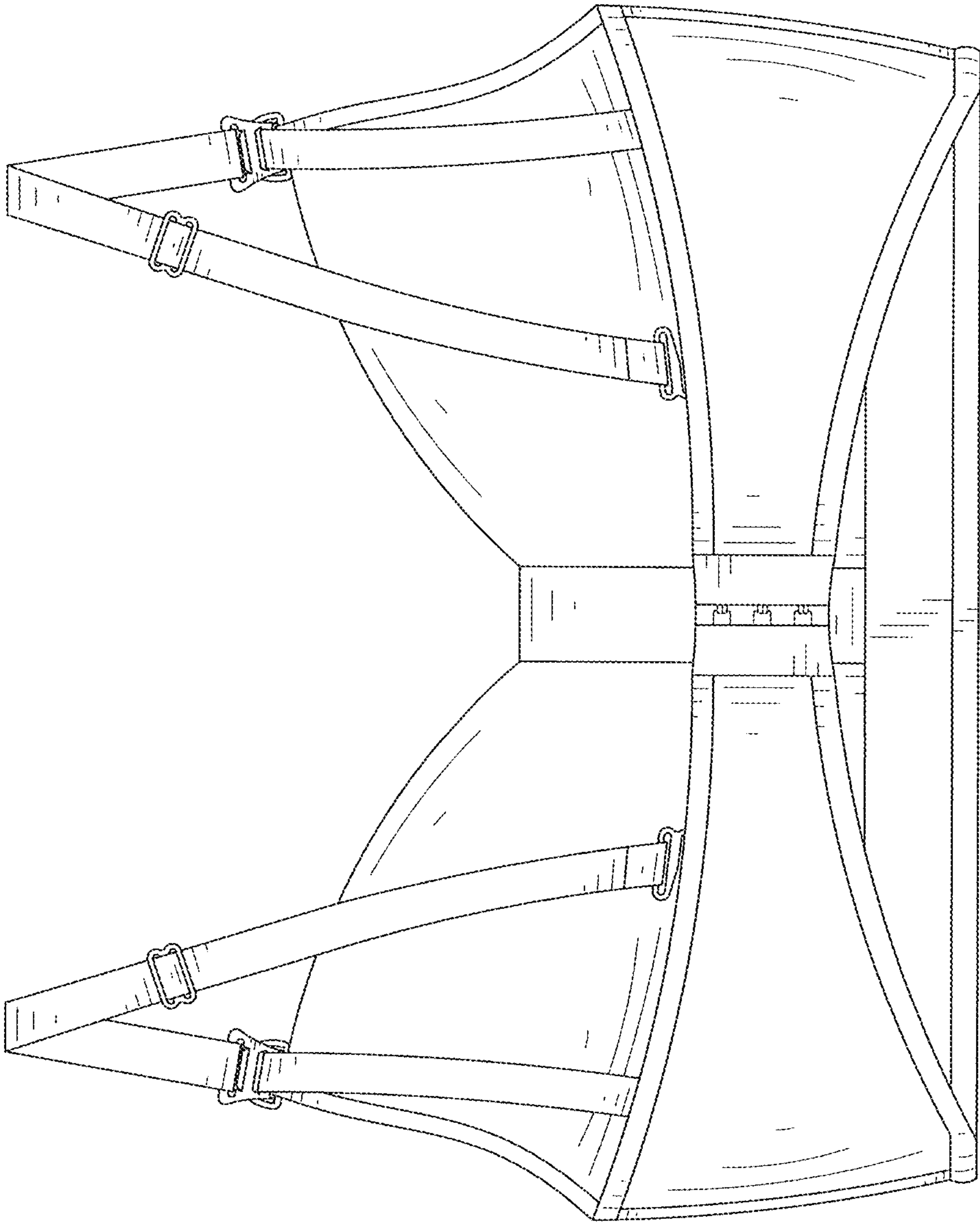

FIG. 3

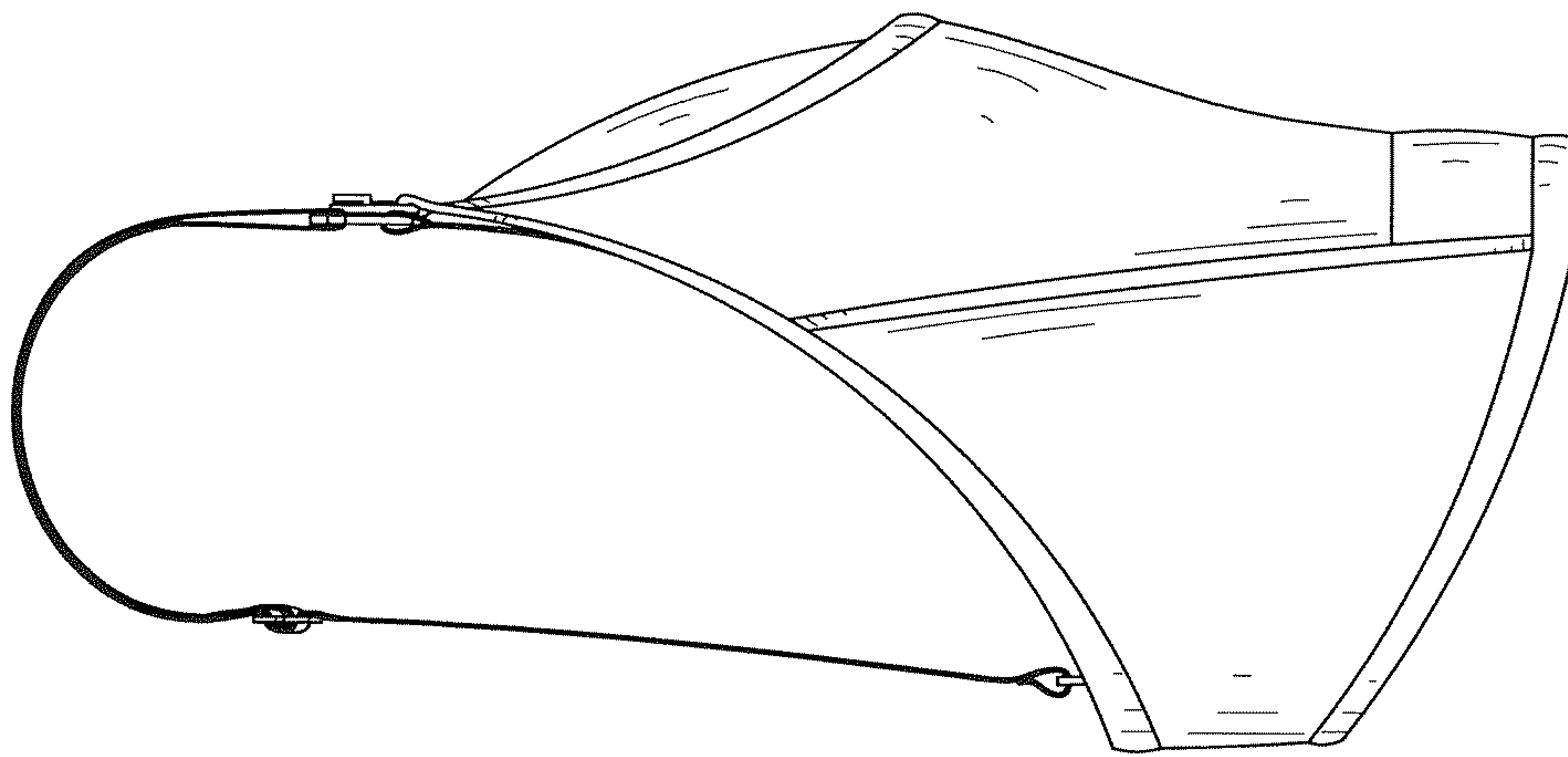

FIG. 4

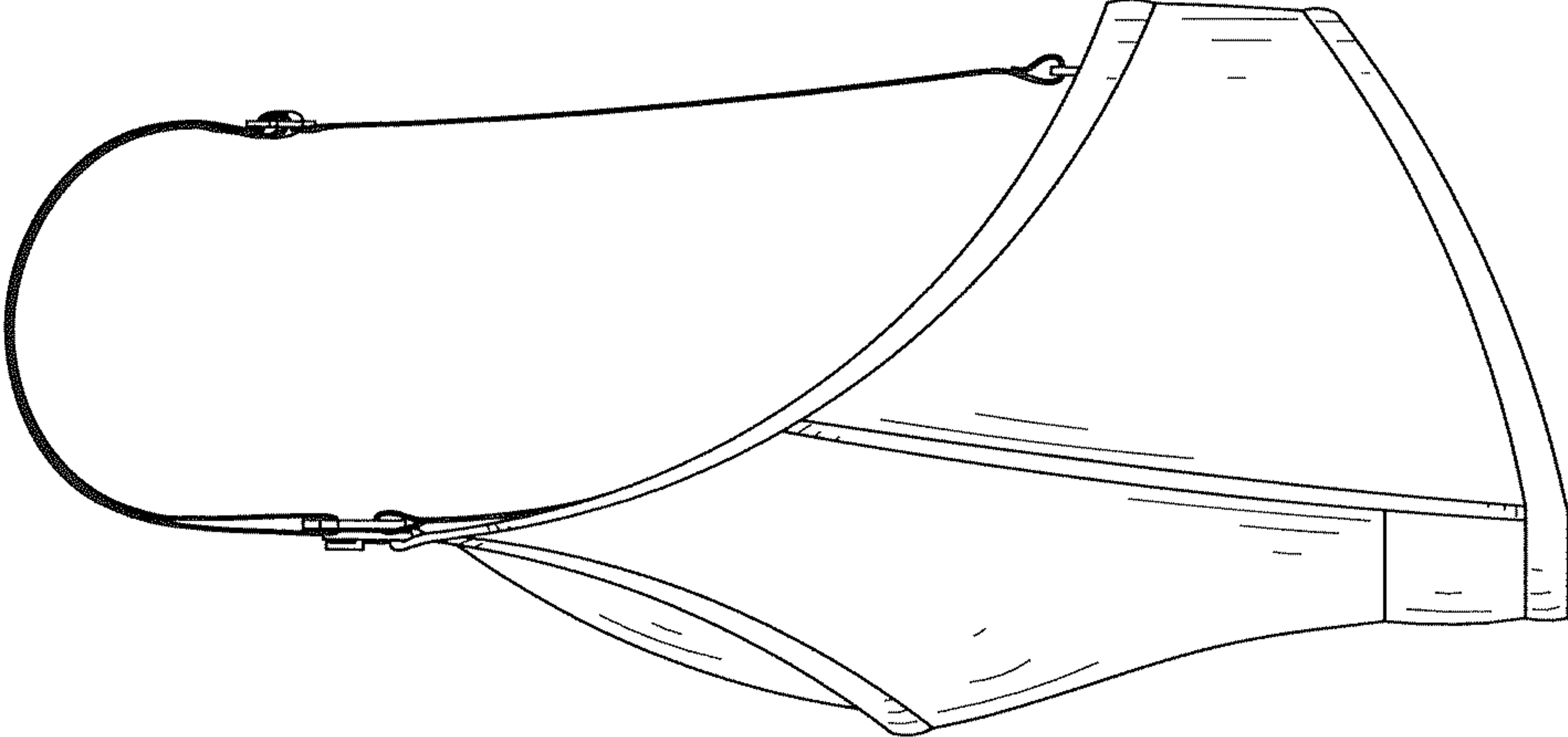

FIG. 5

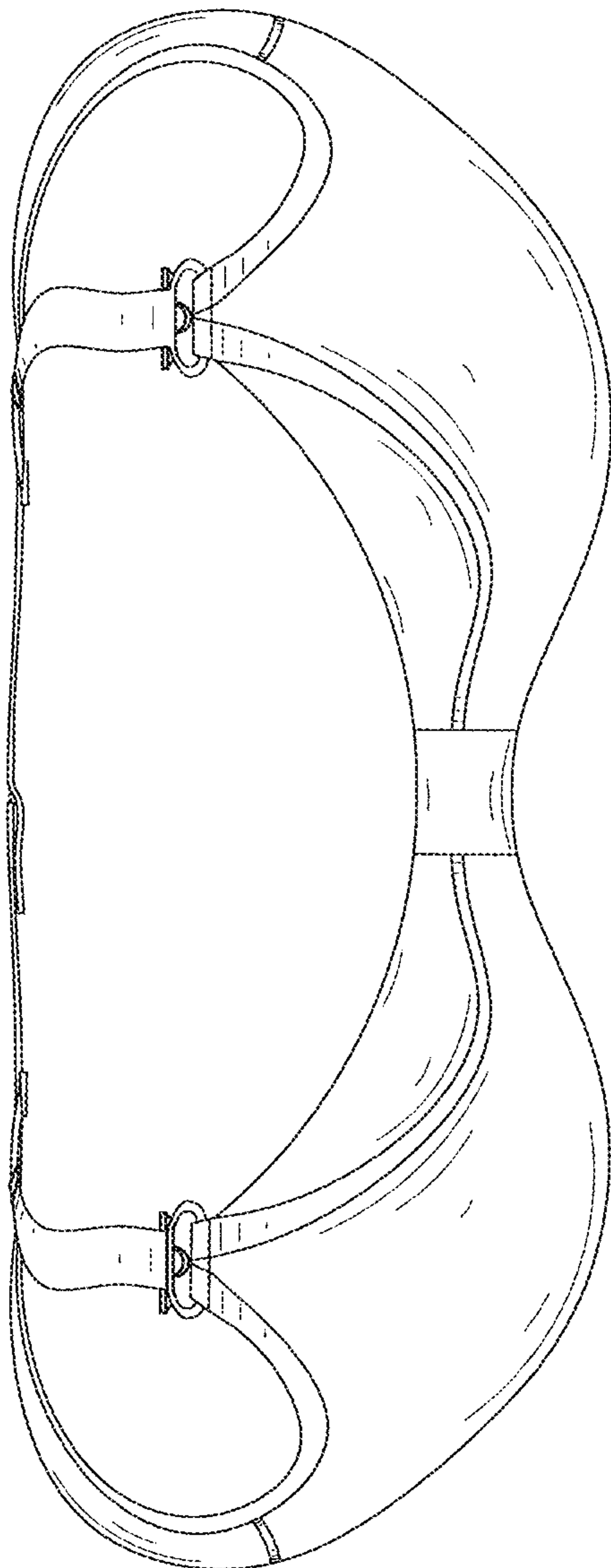

FIG. 6

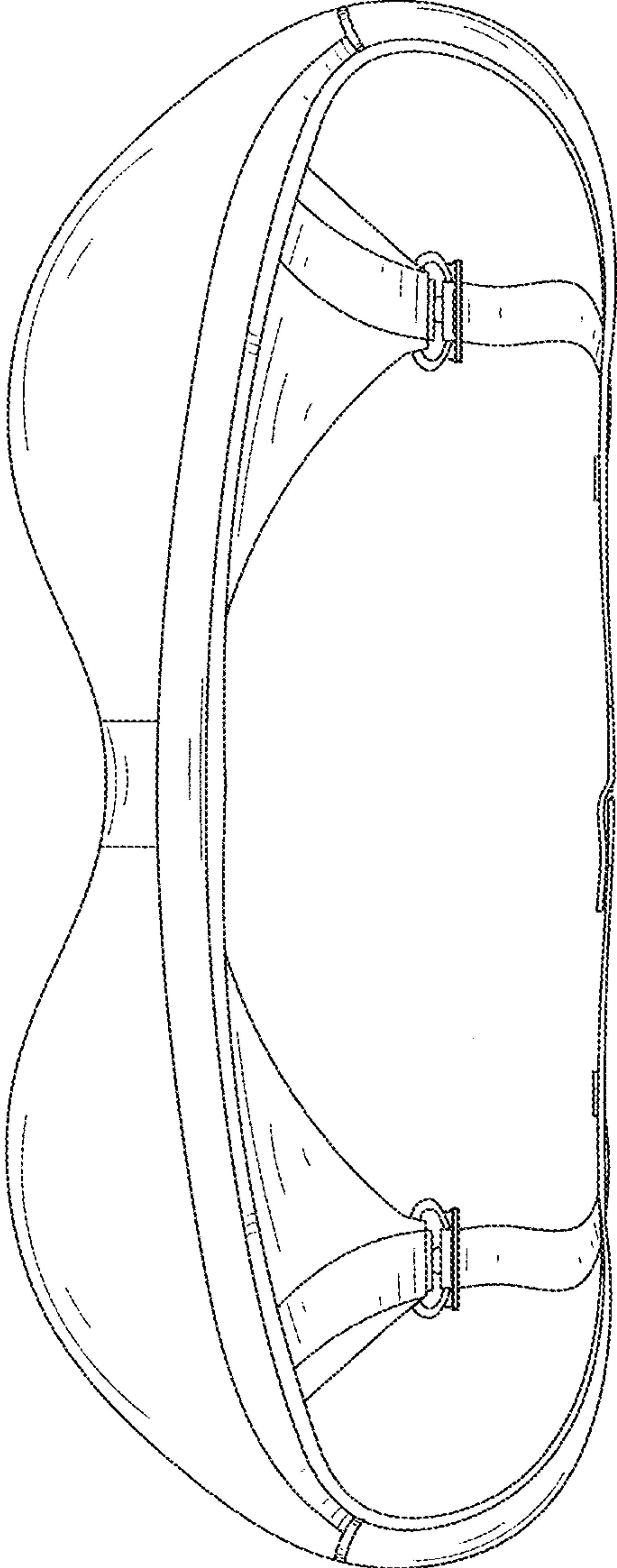

FIG. 7

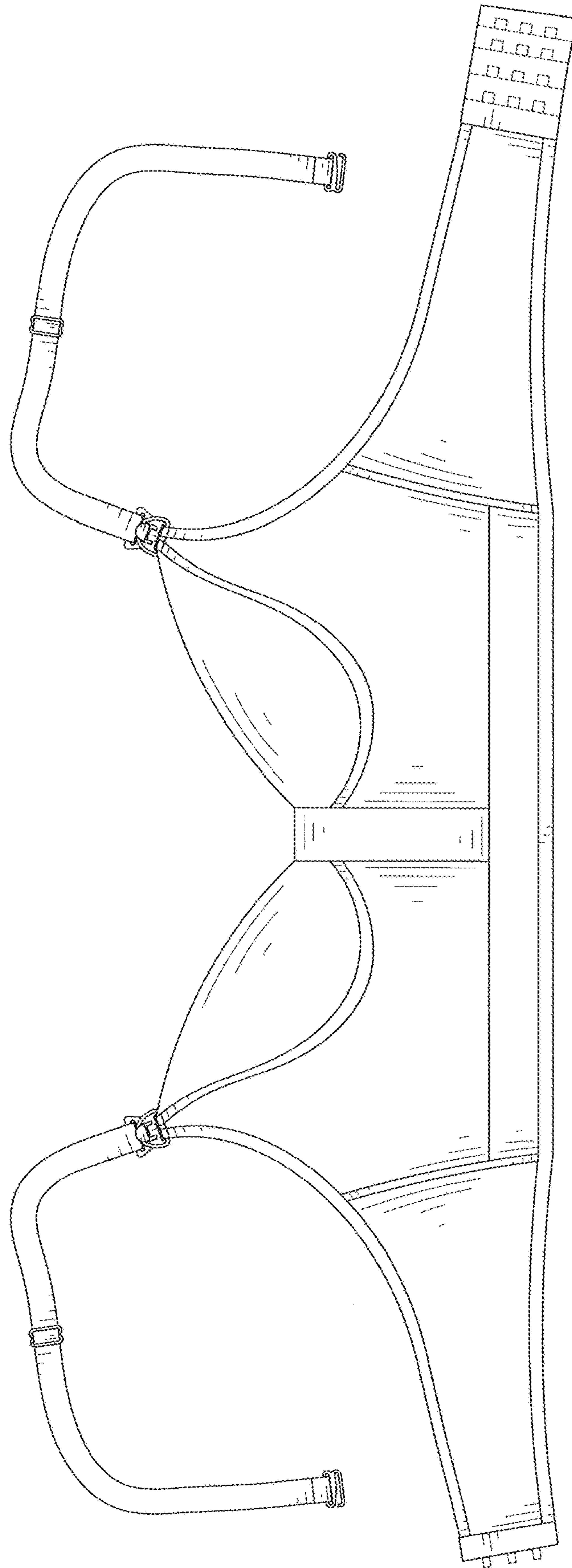

FIG. 8

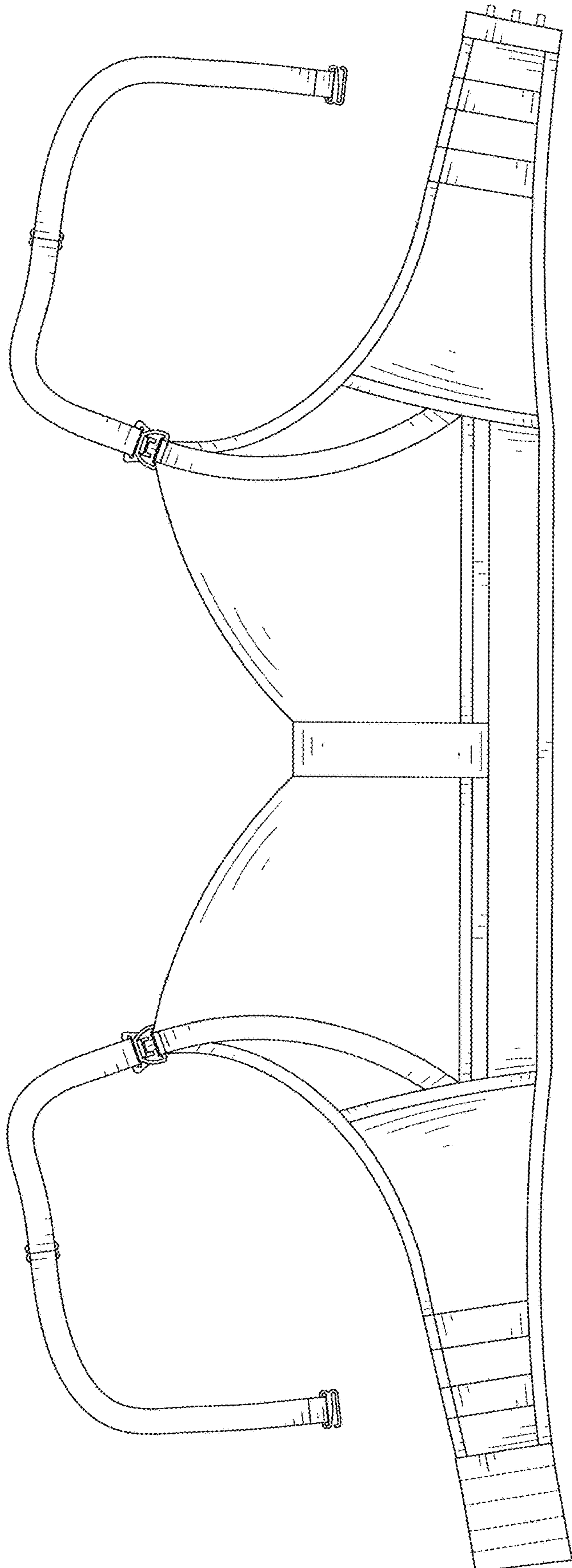

FIG. 9