



US00D940968S

(12) **United States Design Patent**
Ford

(10) **Patent No.: US D940,968 S**
(45) **Date of Patent: ** Jan. 11, 2022**

- (54) **HORSESHOE**
- (71) Applicant: **EASYCARE, INC.**, Durango, CO (US)
- (72) Inventor: **Garrett N Ford**, Durango, CO (US)
- (73) Assignee: **EASYCARE, INC.**, Durango, CO (US)
- (**) Term: **15 Years**
- (21) Appl. No.: **29/731,764**
- (22) Filed: **Apr. 17, 2020**
- (51) **LOC (13) Cl. 30-01**
- (52) **U.S. Cl.**
USPC **D30/147**
- (58) **Field of Classification Search**
USPC D30/144, 145, 146, 147, 148, 150, 151,
D30/199; D2/626, 829, 860, 897, 902,
D2/909, 914, 919, 943, 947, 980;
D24/188, 189, 192; D21/387; D9/650
CPC A01L 3/02; A01L 1/02; A01L 5/00; A01K
13/007; A01K 13/006
See application file for complete search history.

- 2012/0118587 A1* 5/2012 Patek A01K 13/007
168/4
- 2014/0231100 A1* 8/2014 Ford A01L 1/02
168/12
- 2015/0327531 A1* 11/2015 Hannover A01L 1/04
168/10

OTHER PUBLICATIONS

“EasyCare: EasyShoe Flex with Heart Bar”. Found online May 28, 2019 at easycareinc.com. Reference dated May 28, 2019. Retrieved from <https://www.easycareinc.com/easyshoe/EasyShoe-Flex-Heart-Bar.asp>.*

“Grand Circuit: Horseshoes, Aluminum/ Heart Bars”. Found online May 28, 2019 at grandcircuitinc.com. Reference dated May 30, 2015. Retrieved from <https://web.archive.org/web/20150530145133/https://www.grandcircuitinc.com/catalog/horseshoes-aluminum/heart-bars>.*

(Continued)

Primary Examiner — Kendra Leslie Hamilton

(57) **CLAIM**

The ornamental design for a horseshoe, as shown and described.

(56) **References Cited**

U.S. PATENT DOCUMENTS

- 1,447,153 A * 2/1923 Sala A01L 1/02
168/29
- D230,284 S * 2/1974 Shenton et al. D30/148
- D257,693 S * 12/1980 Poust, Sr D30/148
- D612,550 S * 3/2010 Justis D30/147
- D644,271 S * 8/2011 Osborne D21/387
- D671,279 S * 11/2012 Lander D30/146
- D876,030 S * 2/2020 Blair D30/147
- 2003/0217851 A1* 11/2003 Forstner A01L 3/00
168/4
- 2005/0217870 A1* 10/2005 Kolonia A01L 5/00
168/4
- 2007/0033909 A1* 2/2007 Lustgarten A01L 7/00
54/82

DESCRIPTION

FIG. 1 is a top left perspective view of a horseshoe showing my new design;
 FIG. 2 is a rear elevational view thereof;
 FIG. 3 is a front elevational view thereof;
 FIG. 4 is a left side elevational view thereof;
 FIG. 5 is a right side elevational view thereof;
 FIG. 6 is a top plan view thereof; and,
 FIG. 7 is a bottom view thereof.

In the drawings, the broken lines depict environmental structure and form no part of the claimed design.

1 Claim, 5 Drawing Sheets

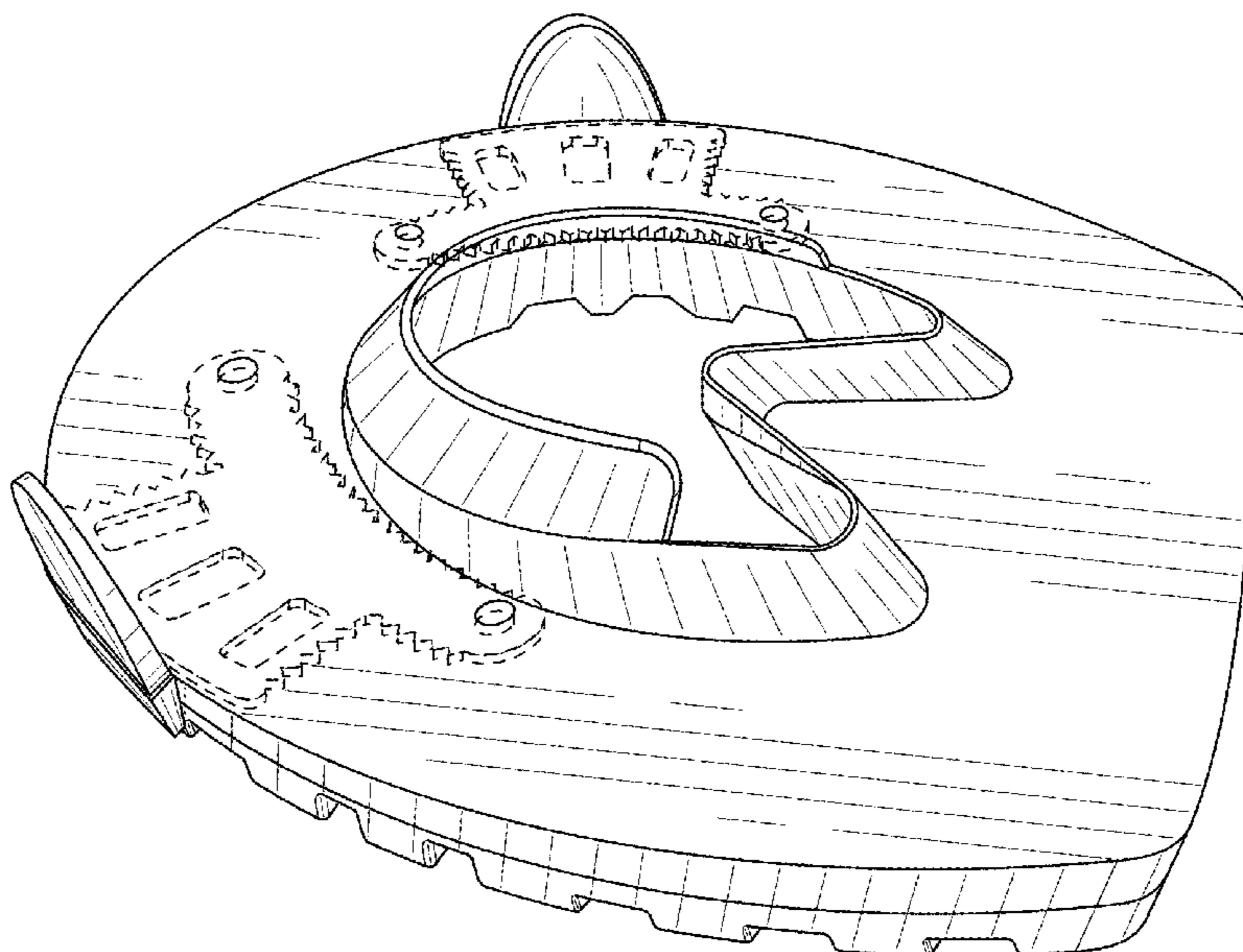

(56)

References Cited

OTHER PUBLICATIONS

“Farrier’s Journal: Non-Metal Horseshoes & Boots Product Roundup 2014”. Found online May 16, 2016 at americanfarriers.com. Reference dated Nov. 10, 2014. Retrieved from <https://www.americanfarriers.com/articles/120-non-metal-horseshoes-boots-product-roundup-2014>.*

“FormaHoof: Barefoot Shoe”. Found online Jun. 24, 2019 at instagram.com. Reference dated Oct. 21, 2017. Retrieved from https://www.instagram.com/p/BahlUOUgEh_.*

* cited by examiner

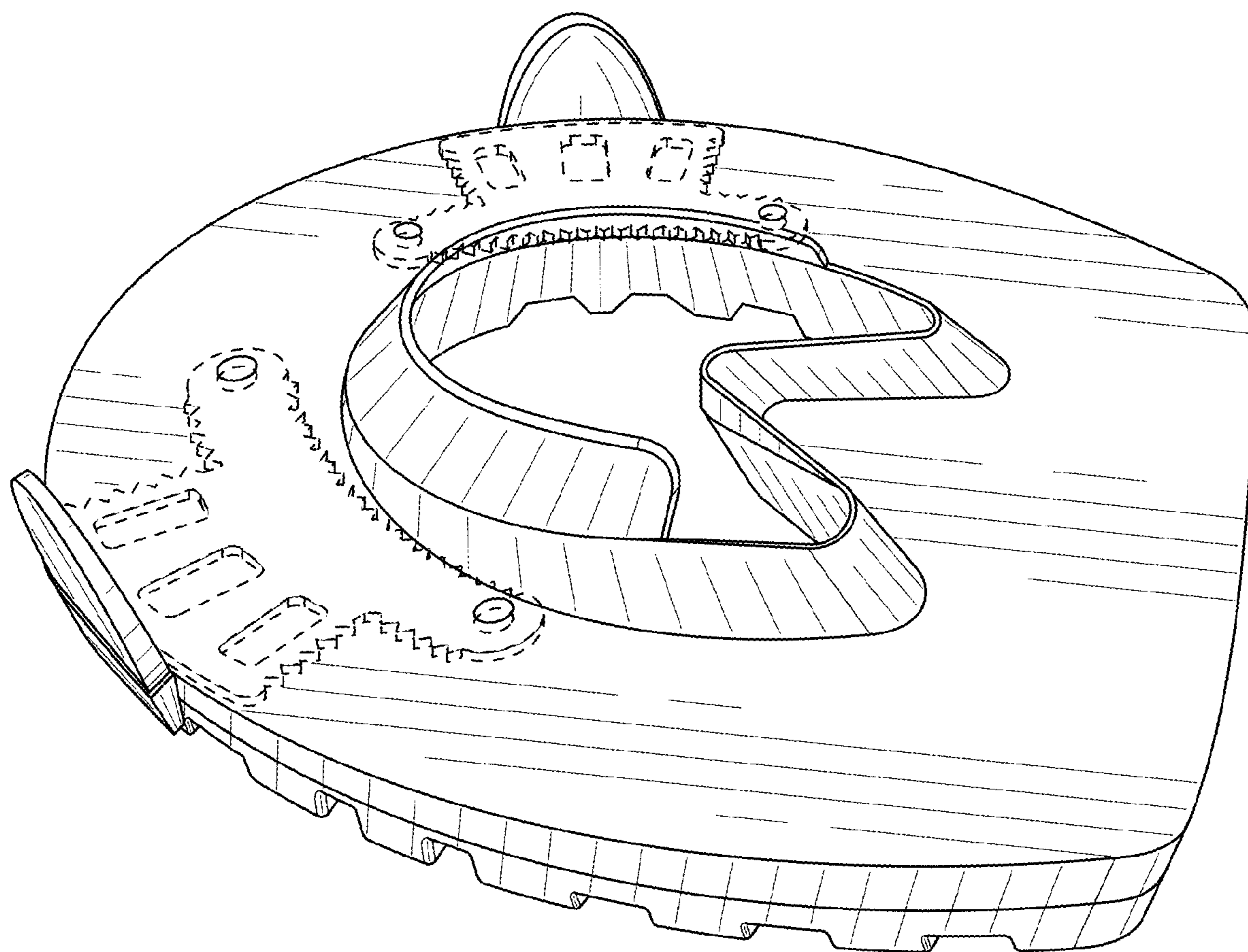

FIG. 1

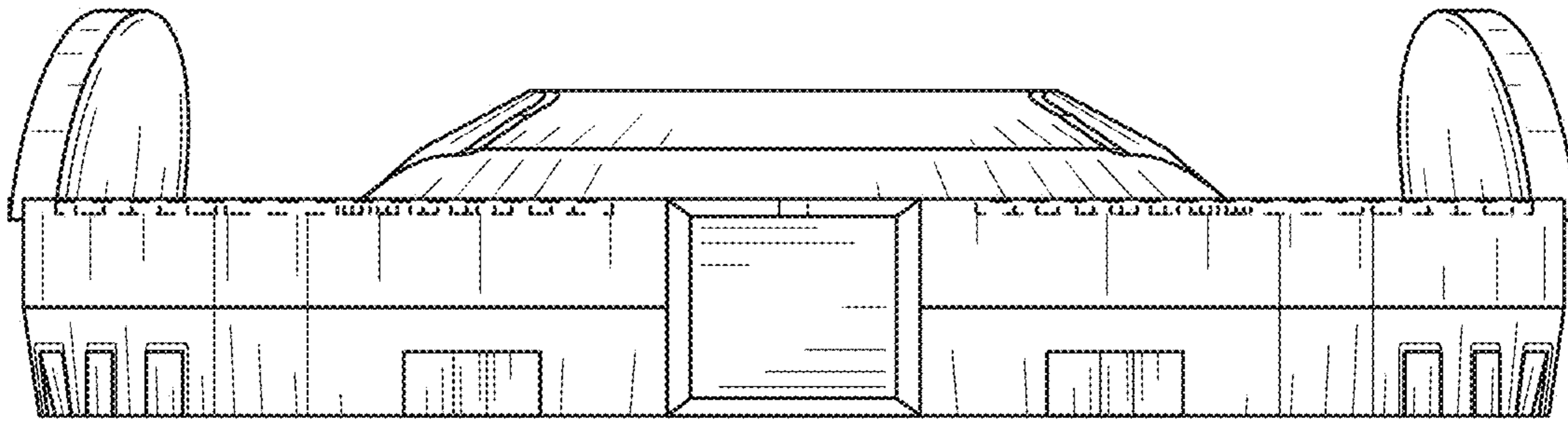

FIG. 2

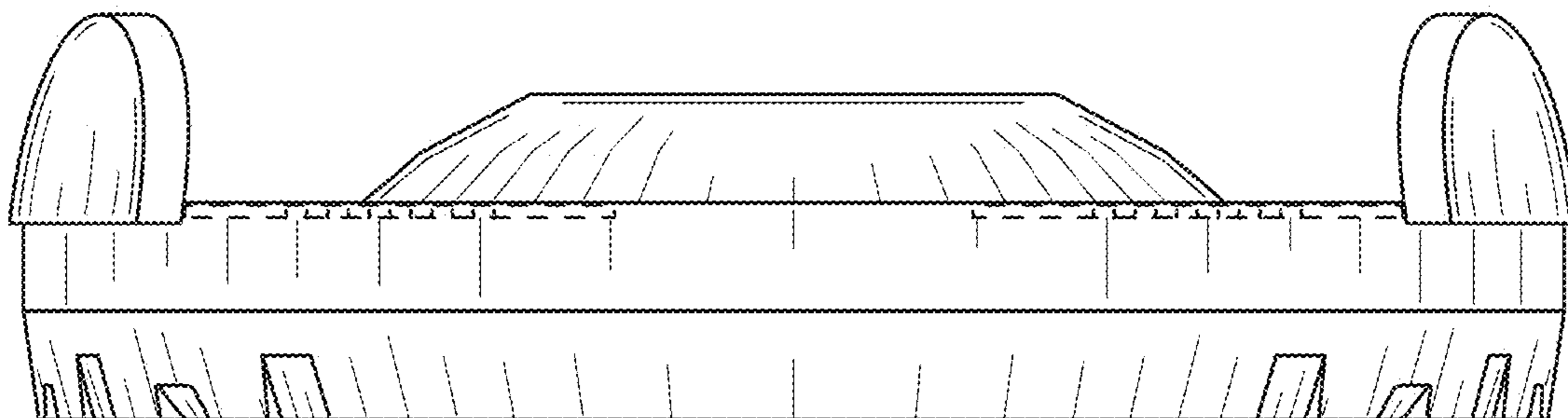

FIG. 3

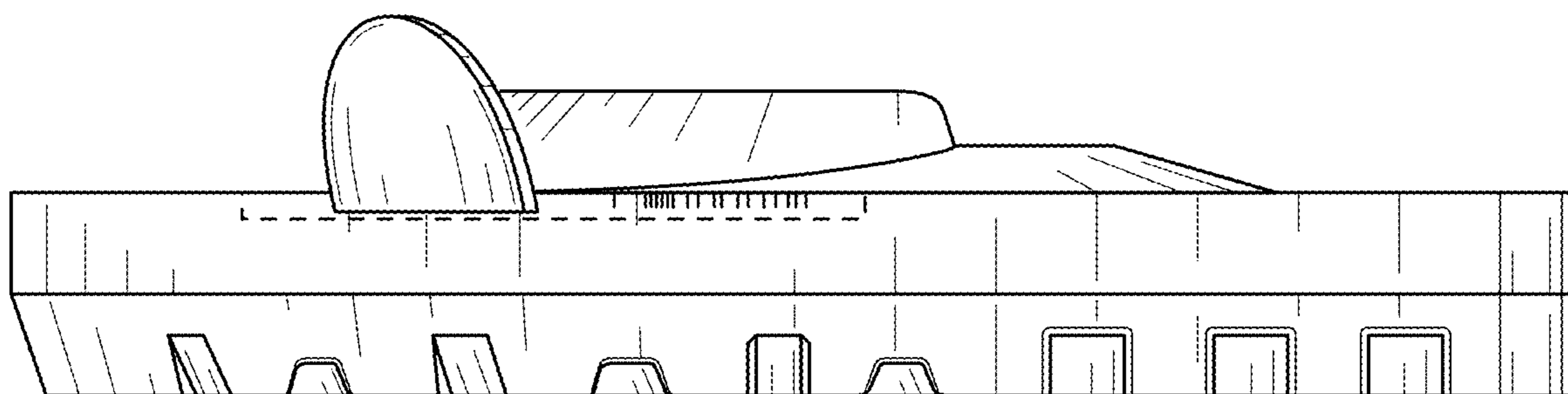

FIG. 4

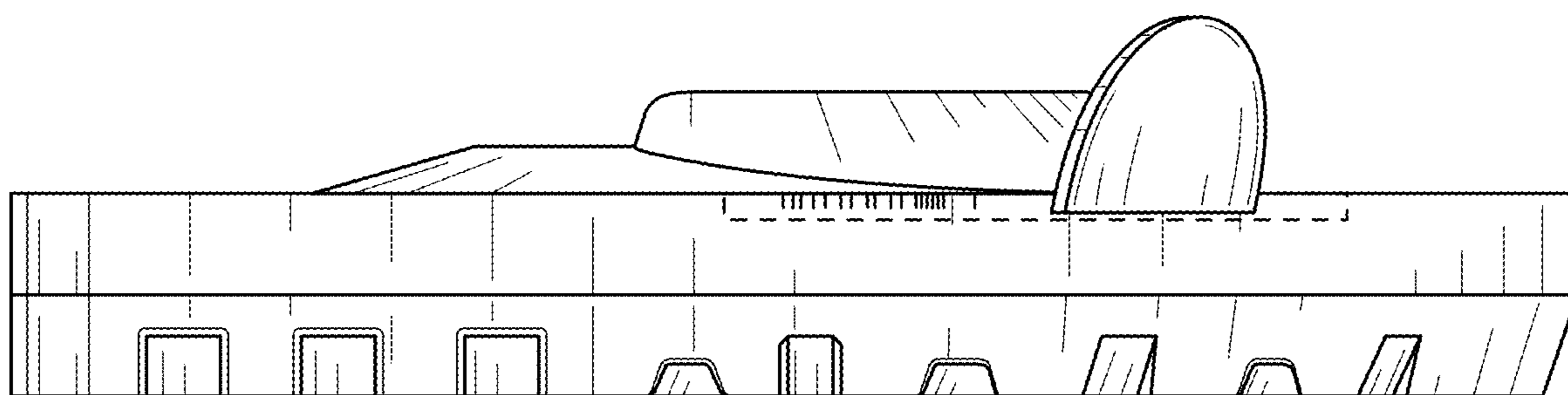

FIG. 5

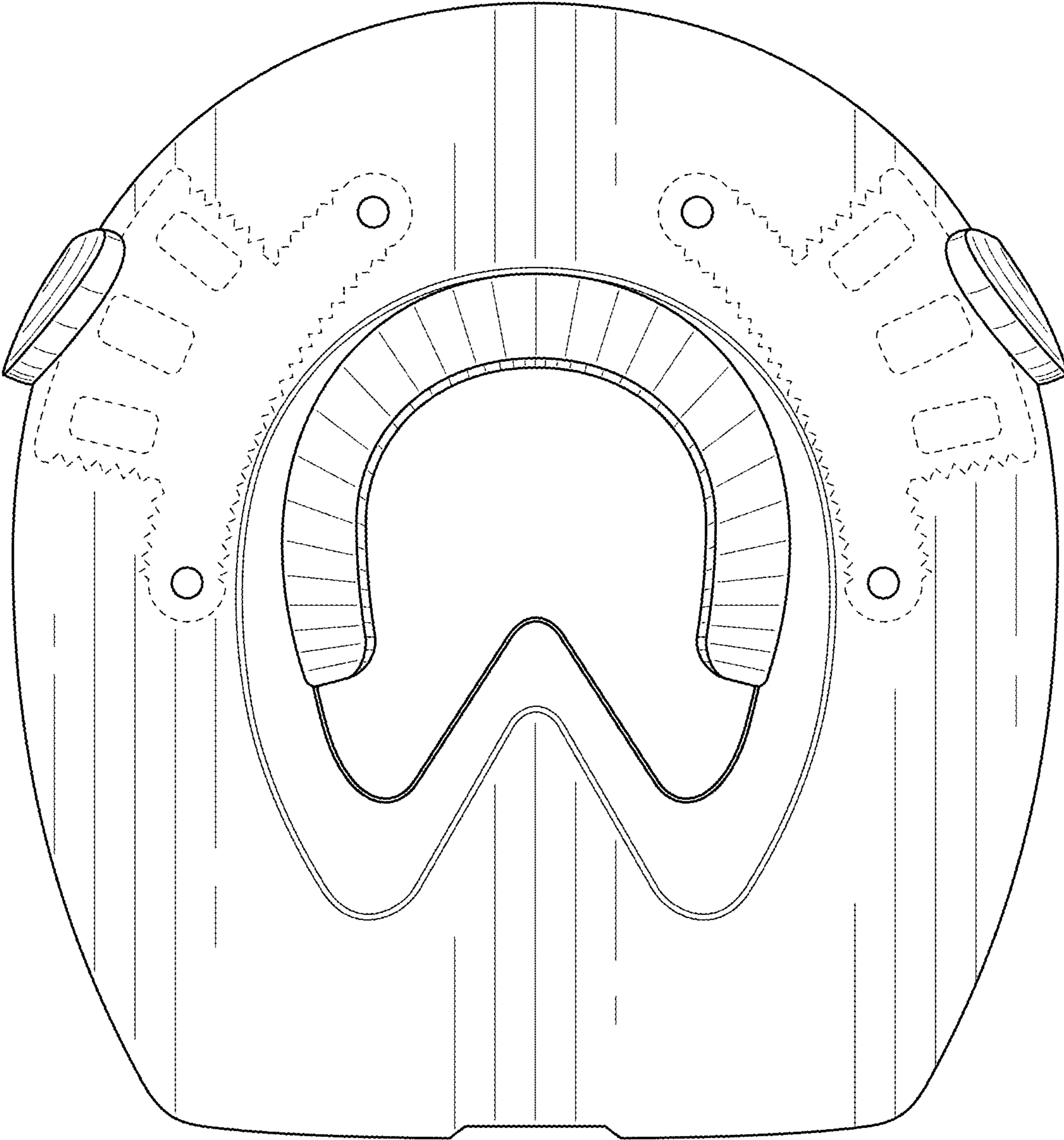

FIG. 6

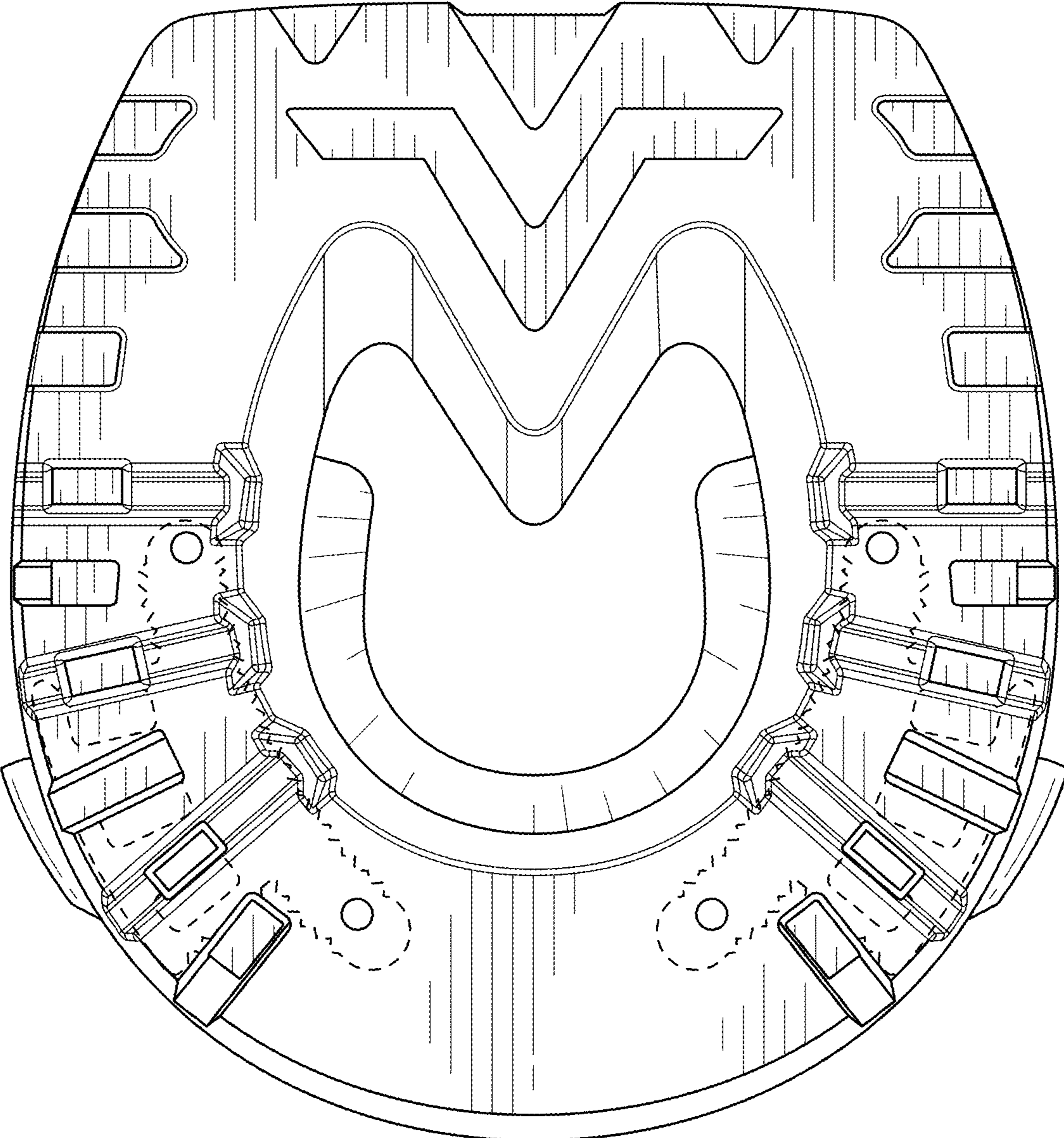

FIG. 7