



US00D940943S

(12) **United States Design Patent** (10) **Patent No.:** **US D940,943 S**
Sieczkowski (45) **Date of Patent:** **** Jan. 11, 2022**

(54) **LIGHT FIXTURE**

(71) Applicant: **ABL IP Holding LLC**, Atlanta, GA
(US)

(72) Inventor: **Philip Sieczkowski**, Lawrenceville, GA
(US)

(73) Assignee: **ABL IP Holding LLC**, Atlanta, GA
(US)

(**) Term: **15 Years**

(21) Appl. No.: **29/678,481**

(22) Filed: **Jan. 29, 2019**

(51) **LOC (13) Cl.** **26-05**

(52) **U.S. Cl.**
USPC **D26/74**

(58) **Field of Classification Search**
USPC D26/74, 72, 75, 76, 77, 78, 85, 88, 89,
D26/118, 138, 141, 67, 70; 362/364,
362/365, 373, 145, 146, 147, 148, 150,
362/153, 153.1, 294, 296.01, 296.07,
362/296.08
CPC F21V 29/2262; F21V 7/06; F21V 21/044;
F21V 21/047; F21V 29/2212; F21V
29/2225; F21V 29/2256; F21V 29/225;
F21V 29/2268; F21Y 2111/002; F21S
8/02; F21S 8/026

See application file for complete search history.

(56) **References Cited**

U.S. PATENT DOCUMENTS

D373,212 S *	8/1996	Clark	D26/74
D379,453 S *	5/1997	Fabrizi	D13/156
D512,433 S *	12/2005	Korpai	D14/450
7,686,469 B2	3/2010	Ruud et al.		

D690,868 S *	10/2013	Mayfield, III	D26/74
D691,096 S *	10/2013	Beroukas	D13/162
D695,442 S *	12/2013	Speier	D26/74
D721,740 S *	1/2015	Schmaltz	D15/28
D763,929 S *	8/2016	Schmaltz	D15/28
D809,696 S *	2/2018	Wheatley	D26/74
D819,860 S *	6/2018	Clark	D26/76
D827,917 S *	9/2018	Botti	D26/138
D853,617 S *	7/2019	Eberts	D26/74
D886,900 S *	6/2020	Frank	D18/12.3
2016/0377247 A1	12/2016	Chang		

* cited by examiner

Primary Examiner — Angela J Lee

(74) *Attorney, Agent, or Firm* — Kilpatrick Townsend & Stockton LLP

(57) **CLAIM**

The ornamental design for a light fixture, as shown and described.

DESCRIPTION

FIG. 1 is a top, front isometric view of a light fixture.
 FIG. 2 is a top, rear isometric view of the light fixture of FIG. 1.
 FIG. 3 is a front view of the light fixture of FIG. 1.
 FIG. 4 is a top view of the light fixture of FIG. 1.
 FIG. 5 is a bottom view of the light fixture of FIG. 1.
 FIG. 6 is a left side view of the light fixture of FIG. 1.
 FIG. 7 is a right side view of the light fixture of FIG. 1.
 FIG. 8 is a rear view of the light fixture of FIG. 1.
 FIG. 9 is a bottom, front isometric view of the light fixture of FIG. 1; and,
 FIG. 10 is a bottom, rear isometric view of the light fixture of FIG. 1.
 The broken lines in the drawings are for illustrative purposes only and form no part of the claimed design.

1 Claim, 8 Drawing Sheets

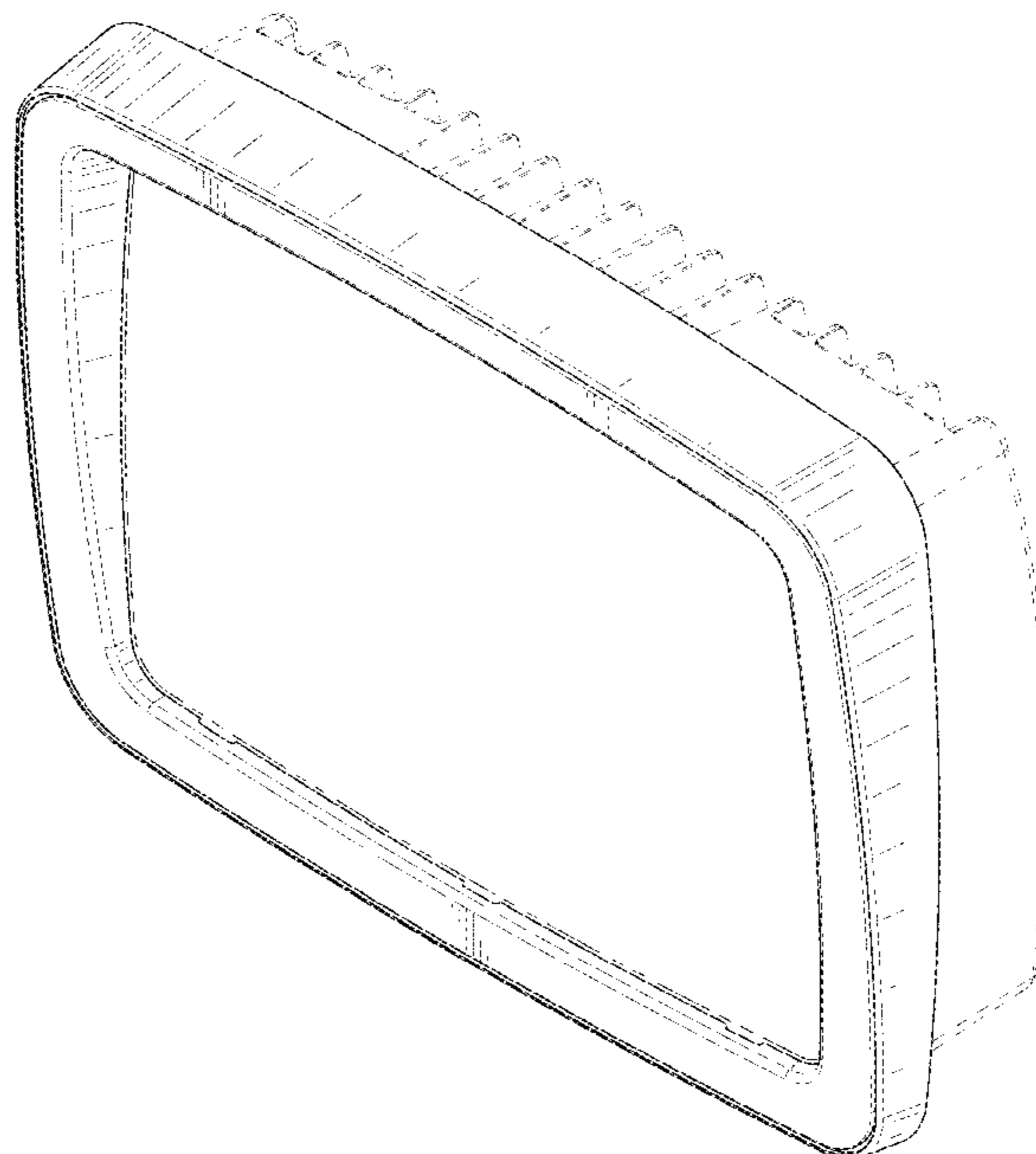

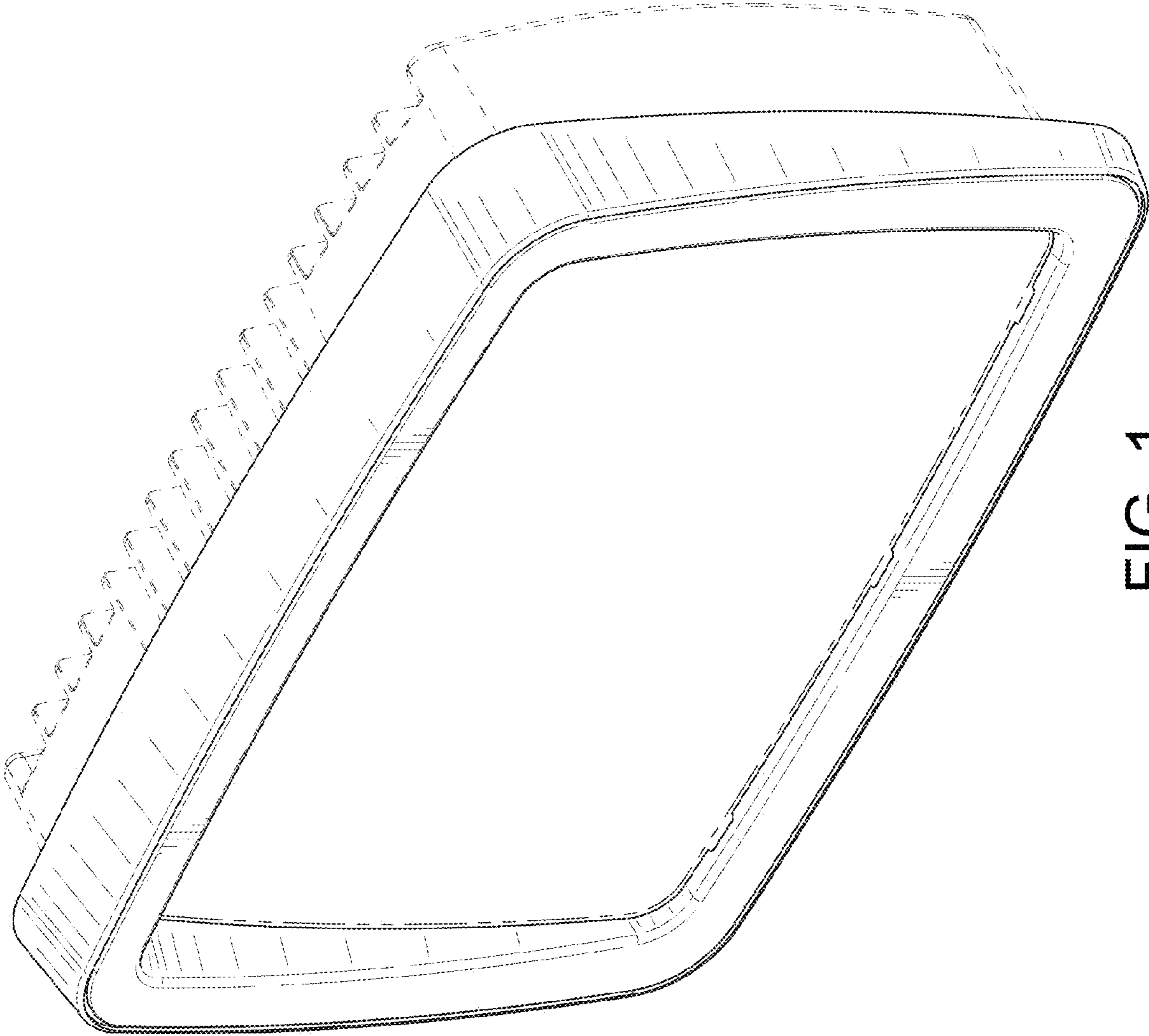

FIG. 1

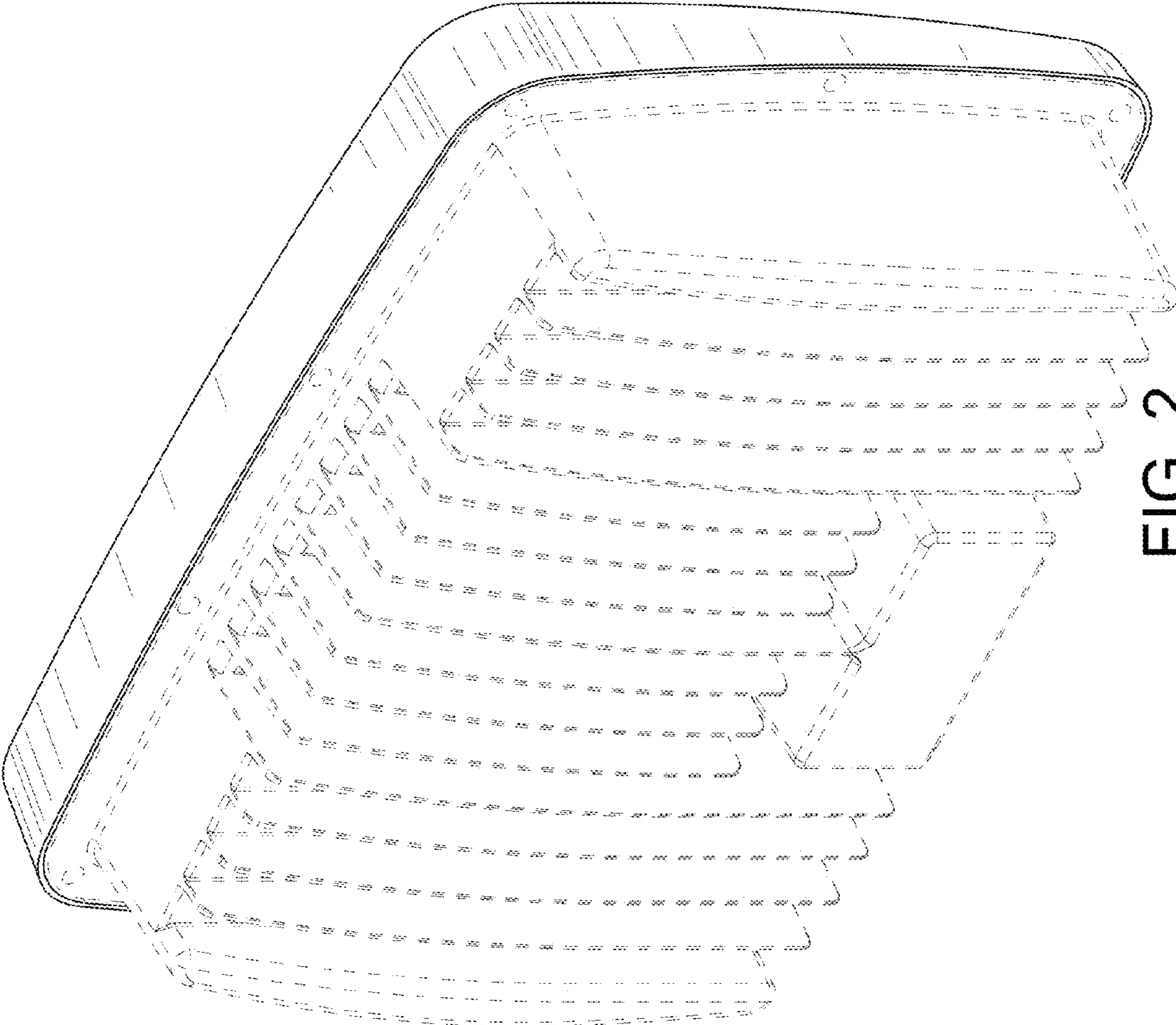

FIG. 2

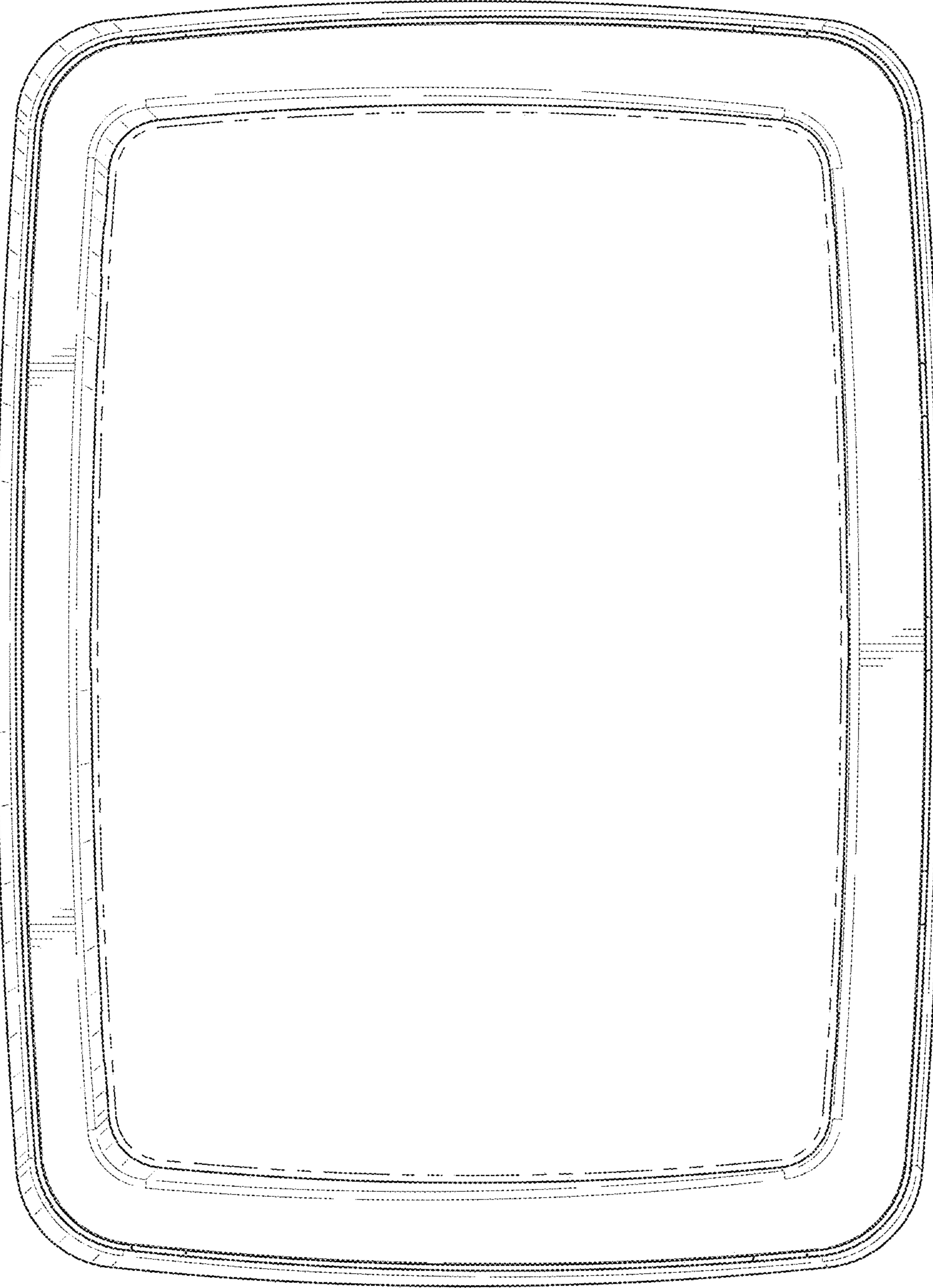

FIG. 3

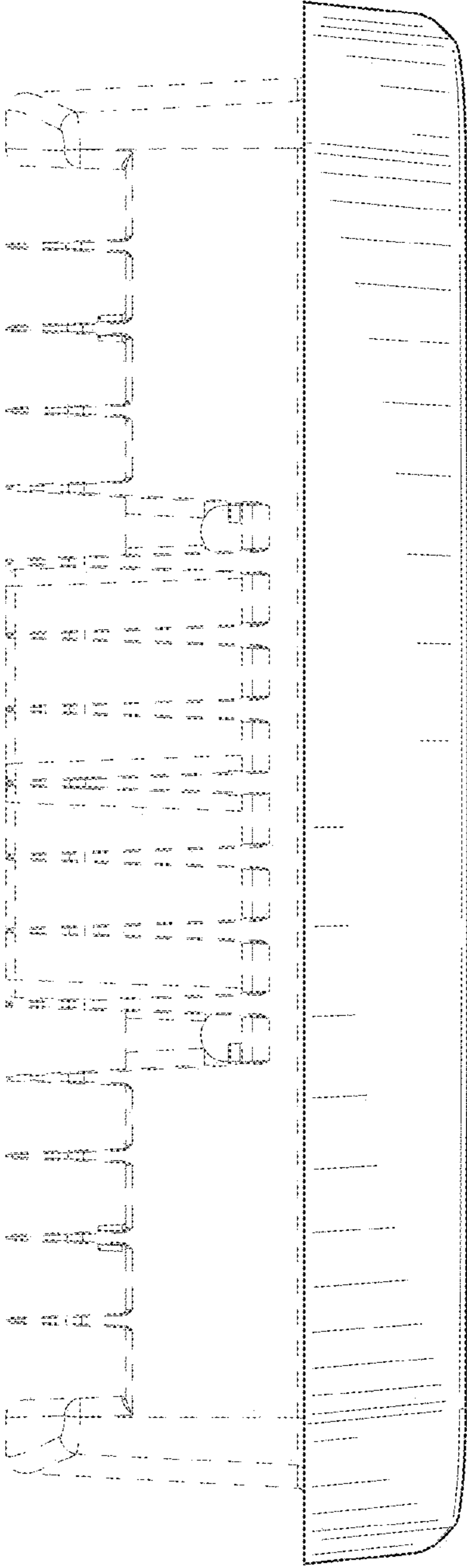

FIG. 4

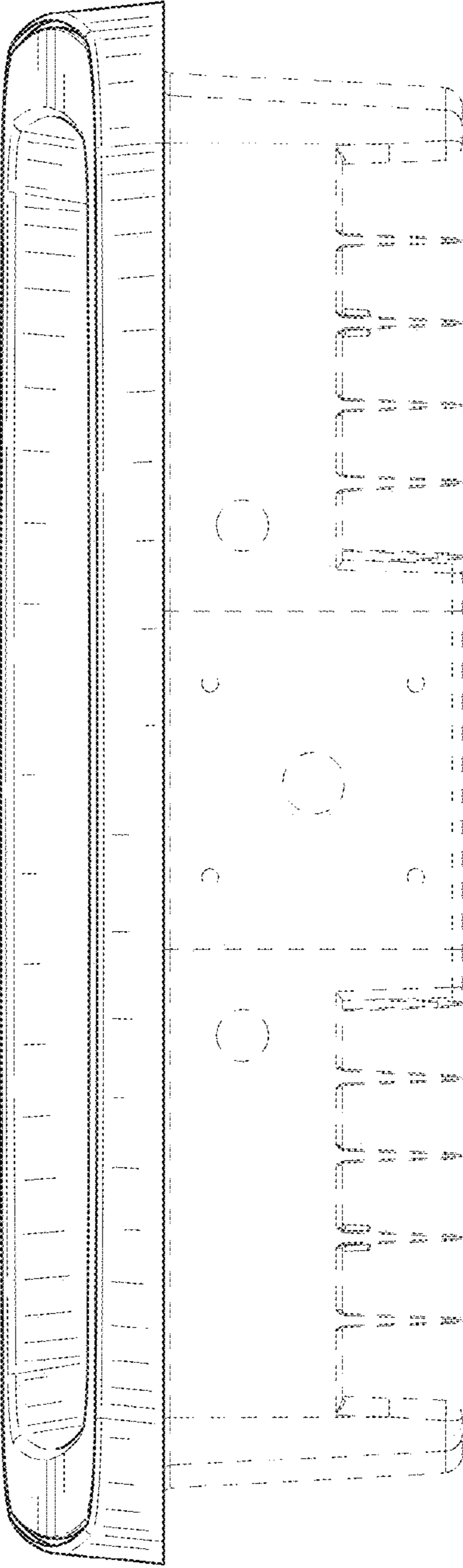

FIG. 5

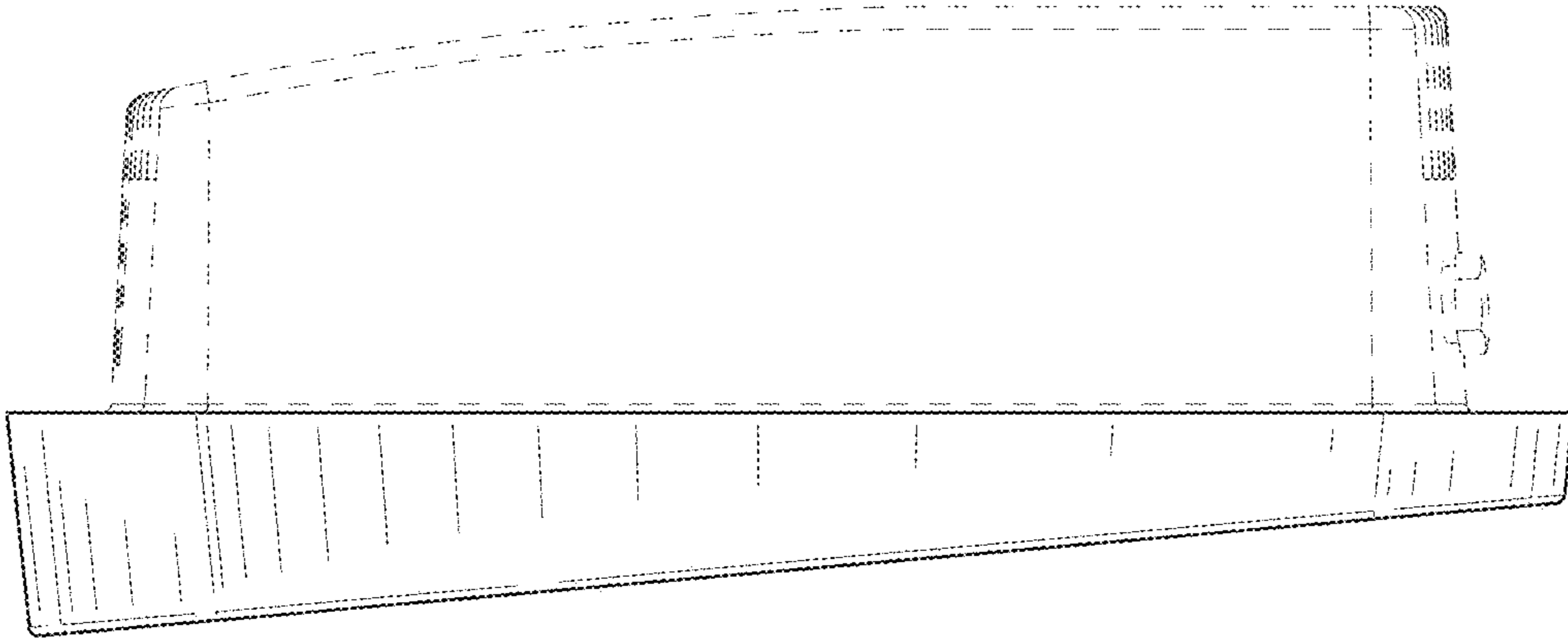

FIG. 7

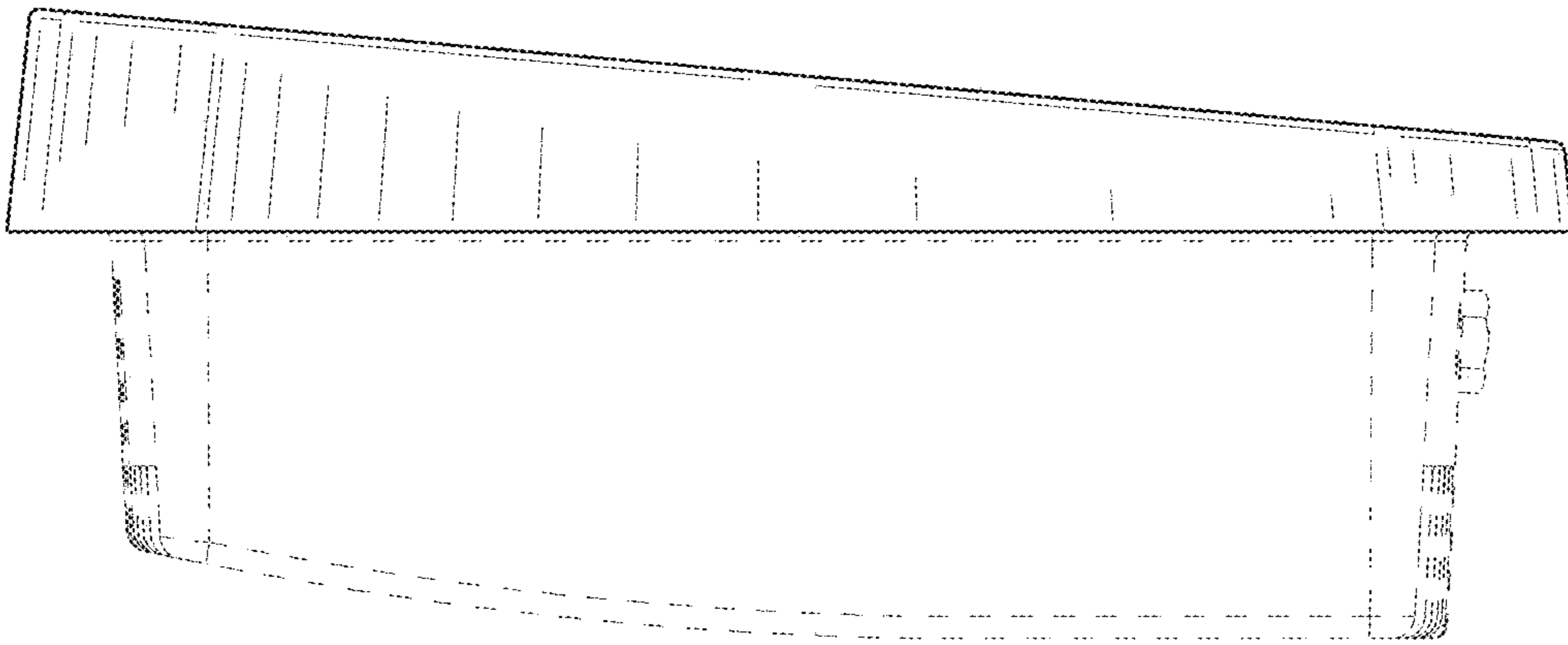

FIG. 6

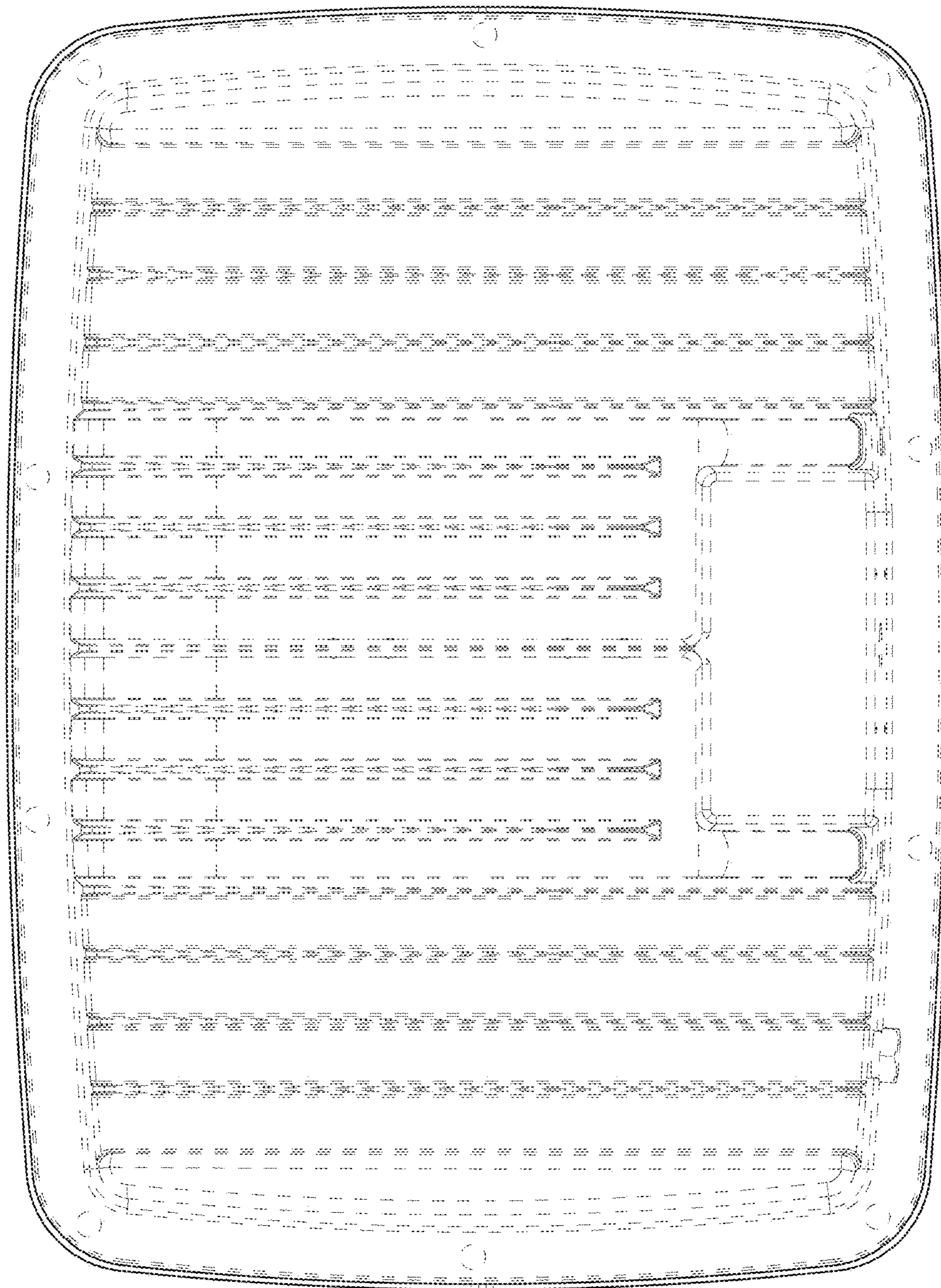

FIG. 8

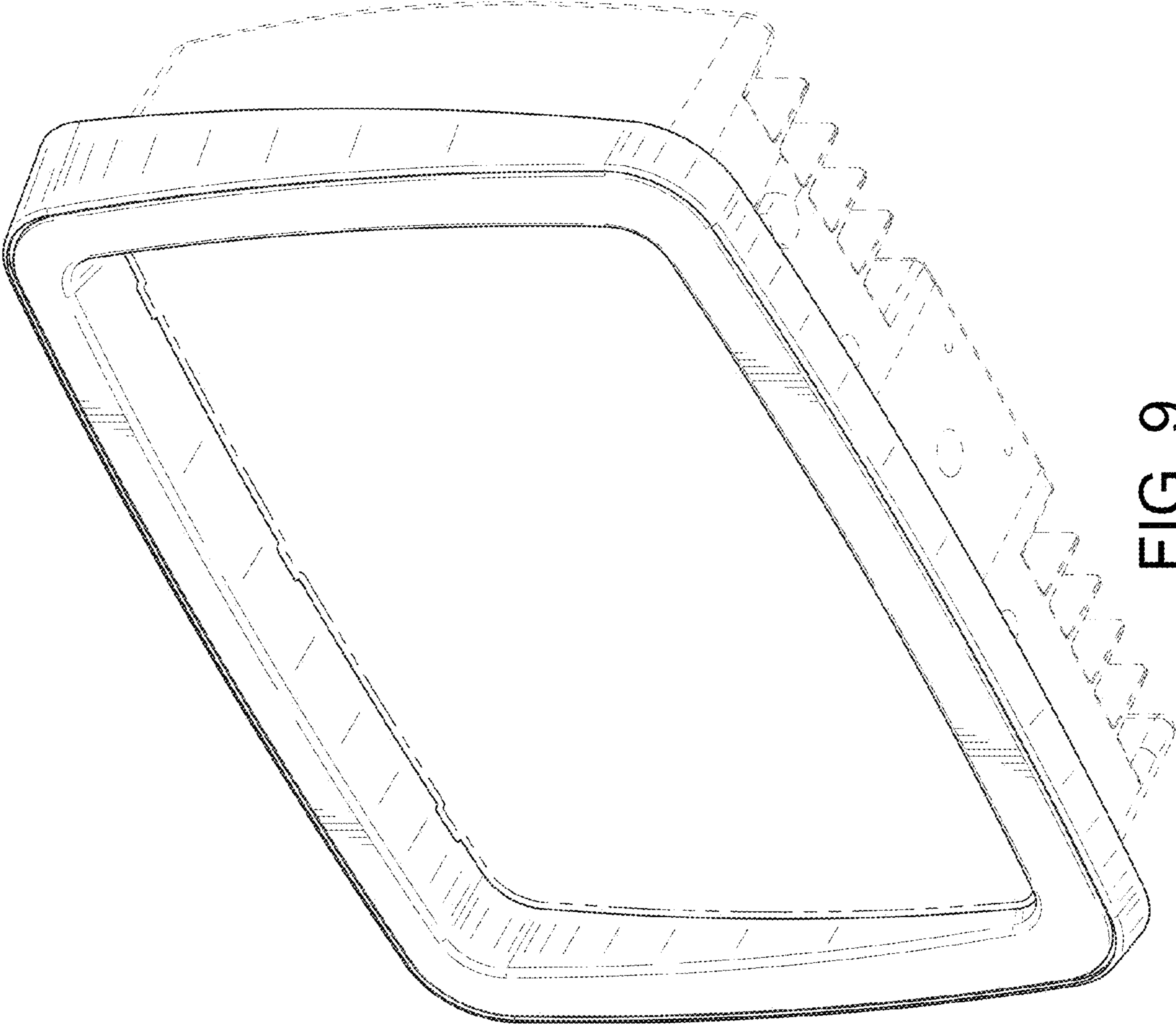

FIG. 9

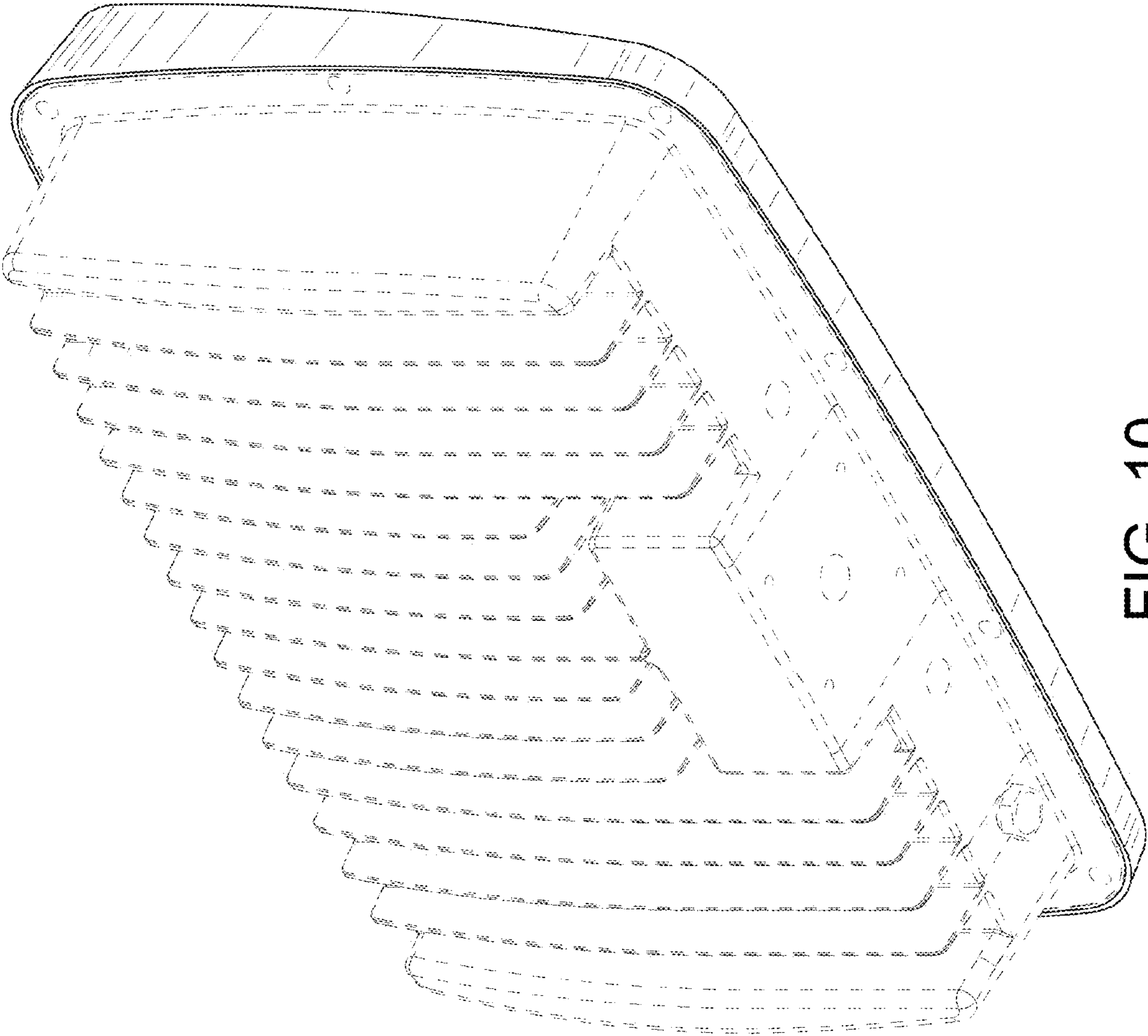

FIG. 10