

US00D940942S

(12) **United States Design Patent**
Zou

(10) **Patent No.:** **US D940,942 S**
(45) **Date of Patent:** **** Jan. 11, 2022**

- (54) **SENSOR LIGHT**
- (71) Applicant: **Shuang Zou**, Suizhou (CN)
- (72) Inventor: **Shuang Zou**, Suizhou (CN)
- (**) Term: **15 Years**
- (21) Appl. No.: **29/773,890**
- (22) Filed: **Mar. 12, 2021**
- (51) **LOC (13) Cl.** **26-05**
- (52) **U.S. Cl.**
USPC **D26/72; D26/85**
- (58) **Field of Classification Search**
USPC D26/72, 76, 78, 80, 85, 89
CPC F21S 8/03; F21S 8/031; F21S 8/033; F21S
8/038; F21S 8/04; F21S 8/046
See application file for complete search history.

D906,569 S 12/2020 Wu
D928,384 S * 8/2021 Zeng D26/89
D930,217 S * 9/2021 Johnson D26/85

OTHER PUBLICATIONS

Multi-Purpose Motion Sensor Light by Ledergo, Asin: B09G986J8N available from amazon.com Sep. 26, 2021. (Year: 2021).*
Under Cabinet Light by Calion Ltd, Asin: B07Y564TJ5 available from amazon.com Sep. 20, 2019. (Year: 2019).*
LED Closet Light by Vicbuy, Asin: B09G6S7HT3 available from amazon.com Sep. 14, 2021. (Year: 2021).*

* cited by examiner

Primary Examiner — Clare E Heflin

(57) **CLAIM**

The ornamental design for a sensor light, as shown and described.

DESCRIPTION

FIG. 1 is a perspective view of a sensor light showing my new design;
FIG. 2 is another perspective view thereof;
FIG. 3 is a front elevational view thereof;
FIG. 4 is a rear elevational view thereof;
FIG. 5 is a left side elevational view thereof;
FIG. 6 is a right side elevational view thereof;
FIG. 7 is a top plan view thereof; and,
FIG. 8 is a bottom plan view thereof.
The broken lines in the drawings depict portions of the sensor light that form no part of the claimed design.

1 Claim, 8 Drawing Sheets

- (56) **References Cited**
U.S. PATENT DOCUMENTS
- | | | | | |
|----------------|---------|-----------|-------|----------------------------|
| D344,605 S * | 2/1994 | Aspenwall | | D26/76 |
| D446,877 S * | 8/2001 | Lester | | D26/72 |
| D520,667 S * | 5/2006 | Jae-Sung | | D26/25 |
| D524,456 S | 7/2006 | Yuen | | |
| 8,388,171 B2 * | 3/2013 | Tung | | F21V 19/0045
362/217.01 |
| D690,870 S * | 10/2013 | Ng | | D26/80 |
| D799,733 S * | 10/2017 | Recker | | D26/76 |
| D831,257 S * | 10/2018 | Boulanger | | D26/76 |
| D851,805 S * | 6/2019 | Chen | | D26/76 |
| D888,314 S * | 6/2020 | Mangold | | D26/76 |

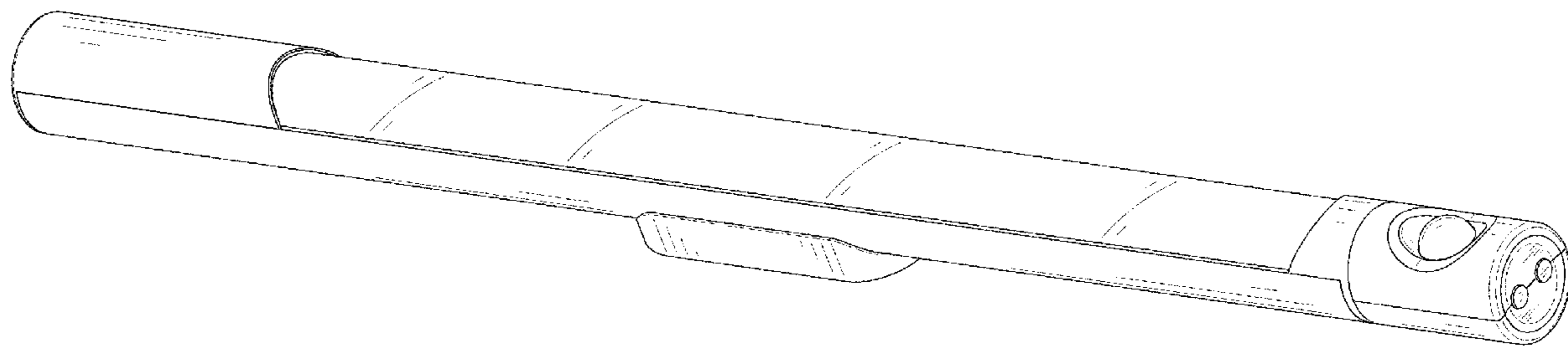

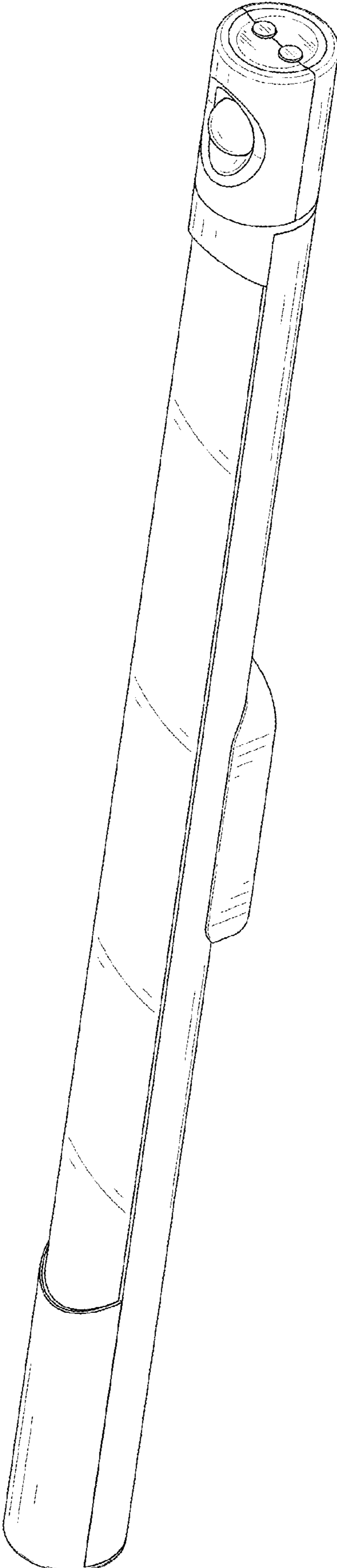

FIG. 1

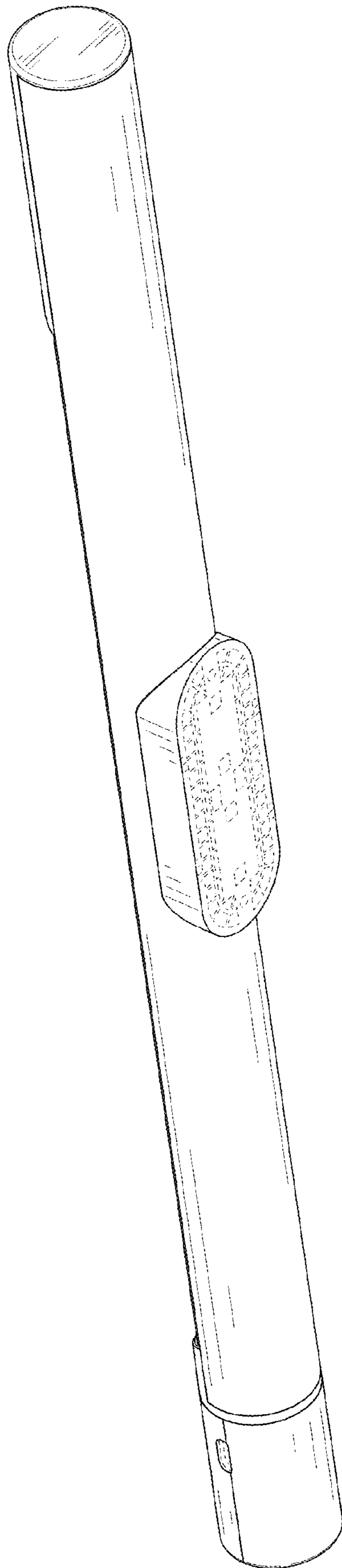

FIG. 2

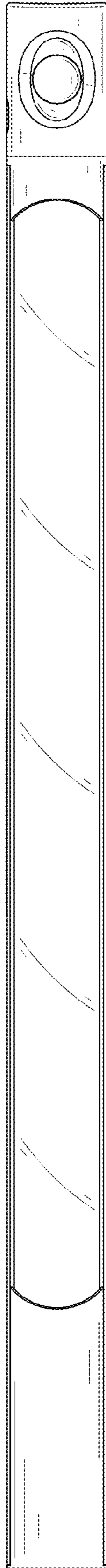

FIG. 3



FIG. 4

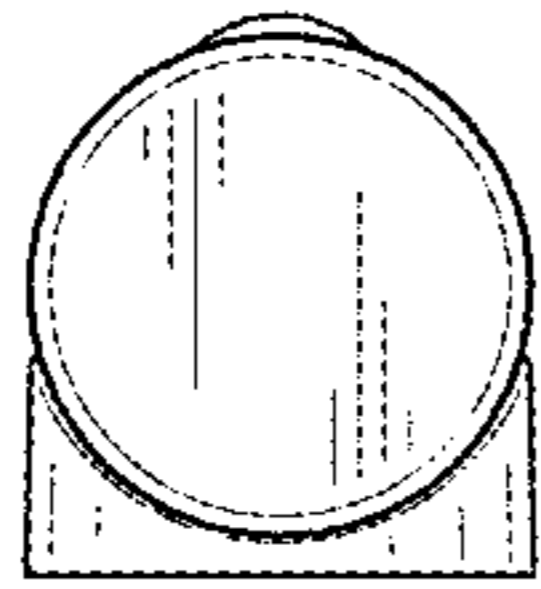

FIG. 5

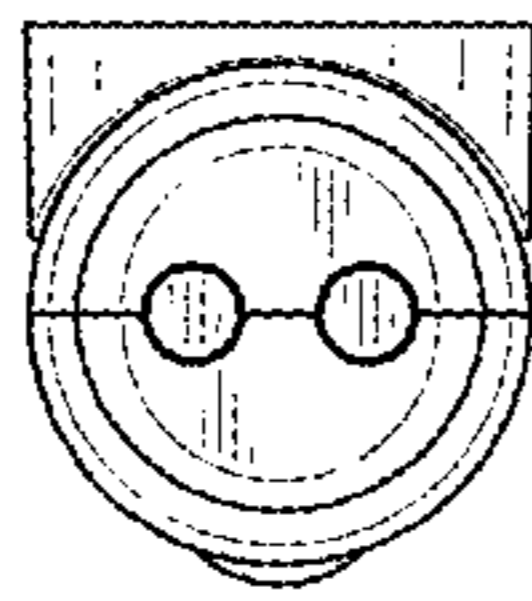

FIG. 6

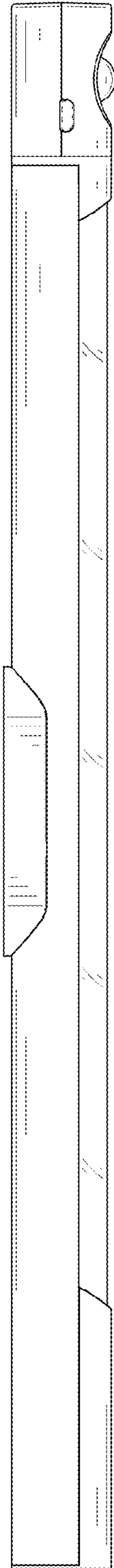

FIG. 7

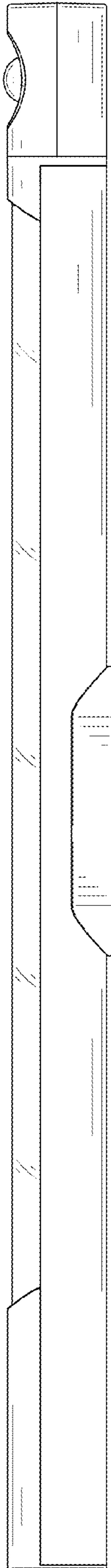

FIG. 8