

US00D940890S

(12) **United States Design Patent**
Cartledge et al.

(10) **Patent No.:** **US D940,890 S**
(45) **Date of Patent:** **** Jan. 11, 2022**

(54) **PORTABLE ELECTRONIC DEVICE**

(71) Applicants: **Richard Cartledge**, West Palm Beach, FL (US); **Ami Brannon**, West Palm Beach, FL (US); **Kermit Falk**, West Palm Beach, FL (US); **Peter Kratsch**, West Palm Beach, FL (US); **Vincent Manopoli**, West Palm Beach, FL (US)

(72) Inventors: **Richard Cartledge**, West Palm Beach, FL (US); **Ami Brannon**, West Palm Beach, FL (US); **Kermit Falk**, West Palm Beach, FL (US); **Peter Kratsch**, West Palm Beach, FL (US); **Vincent Manopoli**, West Palm Beach, FL (US)

(73) Assignee: **NEUVANA, LLC**, West Palm Beach, FL (US)

(**) Term: **15 Years**

(21) Appl. No.: **29/712,181**

(22) Filed: **Nov. 6, 2019**

(51) **LOC (13) Cl.** **28-03**

(52) **U.S. Cl.**
USPC **D24/200**

(58) **Field of Classification Search**
USPC D24/107, 170, 185-188, 200; D13/168; D14/388, 217, 218, 205, 223, 356, 358, D14/203.1, 203.6; D21/333
CPC A61N 1/00; A61N 1/02; A61N 1/0456; A61N 1/3603; A61N 1/36036; A61N 1/36038; A61N 1/18; A61N 1/32; A61N 1/36128; A61N 7/00; A61N 2007/0021; A61N 2007/0026

See application file for complete search history.

(56) **References Cited**

U.S. PATENT DOCUMENTS

3,236,240 A * 2/1966 Bradley A61N 1/36007
607/40
D273,952 S * 5/1984 Stansbury, Jr. D10/104.1

D303,430 S * 9/1989 Studer, Jr. D24/200
D308,521 S * 6/1990 Lonczak D14/230
D324,106 S * 2/1992 Greenblatt D24/200
D325,582 S * 4/1992 Emmons D14/218
D337,642 S * 7/1993 Yamasaki D24/200
D368,721 S * 4/1996 Howell D14/218
D375,909 S * 11/1996 Dziersk D10/106.1
D378,578 S * 3/1997 Eberhardt D10/104.1
D391,943 S * 3/1998 Han D14/356

(Continued)

FOREIGN PATENT DOCUMENTS

KR 2017057031 A * 5/2017 A61H 23/02

OTHER PUBLICATIONS

Neuvana Xen Review Vagus Nerve Stimulation Earbuds, (online) 11 pgs. Posted Jan. 31, 2020. [Retrieved Aug. 6, 2021] <https://www.gadgetexplained.com/2020/01/neuvana-xen-review-vagus-nerve.html>.*

Primary Examiner — Marie D. Fast Horse

(74) *Attorney, Agent, or Firm* — Lott & Fischer, P.L.

(57) **CLAIM**

The ornamental design for a portable electronic device, substantially as shown and described.

DESCRIPTION

FIG. 1 is a front perspective view of our new design; FIG. 2 is a front elevational view of the design of FIG. 1; FIG. 3 is a rear elevational view of the design of FIG. 1; FIG. 4 is a top view of the design of FIG. 1; FIG. 5 is a bottom view of the design of FIG. 1; FIG. 6 is a left side elevational view of the design of FIG. 1; and, FIG. 7 is a right side elevational view of the design of FIG. 1.

The broken lines in the figures depict portions of the portable electronic device that are shown for reference and form no part of the claimed design.

1 Claim, 5 Drawing Sheets

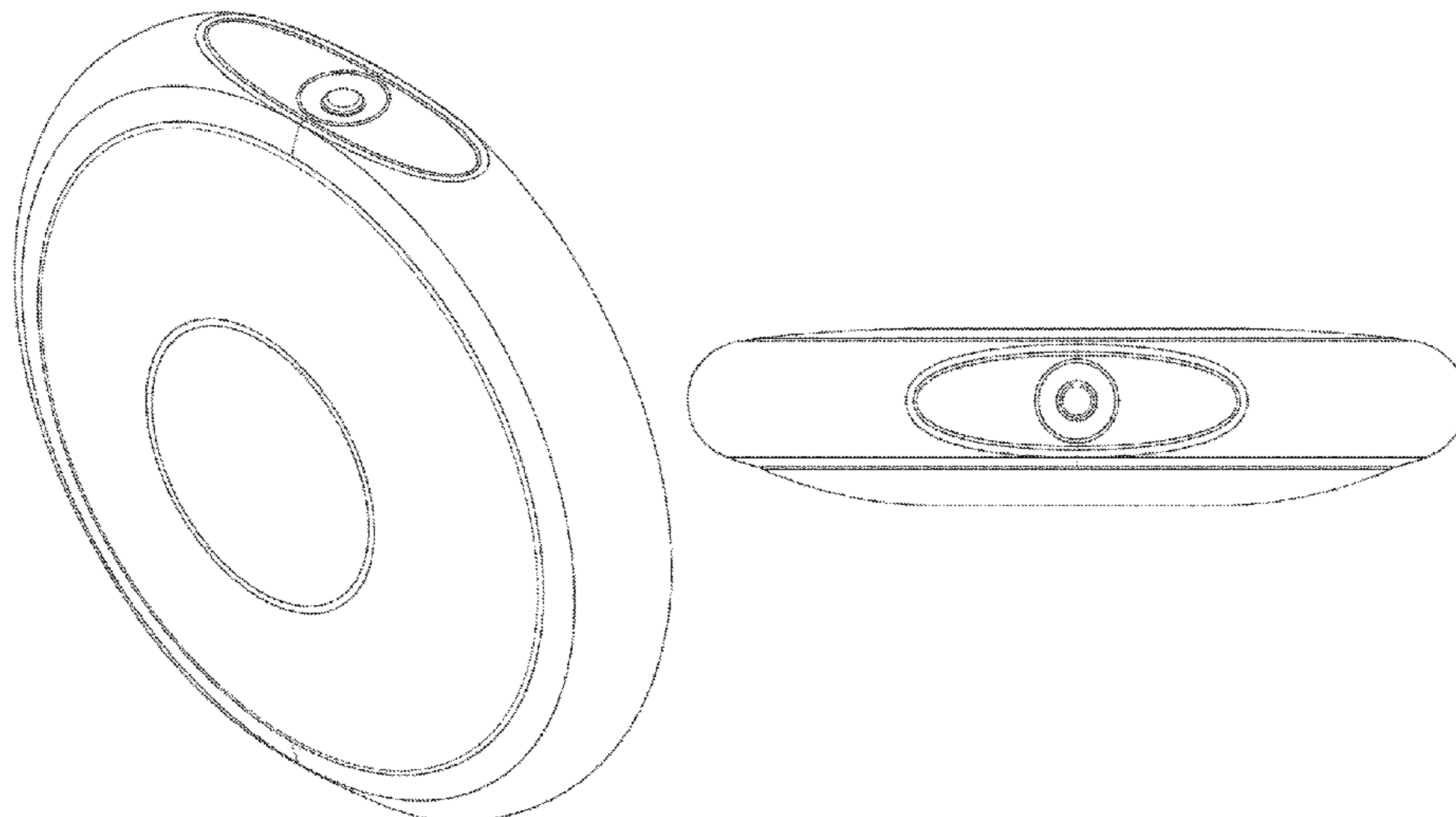

(56)

References Cited

U.S. PATENT DOCUMENTS

D418,837	S	*	1/2000	Ishii	D14/218
D427,993	S	*	7/2000	Seal	D14/218
D430,143	S	*	8/2000	Renk	D14/218
D431,240	S	*	9/2000	Deguchi	D13/168
D435,543	S	*	12/2000	Nakamura	D14/217
D442,570	S	*	5/2001	Arjomand	D14/160
D448,365	S	*	9/2001	Kerestegian	D14/240
D458,249	S	*	6/2002	Hayashi	D14/218
6,445,955	B1	*	9/2002	Michelson	A61N 1/0456 607/46
D463,991	S	*	10/2002	Curry	D10/104.1
D494,633	S	*	8/2004	Nussberger	D21/324
D496,668	S	*	9/2004	Huang	D14/203.6
D512,437	S	*	12/2005	Tierney	D14/203.6
D514,095	S	*	1/2006	Wilson	D14/223
D516,082	S	*	2/2006	Lewis	D14/203.6
D518,030	S	*	3/2006	Lin	D14/218
D521,022	S	*	5/2006	Chen	D14/203.6
D524,295	S	*	7/2006	Jacobson	D14/218
D532,778	S	*	11/2006	Hussaini	D14/218
D538,821	S	*	3/2007	Bender	D14/203.6
D539,304	S	*	3/2007	Lee	D14/203.6
D542,234	S	*	5/2007	Shimizu	D13/168
D542,280	S	*	5/2007	Taylor	D14/218
D579,572	S	*	10/2008	Wittenbrock	D24/209
D594,127	S	*	6/2009	Causevic	D24/187
D594,851	S	*	6/2009	Dai	D14/218
D596,622	S	*	7/2009	Lee	D14/218
D597,211	S	*	7/2009	Ewing	D24/187
D598,008	S	*	8/2009	Shimizu	D13/168
D600,673	S	*	9/2009	Kim	D14/205
D601,564	S	*	10/2009	Maeno	D14/400
D602,915	S	*	10/2009	Song	D14/218
D607,347	S	*	1/2010	Goh	D10/46
D618,667	S	*	6/2010	Chiu	D14/218
D627,306	S	*	11/2010	Charleux	D13/168
D627,476	S	*	11/2010	Gaw	D24/186
D636,380	S	*	4/2011	Valeur	D14/218
D637,306	S	*	5/2011	Feuerabend	D24/215
D643,412	S	*	8/2011	Brady	D14/218
RE42,686	E	*	9/2011	Shimizu	D13/168
D664,932	S	*	8/2012	Sedic	D13/168
D666,175	S	*	8/2012	Yamada	D14/218
D666,176	S	*	8/2012	Yamada	D14/218
D700,904	S	*	3/2014	Miller	D14/218
D701,610	S	*	3/2014	Thomas	D24/200
D704,848	S	*	5/2014	Thomas	D24/200
D712,052	S	*	8/2014	Thomas	D24/200
D732,033	S	*	6/2015	Sakaguchi	D14/388
D732,672	S	*	6/2015	Lewis, Jr.	D24/187
D735,873	S	*	8/2015	Brefka	D24/200
D738,376	S	*	9/2015	Sakaguchi	D14/388
D738,858	S	*	9/2015	Tuhkanen	D14/218
D742,355	S	*	11/2015	Toelle	D14/205
D743,381	S	*	11/2015	Pi	D14/218
D756,333	S	*	5/2016	Smith	D14/218
D757,275	S	*	5/2016	Lee	D24/187
D757,691	S	*	5/2016	Smith	D14/218
D759,257	S	*	6/2016	Chen	D24/200
D768,114	S	*	10/2016	Hou	D14/218
D776,285	S	*	1/2017	Dinger	D24/186
D783,838	S	*	4/2017	Zhao	D24/186
D786,200	S	*	5/2017	Lagerstedt	D13/168
D791,741	S	*	7/2017	Chen	D14/223
D796,355	S	*	9/2017	Cho	D10/70
D796,682	S	*	9/2017	Falk	D24/186
D802,589	S	*	11/2017	Fisher	D14/358
D802,779	S	*	11/2017	Inoue	D24/200
D804,674	S	*	12/2017	Im	D24/186
D805,209	S	*	12/2017	Moon	D24/200
D806,254	S	*	12/2017	Im	D24/186
D810,311	S	*	2/2018	Chen	D24/200
D810,952	S	*	2/2018	Hsu	D24/200
D812,577	S	*	3/2018	Turksu	D13/168
D812,765	S	*	3/2018	Vardiman	D24/200
D816,051	S	*	4/2018	Robbins	D14/137
D824,034	S	*	7/2018	Pushpala	D24/186
D831,189	S	*	10/2018	Fang	D24/107
D834,719	S	*	11/2018	Theriot	D24/200
D836,568	S	*	12/2018	Miller	D13/168
D838,372	S	*	1/2019	Goering	D24/186
D839,189	S	*	1/2019	Miller	D13/108
D840,361	S	*	2/2019	Gassner	D13/168
D844,796	S	*	4/2019	Wise	D24/211
D855,193	S	*	7/2019	Levi	D24/200
D861,904	S	*	10/2019	Ho	D24/200
D863,256	S	*	10/2019	Lindof	D14/217
D863,258	S	*	10/2019	Song	D14/218
D863,572	S	*	10/2019	Thomas	D24/200
D865,760	S	*	11/2019	Beristain	D14/344
D868,603	S	*	12/2019	Yin	D10/53
D870,896	S	*	12/2019	Komaki	D24/186
D875,691	S	*	2/2020	Zu	D13/168
D876,247	S	*	2/2020	Hernandez	D10/52
D876,248	S	*	2/2020	Hernandez	D10/52
D876,371	S	*	2/2020	Lee	D13/168
D879,053	S	*	3/2020	Yu	D13/168
D881,040	S	*	4/2020	Hernandez	D10/52
D904,981	S	*	12/2020	Worthy	D13/110
D928,150	S	*	8/2021	Maruyama	D24/186
D929,990	S	*	9/2021	Maruyama	D24/186
2005/0187497	A1	*	8/2005	Nguyen	A61N 1/32 601/21
2015/0112404	A1	*	4/2015	Holding	A61N 1/0456 607/46
2015/0148864	A1	*	5/2015	Peterson	A61N 1/36067 607/45
2015/0174402	A1	*	6/2015	Thomas	A61N 1/36021 607/46
2015/0306387	A1	*	10/2015	Kong	A61N 1/0456 607/62
2017/0209693	A1	*	7/2017	An	A61N 1/0456
2019/0134388	A1	*	5/2019	Thomas	A61N 1/0456

* cited by examiner

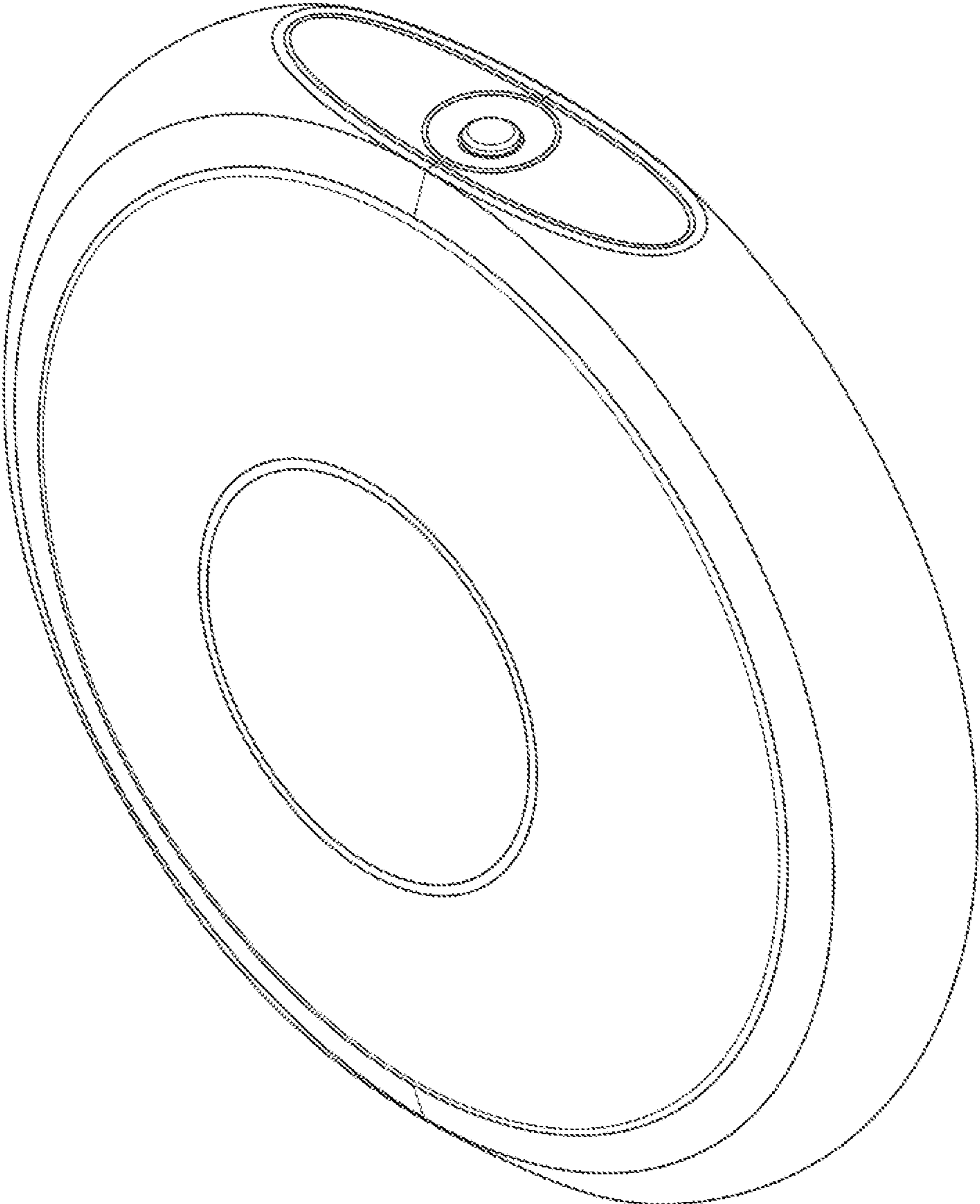

FIG. 1

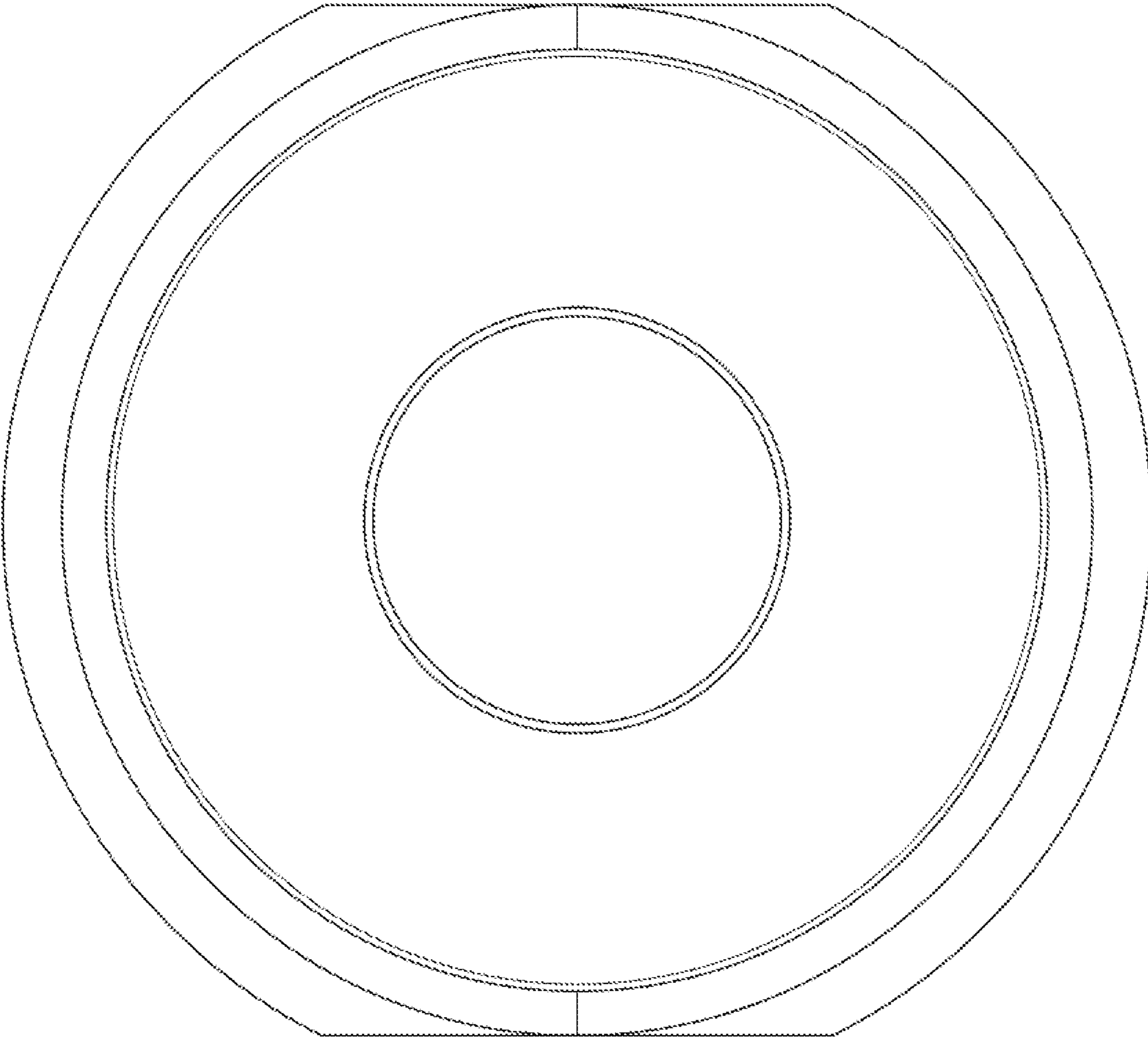

FIG. 2

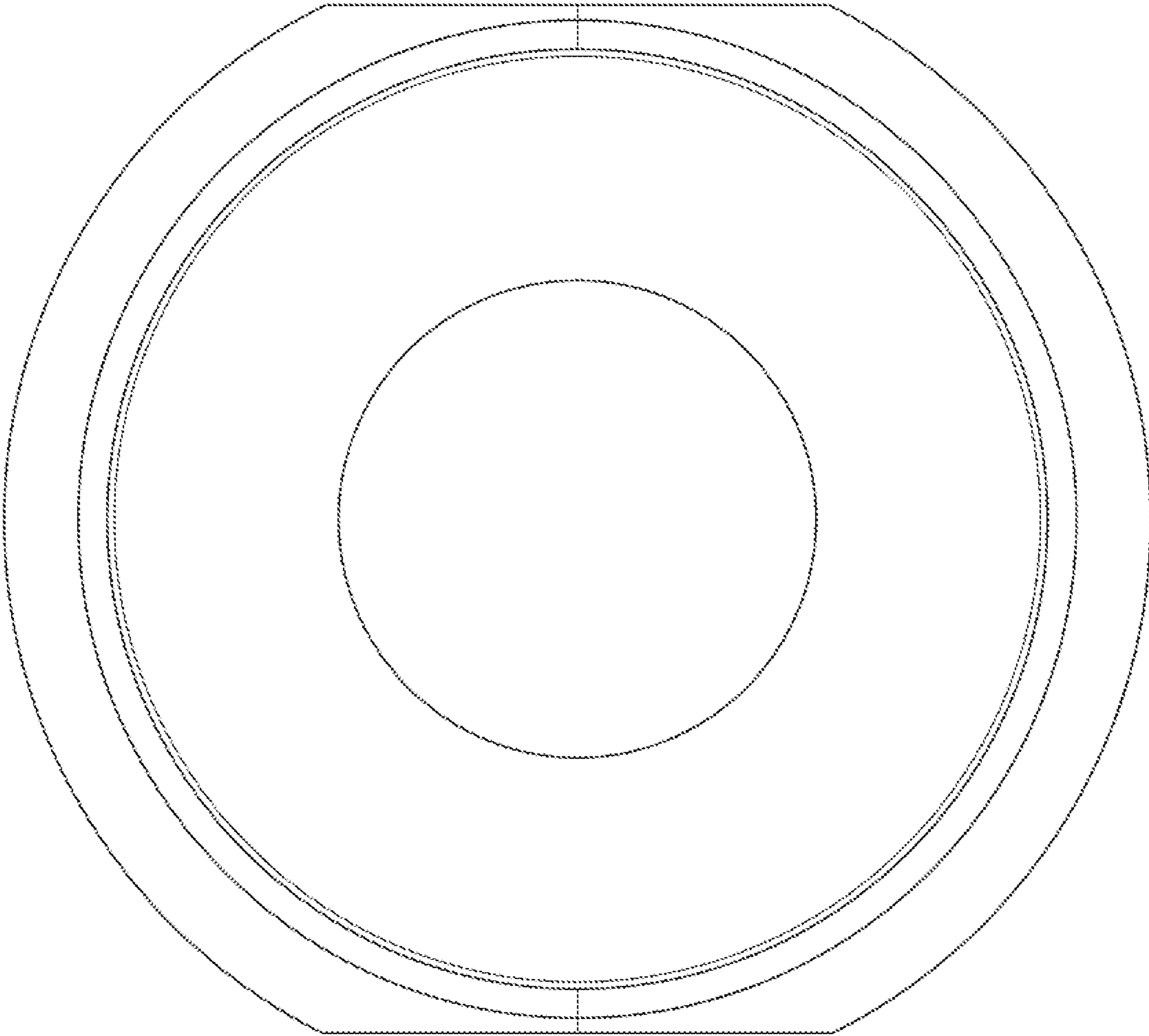

FIG. 3

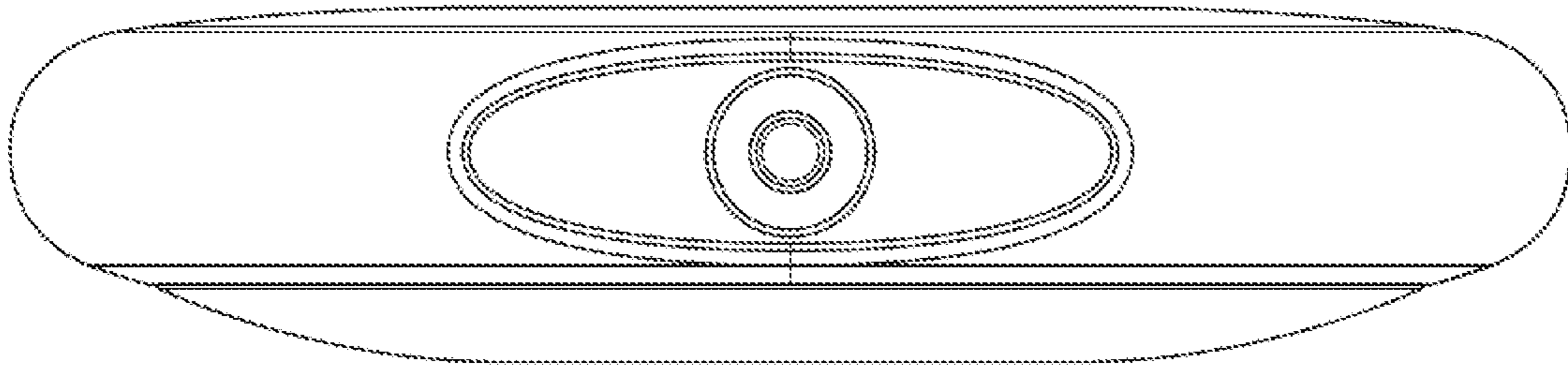

FIG. 4

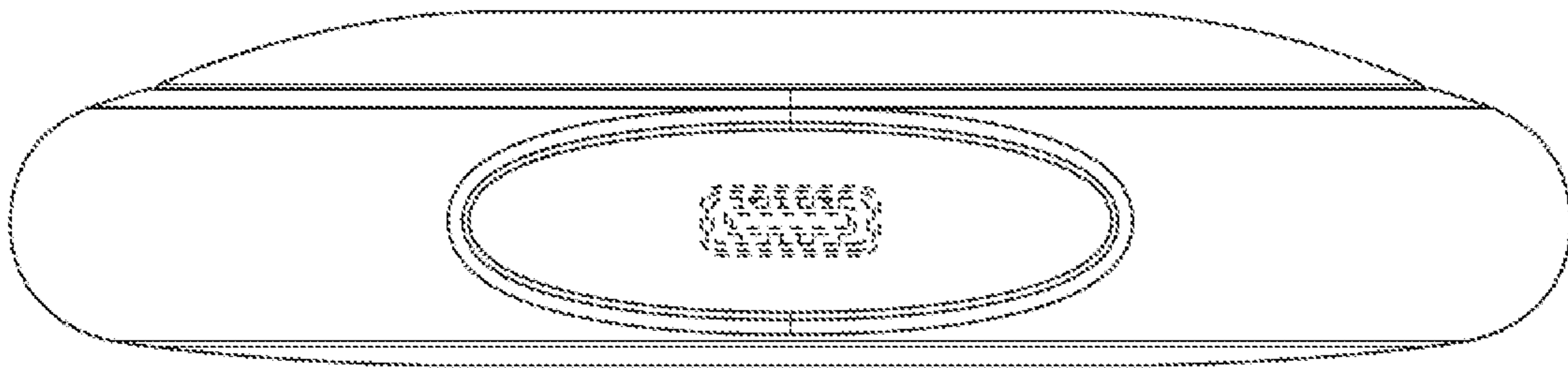

FIG. 5

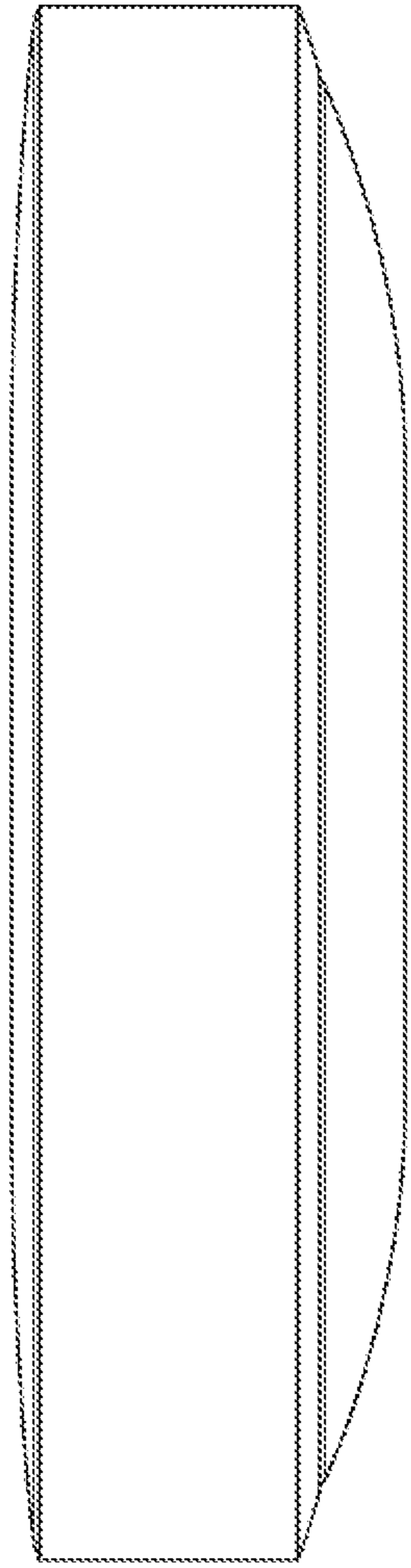

FIG. 6

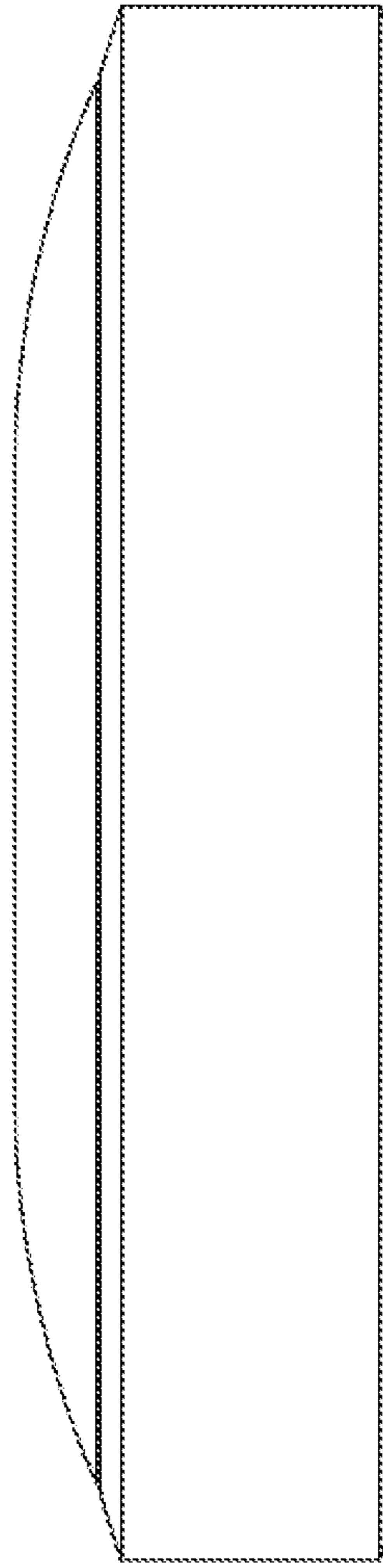

FIG. 7