



US00D940889S

(12) **United States Design Patent**
Hocking

(10) **Patent No.:** **US D940,889 S**
(45) **Date of Patent:** **** Jan. 11, 2022**

- (54) **HANDHELD MEDICAL DEVICE**
- (71) Applicant: **Center for Pain and Stress Research LTD, Toronto (CA)**
- (72) Inventor: **Bruce Hocking, Toronto (CA)**
- (73) Assignee: **Center for Pain and Stress Research LTD, Toronto (CA)**
- (**) Term: **15 Years**
- (21) Appl. No.: **29/607,659**
- (22) Filed: **Jun. 15, 2017**
- (51) **LOC (13) Cl.** **28-03**
- (52) **U.S. Cl.**
USPC **D24/200**
- (58) **Field of Classification Search**
USPC D24/107, 133, 188, 200, 206, 209,
D24/211–215, 221; D28/9, 13, 14, 44,
D28/51, 96, 97; 601/1, 5, 46, 48, 64, 80;
607/1, 95, 96, 99, 101, 103, 109, 115
CPC A61H 7/00; A61H 7/003; A61H 7/004;
A61H 7/005; A61H 7/006; A61H 15/00;
A61H 15/005; A61H 15/0014; A61H
2201/02; A61H 2201/0207; A61H
2201/0263; A61H 2201/0153; A61H
2205/00; A61H 2205/02; A61H 2205/04;
A61H 2205/06; A61H 2205/08; A61H
2205/022; A61H 2205/025; A61H
2205/084; A61H 2205/086
See application file for complete search history.

(56) **References Cited**

U.S. PATENT DOCUMENTS

- D402,083 S * 12/1998 Lee D28/44
- D530,680 S * 10/2006 Fox D13/168
- D585,987 S * 2/2009 Aparici D24/133
- D588,696 S * 3/2009 Mantle D24/144

- D598,543 S * 8/2009 Vogel D24/133
- D628,692 S * 12/2010 Greenhalgh D24/133
- D638,935 S * 5/2011 Gilmore, III D24/133
- D734,479 S * 7/2015 Youngquist D24/158
- D795,423 S * 8/2017 Chen D24/133
- D799,694 S * 10/2017 Mori D24/133
- D802,841 S * 11/2017 Kling D28/44.1
- D820,464 S * 6/2018 Gabriele D24/209
- 2006/0030908 A1* 2/2006 Powell A61N 5/0616
607/88
- 2008/0065056 A1* 3/2008 Powell A61N 5/0616
606/9
- 2011/0276113 A1* 11/2011 Cybulski A61B 18/042
607/101

(Continued)

Primary Examiner — Wan Laymon
Assistant Examiner — Clint A Samuel
(74) *Attorney, Agent, or Firm* — Clifford H. Kraft

(57) **CLAIM**

The ornamental design for a handheld medical device, as shown and described.

DESCRIPTION

FIG. 1 is a perspective view of the handheld medical device. FIG. 2 is a bottom view thereof. FIG. 3 is an expanded view of the two switches shown in FIG. 2 in their alternate position. FIG. 4 is a top view of the handheld medical device. FIG. 5 is a side view thereof; the left and right side views are mirror images of each other. FIG. 6 is a front view thereof; and, FIG. 7 a back view thereof. The long dash-short dash broken lines shown in the drawings depict portions of the handheld medical device that form no part of the claimed design. The short dash broken lines shown the functional switch wells and screw holes depict boundaries of the claim and form no part of the claimed design.

1 Claim, 5 Drawing Sheets

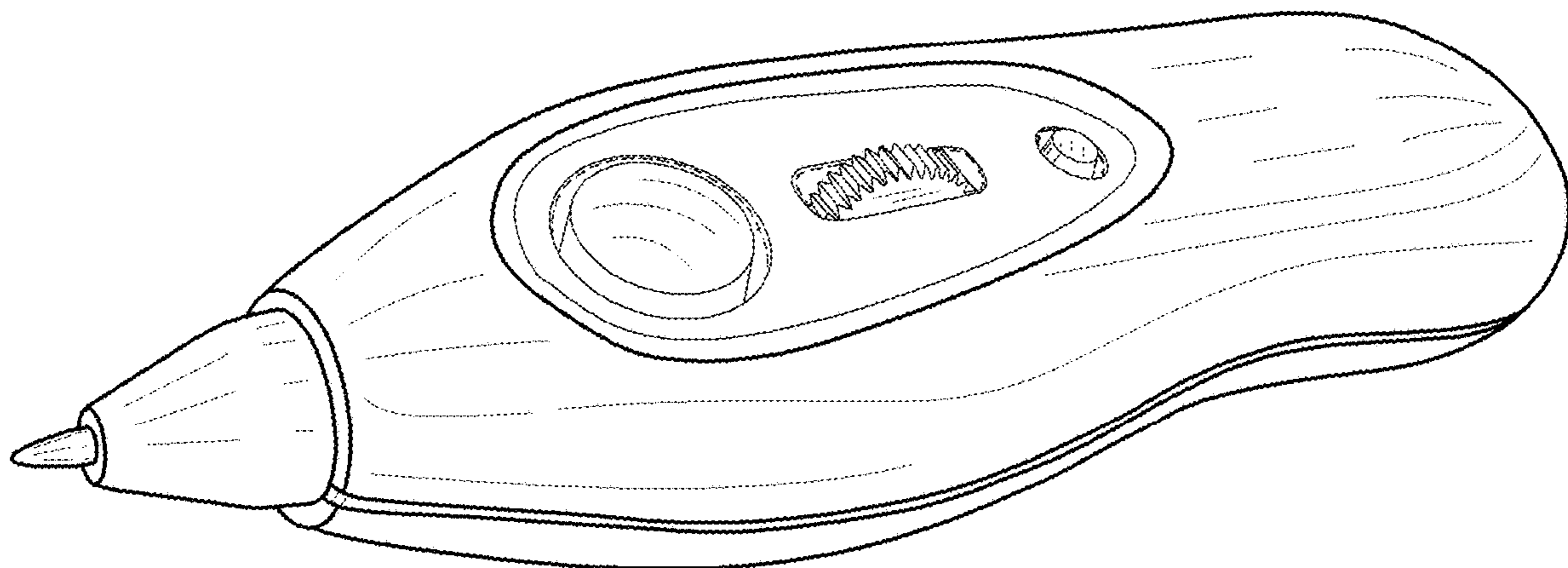

(56)

References Cited

U.S. PATENT DOCUMENTS

2016/0166429 A1* 6/2016 Allison A61B 18/02
604/506

* cited by examiner

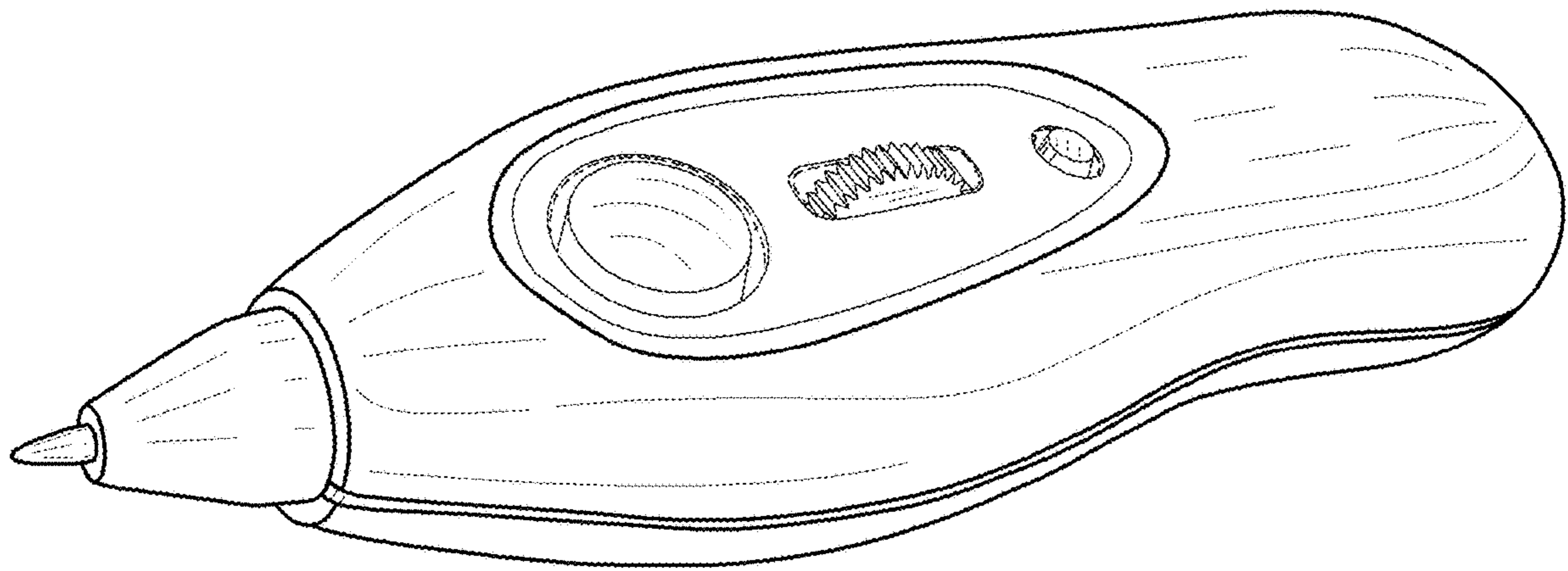

Fig. 1

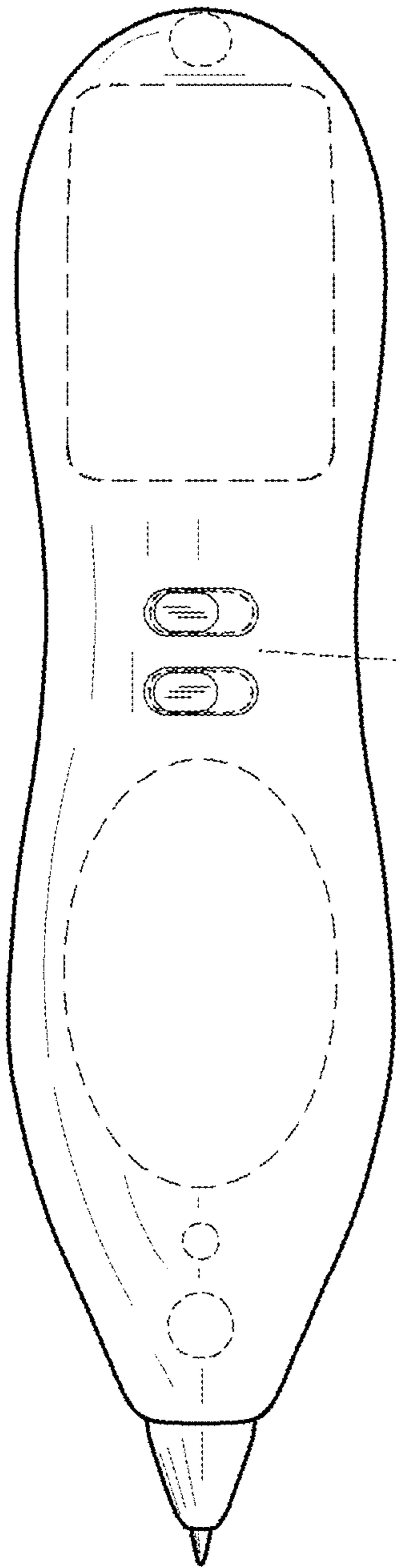

Fig. 2

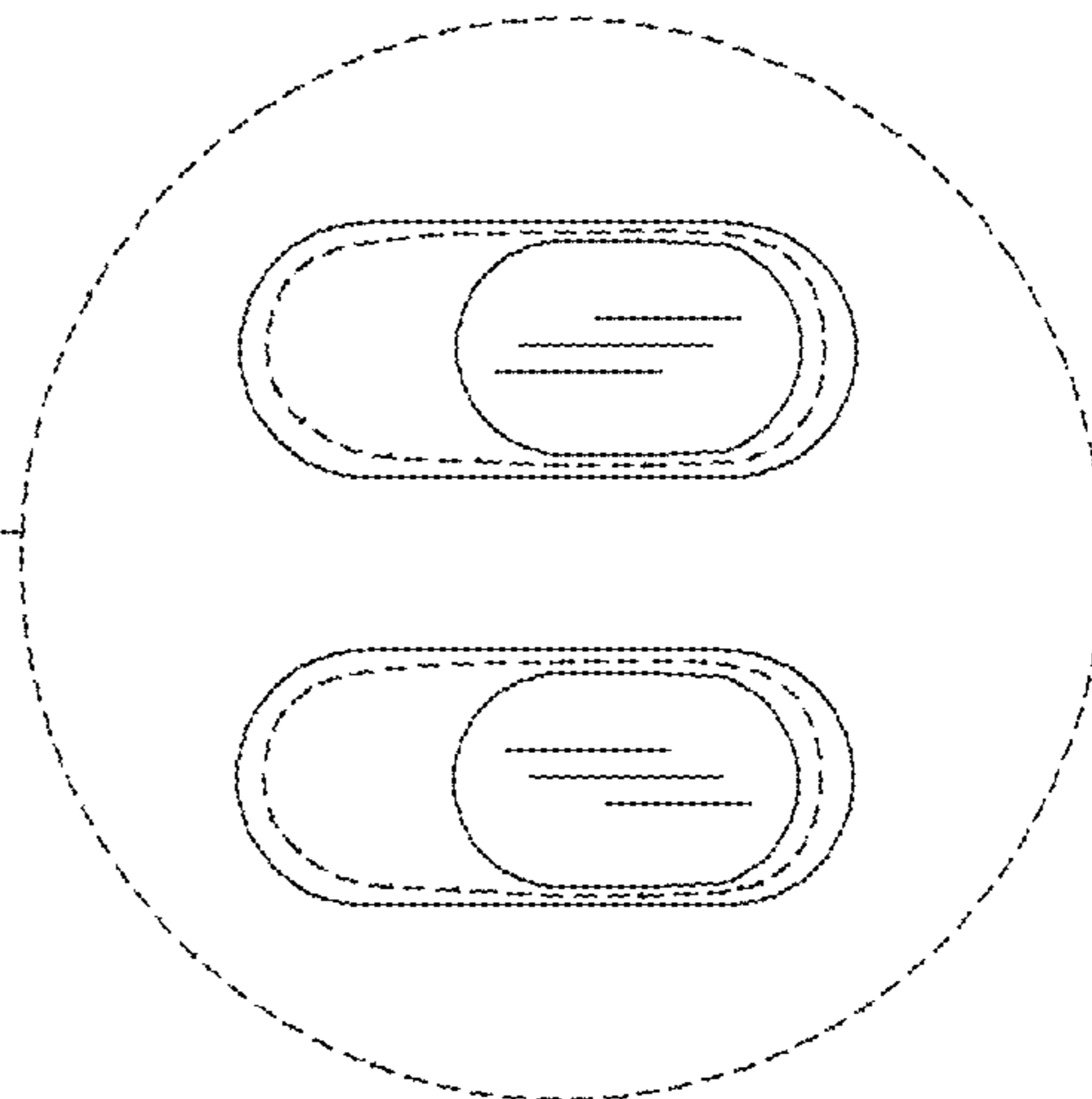

Fig. 3

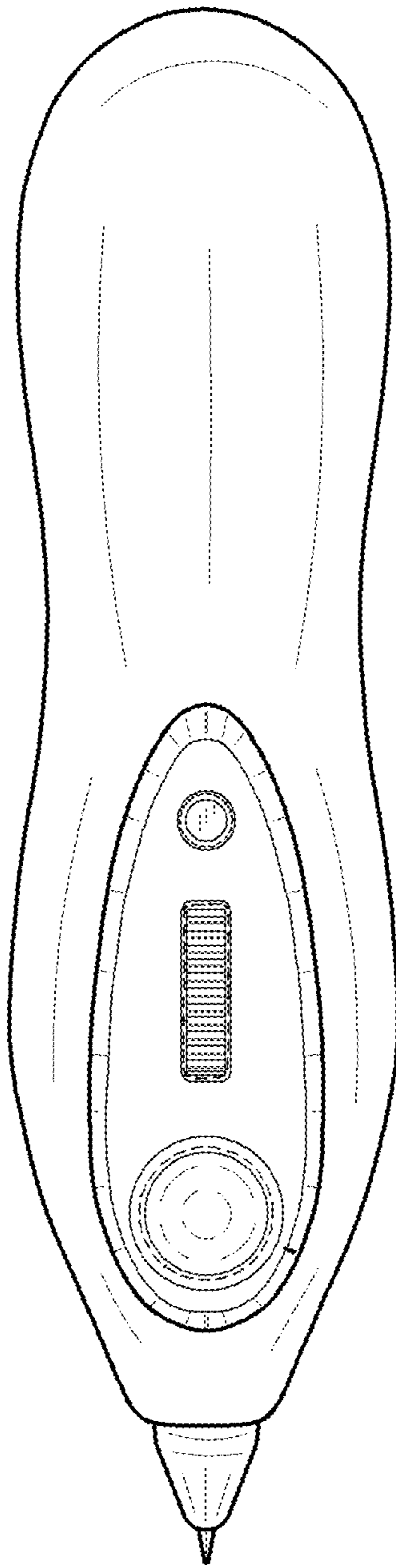

Fig. 4

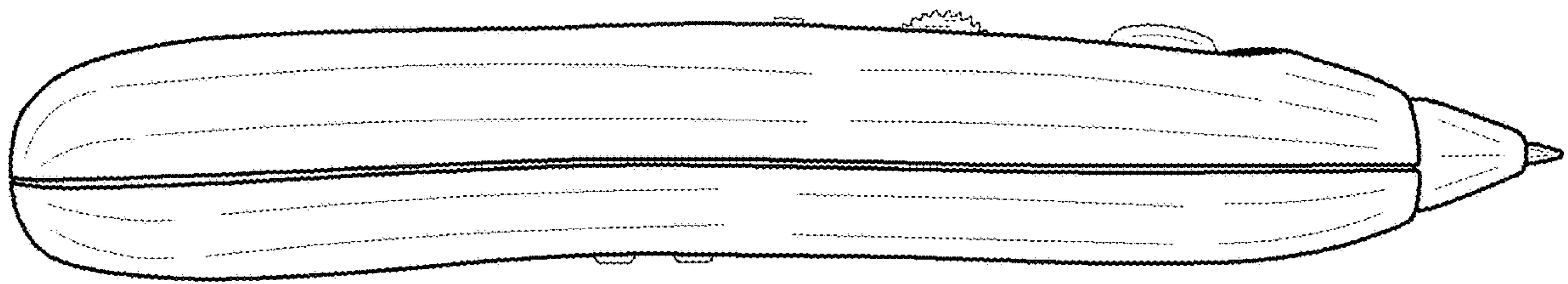

Fig. 5

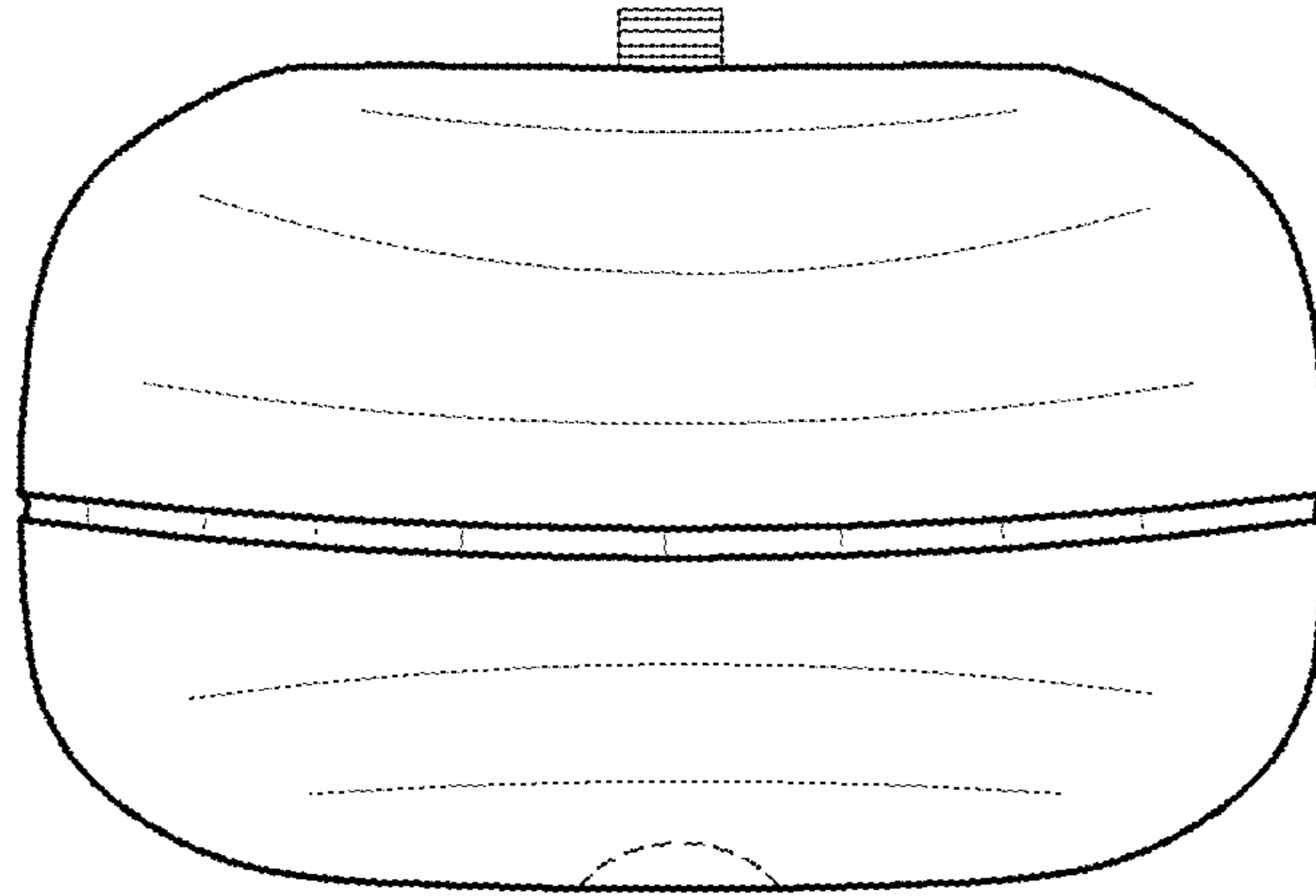

Fig. 7

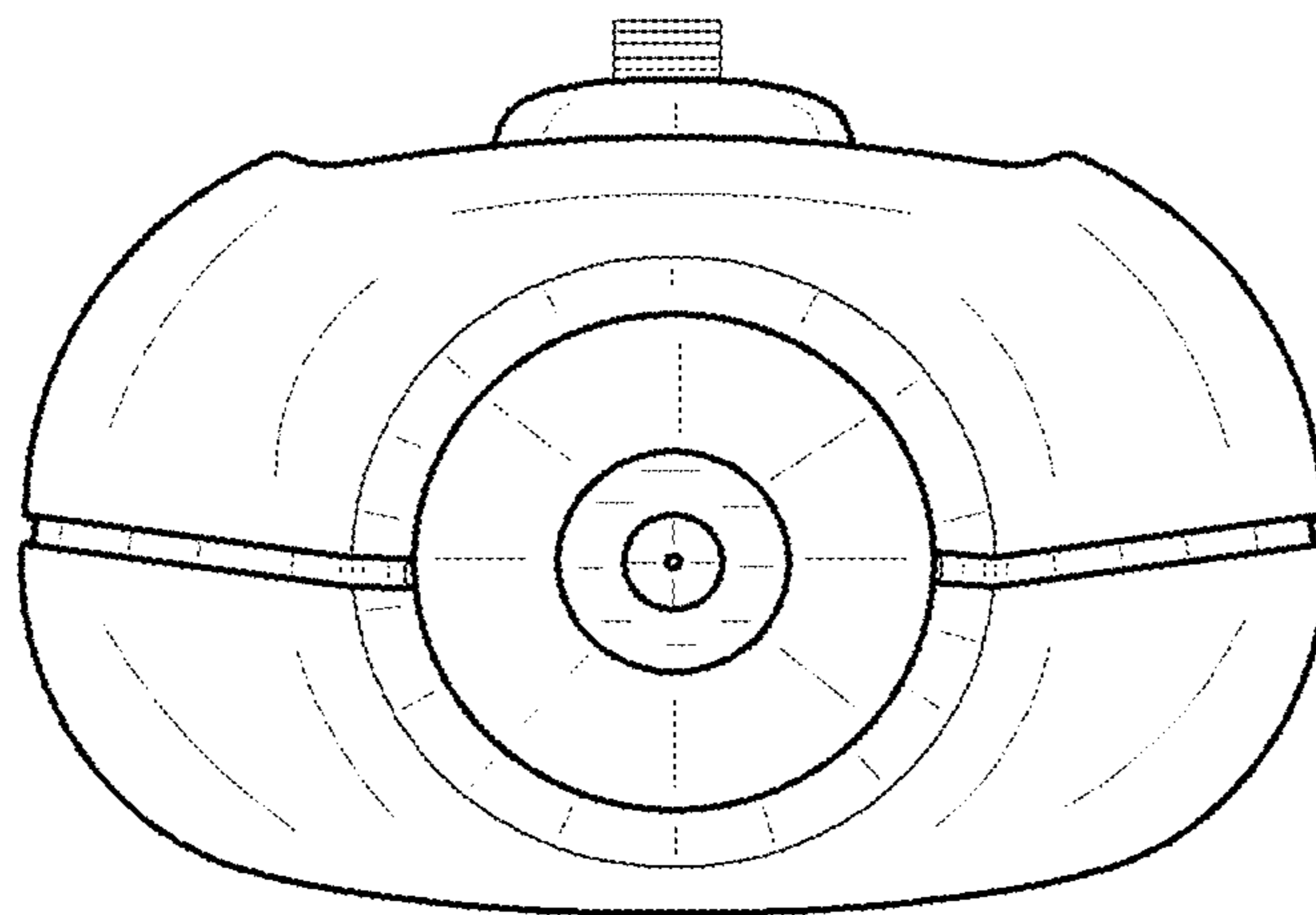

Fig. 6