



US00D940877S

(12) **United States Design Patent**
Zhang et al.

(10) **Patent No.:** **US D940,877 S**
(45) **Date of Patent:** **** Jan. 11, 2022**

- (54) **DENTAL BUCCAL TUBE**
- (71) Applicant: **GUANGZHOU OO MEDICAL SCIENTIFIC LIMITED**, Guangdong (CN)
- (72) Inventors: **Qinhui Zhang**, Guangdong (CN); **Zien Xu**, Guangdong (CN)
- (73) Assignee: **GUANGZHOU OO MEDICAL SCIENTIFIC LIMITED**, Guangzhou (CN)
- (**) Term: **15 Years**
- (21) Appl. No.: **29/732,920**
- (22) Filed: **Apr. 28, 2020**
- (30) **Foreign Application Priority Data**
Nov. 1, 2019 (CN) 201930599644.0
- (51) **LOC (13) Cl.** **24-02**
- (52) **U.S. Cl.**
USPC **D24/180**
- (58) **Field of Classification Search**
USPC D24/176–182
CPC .. A61C 7/12; A61C 7/14; A61C 7/141; A61C 7/16; A61C 7/143; A61C 7/28; A61C 7/282; A61C 7/285; A61C 7/34
See application file for complete search history.

D766,443 S * 9/2016 Takeda D24/180
 10,201,403 B2 * 2/2019 Ji A61C 7/34
 10,398,531 B2 * 9/2019 Ji A61C 7/14

FOREIGN PATENT DOCUMENTS

CN 306058681 * 11/2019
 CN 306058683 * 11/2019
 CN 305950473 * 3/2020

* cited by examiner

Primary Examiner — Wan Laymon

(74) *Attorney, Agent, or Firm* — Lathrop GPM LLP

(57) **CLAIM**

The ornamental design for a dental buccal tube, as shown and described.

DESCRIPTION

FIG. 1 is a front right perspective view of the dental buccal tube;
 FIG. 2 is a front view thereof;
 FIG. 3 is a rear view thereof;
 FIG. 4 is a left side view thereof;
 FIG. 5 is a right side view thereof;
 FIG. 6 is a top view thereof;
 FIG. 7 is a bottom view thereof;
 FIG. 8 is a front right perspective view thereof in the change state;
 FIG. 9 is a front view thereof in the change state;
 FIG. 10 is a rear view thereof in the change state;
 FIG. 11 is a left side view thereof in the change state;
 FIG. 12 is a right side view thereof in the change state;
 FIG. 13 is a top view thereof in the change state; and,
 FIG. 14 is a bottom view thereof in the change state.
 The dental buccal tube may be used for orthodontic treatment, while the concealable traction hook can be stored and unfolded according to the treatment needs.
 The broken line shown in the drawings is included for the purpose of illustrating portions of the dental buccal tube and forms no part of the claimed design.

1 Claim, 7 Drawing Sheets

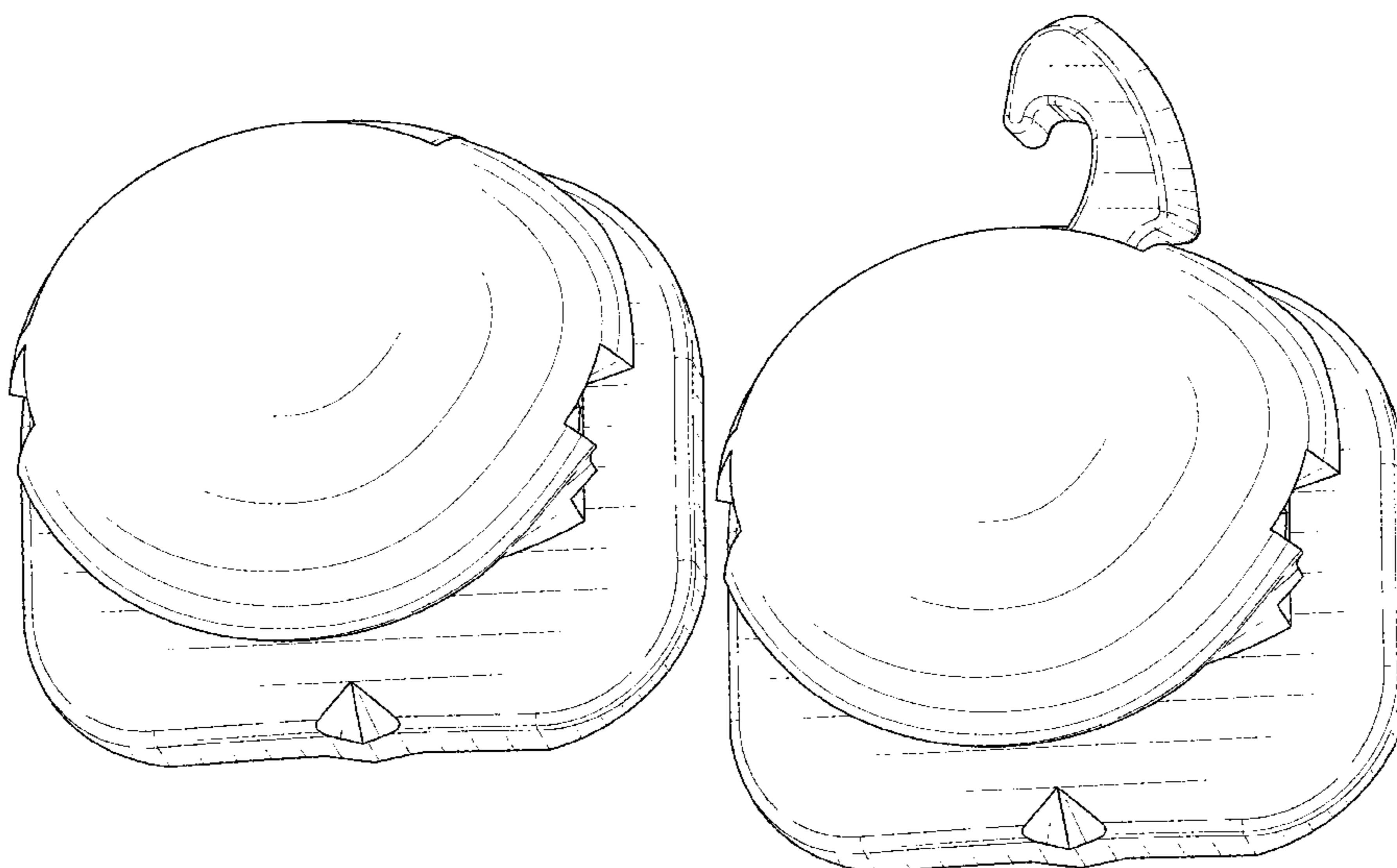

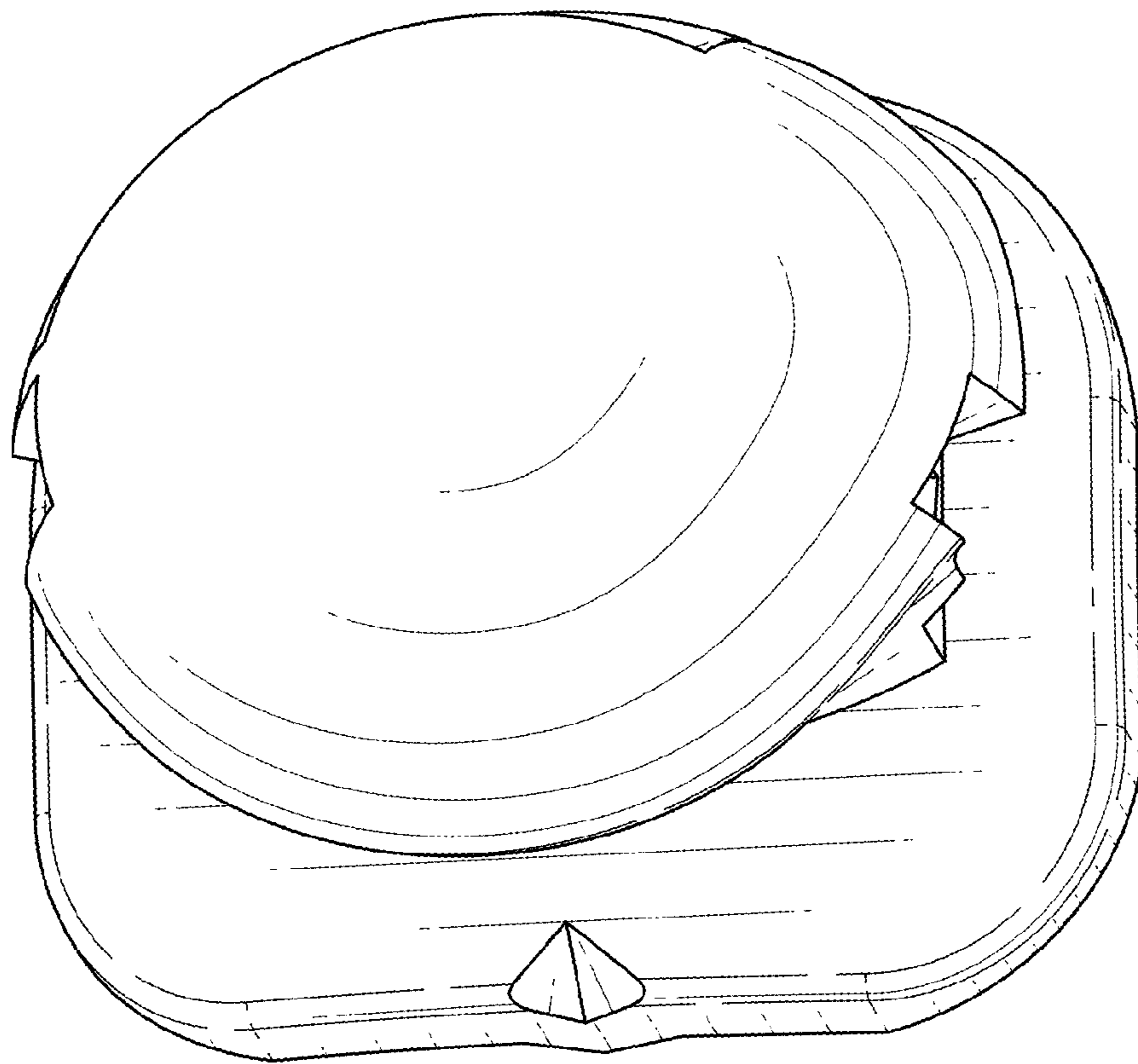

FIG. 1

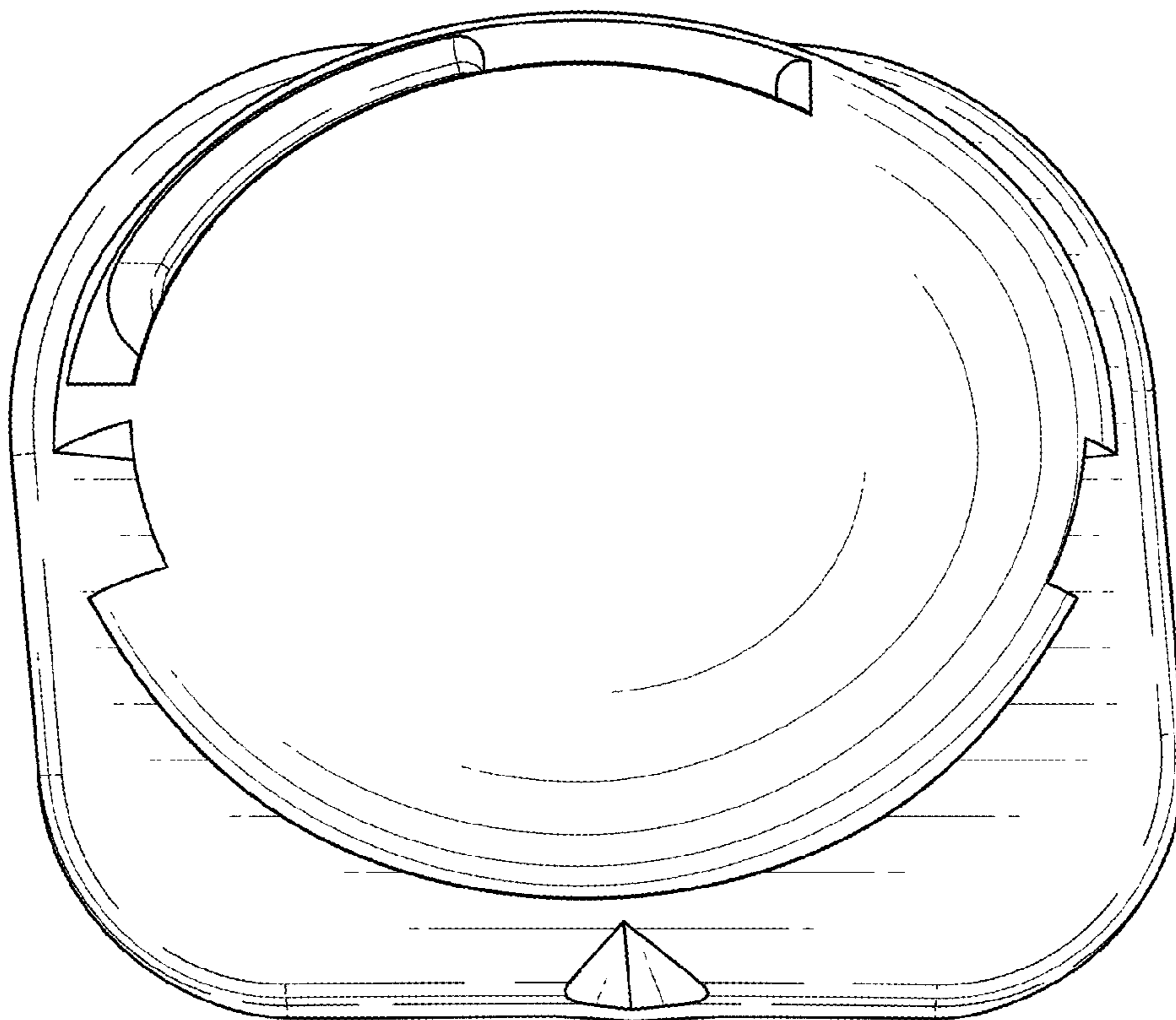

FIG. 2

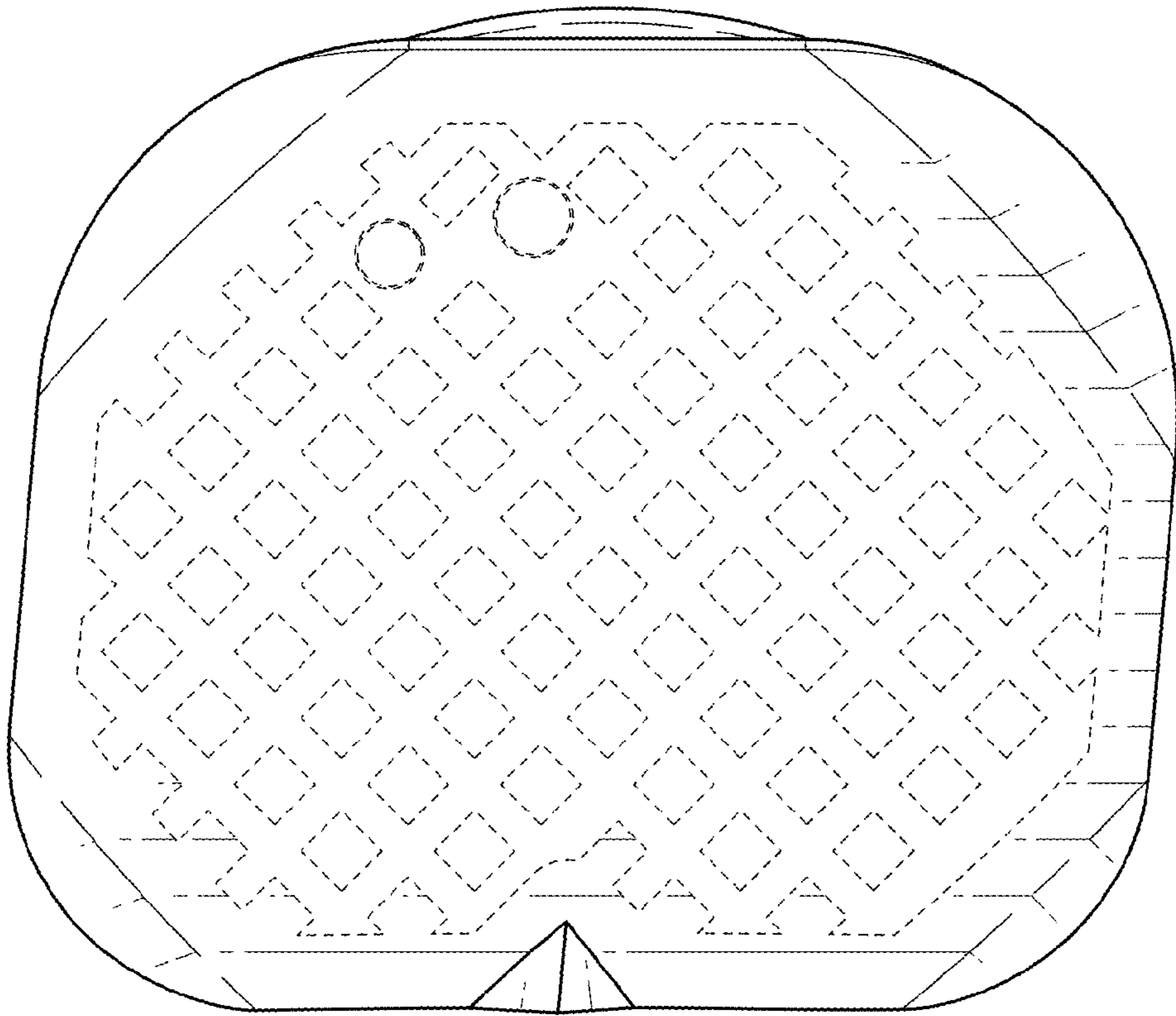

FIG. 3

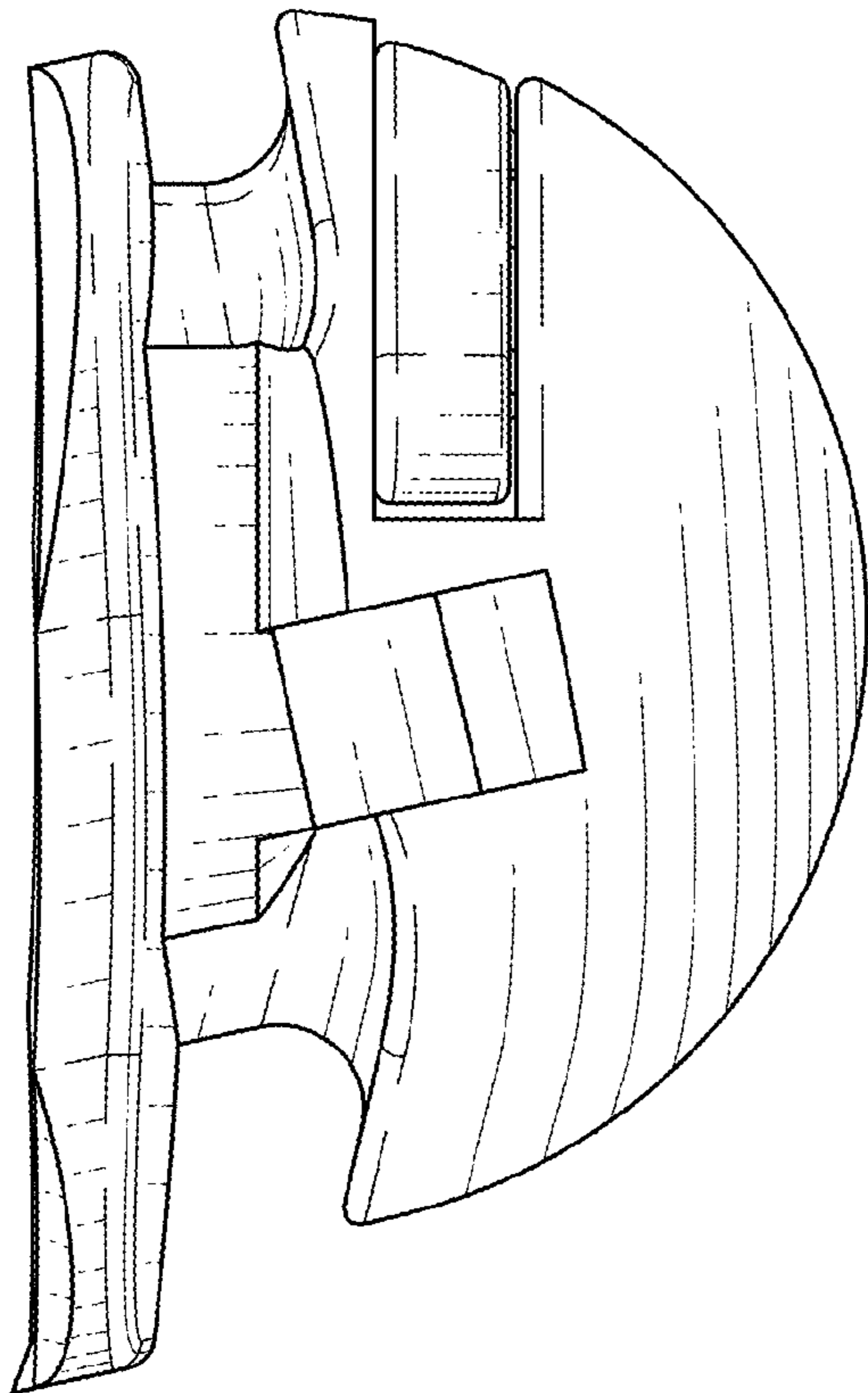

FIG. 4

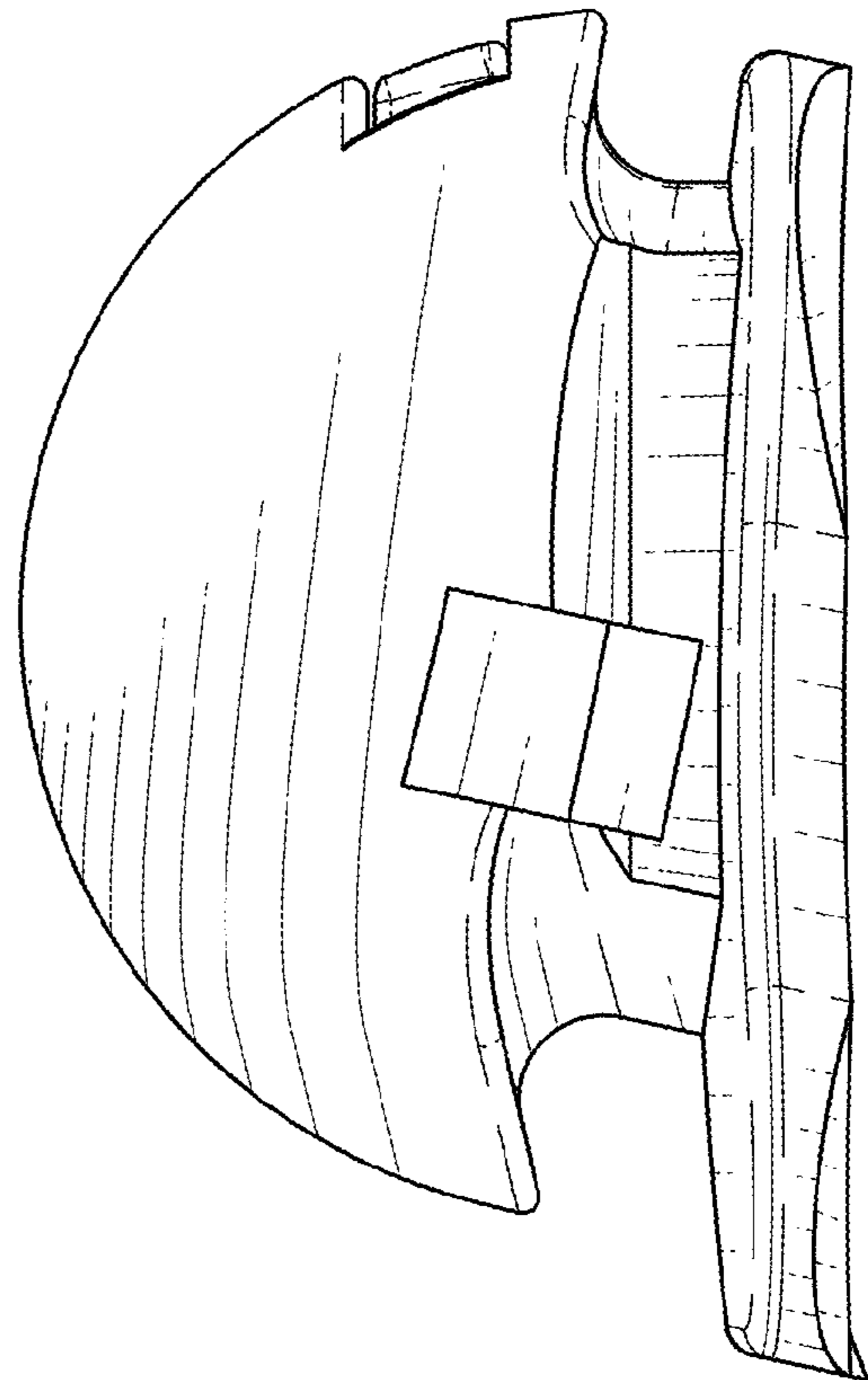

FIG. 5

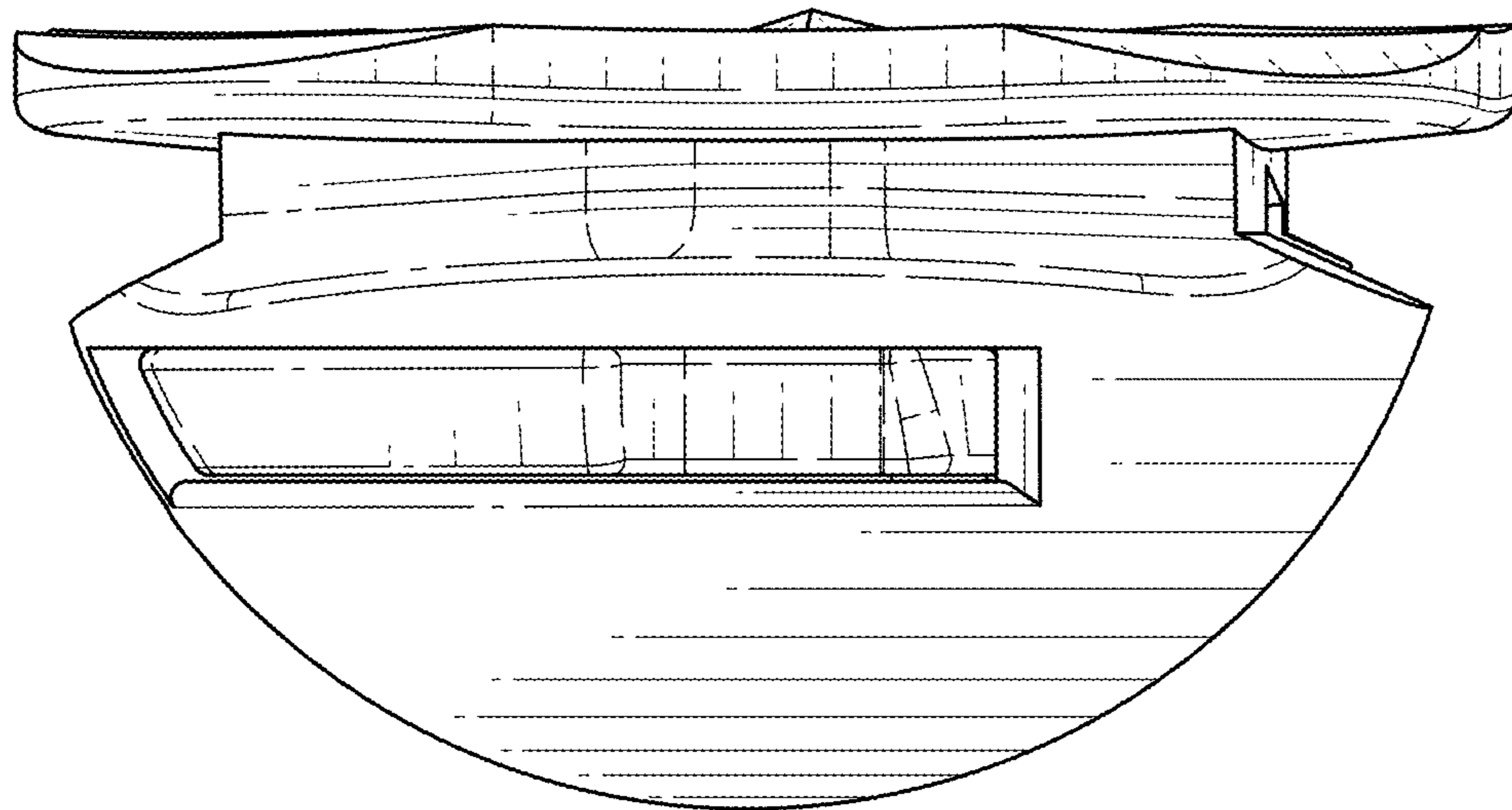

FIG. 6

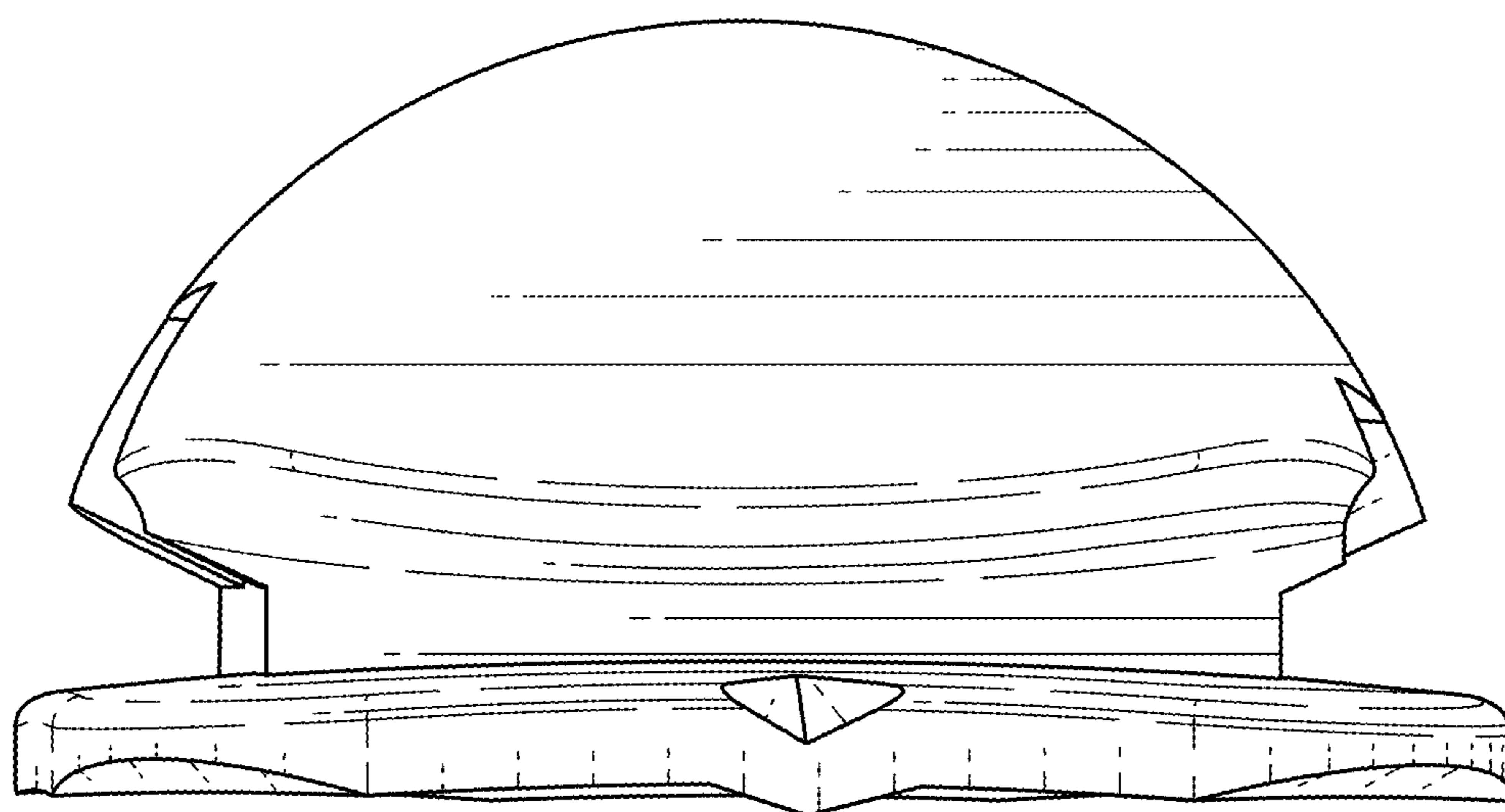

FIG. 7

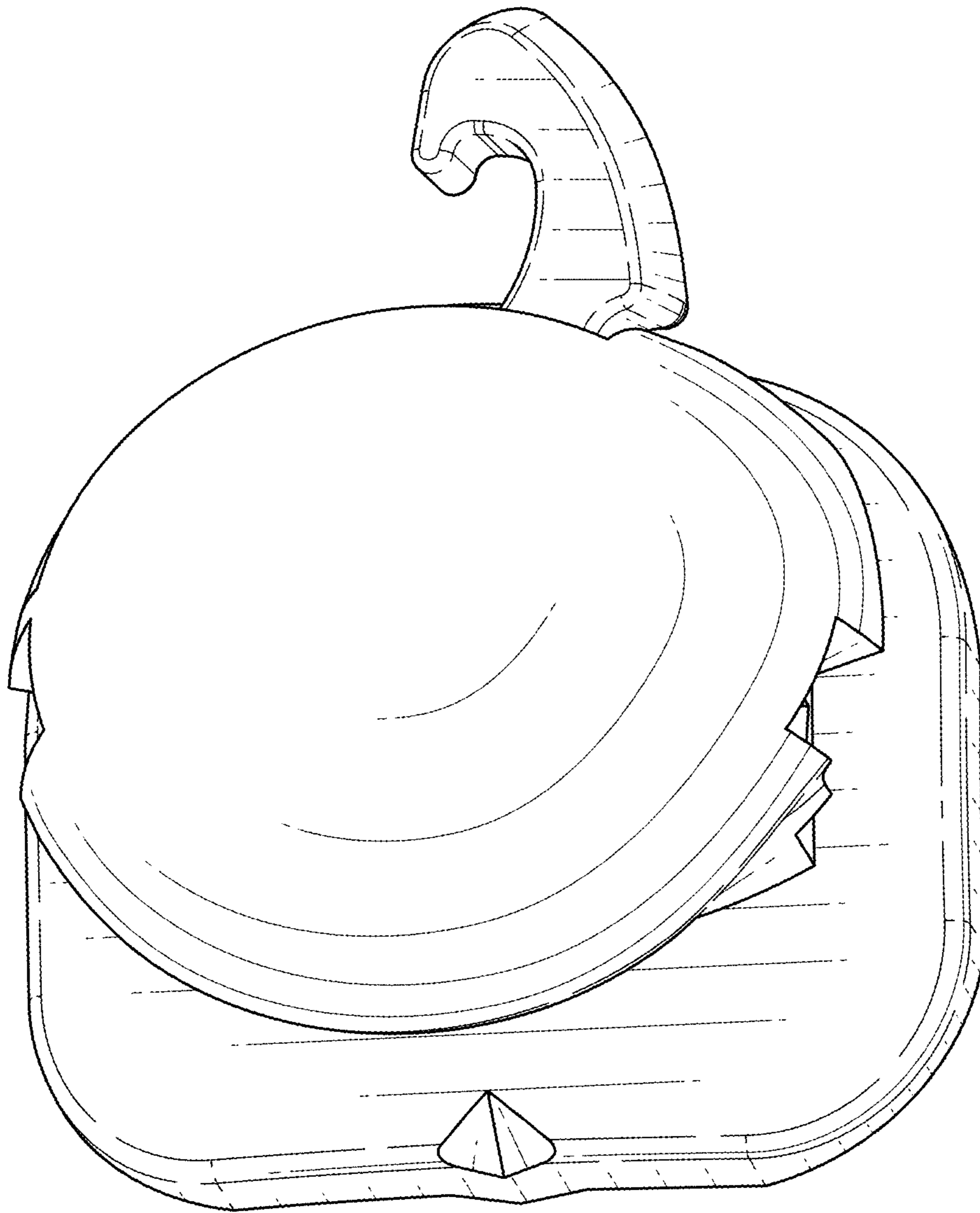

FIG. 8

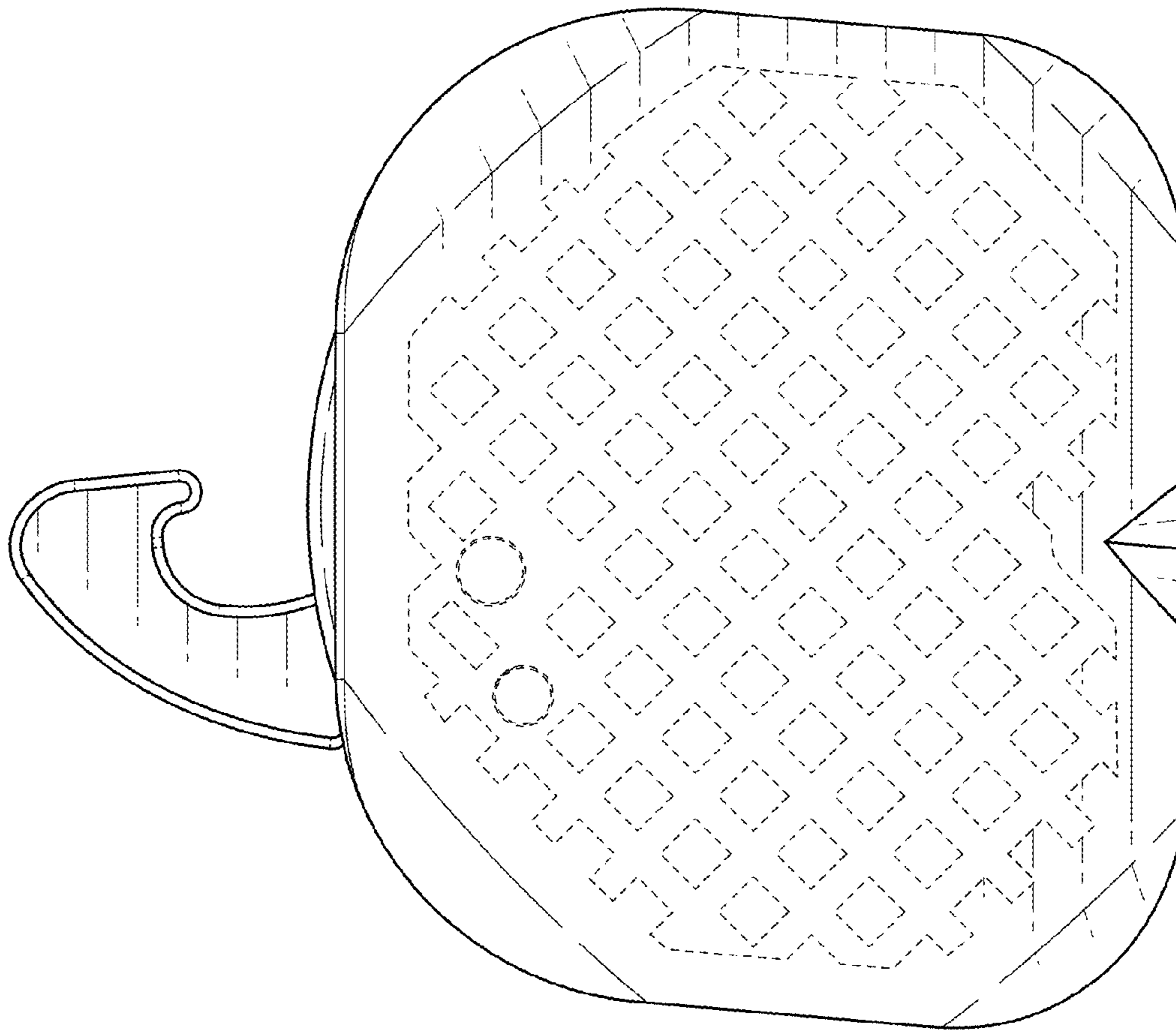

FIG. 10

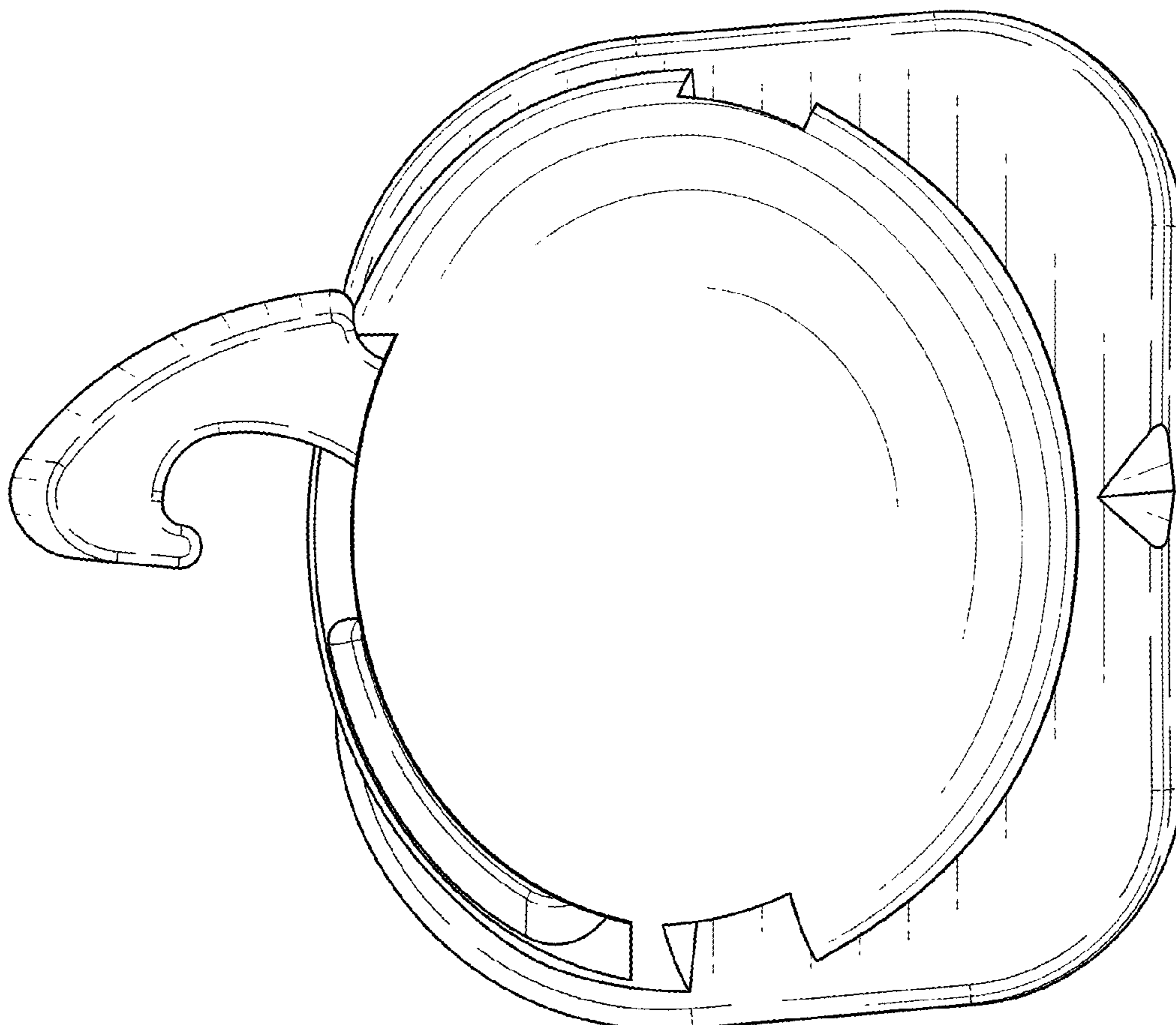

FIG. 9

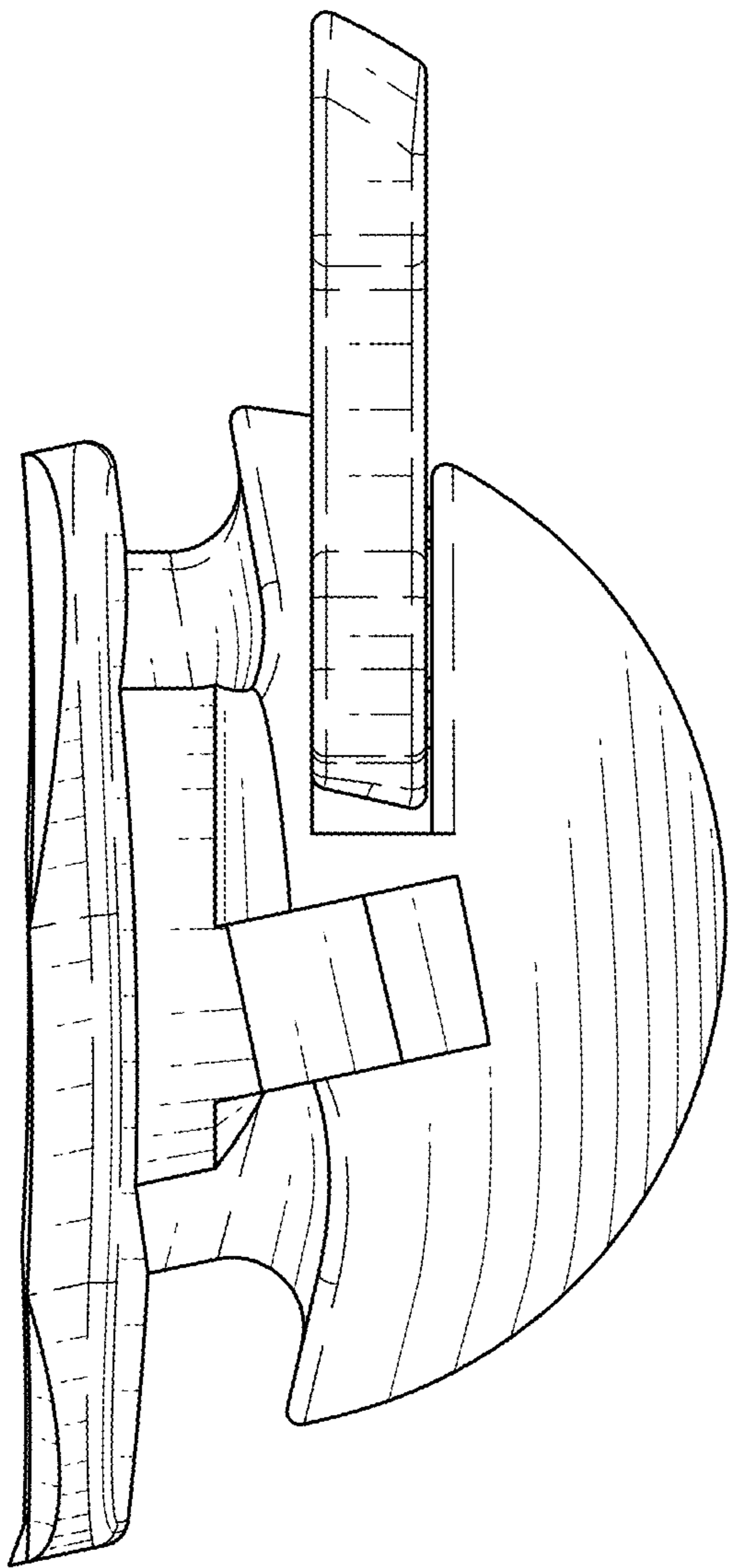

FIG. 11

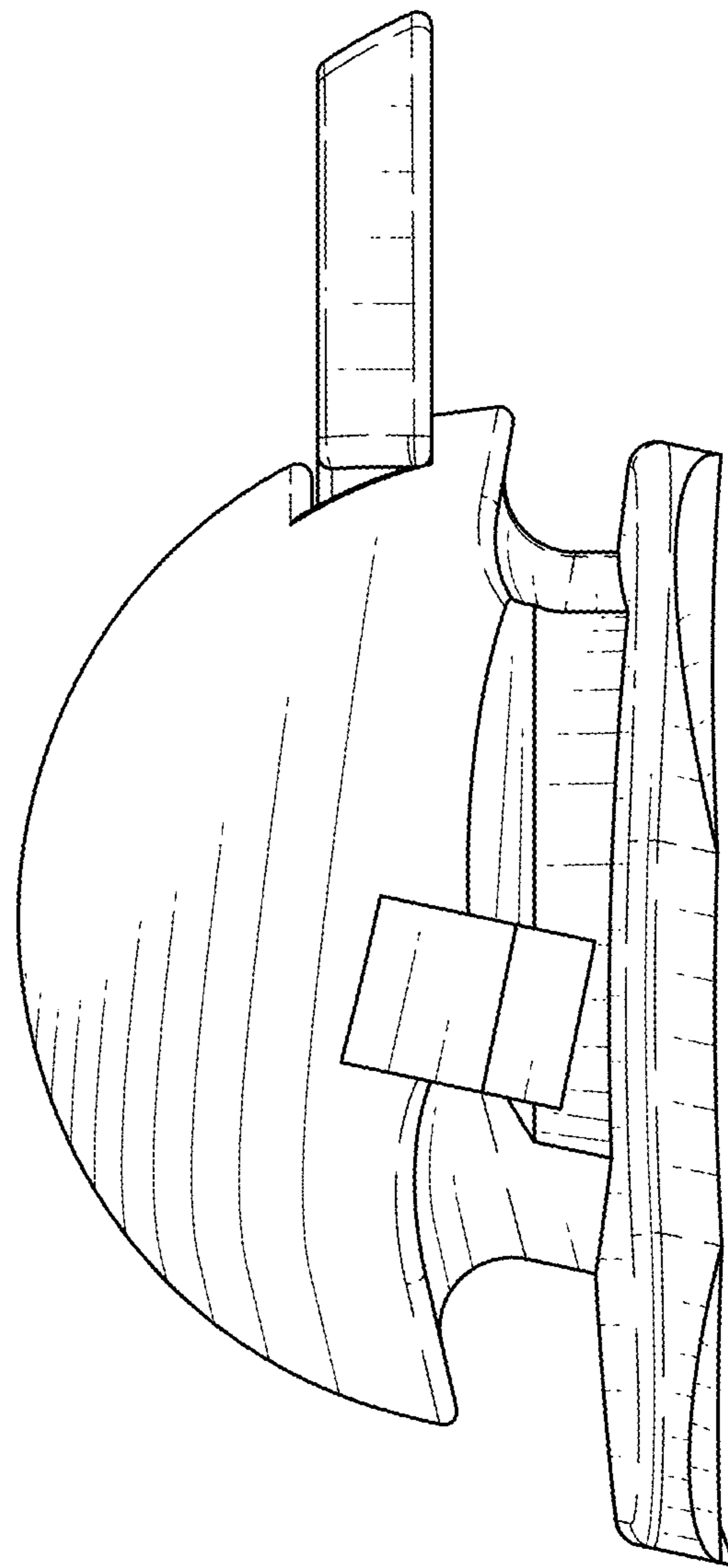

FIG. 12

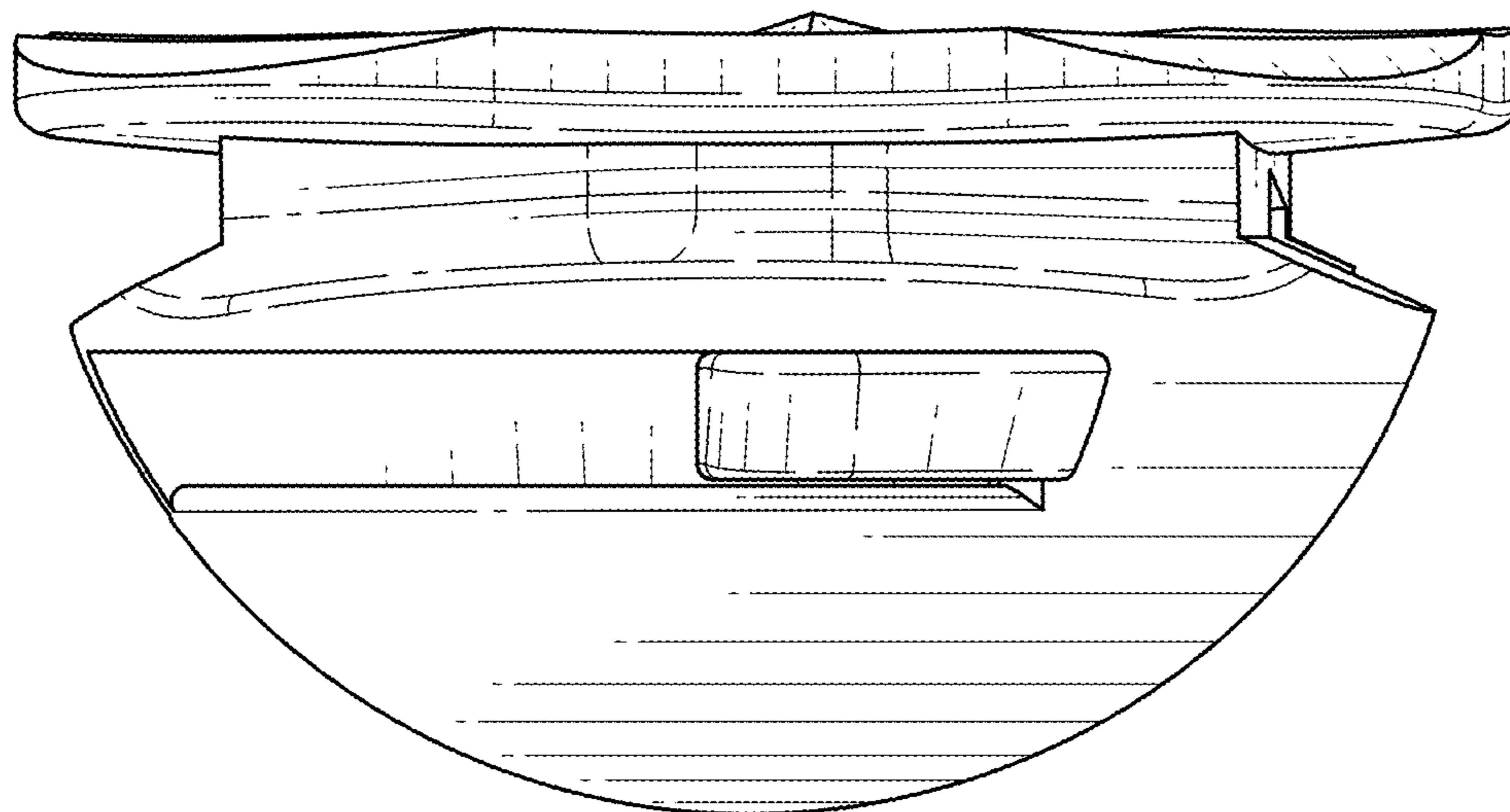

FIG. 13

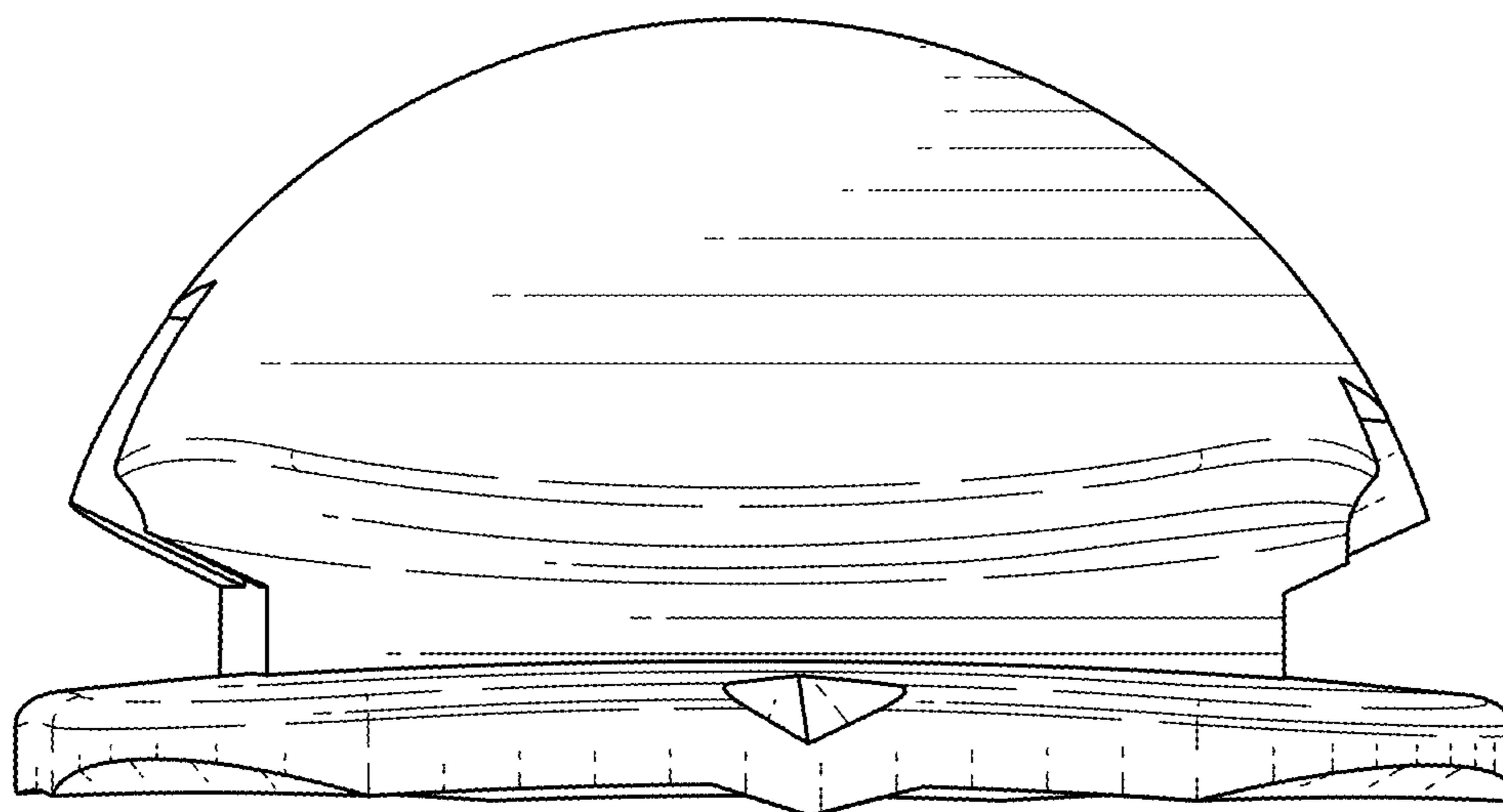

FIG. 14