



US00D940806S

(12) **United States Design Patent**
Hembert

(10) **Patent No.:** **US D940,806 S**

(45) **Date of Patent:** **** Jan. 11, 2022**

(54) **SPORTS BOARD (INFLATABLE RACE SUP)**

(71) Applicant: **DECATHLON**, Villeneuve d'Ascq (FR)

(72) Inventor: **Grégoire Hembert**, Hendaye (FR)

(73) Assignee: **DECATHLON**

(**) Term: **15 Years**

(21) Appl. No.: **29/719,104**

(22) Filed: **Dec. 31, 2019**

Related U.S. Application Data

(62) Division of application No. 29/594,264, filed on Feb. 16, 2017.

(30) **Foreign Application Priority Data**

Aug. 17, 2016 (EM) 003343920-0001

Aug. 17, 2016 (EM) 003343920-0002

(51) **LOC (13) Cl.** **21-01**

(52) **U.S. Cl.**
USPC **D21/769**

(58) **Field of Classification Search**
USPC D21/483, 542, 768-777; D12/300, 302,
D12/316

(Continued)

(56) **References Cited**

U.S. PATENT DOCUMENTS

4,798,549 A * 1/1989 Hirsch B63B 32/50
441/74

5,127,862 A * 7/1992 Pia B63B 32/50
441/79

(Continued)

OTHER PUBLICATIONS

Costway Inflatable Stand Up Paddle Board: Published May 28, 2017 [online], site visited Feb. 3, 2020. Available from Internet URL: https://www.amazon.co.uk/dp/B072M7BRFC/ref=cm_sw_r_tw_dp_U_x_0MgoEbJHKP54Z (Year: 2017).*

Primary Examiner — Michael C Stout

Assistant Examiner — Melvin L Davis

(74) *Attorney, Agent, or Firm* — Fross, Zelnick, Lehrman & Zissu, PC; Charles T. J. Weigell, Esq.

(57) **CLAIM**

The ornamental design for a sports board, as shown and described.

DESCRIPTION

The patent or application file contains at least one drawing/photograph executed in color. Copies of this patent with color drawing(s)/photograph(s) will be provided by the Office upon request and payment of the necessary fee.

FIG. 1 is a front perspective view of a sports board showing my new design;

FIG. 2 is a front view thereof;

FIG. 3 is a back view thereof;

FIG. 4 is a left side view thereof;

FIG. 5 is a right side view thereof;

FIG. 6 is a top view thereof;

FIG. 7 is a bottom view thereof;

FIG. 8 is a front perspective view of the sports board shown in FIG. 1, with red color and broken line portions;

FIG. 9 is a front view thereof;

FIG. 10 is a back view thereof;

FIG. 11 is a left side view thereof;

FIG. 12 is a right side view thereof;

FIG. 13 is a top view thereof; and,

FIG. 14 is a bottom view thereof.

The broken lines in the drawings depict portions of the sports board that form no part of the claimed design.

1 Claim, 6 Drawing Sheets
(3 of 6 Drawing Sheet(s) Filed in Color)

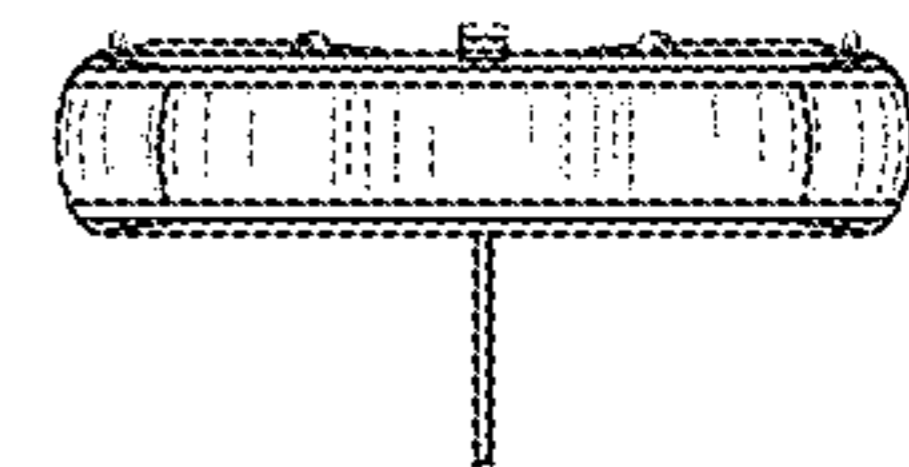
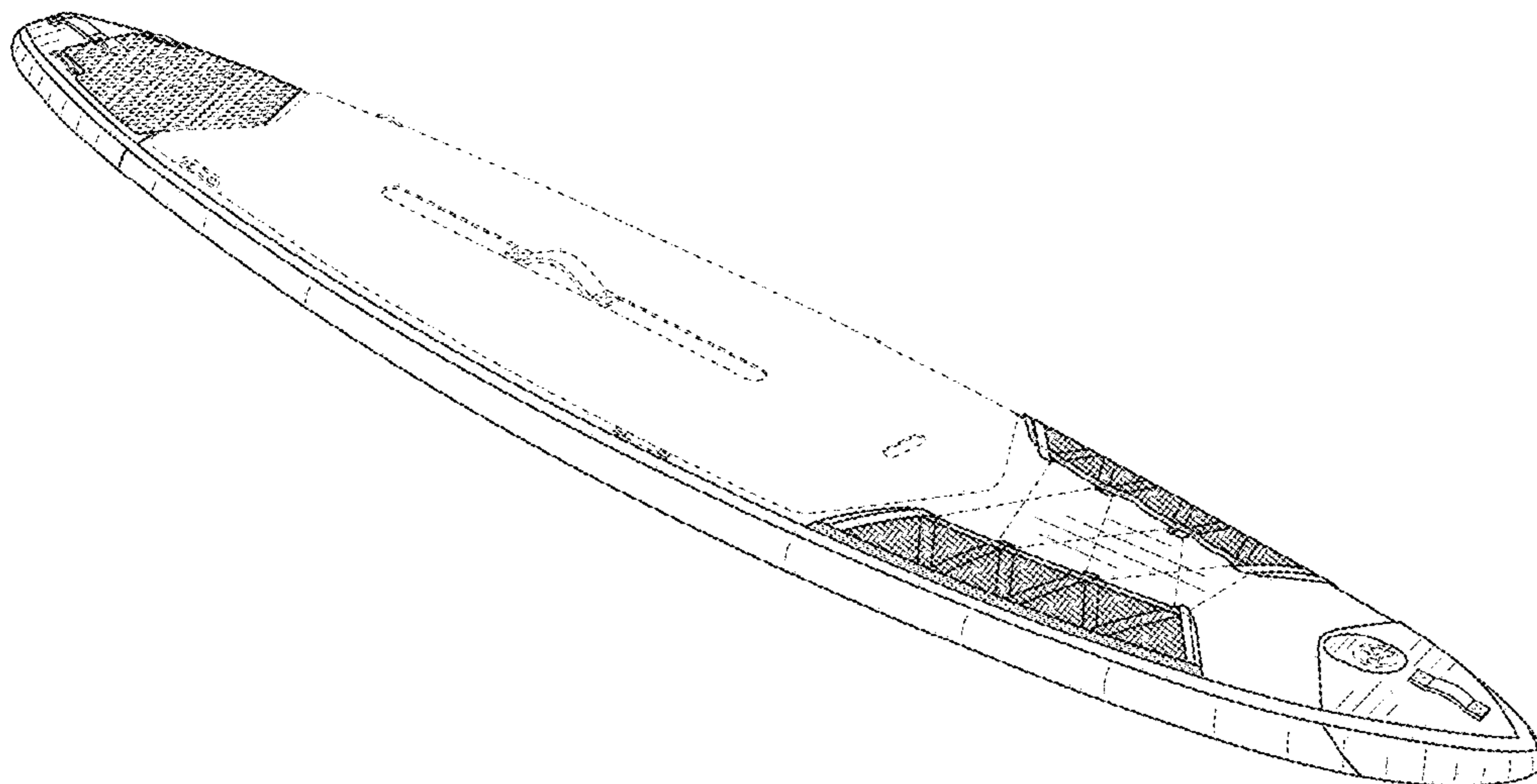

(58) **Field of Classification Search**

CPC B63B 35/7926
See application file for complete search history.

(56) **References Cited**

U.S. PATENT DOCUMENTS

D330,747 S * 11/1992 Pia D12/303
D334,419 S * 3/1993 Klein D21/769
D410,515 S * 6/1999 Alexander D21/769
D468,791 S * 1/2003 Greenberg D21/455
6,572,424 B2 * 6/2003 Harkrider B63C 11/49
114/66
D484,560 S * 12/2003 Lin D21/809
D515,684 S * 2/2006 Latone D23/366
7,121,911 B1 * 10/2006 Hickman B63B 32/66
441/79
D634,805 S * 3/2011 Cushing D21/769
D637,251 S * 5/2011 Bradley D21/769
D684,232 S * 6/2013 Vercelli D21/769
D713,917 S * 9/2014 Brodhead D21/769
D713,918 S * 9/2014 Brodhead D21/769
9,809,284 B2 * 11/2017 Hantz B32B 5/245
D816,179 S * 4/2018 de Grasse D21/803
D827,748 S * 9/2018 Desberg D21/765
D834,668 S * 11/2018 Duff D21/769
D838,328 S * 1/2019 Lockwood D21/769
D839,982 S * 2/2019 Berenson D21/803
D847,927 S * 5/2019 Duff D21/769
D865,889 S * 11/2019 Spear, Jr. D21/760
10,850,816 B2 * 12/2020 Schmidt B63B 32/57
2006/0049595 A1 * 3/2006 Crigler A63C 17/014
280/87.042
2015/0111448 A1 * 4/2015 McLelan B63B 32/00
441/74

* cited by examiner

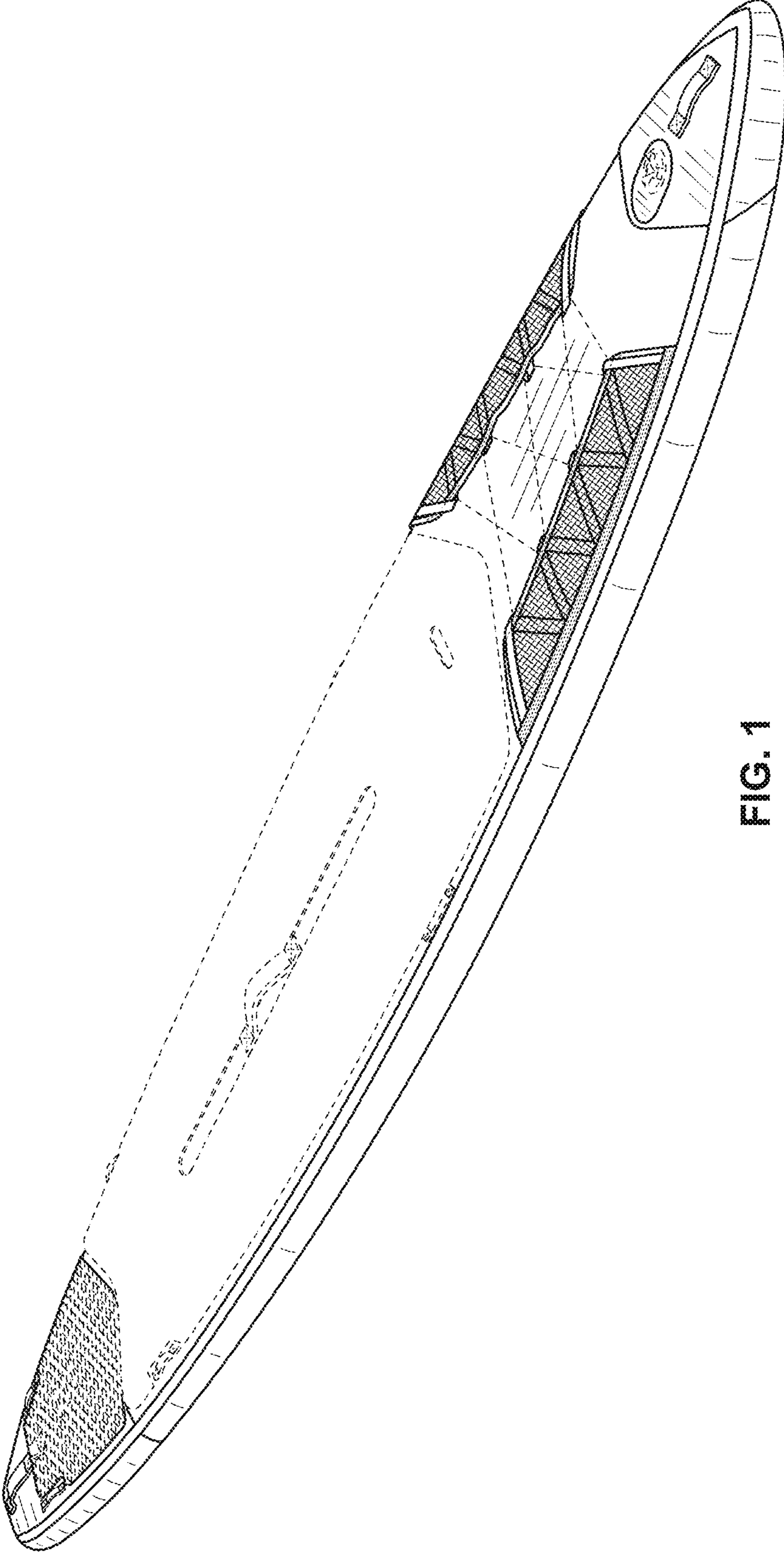

FIG. 1

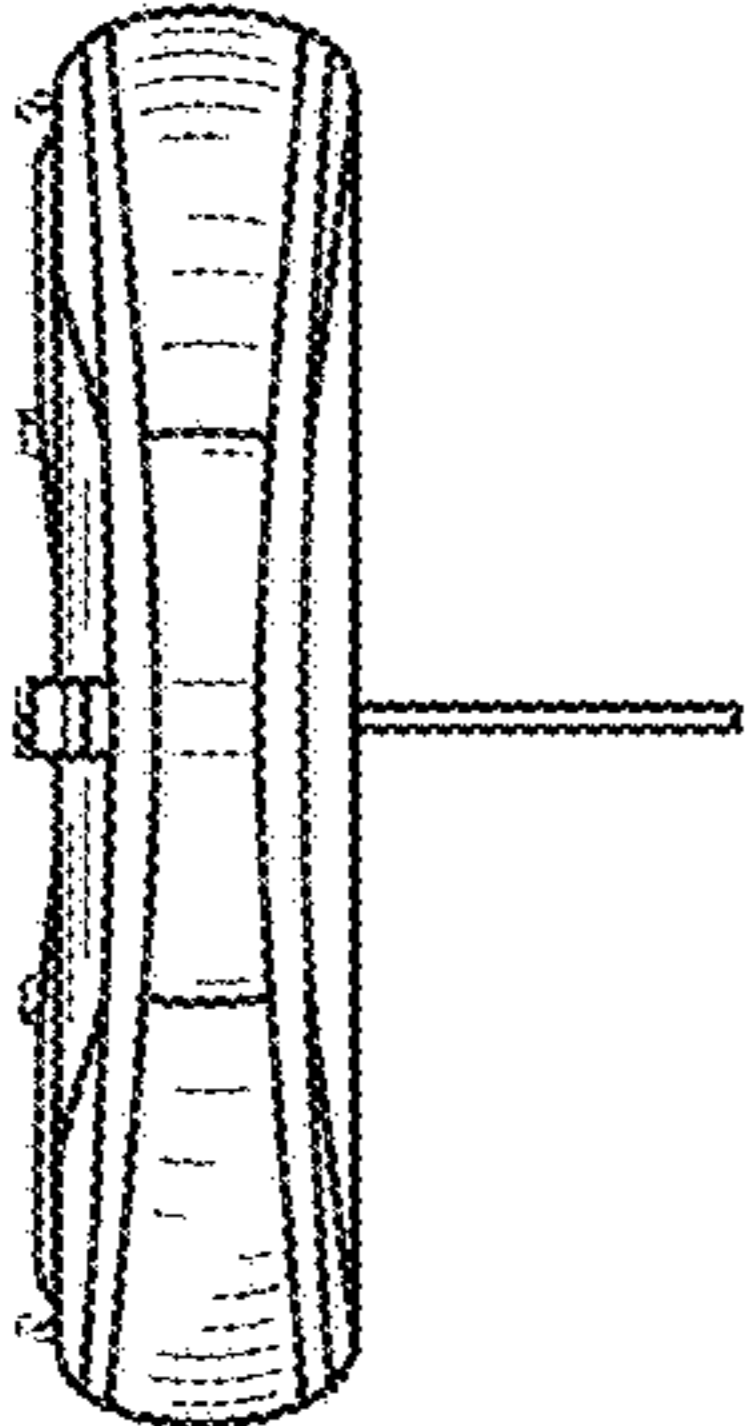

FIG. 2

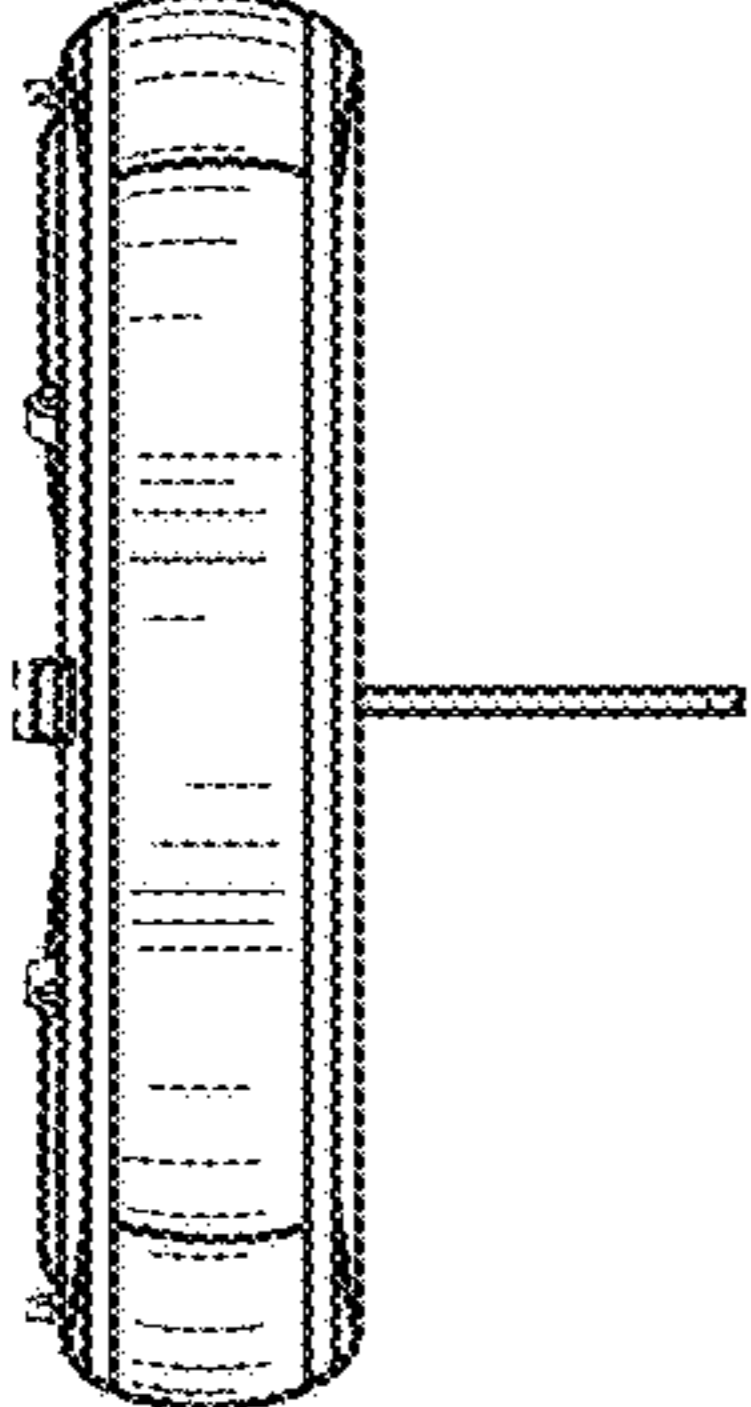

FIG. 3

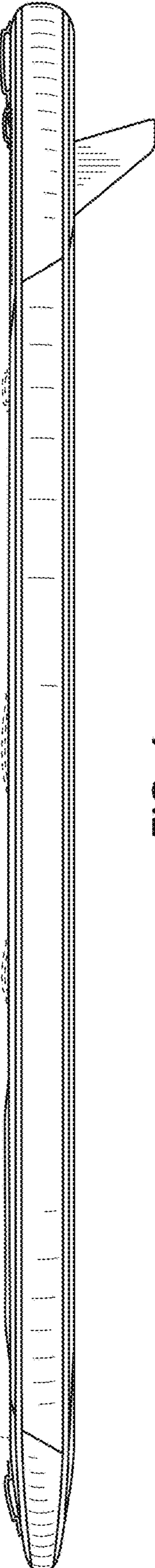

FIG. 4

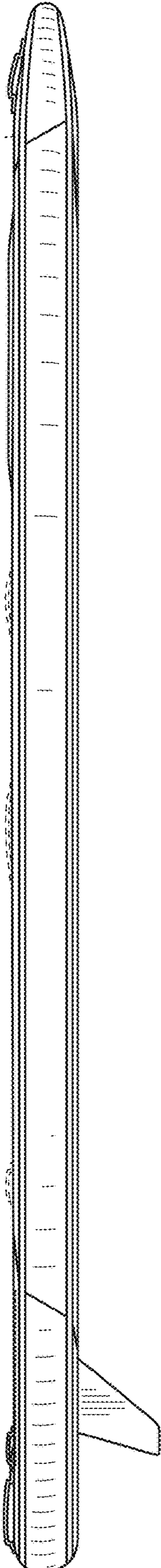

FIG. 5

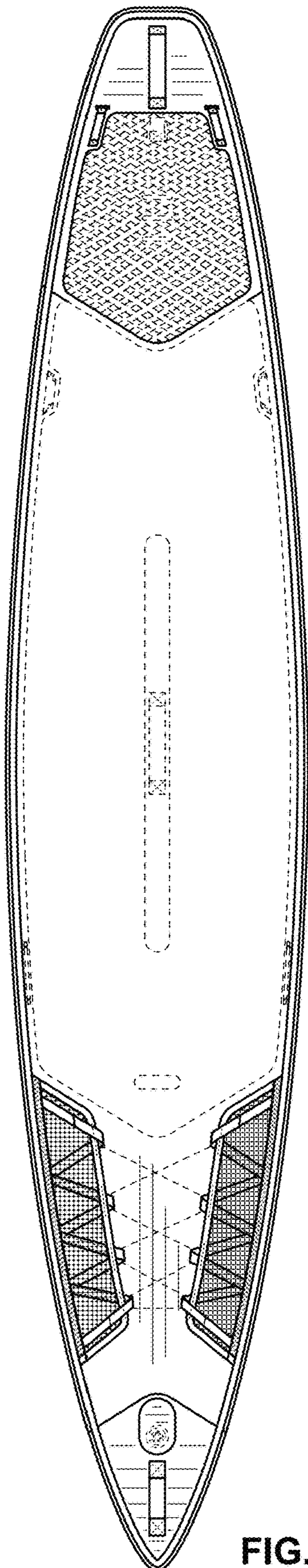

FIG. 6

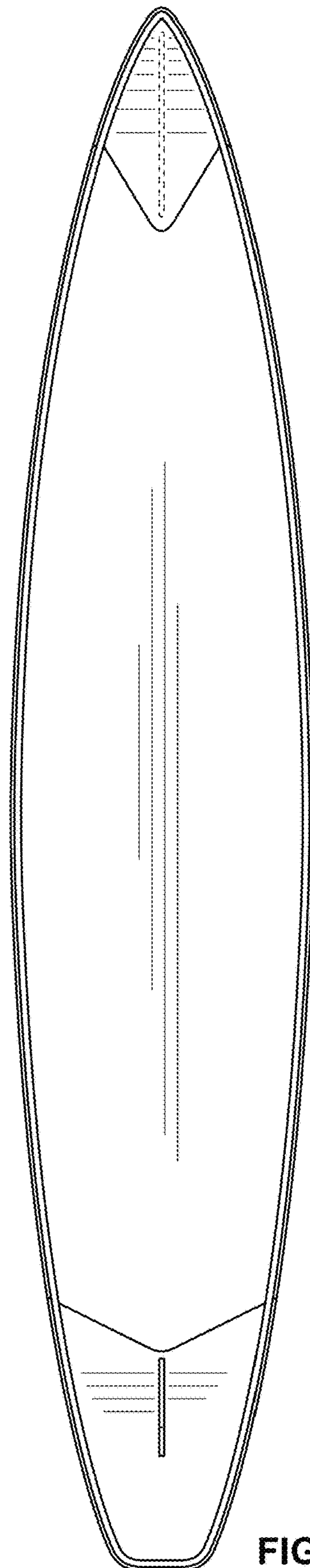

FIG. 7

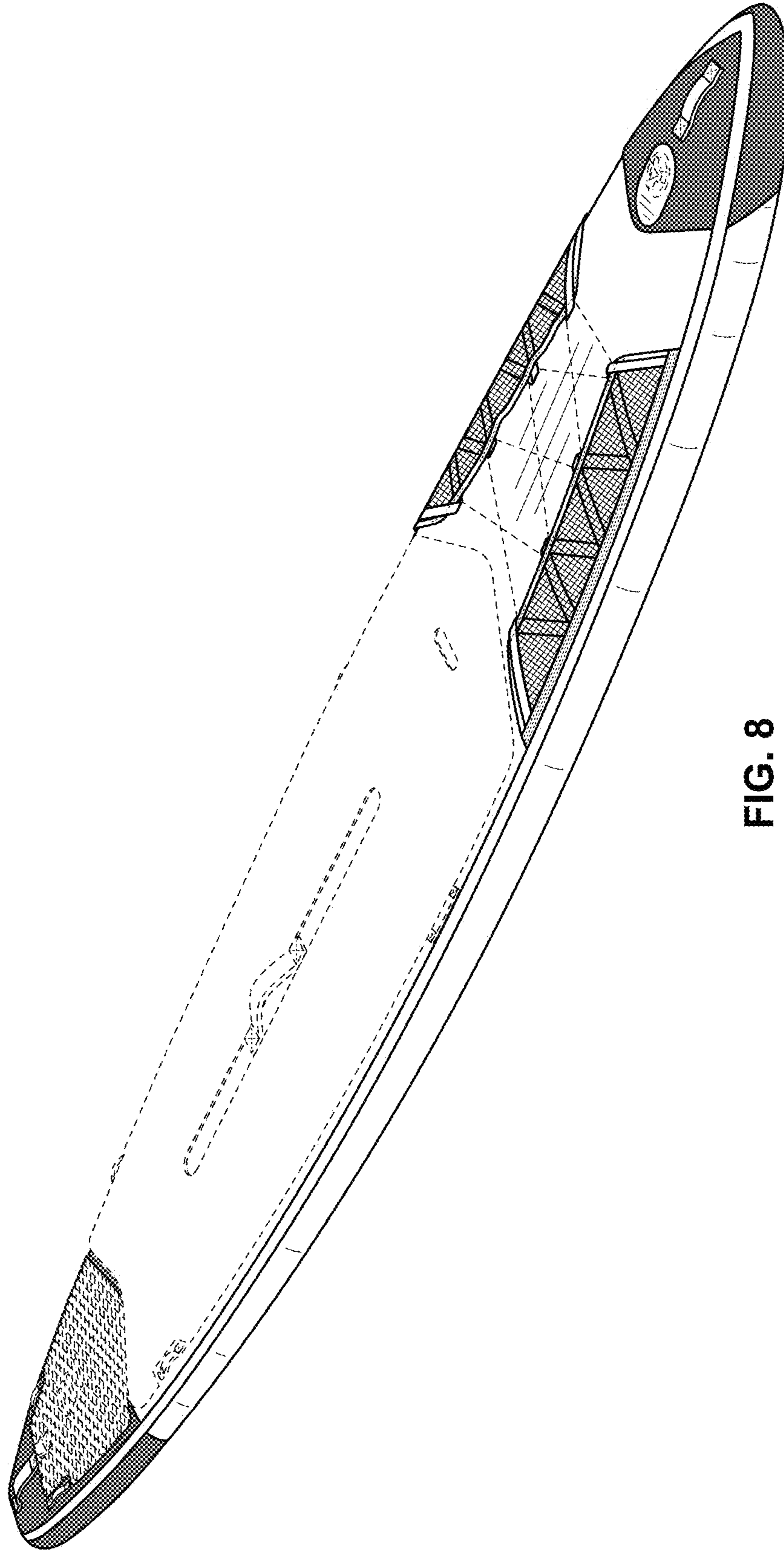

FIG. 8

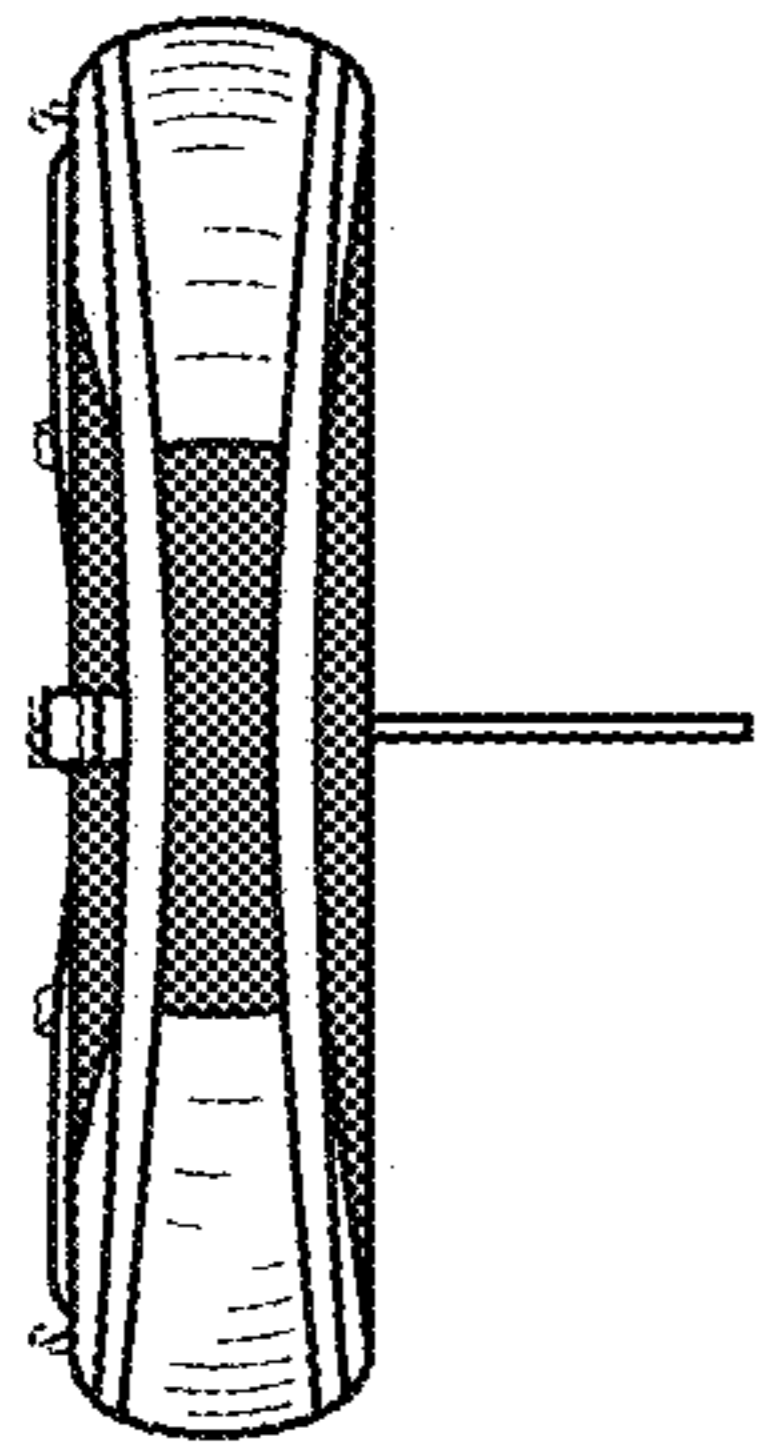

FIG. 9

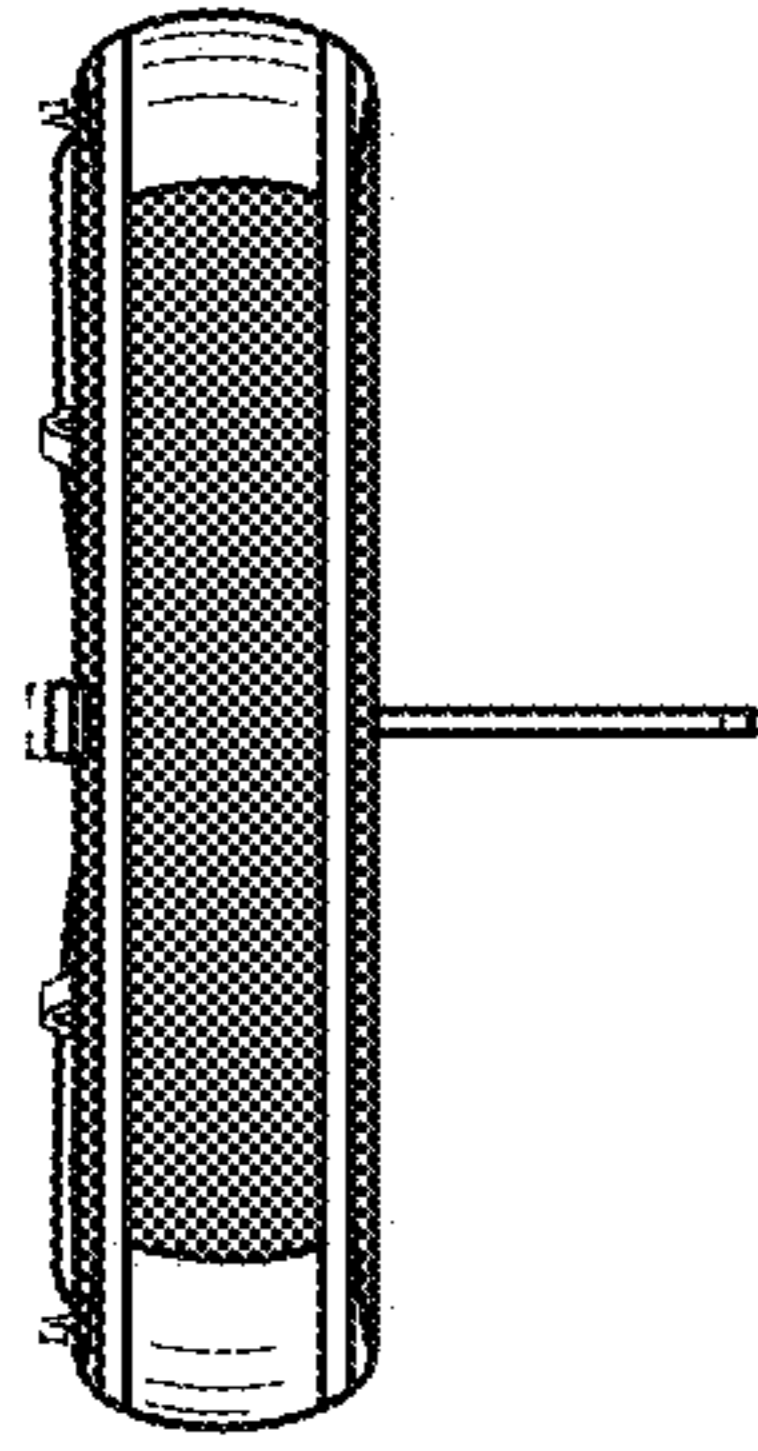

FIG. 10

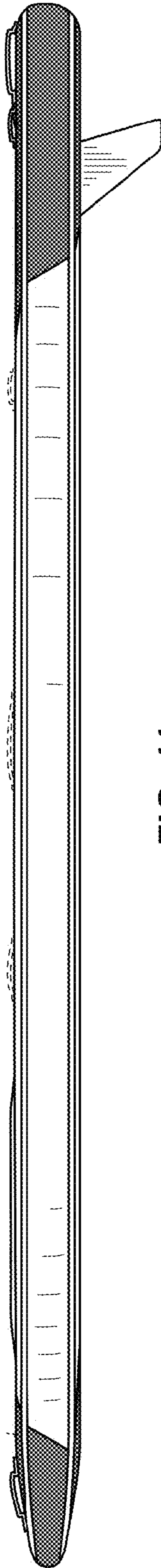

FIG. 11

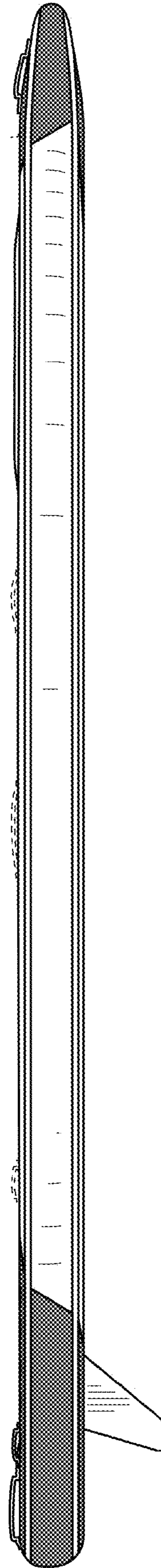

FIG. 12

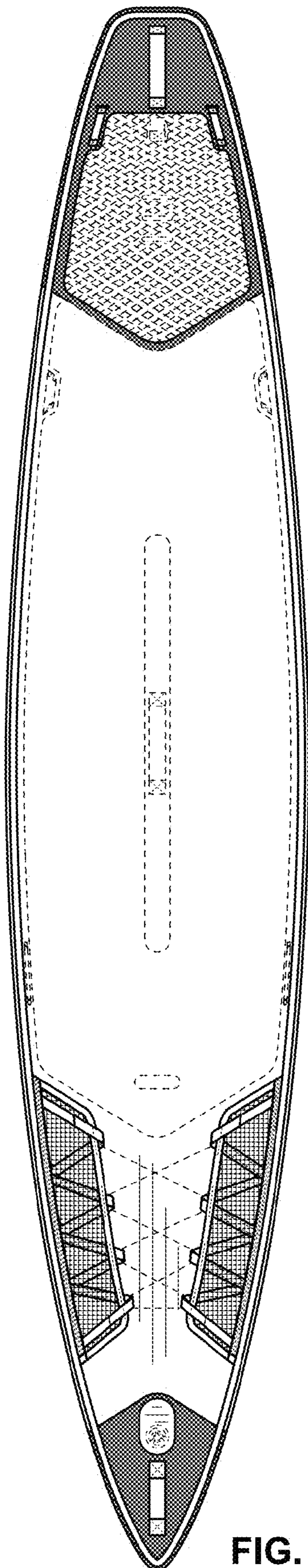

FIG. 13

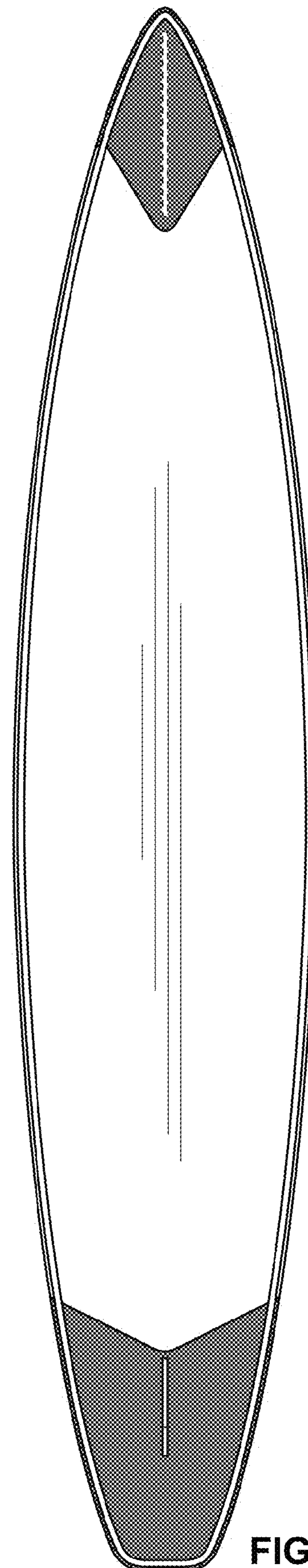

FIG. 14