



US00D940718S

(12) **United States Design Patent**
Poulton

(10) **Patent No.:** **US D940,718 S**
(45) **Date of Patent:** **** Jan. 11, 2022**

(54) **STORAGE DEVICE**

(71) Applicant: **Seagate Technology LLC**, Cupertino, CA (US)

(72) Inventor: **Neil Poulton**, Paris (FR)

(73) Assignee: **SEAGATE TECHNOLOGY LLC**, Fremont, CA (US)

(**) Term: **15 Years**

(21) Appl. No.: **29/718,035**

(22) Filed: **Dec. 20, 2019**

(51) **LOC (13) Cl.** **14-02**

(52) **U.S. Cl.**
USPC **D14/435**

(58) **Field of Classification Search**
USPC D14/110, 114, 125, 240, 242, 299-302, D14/314, 348-370, 435-438, 496, D14/478-480; D13/103, 119, 162, 184, D13/199; D18/1, 7, 9, 11; D3/273, 269, D3/201, 203.2, 207, 208, 212, 274, 247, D3/249; 361/679.33-679.45, 737, 752, 361/736, 728, 796, 797, 729, 730, 361/725-727; 340/710; 345/163, 173; 428/137-138, 140, 304.4, 457; 360/69, 360/97.02; D9/432; 235/441, 443, 487, 235/492, 493, 495; 257/678, 679, 693, 257/E23.064; 439/946, 948, 159; 438/121; 710/300-303; 174/250, 260, 174/52.1, 52.2; 206/38, 39.4, 39.5
CPC G06K 19/06196; G06K 19/072; G06K 19/0721; G06K 19/0722; G06K 19/0723; G06K 19/0724; G06K 19/0725; G06K 19/0726; G06K 19/0727; G06K 19/0728; G06K 19/073; G06K 19/07309; G06K 19/077; G06K 19/07701; G06K 19/07715; G06K 19/0772; G06K 19/07724; G06K 19/07726; G06K 19/07728; G06F 21/86; G06F 21/87; G06F 21/88; G06F 21/77-80; G06F 21/85-88; G06F 21/00; G06Q 20/3229;

G06Q 20/34; G06Q 20/341; G06Q 20/346; G06Q 20/349; G06Q 20/3563; G06Q 20/3567; G06Q 20/357; G06Q 20/3576; H05K 5/026; H05K 5/0256; H05K 5/0265; H05K 5/0269; H05K 5/0273; H05K 5/0278; H05K 5/0282; H05K 5/0286; H05K 5/0291; H05K 5/0295; H05K 5/03; H05K 5/04; H05K 5/06; H05K 5/061; H05K 5/062; H05K 5/063; H05K 5/064; H05K 5/065; H05K 5/066; H05K 5/067; H05K 5/068; H05K 5/069; H05K 7/00; H05K 7/005; H05K 7/02; H05K 7/023; H05K 7/026; H05K 7/04; H05K 7/10; H05K 7/1418; H05K 7/142; H05K 7/1424; H05K 7/1427-1439; H05K 7/1461; H05K 7/1464-1474; H05K 7/1479; H05K 7/1481; H05K 7/1485-1488; H05K 2201/09745; H05K 2201/09754; H05K 2201/09763; H05K 2201/09772; H05K 2201/098; H05K 2201/09818; H05K 2201/10; H05K 2201/10007; H04N 2201/216

See application file for complete search history.

(56)

References Cited

U.S. PATENT DOCUMENTS

D39,344 S *	6/1908	Schoettle	D9/418
D263,919 S *	4/1982	Anderson, Jr.	D7/388
D283,137 S *	3/1986	Hamar	D18/11
D283,138 S *	3/1986	Hamar	D18/11
D308,750 S *	6/1990	Hillinger	206/349
D312,534 S *	12/1990	Nelson	D10/80
D316,932 S *	5/1991	Escher, Jr.	D3/265
D318,565 S *	7/1991	Kearney	D3/294
D322,165 S *	12/1991	Lloyd	D3/273
D338,457 S *	8/1993	Kim	D14/322
D338,656 S *	8/1993	Spayde	D14/341
D343,121 S *	1/1994	Liska	D28/78
D345,650 S *	4/1994	Boyd	D3/294
5,299,685 A *	4/1994	Chin	B65D 81/02 206/320
D346,793 S *	5/1994	Iino	D14/341
D348,252 S *	6/1994	Mizunashi	D13/179
5,324,202 A *	6/1994	Meyers	B43L 1/123 434/410

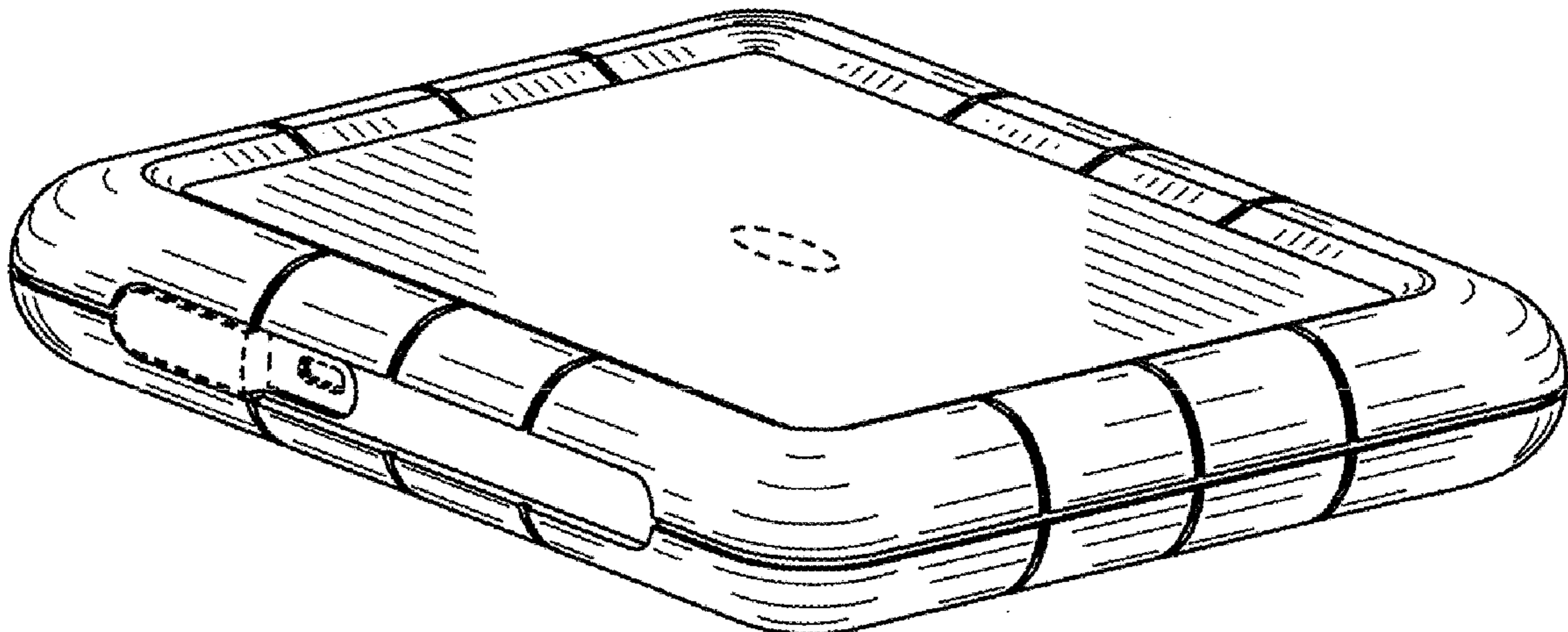

US D940,718 S

5,360,108	A *	11/1994	Alagia	H01H 9/0242 206/320	6,480,377	B2 *	11/2002	Genest	G06F 1/1626 345/169
5,368,159	A *	11/1994	Doria	H01H 9/0242 206/320	D467,971	S *	12/2002	Mak	D21/469
D355,360	S *	2/1995	Mund	D3/294	6,552,899	B2 *	4/2003	Ronzani	G06F 1/203 361/679.54
5,386,964	A *	2/1995	Mayo	B43L 3/00 248/346.01	6,568,650	B2 *	5/2003	Helmetsie	F16M 13/00 248/205.2
D357,918	S *	5/1995	Doria	D14/218	D477,714	S *	7/2003	Cunningham	D3/273
D359,031	S *	6/1995	Hatano	D14/336	D478,055	S *	8/2003	Jing	D13/179
D359,984	S *	7/1995	Mak	D14/390	D481,868	S *	11/2003	Cunningham	D3/273
D360,151	S *	7/1995	Kim	D10/75	6,643,656	B2 *	11/2003	Peterson	G06F 16/9024
5,468,151	A *	11/1995	Egelandsdal	G09B 23/288 434/265	6,698,608	B2 *	3/2004	Parker	A45C 13/008 220/23.87
5,505,328	A *	4/1996	Stribiak	A01K 97/06 206/315.11	6,700,775	B1 *	3/2004	Chuang	G06F 1/1626 361/679.01
5,570,780	A *	11/1996	Miller	A45C 13/021 206/305	6,707,668	B2 *	3/2004	Huang	G06F 1/203 248/676
5,583,742	A *	12/1996	Noda	H01M 50/30 361/679.21	D489,717	S *	5/2004	Hsieh	D14/341
5,632,373	A *	5/1997	Kumar	G06F 1/1628 206/305	6,749,158	B2 *	6/2004	Timm	A47B 21/0314 108/50.02
5,674,104	A *	10/1997	Ohashi	B43K 23/04 401/206	D493,787	S *	8/2004	Avery	D14/345
5,695,345	A *	12/1997	Weiner	G09B 5/062 434/308	6,775,128	B2 *	8/2004	Leitao	G06F 1/1607 206/701
D389,816	S *	1/1998	Horiki	D14/318	D498,754	S *	11/2004	Blyth	D14/341
D391,761	S *	3/1998	Lee	D28/83	D500,316	S *	12/2004	Lynch	D14/345
D392,625	S *	3/1998	Tang	D14/324	D501,007	S *	1/2005	Heng	D14/341
D405,480	S *	2/1999	Yamazaki	D21/475	D501,997	S *	2/2005	Hassett	D12/416
5,871,097	A *	2/1999	Shida	B65D 81/30 206/521	D502,744	S *	3/2005	Hussaini	D21/333
5,887,723	A *	3/1999	Myles	G06F 1/1626 206/760	D502,945	S *	3/2005	Huang	D14/341
D411,179	S *	6/1999	Toyosato	D14/344	D504,472	S *	4/2005	Liu	D21/324
D415,121	S *	10/1999	Uematsu	D14/328	6,896,134	B2 *	5/2005	Russell	A45C 3/02 206/320
D419,297	S *	1/2000	Richardson	D3/273	D505,950	S *	6/2005	Summit	D14/341
D419,768	S *	2/2000	Richardson	D3/273	D509,960	S *	9/2005	Yeung	D3/281
6,030,140	A *	2/2000	Karten	B42F 13/0006 206/206	D510,044	S *	9/2005	Ribeiro	D10/78
6,041,924	A *	3/2000	Tajima	H04B 1/08 206/305	D510,576	S *	10/2005	Summit	D14/341
D423,772	S *	5/2000	Cooper	D3/201	D514,123	S *	1/2006	Naruki	D14/203.3
6,071,082	A *	6/2000	Lecinski	F04D 25/166 361/695	D514,808	S *	2/2006	Morine	D3/273
D429,884	S *	8/2000	Zurwelle	D3/276	6,995,976	B2 *	2/2006	Richardson	G06F 1/1626 206/320
D430,398	S *	9/2000	Kimura	D3/273	D516,309	S *	3/2006	Richardson	D3/273
D435,591	S *	12/2000	Wyant	D19/26	D516,553	S *	3/2006	Richardson	D14/341
6,179,122	B1 *	1/2001	Moncrief	G06F 1/1628 206/320	D516,554	S *	3/2006	Richardson	D14/341
D439,897	S *	4/2001	Williams	D14/345	D516,807	S *	3/2006	Richardson	D3/273
6,217,835	B1 *	4/2001	Riley	A61L 2/26 206/1.5	D518,394	S *	4/2006	Lipscomb	D10/78
6,223,896	B1 *	5/2001	Bell	G06F 1/1628 174/378	7,025,274	B2 *	4/2006	Solomon	G06F 1/1669 235/472.01
6,233,148	B1 *	5/2001	Shen	G11B 33/142 165/121	D522,002	S *	5/2006	Cheng	D14/439
6,239,971	B1 *	5/2001	Yu	G06F 1/203 165/104.33	7,038,909	B1 *	5/2006	Chen	G06F 1/203 361/679.48
D448,167	S *	9/2001	Pangerc	D3/273	7,046,508	B2 *	5/2006	Lin	A63F 13/02 361/679.59
6,286,667	B1 *	9/2001	Lee	G06F 15/02 206/305	D524,046	S *	7/2006	Pangerc	D3/273
D449,931	S *	11/2001	Snider	D3/294	D525,422	S *	7/2006	Williams	D3/218
6,313,982	B1 *	11/2001	Hino	A45C 13/002 206/320	D531,022	S *	10/2006	Au	D3/294
D454,429	S *	3/2002	Hussaini	D3/274	7,158,376	B2 *	1/2007	Richardson	G06F 1/1626 361/679.56
D455,746	S *	4/2002	Ronzani	D14/344	7,161,799	B2 *	1/2007	Lim	G06F 1/203 248/205.2
D456,398	S *	4/2002	Horiki	D14/318	D537,441	S *	2/2007	Bruker	D14/341
6,388,659	B2 *	5/2002	Myerson	G06F 1/1626 345/169	7,180,735	B2 *	2/2007	Thomas	G06F 1/1626 206/701
D459,885	S *	7/2002	Hart	D3/276	D538,801	S *	3/2007	Taylor	D14/341
D460,294	S *	7/2002	Webb	D7/601	D539,795	S *	4/2007	Shi	D14/315
D462,955	S *	9/2002	Van Note	D14/315	D542,032	S *	5/2007	Williams	D3/269
6,445,577	B1 *	9/2002	Madsen	G06F 1/1628 206/320	D542,856	S *	5/2007	Lim	D14/401
D464,196	S *	10/2002	Parker	D3/201	7,221,562	B2 *	5/2007	Song	G06F 1/1679 361/679.06
D465,330	S *	11/2002	Parker	D3/201	D543,700	S *	6/2007	Parker	D14/315
					D544,540	S *	6/2007	Forrest	D19/27
					7,230,823	B2 *	6/2007	Richardson	G06F 1/1626 220/23.91
					7,236,356	B2 *	6/2007	Ulla	G06F 1/1626 361/679.21
					D548,734	S *	8/2007	Huttunen	D14/341
					D551,664	S *	9/2007	Lin	D14/341
					D551,846	S *	10/2007	Ko	D3/201

US D940,718 S

D552,184 S *	10/2007	Hussaini	D14/496	D633,088 S *	2/2011	Liao	D14/341
D552,352 S *	10/2007	Lin	D3/294	D633,089 S *	2/2011	Hsu	D14/341
7,293,649 B2 *	11/2007	Gelphman	A45C 13/02	7,886,903 B1 *	2/2011	Wurzelbacher, Jr.	
			190/124				G06F 1/1616
7,301,765 B2 *	11/2007	Huang	G06F 1/203				206/320
			361/679.48	7,889,489 B2 *	2/2011	Richardson	G06F 1/1632
D557,897 S *	12/2007	Richardson	D3/294				361/679.32
7,312,984 B2 *	12/2007	Richardson	G06F 1/1626	D633,294 S *	3/2011	Jamison	D3/282
			206/701	D633,487 S *	3/2011	Kim	D14/315
D558,754 S *	1/2008	Takemasa	D14/328	D633,489 S *	3/2011	Kim	D14/315
D559,327 S *	1/2008	Luk	D21/330	D633,490 S *	3/2011	Kim	D14/315
D559,859 S *	1/2008	Kim	D14/129	D633,905 S *	3/2011	Ke	D14/315
D563,672 S *	3/2008	Cornwell	D3/294	D634,313 S *	3/2011	Fitzpatrick	D14/250
7,359,184 B2 *	4/2008	Lord	G06F 1/1616	D634,741 S *	3/2011	Richardson	D14/250
			206/320	D634,781 S *	3/2011	Hertrich, Jr.	D19/26
7,366,925 B2 *	4/2008	Keely	G06F 1/1628	7,907,394 B2 *	3/2011	Richardson	G06F 1/1613
			713/300				361/679.3
D570,593 S *	6/2008	Justiss	D3/201	7,909,161 B2 *	3/2011	Sween	A45C 5/03
D571,757 S *	6/2008	Kesler	D14/137				206/320
D571,799 S *	6/2008	Ogasawara	D14/341	D641,756 S *	7/2011	Hsieh	D14/440
D572,479 S *	7/2008	Buck	D3/282	D647,526 S *	10/2011	Vandiver	D14/440
D572,480 S *	7/2008	Buck	D3/294	D668,660 S *	10/2012	Norfolk	D14/440
D573,143 S *	7/2008	Park	D14/341	D668,661 S *	10/2012	Norfolk	D14/440
D573,597 S *	7/2008	Shieh	D14/439	D674,801 S *	1/2013	Wharram	D14/440
D573,789 S *	7/2008	Eisenbraun	D3/218	D694,759 S	12/2013	Chang et al.	
D574,615 S *	8/2008	Picot	D3/289	D740,809 S	10/2015	Kwon et al.	
7,425,944 B1 *	9/2008	Peterson	G06F 16/9024	D795,874 S	8/2017	Szeremeta	
			345/156	D805,774 S	12/2017	Sun	
D578,117 S *	10/2008	Freed	D14/341	D819,023 S	5/2018	Shim	
D579,202 S *	10/2008	Grenier	D3/294	D829,213 S	9/2018	Szeremeta et al.	
D582,149 S *	12/2008	Tan	D3/201	D856,326 S *	8/2019	Shim	D14/356
D586,798 S *	2/2009	Tanaka	D14/315	D921,638 S *	6/2021	Li	D14/440
D587,896 S *	3/2009	Aipa	D3/201	D922,392 S *	6/2021	Chan	D14/440
D591,801 S *	5/2009	Mak	D21/469	D929,732 S *	9/2021	Ding	D3/273
7,533,782 B2 *	5/2009	Parker	A45C 13/008	2002/0071550 A1 *	6/2002	Pletikosa	G06F 1/1626
			220/324				379/433.01
D598,407 S *	8/2009	Richardson	D14/138 AA	2002/0085342 A1 *	7/2002	Chen	G06F 1/1616
D600,013 S *	9/2009	McCune	D3/273				361/679.55
D601,139 S *	9/2009	Huang	D14/341	2002/0101705 A1 *	8/2002	Genest	G06F 1/1626
7,594,576 B2 *	9/2009	Chen	G06F 1/1628				361/679.43
			206/305	2003/0039094 A1 *	2/2003	Sarkinen	H05K 5/0226
D602,456 S *	10/2009	Aithal	D14/138 AA				361/679.27
D604,289 S *	11/2009	Andre	D14/315	2003/0174467 A1 *	9/2003	Lu	G06F 1/266
D604,511 S *	11/2009	Lai	D3/295				361/695
D605,141 S *	12/2009	Jones	D13/179	2003/0210523 A1 *	11/2003	Tuttle	H05K 5/0213
D605,850 S *	12/2009	Richardson	D3/218				361/679.6
D606,305 S *	12/2009	Lee	D3/269	2003/0217940 A1 *	11/2003	Russell	G06F 1/1628
D606,986 S *	12/2009	de Jong	D14/250				206/320
D607,444 S *	1/2010	Ferrari	D14/250	2003/0222149 A1 *	12/2003	Solomon	G06F 1/1669
D607,445 S *	1/2010	Ferrari	D14/250				235/472.01
D607,446 S *	1/2010	Ferrari	D14/250	2003/0223184 A1 *	12/2003	Nakamura	H04N 5/2252
7,663,876 B2 *	2/2010	Lin	G06F 1/203				361/679.02
			361/679.47	2004/0112776 A1 *	6/2004	Lord	G06F 1/1616
D610,807 S *	3/2010	Bau	D3/269				206/320
D612,827 S *	3/2010	Song	D14/138 AB	2004/0177658 A1 *	9/2004	Mitchell	E05G 1/005
7,688,580 B2 *	3/2010	Richardson	G06F 1/1632				70/58
			361/679.56	2004/0264126 A1 *	12/2004	Wells	G06F 1/1656
D615,299 S *	5/2010	Agarwal	D3/269				361/679.46
D616,849 S *	6/2010	Fujimura	D14/138 AD	2005/0052831 A1 *	3/2005	Chen	G06F 1/1683
D619,139 S *	7/2010	Ho	D14/447				361/679.11
D620,000 S *	7/2010	Bau	D14/250	2005/0174727 A1 *	8/2005	Thomas	G06F 1/1626
D620,001 S *	7/2010	Reed	D14/315				361/679.56
D621,821 S *	8/2010	Richardson	D14/250	2006/0007645 A1 *	1/2006	Chen	A45C 11/00
D623,186 S *	9/2010	Ludlum	D14/371				361/679.04
D623,644 S *	9/2010	Hsu	D14/315	2006/0042996 A1 *	3/2006	Picot	A45C 13/02
D623,646 S *	9/2010	Peng	D14/324				206/586
D623,647 S *	9/2010	Hsu	D14/324	2006/0044288 A1 *	3/2006	Nakamura	G06F 1/1626
D623,648 S *	9/2010	Hsu	D14/324				345/179
D624,067 S *	9/2010	Peng	D14/315	2006/0061964 A1 *	3/2006	Cheng	G06F 1/1632
D624,069 S *	9/2010	Peng	D14/324				361/679.41
D624,073 S *	9/2010	Peng	D14/341	2006/0104021 A1 *	5/2006	Chen	G06F 1/1628
7,800,896 B2 *	9/2010	Takizawa	G06F 1/1601				361/679.56
			361/679.41	2006/0274493 A1 *	12/2006	Richardson	H05K 5/068
D625,698 S *	10/2010	Miyazaki	D14/138 AB				361/679.4
D626,123 S *	10/2010	Peng	D14/324	2007/0158220 A1 *	7/2007	Cleereman	A45C 11/00
D627,775 S *	11/2010	Li	D14/324				206/320
7,850,032 B2 *	12/2010	Carnevali	B63B 49/00				
			220/4.22				

2007/0176902	A1 *	8/2007	Newman	G06F 3/0202	345/168
2007/0227923	A1 *	10/2007	Kidakarn	G06F 1/1681	206/320
2007/0247801	A1 *	10/2007	Bekele	G06F 1/203	361/679.55
2008/0084396	A1 *	4/2008	Pen	G06F 1/1669	345/168
2008/0194139	A1 *	8/2008	Chan	H04B 1/3888	439/521
2008/0308437	A1 *	12/2008	Lin	G06F 1/1616	206/320
2009/0009945	A1 *	1/2009	Johnson	G06F 1/1613	361/679.27
2009/0080153	A1 *	3/2009	Richardson	A45C 13/002	361/679.56
2009/0107661	A1 *	4/2009	Andersson	F28D 9/005	165/168
2009/0111543	A1 *	4/2009	Tai	H04B 1/3888	455/575.8
2009/0181729	A1 *	7/2009	Griffin, Jr.	H04N 5/2254	455/575.1
2010/0008028	A1 *	1/2010	Richardson	H04R 1/028	361/679.01
2010/0203931	A1 *	8/2010	Hynecek	H04M 1/0202	455/575.8
2010/0224519	A1 *	9/2010	Kao	A45C 11/00	206/320
2010/0224532	A1 *	9/2010	Gonzalez	A45C 9/00	206/576
2010/0240427	A1 *	9/2010	Lee	H04B 1/3888	455/575.8
2010/0300909	A1 *	12/2010	Hung	B65D 25/00	206/320

OTHER PUBLICATIONS

U.S. Appl. No. 29/718,039, dated Dec. 20, 2019, 20 pages.
 LaCie: Rugged Boss SSD, Website: <https://www.youtube.com/watch?v=DjJYfBFyJoo>, dated Sep. 9, 2019.
 LaCie: Rugged RAID Pro, Website: <https://youtube.com/watch?v=DjJYfBFyJoo>, dated Apr. 8, 2018.
 LaCie: Rugged Thunderbolt USB-C, Website: https://www.youtube.com/watch?v=7R4078E_U2Y, dated Aug. 10, 2017.
 LaCie: Rugged USB-C, Website: <https://www.youtube.com/watch?v=Fkfc0Va8SDA>, dated Oct. 28, 2016.
 LaCie: Rugged Secure, Website: <https://www.youtube.com/watch?v=QR6jPq0MfUQ>, dated Jul. 20, 2018.
 Rugged Mini, Website: <https://www.youtube.com/watch?v=8ZJhKmBYXP8>, dated Jul. 18, 2011.
 ArmorATD from G-Technology, Website: https://shop.westerndigital.com/products/portable-drives/g-technology-armoratd-usb-3-1-hdd?utm_medium=pdsh2&utm_source=gads&utm_campaign=gtech-uspla&utm_content=304243658138&utm_term=0G10435-1#0G10433-1, dated Oct. 22, 2019.

G-Drive ev RaW from G-Techonolgy, Website: <https://shop.westerndigital.com/products/portable-drives/g-technology-g-drive-ev-raw-usb-3-0#0G04101>, dated Oct. 22, 2019.
 G-Drive ev ATC with Thunderbolt, Website: <https://shop.westerndigital.com/products/portable-drives/g-technology-g-drive-ev-atc-thunderbolt-hdd#0G03586>, dated Oct. 22, 2019.
 Sony PSZ-HCB Series Rugged, Website: https://www.adorama.com/sopszhh1tbc.html?gclid=EAIaIQobChMIh_GNp9yw5QIVuR-tBh2neg93EAQYASABEglMsfD_BwE, dated Oct. 22, 2019.
 Adata SD700, Website: <https://www.adata.com/us/feature/441>, dated Oct. 22, 2019.
 Adata SD710, Website: <https://www.adata.com/us/feature/478>, dated Oct. 22, 2019.
 LaCie: Rugged SSD and Rugged SSD Pro, Website: <https://www.youtube.com/watch?v=9SMx7O0vZQI>, dated Sep. 9, 2019.

* cited by examiner

Primary Examiner — Susan Moon Lee
 (74) Attorney, Agent, or Firm — Westman, Champlin & Koehler, P.A.

(57) CLAIM

The ornamental design for a storage device, as shown and described.

DESCRIPTION

FIG. 1 is a perspective view of a first embodiment of a storage device showing our new design;
 FIG. 2 is a front view thereof;
 FIG. 3 is a back view thereof;
 FIG. 4 is a right side view thereof, the left side view being identical;
 FIG. 5 is a top view thereof; and
 FIG. 6 is a bottom thereof;
 FIG. 7 is a front perspective view of a second embodiment of the storage device;
 FIG. 8 is a back perspective view of FIG. 7;
 FIG. 9 is a front view of FIG. 7;
 FIG. 10 is a back view of FIG. 7;
 FIG. 11 is a left side view of FIG. 7;
 FIG. 12 is a right side view of FIG. 7;
 FIG. 13 is a top view of FIG. 7; and
 FIG. 14 is a bottom view of FIG. 7.

The broken lines shown in the drawings are included for purposes of illustrating portions of the storage device and form no part of the claimed design.

1 Claim, 7 Drawing Sheets

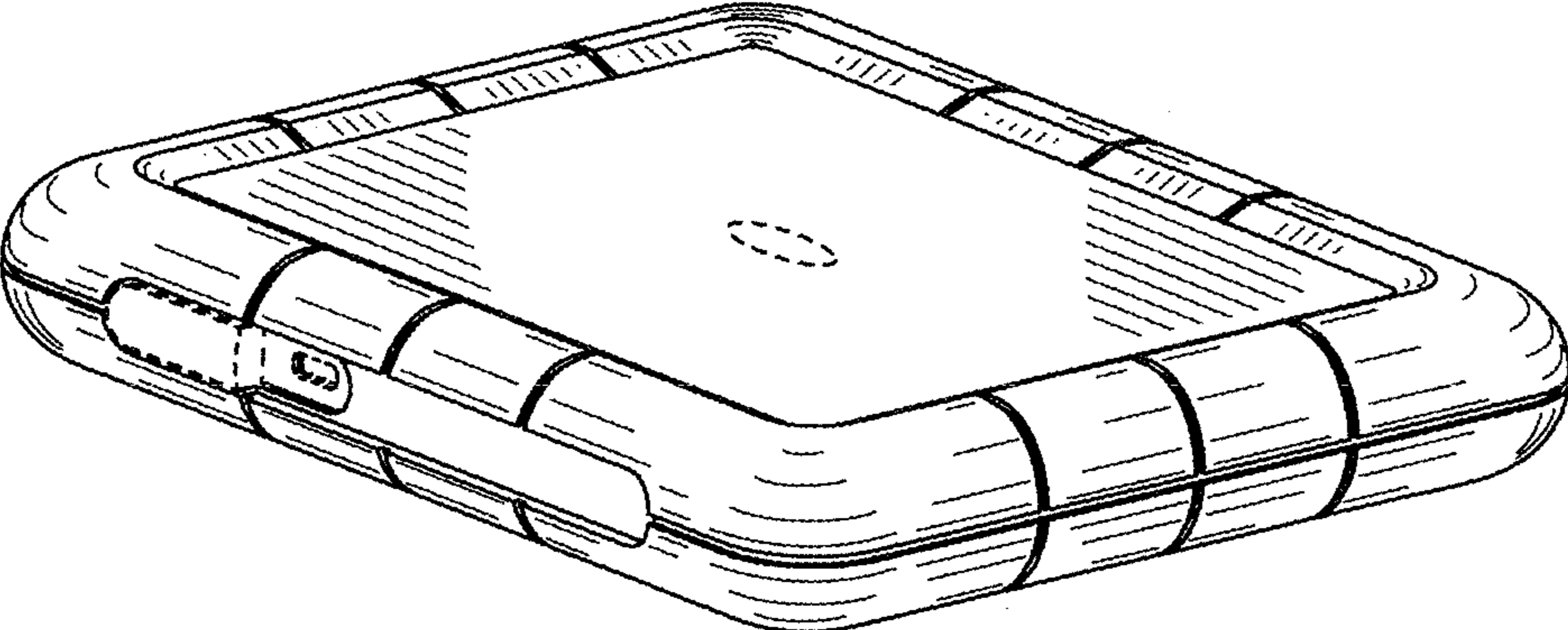

Fig. 1

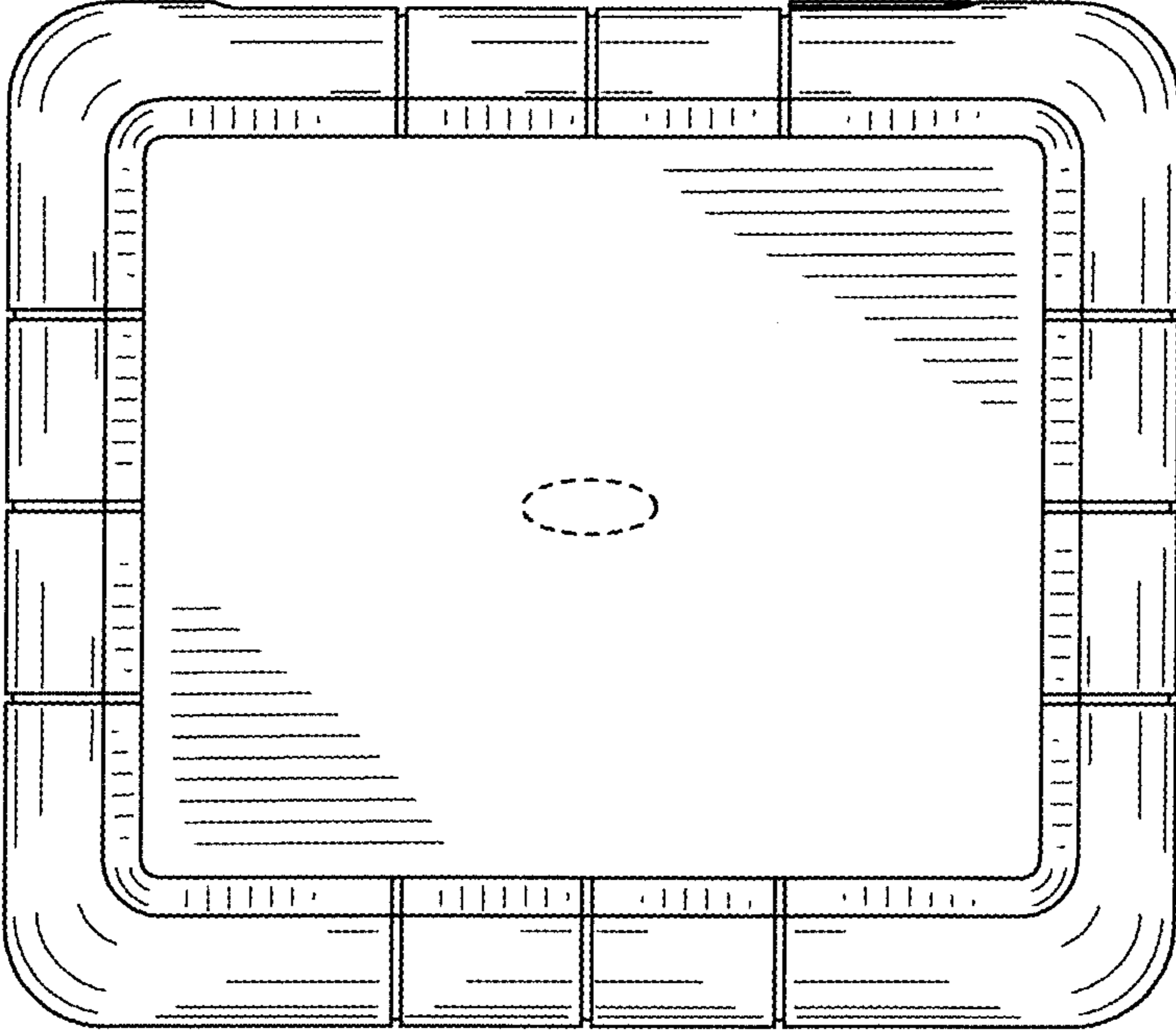

Fig. 2

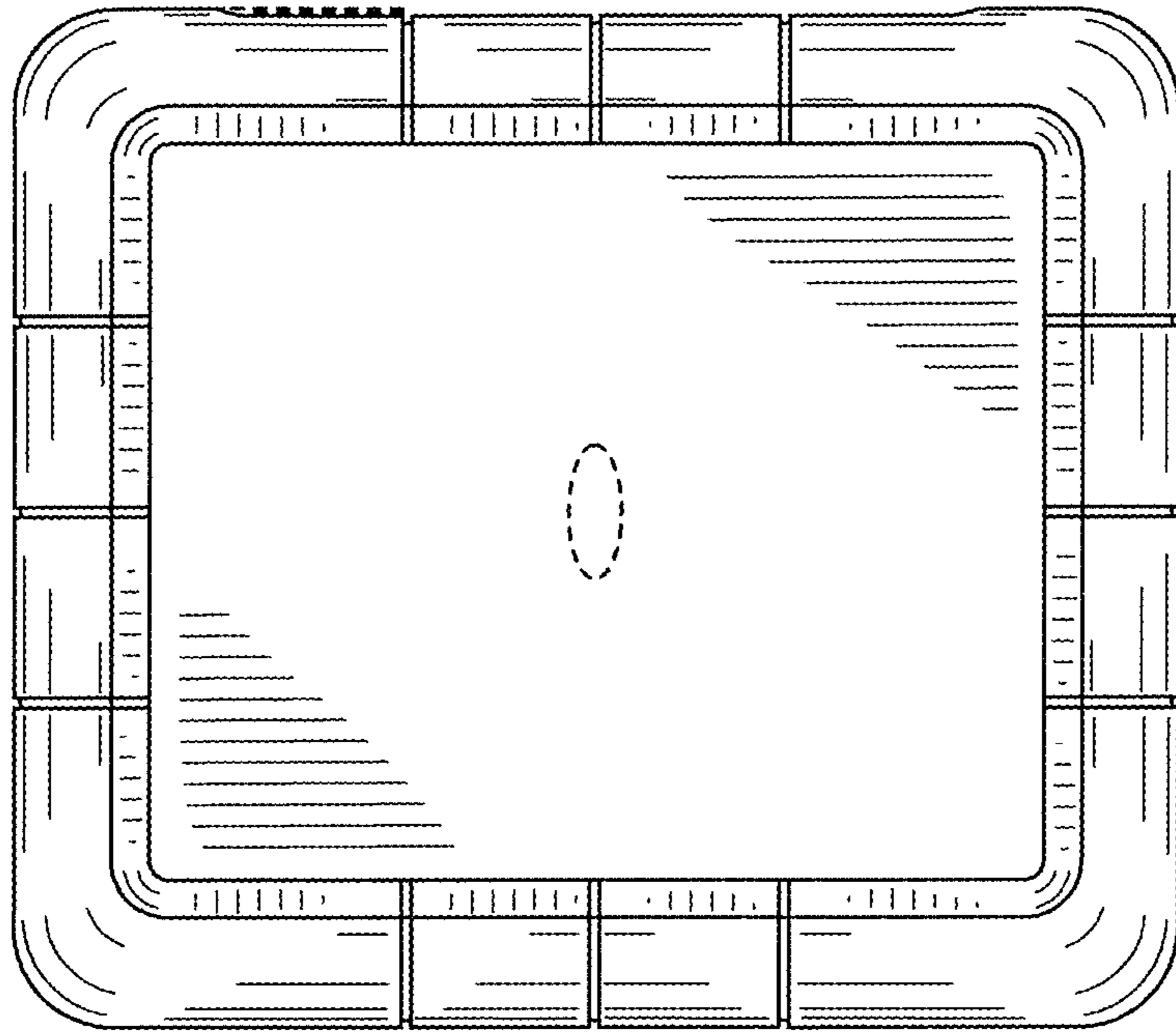

Fig. 3

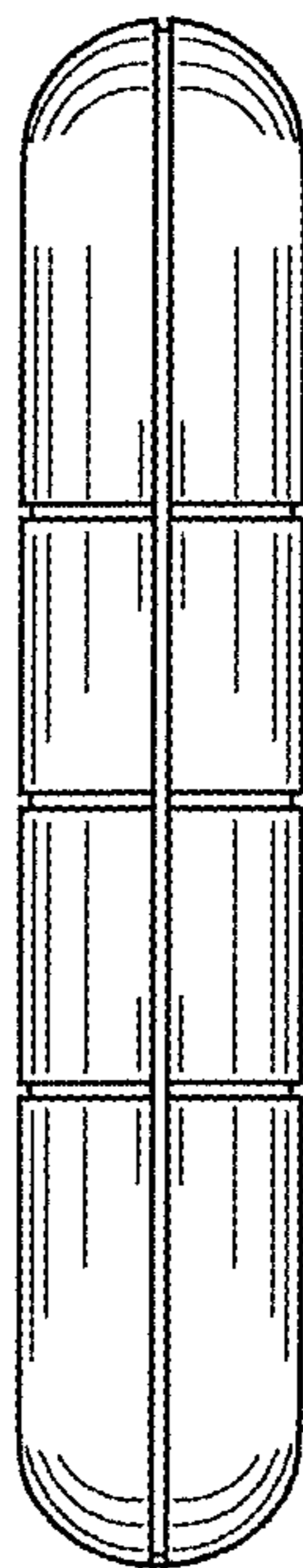

Fig. 4

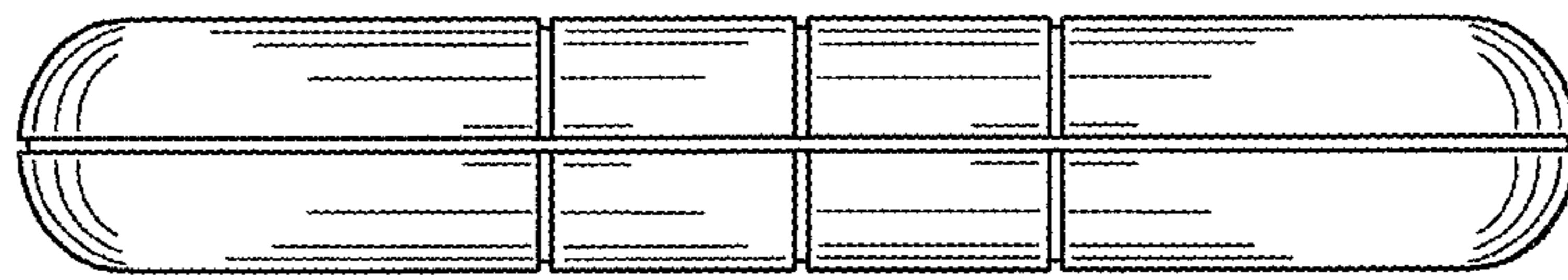

Fig. 5

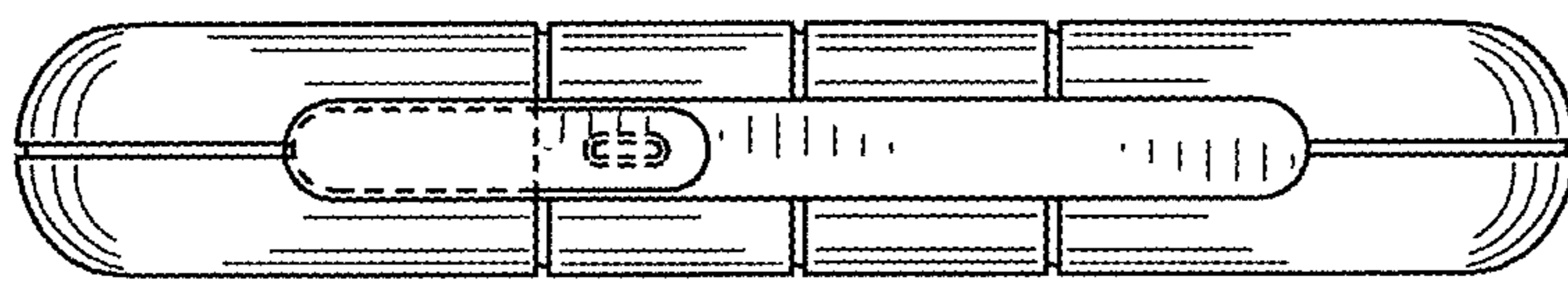

Fig. 6

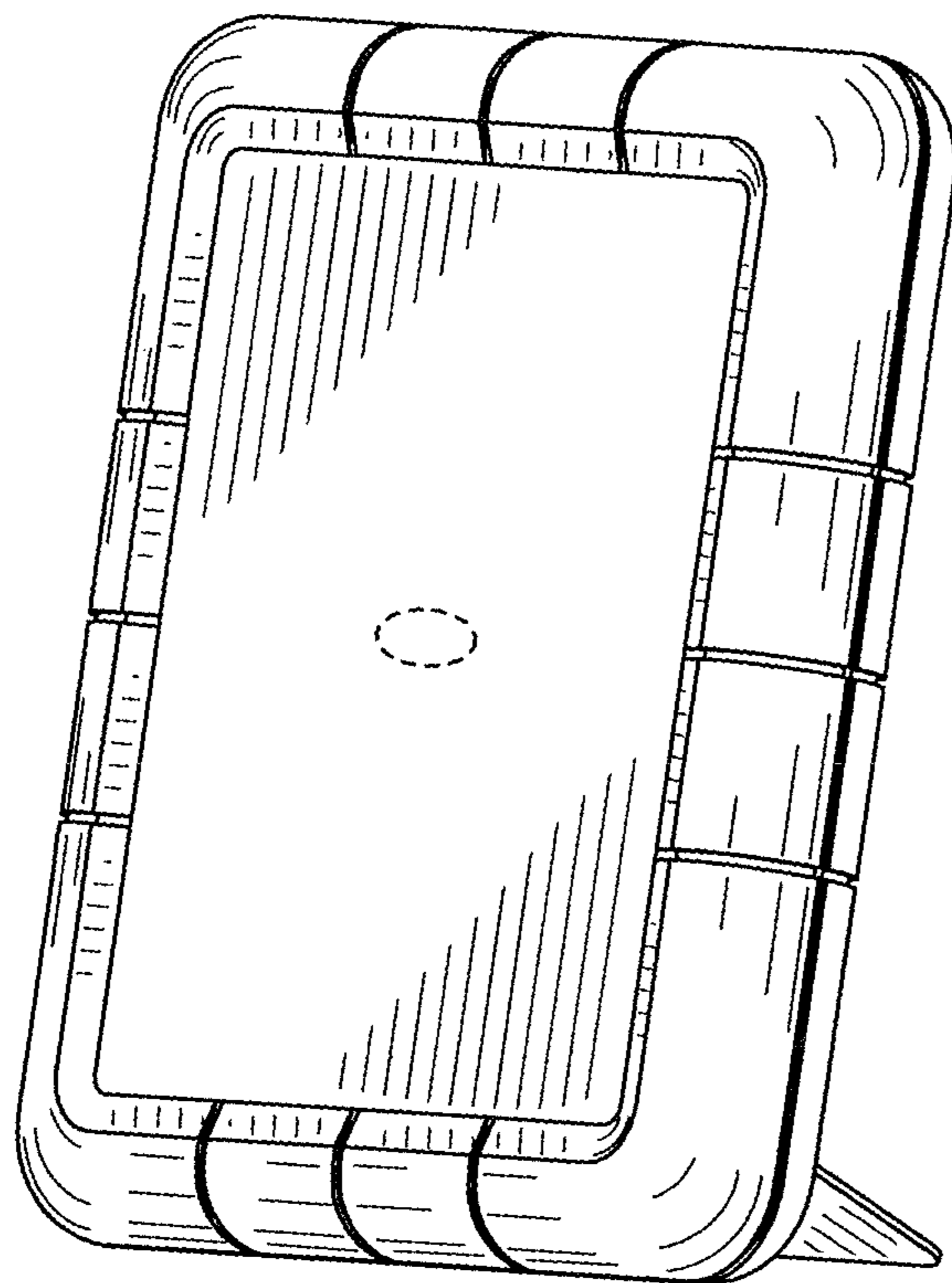

Fig. 7

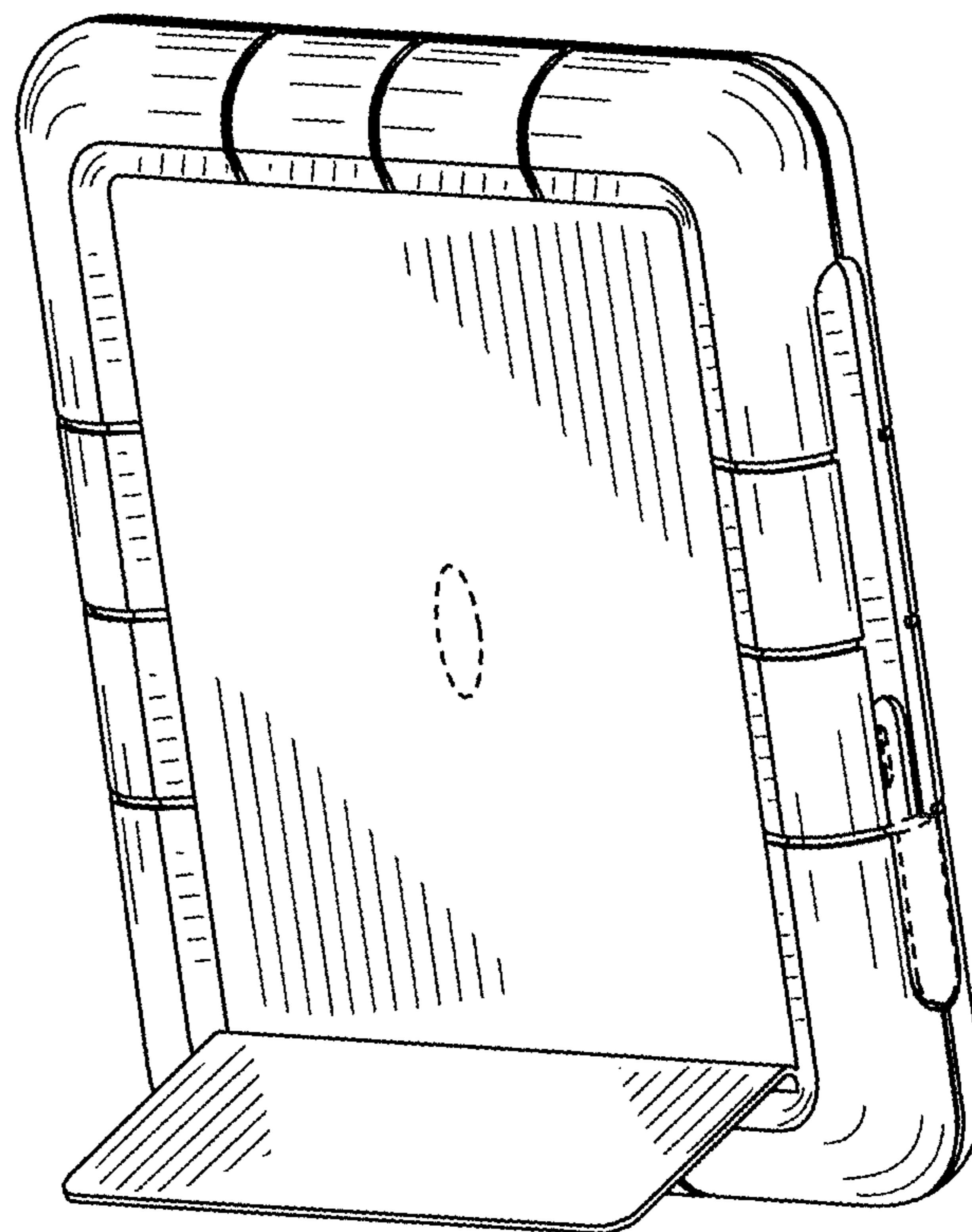

Fig. 8

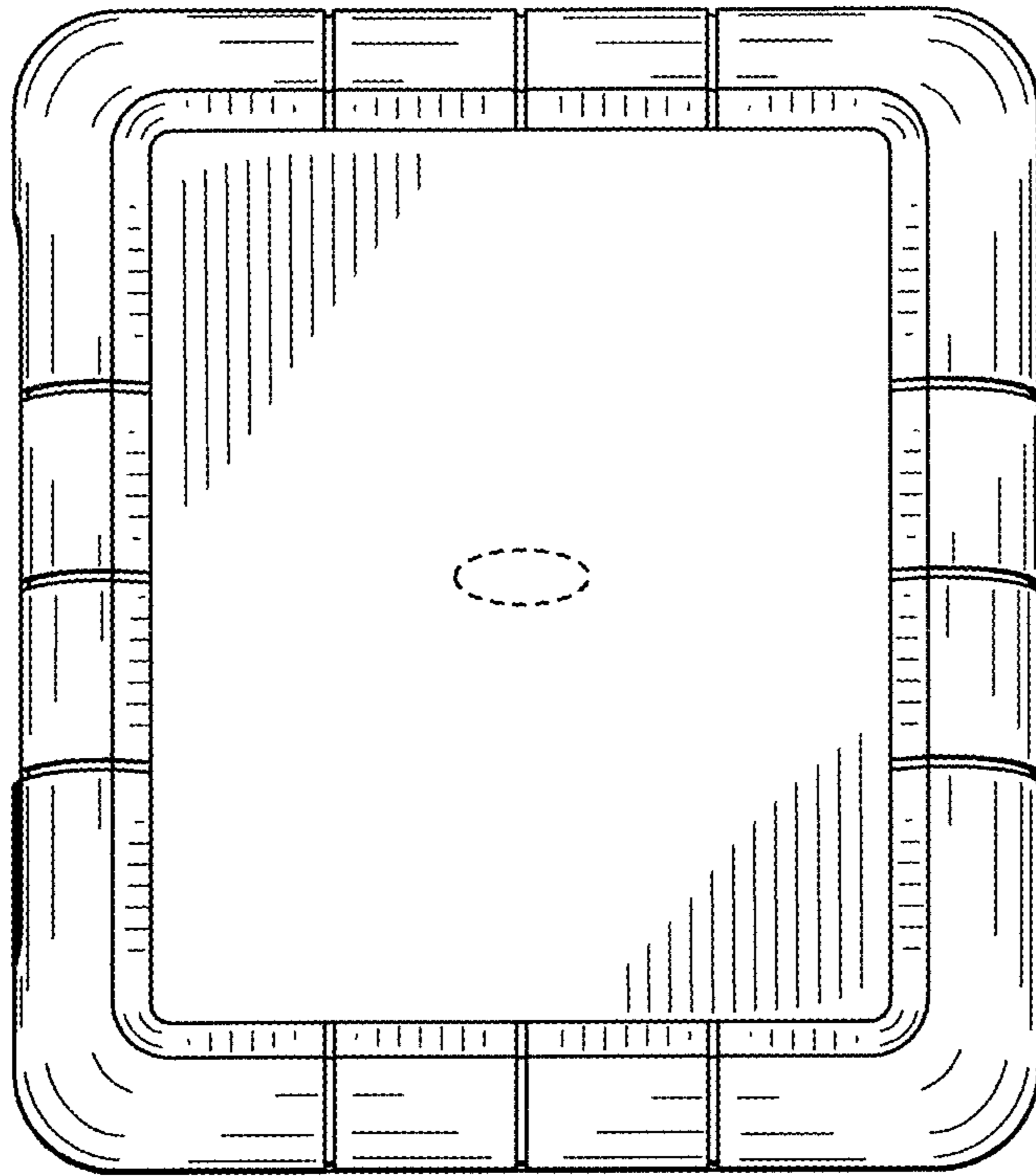

Fig. 9

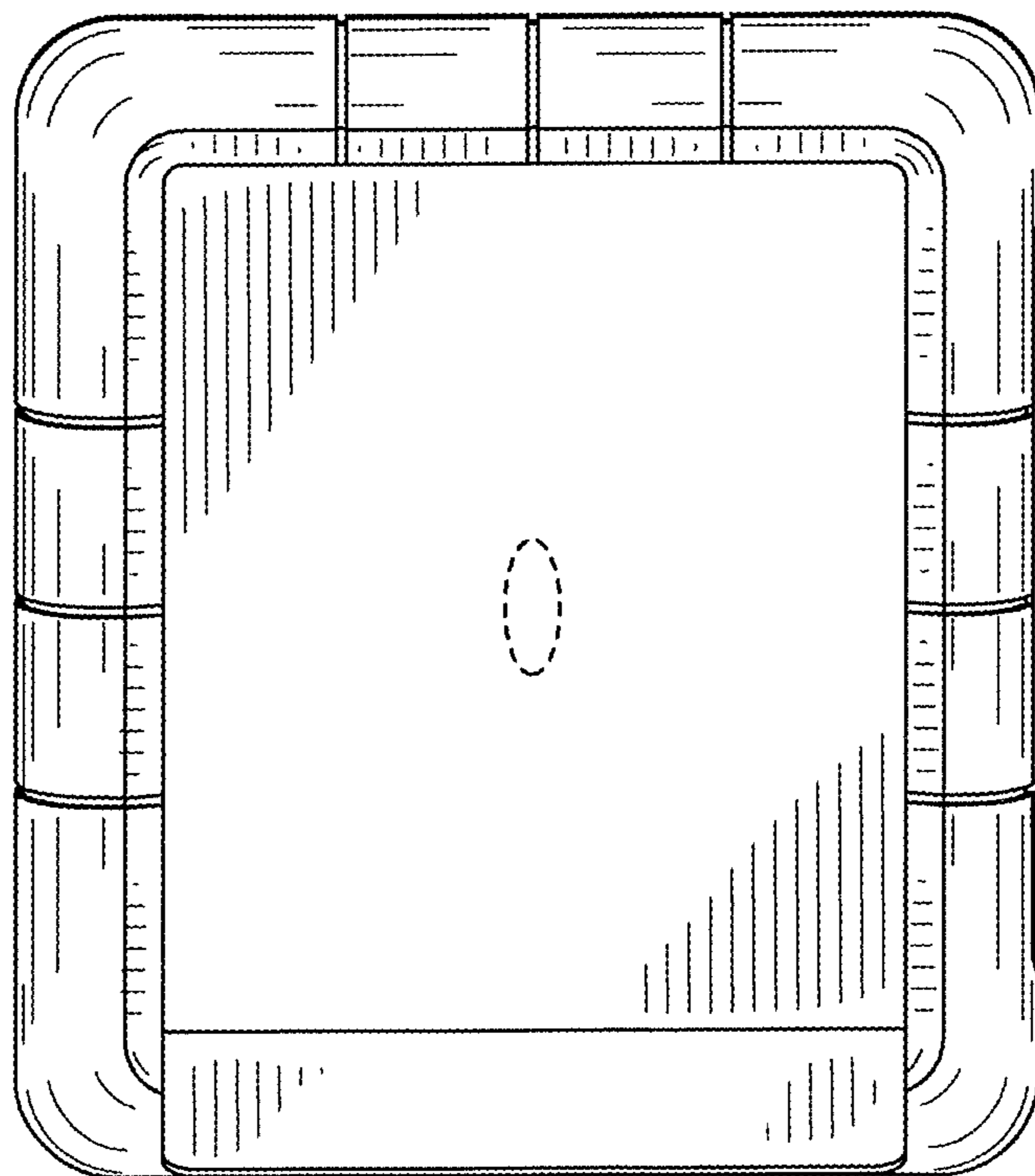

Fig. 10

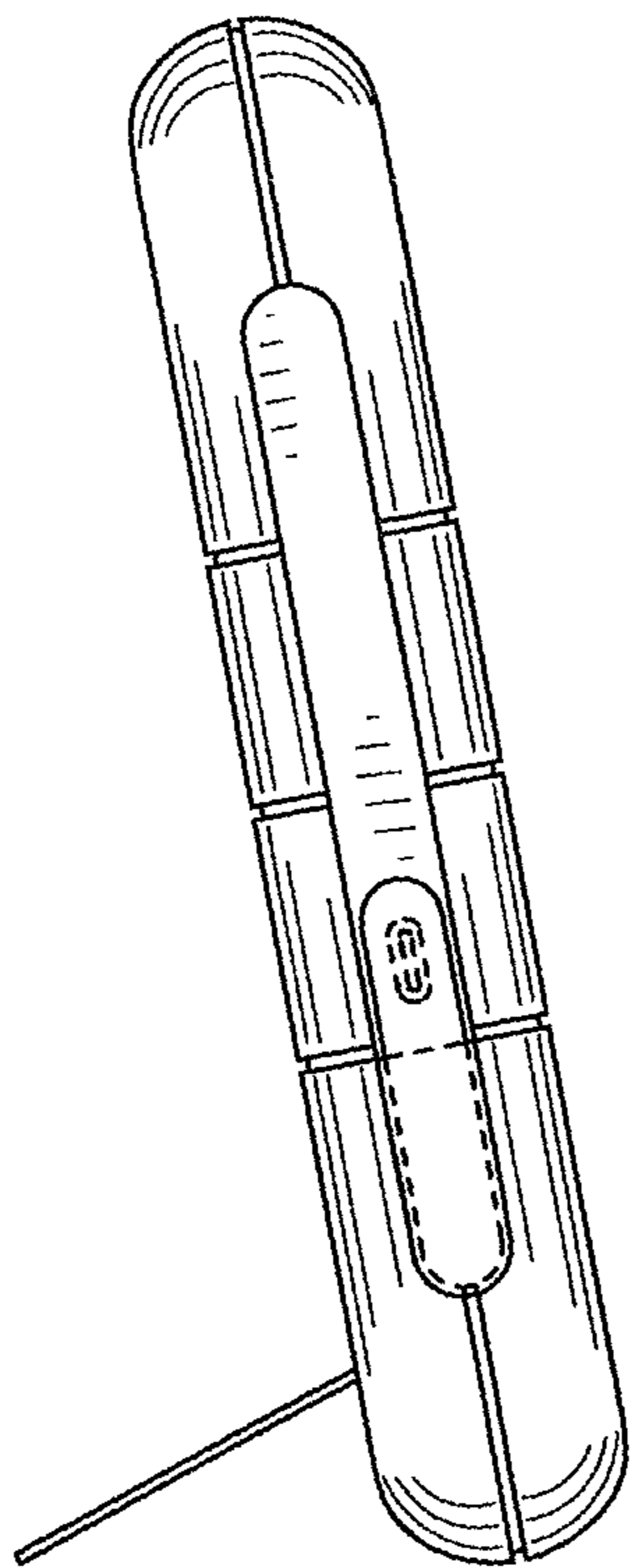

Fig. 11

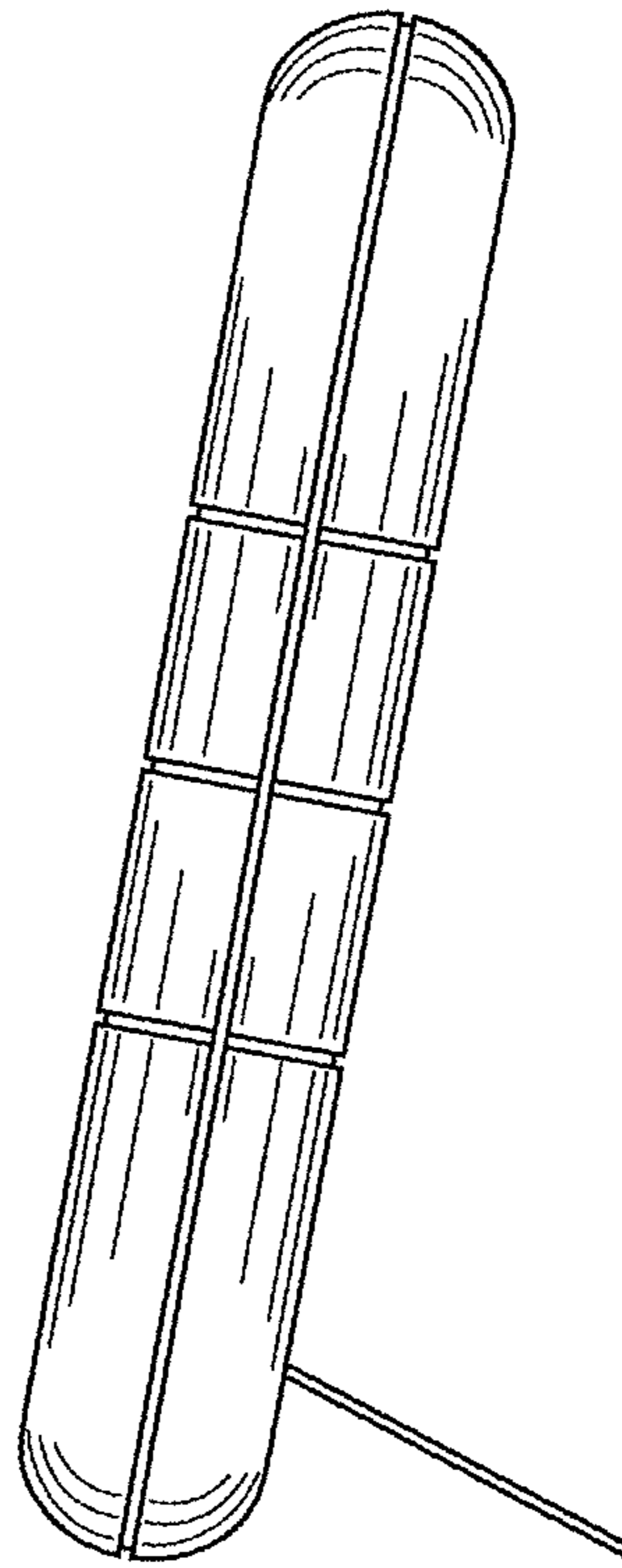

Fig. 12

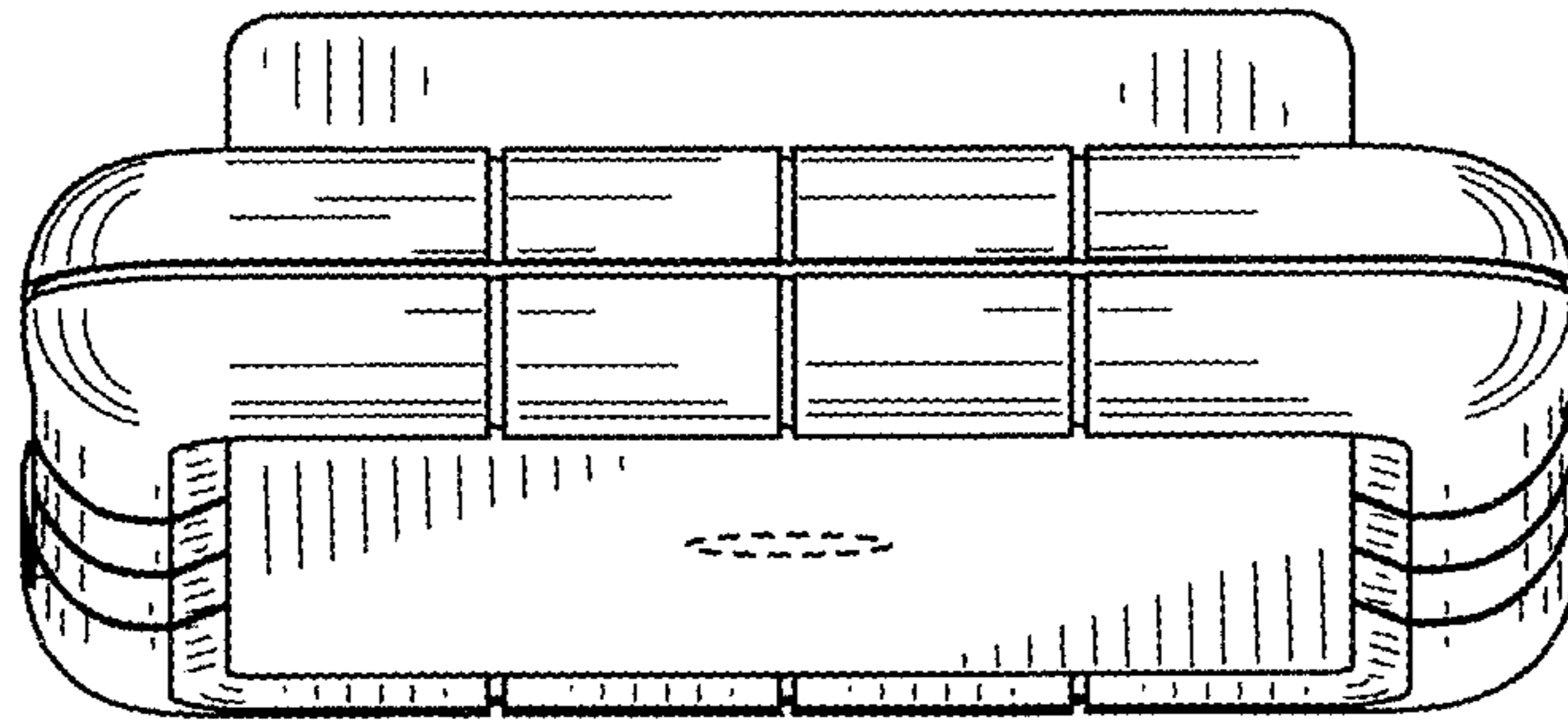

Fig. 13

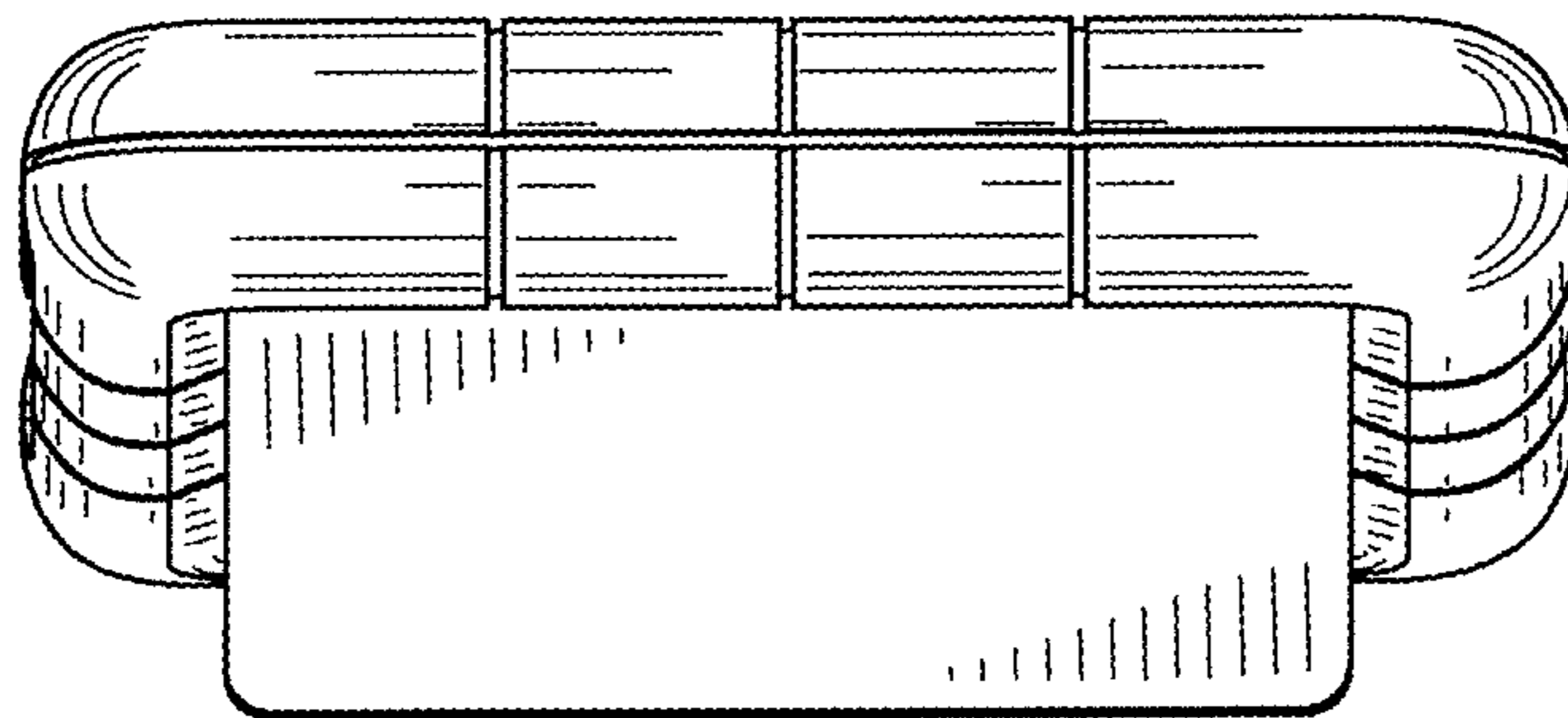

Fig. 14